

Traverse & Elevation Table

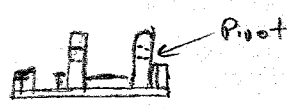

Trisser Mech Bottom

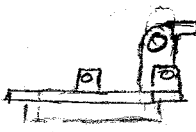
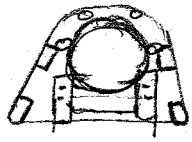
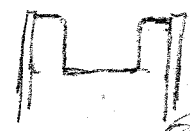
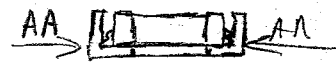
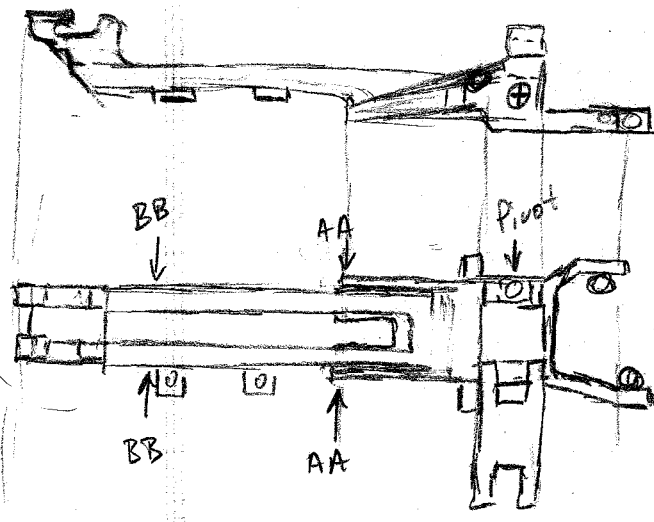
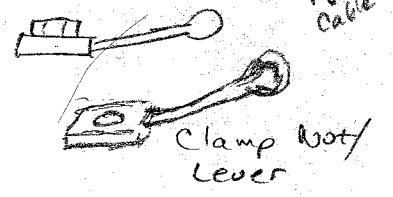
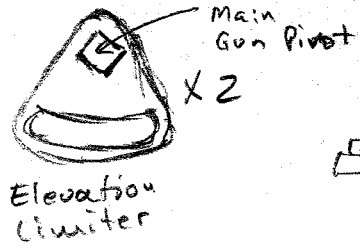
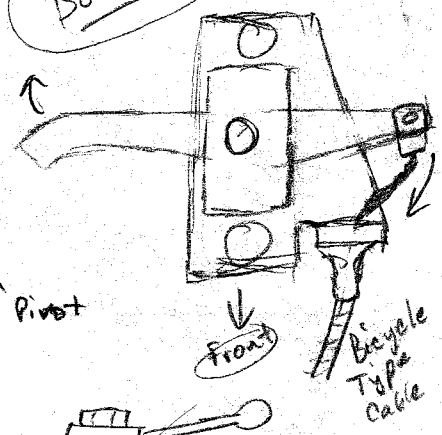

T&E Table

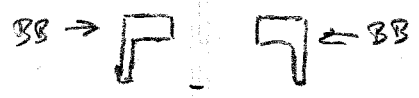
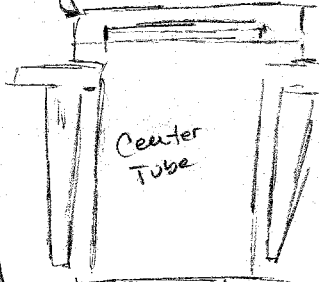

T&E Table goes out of this

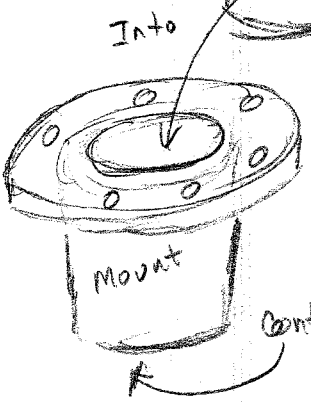
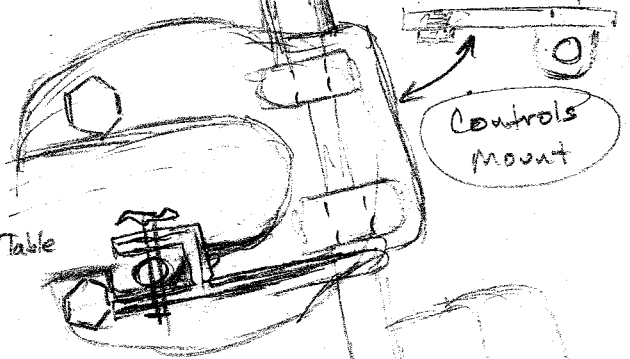
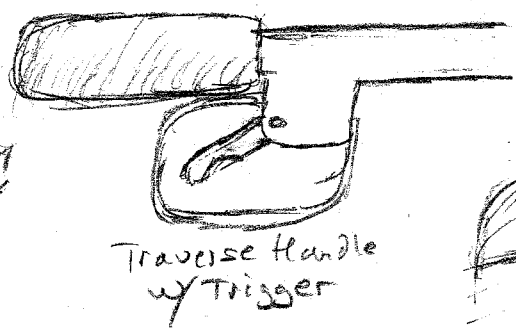
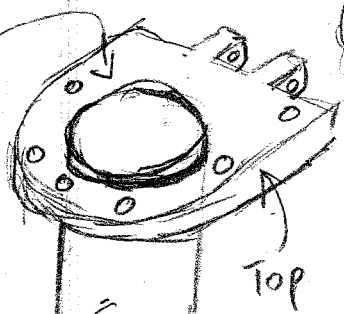

Center Tube

Hull Roof Leveler Piece

Center Tube



Elevation Handle



Actual Mount

Controls Mount

