

## FLUID SPILL CLEAN-UP KITS

- Single-use precaution kit for the safe and convenient clean-up, removal and disposal of potentially infectious body fluid spills including blood, vomit, urine and faeces
- Minimizes the risk of cross contamination, controls mold and mildew and neutralizes odours

### STANDARD KITS

- **Includes:**
  - Red-Z® fluid control solidifier powder 21 g
  - Disposable gloves
  - Clean-up scoop and scraper
  - Antimicrobial hand wipes
  - Absorbent wiper towel
  - Biohazard bag



SAY557

### DELUXE KITS

- **Includes same items as Standard Kits plus:**
  - Safety mask/eyeshield
  - Protective apron
  - Disinfection solution with wipe
  - Easy-to-follow universal instructions



SEE492

Model No.	Mfg. No.	Description	Price /Each
SAY557	14358	Standard Kit	9.53
SEE492	14360	Deluxe Kit	11.20

## MEDI-CAN™ STEP CANS

- Steel construction with a durable powder coated finish or non-magnetic stainless steel construction
- Foot pedal operation eliminates hand contact with lid
- Equipped with 3 1/2 gallon galvanized steel liner
- Vinyl base ring protects floors and reduces noise
- UL listed and FM approved fire safe and self-extinguishing
- Complies with OSHA standards and OBRA regulations



Model No.	Mfg. No.	Dimensions			Colour	Wt. lbs.	Price /Each
		Dia."	x	H"			
NI372	ST3.5EGLWH	11	x	17	White	9	142.00
NI373	ST3.5EGLRD	11	x	17	Red	9	142.00
NI374	ST3.5SSGL	11	x	17	Stainless	9	308.00

### BIOHAZARD DECAL

NI375	BP-1	6" Sq.	Red	-	9.30
-------	------	--------	-----	---	------

## RED-Z® FLUID SOLIDIFIER

- Absorbs and solidifies potentially hazardous body fluid spills including blood, vomit, urine and faeces
- Disinfects and neutralizes odours
- Absorbs up to 150 times its own weight
- Ideal for industrial/commercial facilities, hospitals, nursing homes, schools, transportation vehicles, ships, correctional facilities, laboratories, medical and dental offices, police departments, clinics and hotels
- 142 g bottle

Model No. SAY556

Mfg. No. 14364

Price/Each \$12.80



## SURE-GUARD™ BIO-MEDICAL WASTE LINERS

- Premium bio-hazard waste removal
- Printed with bold **BIO-MEDICAL WASTE**
- Constructed specifically for the safe containment and transport of infectious waste
- Noticeably more tough and puncture resistant than normal liners due to Sure-Guard™ liners being made with high grade virgin resins
- Can handle the toughest abatement, restoration, environmental and industrial applications
- Sure-Tie® drawstring closure available for ultimate personal protection and waste containment
- Ideal for industrial/commercial facilities, hospitals, ambulances, nursing homes, schools, transportation vehicles, correctional facilities, laboratories, medical and dental offices



JD098



Priced per Case

Model No.	Size"	Colour	Qty /Case	Price /Each
JD098	55 x 74	Red	100	226.00
JD104	55 x 74	Yellow	50	118.00
JD099	21.5 x 29	Yellow	200	76.00
JD100	30 x 38	Red	100	63.30
JD101	30 x 38	Yellow	100	63.30
JD102	37 x 50	Red	100	89.90
JD103	39 x 46	Yellow	100	89.90

## SURE-GUARD™ ASBESTOS REMOVAL LINERS

- Constructed in three cross linked layers of film
- Specifically designed for the rigours of asbestos abatement
- Noticeably more tough and puncture resistant than normal liners due to Sure-Guard™ liners being made with high grade virgin resins
- Ideal for the toughest abatement, restoration, environmental, and industrial applications



JD069

Priced per Case

Model No.	Size"	Colour	Qty /Roll	Price /Each
JD069	26 x 40	Clear	100	88.80
JD070	26 x 40	Yellow	100	85.70
JD071	35 x 50	Clear	100	155.00
JD072	35 x 50	Yellow	100	150.00
JD073	48 x 60	Yellow	50	236.00

## SAFECROSS® CPR FACE SHIELDS

- Single-use physical protection barrier
- Helps reduce the risk of cross contamination and transference of viruses and bacteria between the victim and rescuer in situations where mouth-to-mouth assistance is required
- Includes a specially designed viral and bacterial filter for extra protection
- Also used as a CPR training aid to protect against cross contamination

**Model No. SAY563**  
**Mfg. No. 17745**  
**Price/Each \$2.31**



## SAFECROSS® CPR FACESHIELD KITS

- Packaged in a water-resistant pouch with key ring
- Contains the following:  
 CPR face shield  
 One pair of size large vinyl disposable gloves
- Easily attaches to a key chain for use in emergency situations

**Model No. SAY566**  
**Mfg. No. 17763**  
**Price/Each \$4.97**

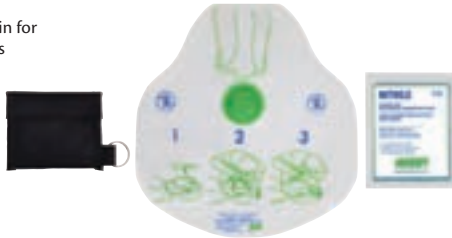

## CPR PROTECTIVE DEVICES

- Single-use physical protection barrier to prevent the victim's breath and bodily fluids from reaching the rescuer
- Semi-transparent medical-grade PVC
- Innovative construction includes a specially designed viral and bacterial filter for extra protection

**Model No. SAY567**  
**Mfg. No. 17738**  
**Price/Each \$4.97**



## SAFECROSS® CPR POCKET FACE MASKS

- Reusable medical grade thermo-plastic physical protection barrier to prevent the victim's breath and bodily fluids from reaching the rescuer
- Innovative construction includes a specially designed viral and bacterial filter for extra protection
- Features a soft inflated cuff for a leak-proof seal
- Includes an oxygen inlet for optional supplemental oxygen
- Model **SAY571** CPR pocket face mask kit includes:  
 CPR pocket face mask  
 One pair of vinyl gloves  
 One antimicrobial hand towelette



Model No.	Mfg. No.	Description	Price /Each
SAY569	17746	Safecross® CPR pocket face mask in hard case	14.00
SAY570	17747	Replacement one way valve	3.97
SAY571	17744	CPR pocket face mask kit	15.90

## CPR FACE SHIELDS IN POUCH WITH KEY RING

- Convenient key chain pouch contains CPR face shield
- Easily attaches to a key chain for use in emergency situations



Model No.	Mfg. No.	Colour	Price /Each
SAY564	17750	Black	3.97
SAY565	17765	Red	3.97

## NITRILE MEDICAL EXAMINATION GLOVES

- Ambidextrous, disposable nitrile medical examination gloves minimize contact between the caregiver and patient
- Prevents direct contact with blood and other bodily fluids
- Offers high puncture resistance and increased tactile strength
- Essential for all first aid and emergency needs
- Conveniently packaged in pairs
- Pre-powdered

**Model No. SEE697**  
**Mfg. No. 18765**  
**Price/Each \$0.65**



## GLOVE POUCHES

- Constructed of lightweight, 600-denier polyester with a waterproof backing
- Slim, durable pouches feature fast-stick closures and include a key ring
- Easy to carry on a belt, attach to a key ring, or store in a pocket, purse or backpack
- Ideal for rescuers, first aiders, police, fire fighters, security and health care personnel
- Provides easy access in emergency situations
- Each pouch contains 2 pairs of large vinyl gloves

**Model No. SAY562**  
**Mfg. No. 18105**  
**Price/Each \$5.19**



## EMERGENCY RESUSCITATOR KITS

- Emergency resuscitator kit for fast response to emergency breathing situations
- Includes items to help reduce the risk of cross contamination and transference of viruses and bacteria between the victim and rescuer
- Packaged in a water-resistant plastic container, complete with carrying handle and wall-mounting apparatus

**Model No. SAY572**  
**Mfg. No. 01435**



Price/Each \$25.70

## OXYGEN THERAPY KITS

- For emergency medical personnel and first aid providers
- Ideal for hospital, industrial and home use
- Kit contains the following:
  - adjustable flow regulator (0 – 25 litres per minute)
  - disposable oxygen mask with tubing
  - cylinder on/off wrench
  - 425 litre capacity aluminum cylinder (full)
  - Cordura® oxygen bag

**Model No. SAY574**  
**Mfg. No. 17391**  
**Price/Each \$811.00**



## AMBU® SPUR® RESUSCITATORS

- Provides safe and effective artificial ventilation during respiratory arrest
- Portable bag-valve-mask resuscitator for use with or without supplemental oxygen
- Pressure limiting valve prevents over-inflation
- Integrated handle for user comfort and uniform compression
- Easy-to-grip surface ensures secure handling and optimum stroke volumes with just one hand
- Standard 15/22 mm patient connector allows direct connection to common devices
- Complete with a reservoir bag

**Model No. SAY573**  
**Mfg. No. 17701**  
**Price/Each \$46.10**



## OXYGEN MASKS

- Complete with 2.1 m (7') PVC oxygen tubing and a polypropylene connector
- Adult size
- PVC construction, elongated-style clear mask with a soft aluminum nose piece



Model No.	Mfg. No.	Description	Price /Each
SAY575	17757	For medium concentration of oxygen delivery	4.03
SAY576	17753	Features a single one-way valve and one open vent. Includes reservoir bag	5.55
SAY577	17755	Features dual one-way valves. Includes reservoir bag	5.49

## LAERDAL V-VAC™ SUCTION STARTER KITS

- Portable emergency unit for suctioning fluids and vomit from a patient's airway
- Small and lightweight; offers one-handed operation
- Each kit contains:
  - One handle
  - Two cartridges
  - One catheter adapter
  - One suction catheter
  - One double male connector



Model No.	Mfg. No.	Description	Price /Each
SAY578	17370	Kit	249.00
SAY579	17372	Replacement cartridge for V-VAC™ Suction Unit	45.80

## GUEDEL-TYPE AIRWAY KITS

- For use on an unconscious patient to maintain an airway, suction fluids and depress a victim's tongue to prevent airway blockage
- Bite locks are colour-coded for quick identification according to universally established standards
- Includes sizes 40 mm to 110 mm (8/kit)

**Model No. SEE885**  
**Mfg. No. 17579**  
**Price/Each \$19.20**



## AMMONIA INHALANT AMPOULES

- Smelling salts for nasal inhalation
- For the prevention and treatment of fainting and dizziness

• 10 units per box  
**Model No. SAY581**  
**Mfg. No. 14194**  
**Price/Each \$5.99**



## INSTA-GLUCOSE® ORAL GEL

- Concentrated sugar in gel form for oral treatment of insulin shock
- Provides a rapid increase in blood sugar concentration
- 31 g (single dosage)

**Model No. SAY582**  
**Mfg. No. 14426**  
**Price/Each \$9.84**







## PADLOCK SECURITY FEATURES

### SECURITY LEVEL

PHYSICAL SECURITY	Higher						Lower
<b>Cut Resistance</b>							
Shackle Material	Shackle Shroud	Boron Alloy	Hardened Steel	Steel			Brass
Shackle Diameter	7/16"	3/8"	5/16"	1/4"			3/16"
<b>Pick Resistance (No. of Tumbler Pins)</b>	10-Pin	6-Pin	5-Pin	4-Pin	3-Pin	Warded	
<b>Shackle Locking Mechanism</b>	Dual Ball Bearing		Dual Lever		Single Lever		
<b>Lock Body Material</b>	Solid Steel	Laminated Steel		Aluminum			
<b>Weather Resistance</b>	Covered	Brass, Aluminum		Laminated Brass	Laminated Steel		

### KEYING OPTIONS:

#### Keyed Different:

Padlocks with a different operating key for each lock.



#### Keyed Alike (KA):

Sets of padlocks can be opened by the same key for added convenience. Stock KA numbers listed below. Contact us for additional KA numbers.



#### Master Keyed:

Padlocks with a different operating key for each lock, and with a single key that opens all locks for supervisory access. Contact us for additional information.



#### Removable Cylinder:

Permits replacing the key and cylinder without requiring a new padlock.



## MAXIMUM SECURITY

Solid steel padlocks offer the highest protection of hardened steel. Our padlocks come in a wide range of widths, with shackle lengths and diameters to fit any application --great for outdoor protection of commercial buildings, industrial plants and perimeter, remote and unattended properties and high risk areas.

### MASTER LOCK HIDDEN SHACKLE PADLOCKS & HIGH SECURITY HASPS (REKEYABLE)

The hockey puck-style lock design completely surrounds the 3/8" dia. shackle for high-security pry and cut resistance. Our industrial-strength padlocks are keyable and have replaceable cylinders and shackles.

- These padlocks offer maximum protection against drilling, sawing, prying, crowbar, dent pullers and hammers
- 6-pin tumbler cylinders provide superior pick resistance, with tens of thousands of key changes available
- Secure vans, trucks, gates, garages, storage buildings and vending machines
- Locks come with two keys. For keyed alike options and master keying, please call us today
- Combined with high-security hasps (SAO687); designed to completely surround the lock; it make the locks virtually impervious to physical attacks



SAO688

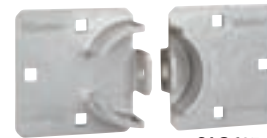

SAO687

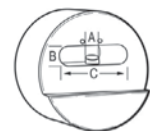

Model No.	Mfg. No.	Description	Body Size		Body Material	Shackle Clearance			Shipping Weight (lbs.)	Price /Each
			Width"	Thickness"		A"	B"	C"		
SAO688	6270	Lock	2 7/8	1 1/4	Steel	3/8	1 9/32	1 23/32	2.20	62.60
SAO687	770	Hasp	9 x 4 1/2	1/4	Steel	N/A	N/A	N/A	3.00	39.20

### MASTER LOCK SOLID STEEL PADLOCKS (REKEYABLE)

- Constructed of hardened, chrome-plated solid steel bodies that resist cutting, sawing and corrosion
- Hardened boron alloy steel shackles offer superior cut resistances while dual ball bearing locking mechanism resists pulling and prying attacks
- 5-pin Pro Series® cylinders provide tens of thousands of key changes
- Special spool pin tumblers are virtually impossible to pick
- Rekeyable - replaceable cylinder and shackle
- Locks come with two keys
- For keyed alike options and master keying, please call us



SN708



SAL442

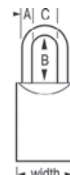

Model No.	Mfg. No.	Body Size		Body Material	Shackle Clearance			Shipping Weight (lbs.)	Price /Each
		Width"	Thickness"		A"	B"	C"		
SN708	6230	2 1/2 Round	1 1/8	Hardened Steel	7/16	1 1/8	7/8	1.40	45.90
SEJ510	7050	2	1	Hardened Steel	3/8	1 1/2	29/32	0.85	36.40
SAL442	7040	1 3/4	1	Hardened Steel	5/16	1 3/16	29/32	0.75	30.60

### MASTER LOCK SOLID STEEL SHROUDED PADLOCKS (REKEYABLE)

- Shrouded shackles provide superior resistance to cutting by minimizing shackle exposure to physical attacks

Model No.	Mfg. No.	Body Size		Body Material	Shackle Clearance			Shipping Weight (lbs.)	Price /Each
		Width"	Thickness"		A"	B"	C"		
SN707	7045	1 3/4	1	Hardened Steel	5/16	1 3/16	29/32	0.90	53.40
SN715	7035	1 9/16	13/16	Hardened Steel	1/4	1 1/16	25/32	0.80	51.20

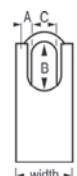

SN707



## MASTER LOCK PRO SERIES® SOLID BRASS PADLOCKS (REKEYABLE)

- Solid brass body construction resists corrosion - ideal for harsh environments
- Hardened boron alloy steel shackles offer superior cut resistances while dual ball bearing locking mechanism resists pulling and prying attacks
- 5-pin Pro Series® cylinders provide tens of thousands of key changes
- Special spool pin tumblers are virtually impossible to pick
- Rekeyable - replaceable cylinder and shackle
- Locks come with two keys
- For keyed alike options and master keying, please call us



SAL507

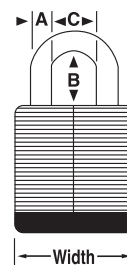

Model No.	Mfg. No.	Body Size		Body Material	Shackle Clearance			Shipping Weight (lbs.)	Price /Each
		Width"	Thickness"		A"	B"	C"		
SAL507	6840	1 3/4	1	Solid Brass	5/16	1 3/16	29/32	0.80	31.90
SAL508	6830	1 9/16	15/16	Solid Brass	1/4	1 1/16	25/32	0.70	27.10

## MASTER LOCK RESETTABLE BRASS COMBINATION PADLOCKS

- Easy "Set-your-Own" 4-digit combination with up to 10 000 combinations available
- Strong, solid brass case construction resists corrosion - ideal for harsh environments
- Heavy hardened steel shackles provide high resistance to cutting and prying
- Model SEJ513 features a key override providing immediate access to supervisors in the field
- SEJ514 control key sold separately



SAS366



SEJ513

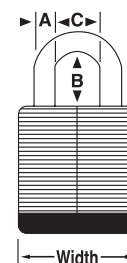

Model No.	Mfg. No.	Body Size		Body Material	Shackle Clearance			Shipping Weight (lbs.)	Price /Each
		Width"	Thickness"		A"	B"	C"		
SAS366	T175	2	1	Brass Casing	5/16	1	1	0.60	33.00
SAG162	175LH	2	1	Brass Casing	5/16	2 1/4	1	0.70	37.20
SEJ513	176	2	15/16	Brass Casing	5/16	1	1	0.60	36.30
SEJ514	K176	Control Key		Brass	-	-	-	0.02	5.52

## MASTER LOCK PROSERIES® RESETTABLE BRASS COMBINATION PADLOCKS

- Easy "Set-your-Own" 4-digit combination with larger ergonomic dials
- Strong, solid brass case construction resists corrosion with weather seal top around shackles
- Boron hexagonal shackle design increases cut resistance
- No reset tool required. Simple shackle manipulation to change combinations
- LH shackle option available for increased shackle clearance



SEJ515

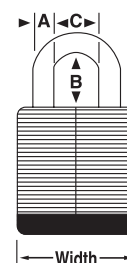

Model No.	Mfg. No.	Body Size		Body Material	Shackle Clearance			Shipping Weight (lbs.)	Price /Each
		Width"	Thickness"		A"	B"	C"		
SEJ515	1175	2 1/4	1 3/16	Brass Casing	3/8	1 1/16	15/16	0.70	35.10
SEJ516	1175LH	2 1/4	1 3/16	Brass Casing	3/8	2	15/16	0.71	39.30

## ECONOMY V-LINE BRASS PADLOCKS (NON-REKEYABLE)

- Solid brass body and cylinder construction resists corrosion - ideal for harsh environments
- Case hardened shackle resists sawing and filing
- Pin tumbler cylinder provides greater pick resistance
- Locks come with two keys. For keyed alike options, please call us



SAS395

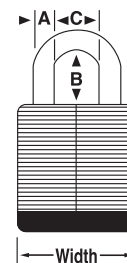

Model No.	Mfg. No.	Key Type	Body Size		Body Material	Shackle Clearance			Shipping Weight (lbs.)	Price /Each
			Width"	Thickness"		A"	B"	C"		
SAS395	4120	Different	3/4	3/8	Solid Brass	5/32	5/8	7/16	0.10	3.58
SAS396	4120KA	Alike	3/4	3/8	Solid Brass	5/32	5/8	7/16	0.10	4.85
SAS397	4130	Different	1 1/8	1/2	Solid Brass	3/16	9/16	9/16	0.20	5.34
SAS398	4130KA	Alike	1 1/8	1/2	Solid Brass	3/16	9/16	9/16	0.20	6.63
SAS015	4140	Different	1 1/2	1/2	Solid Brass	1/4	13/16	13/16	0.30	7.16
SAS400	4140KA	Alike	1 1/2	1/2	Solid Brass	1/4	13/16	13/16	0.30	8.45
SAS401	4150	Different	1-7/8	9/16	Solid Brass	9/32	15/16	1	0.40	10.80
SAS402	4150KA	Alike	1-7/8	9/16	Solid Brass	9/32	15/16	1	0.40	12.50

# LOCKS & LOCKOUT DEVICES

## ALL WEATHER RESISTANT PADLOCKS

The covered padlocks withstand even the harshest outdoor environments and corrosive atmospheres. These locks are excellent in perimeter security, storage buildings, and gate security and transportation.

### MASTER LOCK PRO SERIES<sup>®</sup> WEATHER TOUGH<sup>™</sup> SECURITY PADLOCKS (REKEYABLE)

- Constructed of hardened, chrome rustproofed steel laminated bodies that resist cutting, sawing and corrosion
- Durable thermal plastic covers protect the body of the lock from dirt, dust and other contaminants
- Hardened boron alloy steel shackles offers superior cut resistances while dual ball bearing locking mechanism resists pulling and prying attacks
- 5-pin Pro Series<sup>®</sup> cylinders provide tens of thousands of key changes
- Special spool pin tumblers are virtually impossible to pick
- Rekeyable - replaceable cylinder and shackle
- Locks come with two keys
- For keyed alike options and master keying, please call us

SAL433



SA903

**Master Lock**

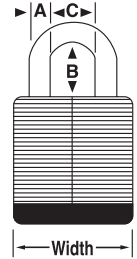

Model No.	Mfg. No.	Key Type	Body Size		Body Material	Shackle Clearance			Shipping Weight (lbs.)	Price /Each
			Width"	Thickness"		A"	B"	C"		
SAL433	6121	Different	2 1/8	1	Laminated Steel	5/16	1 1/8	7/8	1.00	35.80
SAL434	6121LJ	Different	2 1/8	1	Laminated Steel	5/16	2 1/2	7/8	1.05	39.00
SA902	6125	Different	2 3/8	1 3/16	Laminated Steel	3/8	1 3/8	7/8	1.20	41.50
SA903	6125KA	Alike	2 3/8	1 3/16	Laminated Steel	3/8	1 3/8	7/8	1.20	42.80

### MASTER LOCK LAMINATED STEEL SHROUDED PADLOCKS (REKEYABLE)

- The High Security - Weather Tough<sup>®</sup> padlock's iron shroud protects the shackle from cutting and prying while the heavy-duty laminated steel body construction withstands physical attacks

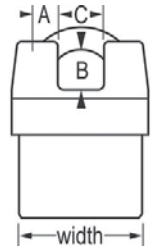

Model No.	Mfg. No.	Key Type	Body Size		Body Material	Shackle Clearance			Shipping Weight (lbs.)	Price /Each
			Width"	Thickness"		A"	B"	C"		
SA904	6325	Different	2 3/8	1 3/16	Laminated Steel	3/8	3/4	7/8	1.60	58.30
SA905	6325KA	Alike	2 3/8	1 3/16	Laminated Steel	3/8	3/4	7/8	1.60	59.50
SEJ517	6321	Different	2 1/8	1	Laminated Steel	5/16	3/4	7/8	1.40	49.30

### MASTER LOCK ECONOMY WEATHER PADLOCKS (NON-REKEYABLE)

- 1 9/16" laminated steel body construction for superior strength
- High-tech thermoplastic shell designed to protect and withstand the elements
- Hardened steel shackle
- Locks come with two keys
- Ideal for all outdoor applications

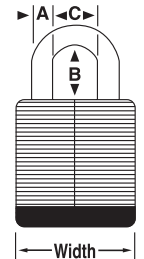

Model No.	Mfg. No.	Key Type	Body Size		Body Material	Shackle Clearance			Shipping Weight (lbs.)	Price /Each
			Width"	Thickness"		A"	B"	C"		
SN706**	312	Different	1 9/16	1 1/8	Laminated Steel	3/8	1	1/2	0.55	18.20
SEJ518	312D	Different	1 9/16	1 1/8	Laminated Steel	3/8	1	1/2	0.55	18.20
SEJ519*	312TRI	Alike	1 9/16	1 1/8	Laminated Steel	3/8	1	1/2	0.55	40.00

\* Set of 3 locks

\*\* Thermoplastic covered shackle

## MASTER LOCK SHROUDED PADLOCK

- Patented "Octagonal" hardened "Boron-Carbide" shackle offers 50% greater strength than hardened steel while withstanding pulling and prying attacks
- The "Octagonal" shackle makes bolt cutter attacks virtually impossible
- Key retaining safeguard insures padlock is not left unlocked
- Covered keyway for maximum weather protection and rubber body bumper for scratch resistance
- Locks come with two keys

**Master Lock**

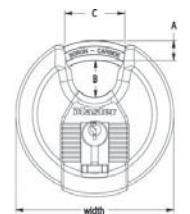

Model No.	Mfg. No.	Body Size		Body Material	Shackle Clearance			Shipping Weight (lbs.)	Price /Each
		Width"	Thickness"		A"	B"	C"		
SEJ511	M40BLCDHC	2 3/4 Round	1 3/8	Stainless Steel	13/16	5/8	3/8	0.85	24.70

## LAMINATED PADLOCKS

These locks are excellent in perimeter security, storefront gates, tool cribs, construction equipment, vending machines, truck doors and general security. Full range of sizes to best secure your applications.

### MASTER LOCK COMMERCIAL LAMINATED STEEL PADLOCKS (NON-REKEYABLE)

- Constructed of hardened, rustproofed steel laminated bodies that resist cutting, sawing and corrosion
- Hardened boron steel alloy shackles offer superior cut resistances while double locking mechanism provides extra pry and pulling resistance
- 4-pin cylinders helps prevent picking while providing 1,200 key changes
- Top and bottom bumpers provide greater scratch resistance
- Locks come with two keys
- For keyed alike options and master keying, please call us



#### KEYED DIFFERENT vs. KEYED ALIKE

Each keyed different lock has a unique key for higher security. Keyed alike locks have the same key for each lock. Keyed alike locks add an extra convenience where many locks are involved. Extra locks can be ordered later to fit the same key number.

Model No.	Mfg. No.	Key Type	Body Size		Body Material	Shackle Clearance			Shipping Weight (lbs.)	Price /Each
			Width"	Thickness"		A"	B"	C"		
SR890	5D	Different	2	1	Laminated Steel	3/8	1	15/16	0.80	21.60
SR867	5KA	Alike	2	1	Laminated Steel	3/8	1	15/16	0.80	22.90
SAL432	5LJ	Different	2	2 1/2	Laminated Steel	3/8	1	15/16	0.80	24.40
SA898	1	Different	1 3/4	7/8	Laminated Steel	5/16	15/16	3/4	0.60	17.00
SA899	1KA	Alike	1 3/4	7/8	Laminated Steel	5/16	15/16	3/4	0.60	18.30
SA900	1LJ	Different	1 3/4	7/8	Laminated Steel	5/16	2 1/2	3/4	0.65	19.70
SA901	1LJKA	Alike	1 3/4	7/8	Laminated Steel	5/16	2 1/2	3/4	0.65	21.00
SA894	3	Different	1 9/16	3/4	Laminated Steel	9/32	3/4	5/8	0.50	15.10
SA895	3KA	Alike	1 9/16	3/4	Laminated Steel	9/32	3/4	5/8	0.50	16.40
SA896	3LH	Different	1 9/16	3/4	Laminated Steel	9/32	2	5/8	0.58	19.30
SA897	3LHKA	Alike	1 9/16	3/4	Laminated Steel	9/32	2	5/8	0.58	20.60
SA890	7	Different	1 1/8	1/2	Laminated Steel	3/16	9/16	1/2	0.20	12.00
SA891	7KA	Alike	1 1/8	1/2	Laminated Steel	3/16	9/16	1/2	0.20	13.30
SA892	7LJ	Different	1 1/8	1/2	Laminated Steel	3/16	2 1/2	1/2	0.25	14.70
SA893	7LJKA	Alike	1 1/8	1/2	Laminated Steel	3/16	2 1/2	1/2	0.25	16.00

### MASTER LOCK ECONOMY LAMINATED STEEL WAVED PADLOCKS (NON-REKEYABLE)

- Warded locking mechanism minimizes jamming from dirt and grime
- Steel laminated body for superior strength, rustproofed for extended wear
- Steel alloy shackle provides strong cut resistance
- Model SEJ520 features a removeable adjustable shackle from shackle heights 2 3/4" to 5 3/8"
- Model SEJ521 shackle can be shattered by a hammer in case of emergencies, ideal for emergency accesses sprinkler shut-off valves and fire hose cabinets
- Locks come with two keys



Model No.	Mfg. No.	Key Type	Body Size		Body Material	Shackle Clearance			Shipping Weight (lbs.)	Price /Each
			Width"	Thickness"		A"	B"	C"		
SEJ520	517D	Different	1 3/4	7/8	Laminated Steel	9/32	2 3/4 to 5 3/8	13/16	0.75	11.80
SA888	500	Different	1 3/4	7/8	Laminated Steel	9/32	5/8	13/16	0.45	7.07
SA889	500KA	Alike	1 3/4	7/8	Laminated Steel	9/32	5/8	13/16	0.45	8.34
SEJ521	500KABRK	Alike	1 3/4	7/8	Laminated Steel	9/32	5/8	13/16	0.45	9.78
SA886	22	Different	1 1/2	3/4	Laminated Steel	1/4	5/8	9/16	0.50	5.76
SA887	22KA	Alike	1 1/2	3/4	Laminated Steel	1/4	5/8	9/16	0.50	7.05





## COMBINATION PADLOCKS

Master Lock has reinvented the combination padlock with our new Blockguard™ technology. This patent-pending "Anti-Shim" technology deters shimming a padlock - shimming is a method of violating a lock by inserting a specially designed tool into its latch mechanism. Blockguard™ has unique flat latch technology that blocks typical shimming tools from opening the locks and thus deterring break-ins.

- These combination padlocks feature the new Blockguard™ anti-shim technology
- Double-reinforced stainless steel case with cold-rolled steel construction shields locking mechanism from physical attack
- Hardened steel shackles resists cutting and prying
- 40 number, 3-number dialing provides thousands of possible combinations available
- Dial automatically locks under shackle tension to prevent "feeling out" the combination and automatically scrambles when closed to prevent accidental opening
- Fits lockers with a padlock eye of at least 5/16" (8 mm) in diameter



**Master Lock**

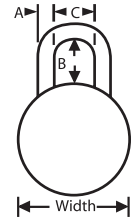

### MASTER LOCK SUPERVISORY COMBINATION PADLOCKS

- The model **SAX608** combination padlock allows a control key to be used by a supervisor to access all combination padlocks in their system - great for storage lockers
- **SAX609** control key sold separately, please call your branch for charting these locker systems

Model No.	Mfg. No.	Body Size		Body Material	Shackle Clearance			Shipping Weight (lbs.)	Price /Each
		Width"	Thickness"		A"	B"	C"		
SAX608	1525	1 7/8 Dia.	3/4	Stainless Steel	9/32	3/4	13/16	0.55	13.30
SAX609	K1525	Control Key		Brass	-	-	-	0.02	5.52

## MASTERLOCK COMBINATION PADLOCKS

- World's best selling combination lock
- Hardened steel shackle for extra cut resistance
- Combination security for keyless convenience
- Double-armored stainless steel body
- 3-digit dialing and 1500 combinations for maximum security
- Model **SR914** are school standard's in combination padlocks

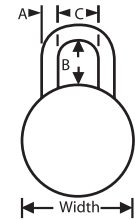

Model No.	Mfg. No.	Body Size		Body Material	Shackle Clearance			Shipping Weight (lbs.)	Price /Each
		Width"	Thickness"		A"	B"	C"		
SR914	1500	1 7/8 Dia.	3/4	Stainless Steel	9/32	3/4	13/16	0.50	8.18
SAL506	1500LH	1 7/8 Dia.	3/4	Stainless Steel	9/32	2	13/16	0.50	12.40

## MASTER LOCK HIGH SECURITY HASPS

- Ideal for vans, trucks, gates and vending machines
- Hardened steel hasp withstands forcible attacks
- Defeats attempts to pry and cut
- Designed to be used with **SAO688** (hidden shackle lock) for maximum security

SAO687

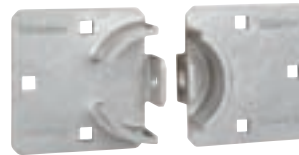

Model No.	Mfg. No.	Description	Hasp Length		Max Shackle Dia.		Shipping Weight (lbs.)	Price /Each
			Inches	mm	Inches	mm		
SAO687	770	9" x 4 1/2"	9	228	Accepts only puck locks		3.00	39.20
SAO688	6270	Lock	-	-	-	-	-	62.60

**Master Lock**

## MASTER LOCK HEAVY-DUTY SECURITY HASPS

- Zinc-plated hardened steel for added strength and weatherability
- Hardened steel staple resists cutting, sawing and hammering
- Hasp body conceals mounting hardware
- Mounting hardware included for easy installation
- Combine model **SEJ522** with **SAO688** (hidden shackle lock) for maximum security

SEJ522



Model No.	Mfg. No.	Description	Hasp Length		Max Shackle Dia.		Shipping Weight (lbs.)	Price /Each
			Inches	mm	Inches	mm		
SEJ522	730	7 1/4" Straight Bar	7 1/4	180	7/16	11	1.25	16.10
SAO688	6270	Lock	-	-	-	-	-	62.60

**Master Lock**

## MASTER LOCK HINGED SECURITY HASPS

- Secure hard-to-lock property, ideal for corners and angles
- Hardened steel body for added strength
- Hardened boron alloy staples resist cutting and sawing
- Single and double hinge styles with hidden hinge pins



SEJ523



SEJ524

Model No.	Mfg. No.	Description	Hasp Length		Max Shackle Dia.		Shipping Weight (lbs.)	Price /Each
			Inches	mm	Inches	mm		
SEJ523	722DPF	Double Hinge	7 3/4	197	7/16	11	0.94	17.40
SEJ524	720DPF	Single Hinge	6 1/4	159	7/16	11	0.80	15.40

**Master Lock**

## MASTER LOCK GENERAL SECURITY HASPS

- Hardened wrought ribbed steel and rolled edge design for added strength
- Hardened steel staples resist cutting and sawing
- Hardened steel locking eyes for strong cut resistance
- Tamper proof hinges help resist prying



Model No.	Mfg. No.	Description	Hasp Length		Max Shackle Dia.		Shipping Weight (lbs.)	Price /Each
			Inches	mm	Inches	mm		
SEJ525	706D	Hard Wrought Steel Body	6	152	9/16	14	0.60	15.50
SEJ526	704DPF	Hard Wrought Steel Body	4 1/2	114	1/2	13	0.40	8.16
SAG267	703D	Hard Wrought Steel Body	3 1/2	89	11/32	9	0.30	6.58
SEJ527	702D	Hard Wrought Steel Body	2 1/2	64	9/32	7	0.20	5.56



## AMERICAN LOCK® HIGH SECURITY GATE HASPS

- Patent-pending gate hasp provides maximum security, for double-drive industrial gates with 1 5/8" or 2" frames
- Shackle housing protects padlocks from cutting attacks
- Simple 4-bolt installation, with all mounting hardware included
- Adjustable slide fits gate openings from 3" to 6" wide
- Accepts padlocks with 7/16" diameter shackles and 1" vertical shackle clearance



Model No.	Mfg. No.	Description	Hasp Length		Max Shackle Dia.		Shipping Weight (lbs.)	Price /Each
			Inches	mm	Inches	mm		
SEJ528	A810	Padlock Eye, Right Angle	1 1/2	38	1/2	13	8.05	106.00

## ZENEX™ DIELECTRIC SAFETY PADLOCKS

- Designed exclusively for confined space, medical, military and electrical lockout/tagout
- Nylon shackle does not conduct electricity and is non-sparking
- All components are non-sparking and non-magnetic plastic, copper and brass
- Shackle withstands over 300-lb. pull force



### 406 SERIES

Model No.	Mfg. No.	Colour	Body Size		Body Material	Shackle Clearance			Shipping Weight (lbs.)	Price /Each
			Width"	Height"		Width"	Height"	Dia."		
SAR833	406RED	Red	1 1/2	1 3/4	Thermal Plastic	25/32	1 1/2	1/4	0.21	22.40
SAR834	406ORJ	Orange	1 1/2	1 3/4	Thermal Plastic	25/32	1 1/2	1/4	0.21	22.40
SAR835	406YLW	Yellow	1 1/2	1 3/4	Thermal Plastic	25/32	1 1/2	1/4	0.21	22.40
SAR836	406GRN	Green	1 1/2	1 3/4	Thermal Plastic	25/32	1 1/2	1/4	0.21	22.40
SAR837	406BLU	Blue	1 1/2	1 3/4	Thermal Plastic	25/32	1 1/2	1/4	0.21	22.40
SAR838	406BLK	Black	1 1/2	1 3/4	Thermal Plastic	25/32	1 1/2	1/4	0.21	22.40
SAR839	406PRP	Purple	1 1/2	1 3/4	Thermal Plastic	25/32	1 1/2	1/4	0.21	22.40
SAR840	406TEAL	Teal	1 1/2	1 3/4	Thermal Plastic	25/32	1 1/2	1/4	0.21	22.40

## S31 GLOBAL ZENEX™ THERMOPLASTIC SAFETY PADLOCKS

- Designed to fit smaller diameter lockout points for lockout/tagout applications (ie European OEM Equipment)
- 3/16" (4.76 mm) diameter shackle
- Marine grade 316 stainless steel shackle for superior corrosion resistance
- Special thermoplastic body offers superior performance against chemicals, moisture, heat, cold and UV
- Operates from -70°F to +350°F (-56°C to +176°C)
- Key retaining, cannot remove key unless the shackle is closed
- Shackle withstands over 300-lb. pull force



### S31 SERIES

Model No.	Mfg. No.	Colour	Body Size		Body Material	Shackle Clearance			Shipping Weight (lbs.)	Price /Each
			Width"	Height"		Width"	Height"	Dia."		
SED617	S31BLK	Black	1 3/8	1 7/8"	Thermal Plastic	5/8	1 1/2	3/16	0.23	21.60
SED618	S31BLU	Blue	1 3/8	1 7/8"	Thermal Plastic	5/8	1 1/2	3/16	0.23	21.60
SED619	S31GRN	Green	1 3/8	1 7/8"	Thermal Plastic	5/8	1 1/2	3/16	0.23	21.60
SED620	S31ORJ	Orange	1 3/8	1 7/8"	Thermal Plastic	5/8	1 1/2	3/16	0.23	21.60
SED621	S31RED	Red	1 3/8	1 7/8"	Thermal Plastic	5/8	1 1/2	3/16	0.23	21.60
SEJ529	S31YLW	Yellow	1 3/8	1 7/8"	Thermal Plastic	5/8	1 1/2	3/16	0.23	21.60

# LOCKS & LOCKOUT DEVICES



## ZENEX™ THERMOPLASTIC SAFETY PADLOCKS

- Designed exclusively for lockout/tagout
- Durable, lightweight, non-conductive body is easy to carry
- Special thermoplastic body offers superior performance against chemicals, moisture, temperature and UV
- Reserved-for-safety cylinder provides over 40,000 unique key changes available
- Key retaining - ensures that padlocks are not left unlocked, cannot remove key until shackle is closed
- Includes write-on "Danger" and "Property of" labels in English, French and Spanish
- Locks comes with one key: Compliance with OSHA "one employee, one lock, one key" directive
- Optional shackle heights of 1-1/2" or 3" are available upon request
- For extra keys or master keying, please call us
- Body size:
  - 410 Series:** 1-1/2" W x 1-3/4" H
  - 411 Series:** 1-1/2" W x 3" H
- Body material: Thermal plastic
- Shackle clearance: 25/32" W x 1-1/2" H x 1/4" Dia.

**Master Lock**



SAL142      SAL144      SAL134      SAL135      SAL137

### 410 SERIES - KEYED DIFFERENT

Model No.	Mfg. No.	Colour	Price /Each
SAL134	410BLK	Black	21.60
SAL135	410BLU	Blue	21.60
SAL136	410GRN	Green	21.60
SAL137	410ORJ	Orange	21.60
SAL138	410RED	Red	21.60
SAL139	410YLW	Yellow	21.60

### 411 SERIES - KEYED DIFFERENT

Model No.	Mfg. No.	Colour	Price /Each
SAL140	411BLK	Black	23.70
SAL141	411BLU	Blue	23.70
SAL142	411GRN	Green	23.70
SAL143	411ORJ	Orange	23.70
SAL144	411RED	Red	23.70
SAL145	411YLW	Yellow	23.70

### 410 SERIES - KEYED ALIKE

Model No.	Mfg. No.	Colour	Price /Each
<b>SETS OF 3</b>			
SDM765	410KAS3RED	Red	68.40
SDM767	410KAS3YLW	Yellow	68.40
SDM761	410KAS3BLU	Blue	68.40
<b>SETS OF 6</b>			
SDM773	410KAS6RED	Red	137.00
SDM775	410KAS6YLW	Yellow	137.00
SDM769	410KAS6BLU	Blue	137.00
<b>SETS OF 12</b>			
SDM781	410KAS12RED	Red	274.00
SDM783	410KAS12YLW	Yellow	274.00
SDM777	410KAS12BLU	Blue	274.00

Available in sets of 18 and 24. Also available in other colours

### 411 SERIES - KEYED ALIKE

Model No.	Mfg. No.	Colour	Price /Each
<b>SETS OF 3</b>			
SDM805	411KAS3RED	Red	74.90
SDM807	411KAS3YLW	Yellow	74.90
SDM801	411KAS3BLU	Blue	74.90
<b>SETS OF 6</b>			
SDM813	411KAS6RED	Red	150.00
SDM815	411KAS6YLW	Yellow	150.00
SDM809	411KAS6BLU	Blue	150.00
<b>SETS OF 12</b>			
SDM821	411KAS12RED	Red	300.00
SDM823	411KAS12YLW	Yellow	300.00
SDM817	411KAS12BLU	Blue	300.00

Available in sets of 18 and 24. Also available in other colours

## PADLOCK IDENTIFICATION LABELS

- Optimize your facility's lockout practices with photo ID labels or laminated safety padlock labels for your employee's safety padlocks
- **Photo ID labels:** Self adhesive labels to be applied to your safety padlocks
- Customer can print their own photo and size it to fit photo ID label
- **Laminated identification labels:** Self adhesive labels with clear overlaminates to be applied to your safety padlocks



**Master Lock**

Model No.	Mfg. No.	Description	Dimensions			Price /Each
			W"	x	T"	
SEJ530	5142	Photo ID Labels for 410, 531, 533 Padlocks (6 labels/pkg.)	1	x	1	7.43
SEJ531	0411-5705	Photo ID Labels for 411 Series Padlocks (6 labels/pkg.)	1	x	3-5/8	8.07
SEJ532	6835-5700	Photo ID Labels for Aluminum Padlocks (6 labels/pkg.)	1-1/4	x	2-3/4	6.63
SEJ533	461	Padlock Safety Labels w/clear overlaminates (50 labels/pkg.)	5	x	1	65.70

## LASER ENGRAVING

- A permanent and durable method to customize your safety padlocks
- Available on Master Lock/American Lock aluminum and Zenex™ padlocks
- Laser engrave information on the padlock face, side and back
- A name, company logo or key number, you select the important information to engrave on the padlock
- For further laser engraving customization of your padlocks, please call us!



## AMERICAN LOCK® ALUMINUM SAFETY PADLOCKS

- Lightweight solid aluminum body for lockout/tagout
- Durable, anodized colour finish is suitable for lockout/tagout procedures in food and pharmaceutical manufacturing
- Uses FDA approved lubricants safe for use in food processing
- 1/4" diameter boron steel shackle with plated finish for corrosion resistance
- Over 10000 unique key changes available
- Removable 5-pin cylinder can be replaced or repined
- Safety colour recognition, plus high security
- Key retaining option available. Includes two keys per lock
- Optional shackle heights of 1", 1-1/2" or 3" are available upon request
- Your facility's padlocks can be key charted to ensure no key duplication on site....ask about this service
- For master keying, please call us
- Body size: 1-1/2" W x 1-3/4" H
- Body material: Aluminum
- Shackle clearance: 25/32" W x 1" H x 1/4" Dia.



### A1105 SERIES - KEYED DIFFERENT

Model No.	Mfg. No.	Colour	Price /Each
SA0712	A1105BLK	Black	19.90
SA0713	A1105BLU	Blue	19.90
SA0714	A1105GRN	Green	19.90
SA0715	A1105ORJ	Orange	19.90
SA0716	A1105RED	Red	19.90
SA0717	A1105YLW	Yellow	19.90
SA0718	A1105BRN	Brown	19.90
SA0719	A1105CLR	Clear	19.90
SA0720	A1105PRP	Purple	19.90

### A1105 SERIES - KEYED ALIKE

Model No.	Mfg. No.	Colour	Price /Each
<b>SETS OF 3</b>			
SDM877	A1105KAS3RED	Red	63.40
SDM878	A1105KAS3YLW	Yellow	63.40
SDM871	A1105KAS3BLU	Blue	63.40
<b>SETS OF 6</b>			
SDM886	A1105KAS6RED	Red	127.00
SDM887	A1105KAS6YLW	Yellow	127.00
SDM880	A1105KAS6BLU	Blue	127.00
<b>SETS OF 12</b>			
SDM895	A1105KAS12RED	Red	254.00
SDM896	A1105KAS12YLW	Yellow	254.00
SDM889	A1105KAS12BLU	Blue	254.00

Available in sets of 18 and 24. Also available in other colours

## MASTER LOCK® ALUMINUM SAFETY PADLOCKS

- Lightweight solid aluminum body
- Durable, baked on powder-coat colour finish stays bright in all UV conditions
- 1/4" diameter boron steel shackle with plated finish for corrosion resistance
- Over 10000 unique key changes available
- Key retaining option available. Includes two keys per lock
- Optional shackle heights of 1", 1 1/2" or 3" are available upon request
- Your facility's padlocks can be key charted to ensure no key duplication on site....ask about this service
- For master keying, please call us
- Body size: 1-1/2" W x 1-3/4" H
- Body material: Aluminum
- Shackle clearance: 25/32" W x 1" H x 1/4" Dia.



### 6835 SERIES - KEYED DIFFERENT

Model No.	Mfg. No.	Colour	Price /Each
SN709	6835RED	Red	19.90
SN710	6835BLU	Blue	19.90
SN711	6835GRN	Green	19.90
SN712	6835YLW	Yellow	19.90
SN713	6835ORJ	Orange	19.90
SN714	6835BLK	Black	19.90

### 6835 SERIES - KEYED ALIKE

Model No.	Mfg. No.	Colour	Price /Each
<b>SETS OF 3</b>			
SDM844	6835KAS3RED	Red	63.40
SDM845	6835KAS3YLW	Yellow	63.40
SDM841	6835KAS3BLU	Blue	63.40
<b>SETS OF 6</b>			
SDM850	6835KAS6RED	Red	127.00
SDM851	6835KAS6YLW	Yellow	127.00
SDM847	6835KAS6BLU	Blue	127.00
<b>SETS OF 12</b>			
SDM856	6835KAS12RED	Red	254.00
SDM857	6835KAS12YLW	Yellow	254.00
SDM853	6835KAS12BLU	Blue	254.00

Available in sets of 18 and 24. Also available in other colours

# LOCKS & LOCKOUT DEVICES



## MASTER LOCK® LAMINATED STEEL SAFETY LOCKOUT PADLOCKS



- Reinforced laminated steel body withstands physical abuse
- Key code stamped on key and on bottom of padlock for easy identification
- Uses FDA approved lubricants safe for use in food processing
- 9/32" diameter boron steel shackle with plated finish for corrosion resistance
- Over 1,400 unique key changes available
- Comes with two keys per padlock
- Optional shackle heights of 3/4", 1 1/2" or 2" are available upon request
- Your facility's padlocks can be key charted to ensure no key duplication on site....ask about this service
- For keyed alike options or master keying, please call us



### 3 SERIES

Model No.	Mfg. No.	Colour	Body Size		Body Material	Shackle Clearance			Shipping Weight (lbs.)	Price /Each
			Width"	Thickness"		A"	B"	C"		
SAL146	3BLU	Blue	1-9/16	1-1/2	Laminated Steel	9/32	3/4	5/8	0.40	15.60
SAL147	3RED	Red	1-9/16	1-1/2	Laminated Steel	9/32	3/4	5/8	0.40	15.60
SAL148	3YLW	Yellow	1-9/16	1-1/2	Laminated Steel	9/32	3/4	5/8	0.40	15.60
SAL149	3GRN	Green	1-9/16	1-1/2	Laminated Steel	9/32	3/4	5/8	0.40	15.60
SAL150	3BLK	Black	1-9/16	1-1/2	Laminated Steel	9/32	3/4	5/8	0.40	15.60
SAL151	3WHT	White	1-9/16	1-1/2	Laminated Steel	9/32	3/4	5/8	0.40	15.60
SAL152	3LHBLU	Blue	1-9/16	1-1/2	Laminated Steel	9/32	2	5/8	0.42	19.80
SAL153	3LHRED	Red	1-9/16	1-1/2	Laminated Steel	9/32	2	5/8	0.42	19.80
SAL154	3LHYLW	Yellow	1-9/16	1-1/2	Laminated Steel	9/32	2	5/8	0.42	19.80
SAL155	3LHGRN	Green	1-9/16	1-1/2	Laminated Steel	9/32	2	5/8	0.42	19.80
SAL156	3LHBLK	Black	1-9/16	1-1/2	Laminated Steel	9/32	2	5/8	0.42	19.80
SAL157	3LHWHT	White	1-9/16	1-1/2	Laminated Steel	9/32	2	5/8	0.42	19.80

## LATCH TIGHT™ LOCK BOXES

- Integrated storage organizes up to 12 keys or hundreds of bulk keys
- Can only release when no padlocks are fastened to the lock box
- Works with all safety padlock shackle sizes and lengths
- Traditional bulk key storage is also possible through the key slot in front of the lock box lid
- Has lockout points for 14 padlocks or hasps
- Unit can be mounted to a wall or carried with the comfortable form fitted handle
- Powder coated finish on heavy-duty steel box and stainless steel handle withstand harsh industrial environments



Model No.	Mfg. No.	Colour	Price /Each
SA0597	503RED	Red	108.00
SA0628	503YEL	Yellow	108.00

## LATCH TIGHT™ PORTABLE LOCK BOXES

- With new Latch Tight™ locking mechanism
- English, Spanish, French message on box
- Accepts 12 padlocks or lockout hasps
- Complements SA0597 and SA0628 wall mount lock box (call for more info)



Model No.	Mfg. No.	Colour	Price /Each
SAL519	498A	Red	108.00

## LOCKOUT TAGOUT CABINET

The Lok Box stands up to the toughest industrial work environments. Ready to use, it will provide employees with a focal point to pick up the required products when following their lockout /tagout procedures. The Lok Box is painted with a high-visibility industrial safety yellow acrylic polyester paint that is baked in for improved durability. Available in three different sizes - you choose the one best suited to your needs. Complete with padlocks, lockout hasps and tags or empty if you choose to assemble your own kit.

### W/COMPONENTS

Model No.	Mfg. No.	Size	Price /Each
SG951	65646	Small	238.51
SG952	65648	Medium	347.51
SG953	65650	Large	831.22

### W/O COMPONENTS

Model No.	Mfg. No.	Size	Price /Each
SG954	65647	Small	70.99
SG955	65649	Medium	86.81
SG956	65651	Large	151.91



### DIMENSIONS & COMPONENTS

Size	Dimensions				No. of Padlocks	No. of Lockout Hasps	No. of Lockout Tags	
	W"	x	D"	x				H"
Small	7	x	3	x	8	4	3	25
Medium	8	x	3	x	11	8	4	25
Large	12	x	3	x	16	20	9	75

## PADLOCK CADDIES

- Durable plastic construction
- Allows user to carry or store safety locks to address all lockout points
- Can be customized to the number of padlocks needed by user for lockout points (max 12 locks)
- Can be carried, mounted on belt or hung at lockout site
- Collated key holder ensures user's key is with the locks
- Dimensions: 7 1/4" W x 5 1/8" H x 19/32" Thick
- Ergonomic carry handle

Model No. SAR846  
Mfg. No. S125  
Price/Each \$14.20

**Master  
Lock.**



Note: Padlocks and key not included

## HEAVY-DUTY PADLOCK RACK STATIONS

- Locate padlocks near lockout point
- Heavy gauge steel with durable powder coat finish ensures long life in manufacturing environment
- Includes labels in English, French and Spanish



**Master  
Lock.**

Model No.	Mfg. No.	Description	Padlock Capacity	Price/Each
SAP985	S1506	6 1/4" x 1 1/2"	6 to 8	27.30
SAP986	S1518	17 1/2" x 1 1/2"	18 to 22	41.00

## TAG STATIONS

- Durable tag centre holds 18 tags
- Hanger clips hold padlocks and hasps
- Includes face labels in English, French and Spanish
- Dimensions: 9 3/4" x 5 3/4" x 1 1/2"

**Master  
Lock.**

Model No.	Mfg. No.	Description	Price/Each
SAP987	S1601	Tag Centre (unfilled)	20.50
SAP988	S1601A	Tag Centre, 12 English Tags	45.80
SAP989	S1601FRC	Tag Centre, 12 Bilingual Tags	45.80



SAP987

LOCKS AND HASPS NOT INCLUDED



SAP988

## COMPACT LOCKOUT STATIONS

- Ideal for locating machine specific lockout devices, tags and padlocks near lockout point
- 6 1/2" W x 2 7/8" D x 2 7/8" H bin holds circuit breaker lockouts, valve lockouts, plug lockouts, tags and much more
- Hanger clips hold padlocks and hasps
- Dimensions: 9 3/4" x 7 7/8" x 2 7/8"
- Includes face labels in English, French and Spanish

**Master  
Lock.**



SAP993



SAP990

Model No.	Mfg. No.	Description	Contains	Price/Each
SAP990	S1700	Compact Lockout Station	Unfilled	42.70
SAP991	S1705P410	Compact Lockout Station	One hasp, two tags, 1 Zenex™ Lock	79.70
SAP992	S1720E410	Circuit Breaker Lockout Station	Two SA0595 breaker lockouts, four tags and two Zenex™ Locks	143.00
SAP993	S1745E410	Plug Lockout Station	One plug lockout, one tag and one Zenex™ Lock	89.50



# LOCKS & LOCKOUT DEVICES



**Master  
Lock**

## LOCKOUT STATIONS

### Virtually Indestructible, the Strongest Stations Available!

- Integrated, one-piece molded construction eliminates loose parts
- Resilient polycarbonate material provides twice the heat resistance and quadruples the impact strength of typical stations
- Reinforced snap-lock clips provide easy padlock and hasp storage and removal
- Exclusive translucent lockable cover protects contents and prevents loss of valuable safety lockout padlocks
- Innovative hinge holds cover open for easy product selection
- Available with your choice of safety lock design with highly visible red locks keyed different of Zenex™, aluminum or laminated steel in 4, 10 or 20 lock format
- Zenex™ locks available with up to 100,000 key changes available to fit even the largest lockout systems
- Compliant with OSHA "One employee, One lock, One key" directive
- Lockout stations are bilingual with English/ French labels and lockout tags

### 4-LOCK STATIONS INCLUDE:

- 4 Master Lock® Safety Series™ padlocks
- 2 Safety Series™ hasps for lockouts by up to six workers
- 12 Safety Series™ heavy-duty bilingual "Do Not Operate" lockout I.D. tags with brass grommets
- Dimensions: 12.25" x 16" x 1.75"

Model No	Mfg. No.	Description	Price /Each
SA0598	1482BFRC	Base only (unfilled)	119.00
SA0601	1482BP3FRC	Station with Laminated Padlocks	217.00
SA0602	1482BP410FRC	Station with Zenex™ Padlocks	239.00
SA0603	1482BP1106FRC	Station with American Lock® Aluminum Padlocks	231.00

### 10-LOCK STATIONS INCLUDE:

- 10 Master Lock® Safety Series™ padlocks
- 2 Safety Series™ hasps for lockouts by up to six workers
- 24 Safety Series™ heavy-duty bilingual "Do Not Operate" lockout I.D. tags with brass grommets
- Dimensions: 15.5" x 22" x 1.75"

Model No	Mfg. No.	Description	Price /Each
SA0599	1483BFRC	Base only (unfilled)	174.00
SA0604	1483BP3FRC	Station with Laminated Padlocks	402.00
SA0605	1483BP410FRC	Station with Zenex™ Padlocks	459.00
SA0606	1483BP1106FRC	Station with American Lock® Aluminum Padlocks	440.00

### 20-LOCK STATIONS INCLUDE:

- 20 Master Lock® Safety Series™ padlocks
- 4 Safety Series™ hasps for lockouts by up to six workers
- 48 Safety Series™ heavy-duty bilingual "Do Not Operate" lockout I.D. tags with brass grommets
- Dimensions: 22" x 22" x 1.75"

Model No	Mfg. No.	Description	Price /Each
SA0600	1484BFRC	Base only (unfilled)	229.00
SA0607	1484BP3FRC	Station with Laminated Padlocks	747.00
SA0608	1484BP410FRC	Station with Zenex™ Padlocks	862.00
SA0609	1484BP1106FRC	Station with American Lock® Aluminum Padlocks	825.00

SA0601



SA0605



SA0609



## DELUXE LOCKOUT STATIONS

- Durable construction ensures long life in your facility
- Covered compartments protects devices and keep dust and grime out
- Upper and lower section are lockable ensuring lockout devices are there when needed
- Add a combination lock for simple access control
- 16 hanger clips holds two padlocks or hasps each
- Moveable dividers in top and bottom trays help organize devices
- Holes provided along the bottom for optional peg hook hangers to hang bulky devices
- Lower half has two tip-out drawers, each measuring 10" W x 6 7/8" H x 1/4" D
- Dividers included to create 2, 3, 4, 5 or 6 compartments
- Each compartment in lower section holds 25 tags, 150 tags total
- Lockout stations are bilingual with English/French labels and lockout tags
- Dimension: 23.5" W x 4.5" D x 27" H
- Station includes: 6 padlocks, 2 hasps, 1 snap-on hasp, 1 adjustable cable lockout, 4 gate valve lockout, 2 ball valve lockout, 1 compact plug prong lockout, 1 plug cover, 6 circuit breaker lockout, 2 wall switch covers, 2 packs of tags (12/pack)

**Master  
Lock.**

Model No.	Mfg. No.	Description	Price /Each
SAS415	S1900FRC	Base only (unfilled)	313.00
SAS412	S1900VE410FRC	Station with Zenex™ Padlocks	971.00
SAS413	S1900VE1106FRC	Station with American Lock® Aluminum Padlocks	967.00
SAS414	S1900VE3FRC	Station with Steel Padlocks	930.00



SAS412

## LOCKOUT STATIONS

- Durable construction for years of use in corrosive environments
- Eight hanger clips holds two padlocks or lockout hasps each
- Top and bottom compartments each have five moveable dividers
- Holes provided along with bottom for optional peg hook hangers to hang bulky devices
- Lockable - use a combination padlock to limit access to authorized employees
- Covered compartments protect devices and keep dust and grime out
- Dimensions: 23.5" W x 4.5" D x 15.5" H
- Electrical focus station includes: 6 padlocks, 1 hasp, 1 snap-on hasp, 1 compact plug prong lockout, 1 plug cover, 6 circuit breaker lockout, 2 wall switch covers, 2 packs of tags (12/pack)
- Valve lockout focus station includes: 6 padlocks, 1 hasp, 1 snap-on hasp, 3 gate valve lockout, 2 ball valve lockout, 2 tags (12/pack)

**Master  
Lock.**

Model No.	Mfg. No.	Description	Price /Each
<b>ELECTRICAL FOCUS STATIONS</b>			
SAS416	S1850FRC	Base only (unfilled)	199.00
SAS417	S1850E410FRC	Station with Zenex™ Padlocks	547.00
SAS418	S1850E1106FRC	Station with American Lock® Aluminum Padlocks	567.00
SAS419	S1850E3FRC	Station with Steel Padlocks	531.00
<b>VALVE LOCKOUT FOCUS STATIONS</b>			
SAS416	S1850FRC	Base only (unfilled)	199.00
SAS420	S1850V410FRC	Station with Zenex™ Padlocks	608.00
SAS421	S1850V1106FRC	Station with Aluminum American Lock® Padlocks	604.00
SAS422	S1850V3FRC	Station with Steel Padlocks	567.00



SAS417



SAS420

## DELUXE TAG CENTRES

- Two tip-out bins each have three compartments for tags
- Each compartment holds 25 tags, capacity 150 tags
- Compartments can also hold safety eyewear and ear protection
- Each tip-out drawer measures 10" W x 6 7/8" H x 3 1/4" D
- Eight hanger clips can hold safety padlocks or hasps
- Lockable - use a combination padlock to limit access to authorized employees
- Dimension: 22" W x 4 1/8" D x 11" h

Model No. SAS423  
Mfg. No. S1800  
Price/Each \$114.00

**Master  
Lock.**

TAGS NOT INCLUDED



SAS423

# LOCKS & LOCKOUT DEVICES

## MINI LOCKOUT STATIONS

- Four solid Master Lock® padlocks with blue bumpers
- 25 durable lockout tags, 3" x 5 3/4", printed with "Do Not Operate"
- Tags are made of 20 mil styrene
- Three metal lockout hasps
- Lockouts are 4 3/8" long, have a 1" hasp and a perforated tab that is painted red and can accommodate up to six locks
- Lockout station is made of double-walled polystyrene, comes with pre-drilled mounting holes and metal hooks
- Size of station: 11" x 14"

**Honeywell**

English Model No.	Mfg. No.	French Model No.	Mfg. No.	Description	Price /Each
S1957	LSE104	SE323	LSF104	Empty Station	50.50
S1958	LSE104F	SE324	LSF104F	Station w/Accessories	156.00



S1958



S1960

## SINGLE LOCKOUT STATIONS

- 10 solid Master Lock™ padlocks with blue trim
- 50 durable lockout tags, 3" x 5 3/4", printed with "Do Not Operate"
- Tags are made of 20 mil styrene
- Three metal lockout hasps
- Lockouts are 4 3/8" long, have a 1" hasp and a perforated tab that is painted red and can accommodate up to six locks
- Lockout station is made of double-walled polystyrene, comes with pre-drilled mounting holes and metal hooks
- Size of station: 14" x 21"

**Honeywell**

English Model No.	Mfg. No.	French Model No.	Mfg. No.	Description	Price /Each
S1959	LSE105	SE325	LSF105	Empty Station	77.00
S1960	LSE105F	SE326	LSF105F	Station w/Accessories	406.00

## DEPARTMENT LOCKOUT STATIONS

- 20 solid Master Lock™ padlocks with blue trim
- 100 durable lockout tags, 3" x 5 3/4", printed with "Do Not Operate"
- Tags are made of 20 mil styrene
- Six metal lockout hasps
- Lockouts are 4 3/8" long, have a 1" hasp and a perforated tab that is painted red and can accommodate up to six locks
- Lockout station is made of double-walled polystyrene, comes with pre-drilled mounting holes and metal hooks
- Size of station: 21" x 29"

**Honeywell**

English Model No.	Mfg. No.	French Model No.	Mfg. No.	Description	Price /Each
S1961	LSE106	SE327	LSF106	Empty Station	115.00
S1962	LSE106F	SE328	LSF106F	Station w/Accessories	878.00



S1962



## LOCKOUT TOOL BOXES WITH COMPONENTS

A crucial part of any lockout/tagout program is to prevent worker injury by cutting the power on a piece of equipment that is being serviced. The Lockout Tool Box, 17" W x 5" D x 4 1/2" H, has what you need to lock and mark your equipment preventing its use until repairs have been completed.

### KIT CONTAINS:

- |                                   |                                       |
|-----------------------------------|---------------------------------------|
| 1 Plastic lockout tool box w/tray | 5 Lockout tags                        |
| 1 1" to 2.5" gate valve lockout   | 1 Universal multi-pole lockout        |
| 1 Small ball valve lockout        | 1 277 V "No Hole" breaker lockout     |
| 1 3/4" blue padlock               | 1 480/600 V "No Hole" breaker lockout |
| 1 2" blue padlock                 | 1 Labeled lockout hasp                |
| 1 Wall switch lockout             |                                       |
| 1 Labeled lockout hasp            |                                       |

**Model No. SG946**  
**Mfg. No. 65289**  
**Price/Each \$220.00**



## COMBINATION LOCKOUT STARTER KITS

Protect your employees and comply with OSHA standards with the Combination Lockout Starter Kit. Whether you want to secure breakers wall switches, plugs or gate and ball valves, this kit has the lockout devices to get you started.

### KIT CONTAINS:

- |   |                                       |
|---|---------------------------------------|
| 6 Single pole breaker lockouts          | 2 Small ball valve lockouts           |
| 6 227 V "No Hole" breaker lockouts      | 2 Large ball valve lockouts           |
| 6 Universal multi-pole breaker lockouts | 5 Red labeled lockout hasps           |
| 6 Wall switch lockouts                  | 6 3/4" blue padlocks                  |
| 1 Small plug lockout                    | 6 2" blue padlocks                    |
| 1 Large plug lockout                    | 25 Lockout tags                       |
| 2 1" to 2.5" gate valve lockouts        | 2 Yellow canvas locking carrying bags |
| 2 2.5" to 5" gate valve lockouts        |                                       |

**Model No. SG947**  
**Mfg. No. 65779**  
**Price/Each \$812.00**



## ELECTRICAL LOCKOUT TOOLBOXES

- All the basics for locking out breakers, electrical plugs, wall switches and fuses

### KIT CONTAINS:

- 2 Mini cable lockouts
- 2 120 V snap-on breaker lockouts
- 2 120 V/277 V clamp-on breaker lockouts w/cleats
- 2 480 V/400 V Clamp-On Breaker Lockouts w/cleats
- 2 Universal multi-pole breaker lockouts
- 1 Oversized breaker lockout
- 1 3-in-1 plug lockout
- 1 Wall switch lockout
- 1 Small fuse blockout
- 1 Large fuse blockout
- 1 Extra-large lockout toolbox



Model No.	Mfg. No.	Description	Price /Each
SEC369	99310	Electrical Lockout Toolbox Kit	272.00
SEC370	99312	Kit w/2 Safety Padlocks & 2 Tags	313.00

## PERSONAL BREAKER LOCKOUT POUCHES

- Pouch contains one each of the most popular circuit breaker lockouts
- Covers 120 V/277 V and 460 V/600 V breakers in single- and multi-pole configurations

### KIT CONTAINS:

- 1 120 V/277 V clamp-on breaker lockout w/cleat
- 1 480 V/600 V clamp-on breaker lockout w/cleat
- 1 Universal multipole breaker lockout
- 2 1" group lockout hasps
- 2 Heavy-duty lockout tags w/nylon cable ties
- 1 Lockout belt pouch



SEC367



SEC368

Model No.	Mfg. No.	Description	Price /Each
SEC367	105966	Personal Breaker Lockout Pouch Kit	93.70
SEC368	105967	Kit w/2 Keyed-Alike Safety Padlocks	150.00

# LOCKS & LOCKOUT DEVICES

## PERSONAL LOCKOUT POUCHES

- Easy to carry pouch holds lockout essentials
- Holds one worker's personal padlocks, tags and circuit breaker devices

### KIT CONTAINS:

- 1 Padlock **SAL138** for **SAL515** and **SED603** and **SAL147** for **SAL516**
- 1 Pouch **SAL538**
- 1 Breaker switch padlock **SAL525**
- 1 Hasp **SA875**
- 2 Circuit breaker lockouts **SAO595**
- 1 Circuit breaker lockouts **SAO594**
- 12 "DO NOT OPERATE" tags - see **SBD042** for English and **SEC862** for French replacement tags (25/pkg.)



**Master Lock**

Model No.	Mfg. No.	Description	Price/Each
<b>SAL515</b>	1456E410	Large Pouch w/Zenex™ Padlock	151.00
<b>SAL516</b>	1456E3BLU	Large Pouch w/Steel Padlock	146.00
<b>SAL538</b>	1456	Large Pouch Only	43.30
<b>SED603</b>	S1010E410	Compact pouch w/Zenex™ padlock	135.00
<b>SED602</b>	S1010	Compact pouch only	25.10



## ELECTRICAL LOCKOUT KITS

### (KEYED ALIKE PADLOCKS)

- Safety lockout carrying case keeps important lockout devices and padlocks together
- Personal kits are for the individual worker; padlocks supplied are keyed-alike for added worker convenience
- Kits include high-use components, satisfying most applications

### KIT CONTAINS:

- 3 Zenex™ Padlocks
- 1 Portable safety carrying case **SEC446**
- 1 Breaker switch padlock **SAL525**
- 1 Hasp **SA875**
- 1 Snap-on hasp **SAL541**
- 3 Circuit breaker lockouts **SAO595**
- 2 Circuit breaker lockouts **SAO594**
- 1 Wall switch cover - see **SAO708** for replacement cover
- 12 "DO NOT OPERATE" tags - see **SBD042** for English and **SEC862** for French replacement tags (25/pkg.)



**Master Lock**

Model No.	Mfg. No.	Description	Price/Each
<b>SAL536</b>	1457E410KA	w/Zenex™ Padlocks	255.00
<b>SAL537</b>	1457E3KA	w/Steel Padlocks	235.00
<b>SEC446</b>	S1017	Carrying Case Only	39.10



## ELECTRICAL & VALVE LOCKOUT KITS

- Modular lockout/tagout organizers
- Lightweight safety lockout carrying case with modular, translucent storage compartments for improved organization and fast component selection
- Separate compartments for effective grouping of (1) padlocks and hasps, (2) valve lockout and (3) electrical lockout components
- Kits include high-use components, satisfying most applications
- Group kits are for multiple workers; padlocks supplied are keyed-different, so that no unwanted key interchange occurs
- Include permanent write-on labels (English, French and Spanish) that allow instant on-site customization for each worker



### KIT CONTAINS:

- 6 Padlocks **SAL138** for **SAL517**
- 1 Portable safety organizer **SAL543**
- 2 Breaker switch padlocks **SAL525**
- 1 Hasp **SA875**
- 1 Snap-on hasp **SAL541**
- 1 Adjustable cable lockout **SED597**
- 1 Plug cover lockout **SAL520**
- 1 Plug cover lockout **SAL521**
- 1 **SAL526, SAL527** and **SAL528** gate valve cover
- 2 Ball valve covers - see **SAO596** for replacement covers
- 6 Circuit breaker lockouts **SAO595**
- 3 Circuit breaker lockouts **SAO594**
- 2 Wall switch covers - see **SAO708** for replacement cover
- 24 "DO NOT OPERATE" tags - see **SBD042** for English and **SEC862** for French replacement tags (25/pkg.)

Model No.	Mfg. No.	Description	Price/Each
<b>SAL517</b>	1458VE410	w/Zenex™ Padlocks	<b>717.00</b>
<b>SAL543</b>	1458	Portable Safety Organizer Only	<b>75.40</b>

## ADJUSTABLE CABLE LOCKOUTS

- Infinitely adjustable for a secure fit every time
- Integrated, single-piece safety hasp and cable for ease-of-use
- Ideal for both multiple circuit breaker panel and side-by-side gate valve lockouts
- Tough, lightweight, Zenex™ thermoplastic body withstands chemicals; performs effectively in extreme conditions
- Tough flexible multistranded steel cable is insulated with a clear plastic coating
- Up to four workers can apply their personal safety locks
- Red lockout colour identifies the safety lockout application
- Complete with high-visibility permanent safety labels (English, French and Spanish) that can be written on to identify the responsible person and then erased for the next job
- Custom cable lengths available

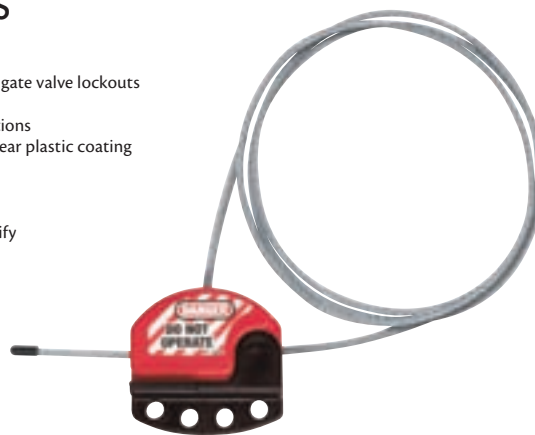

Model No.	Mfg. No.	Description	Price /Each
<b>SED596</b>	S806CBL3	Cable lockout w/3' cable	<b>36.60</b>
<b>SED597</b>	S806	Cable lockout w/6' cable	<b>36.60</b>
<b>SED598</b>	S806CBL15	Cable lockout w/15' cable	<b>46.60</b>



# LOCKS & LOCKOUT DEVICES



## LABELLED SNAP-ON HASPS

- Combines multiple-person lockout and tagout identification
- Features an easy-to-apply "snap-on" advantage with its spring-loaded locking arm
- Fits more lockout points than alternative rivet-hinge labeled lockout hasps
- Anodized aluminum and stainless steel construction for combined corrosion resistance and strength
- Complete with high-visibility permanent safety labels (English, French and Spanish) that can be written on to identify the responsible person and then erased for the next job



**Master Lock**

Model No.	Mfg. No.	Colour	Price /Each
SALS41	427	Red	18.40
SAP994	427BLK	Black	18.40
SAP995	427BLU	Blue	18.40
SAP998	427GRN	Green	18.40
SAQ002	427YLW	Yellow	18.40
SAQ003	427AST	Assorted 6/pkg.*	111.00

\*Includes red, black, blue, green, yellow and silver

## LOCKOUT HASPS

Multiple lockouts provide a means of locking control devices for machinery or electrical power sources, while maintenance or repairs are being carried out. Designed for use on fuse and switchboxes, air, steam, or acid valves. Accommodates padlocks shackles up to 3/8" diameter and hasp is 1" diameter.

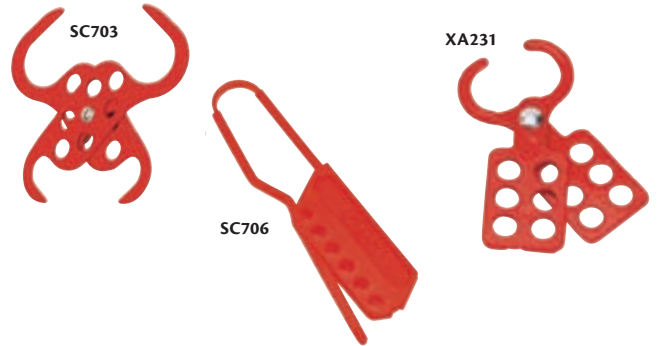

Model No.	Mfg No.	Description	Dimensions"	Price /Each
SC703	RSE66	Dual Scissor, Steel Polyester-Coated	5-1/4	6.66
XA231	RAE60	Single Scissor, Aluminum Polyester-Coated	4-3/8 x 3/8	4.76
SC706	MS01	Nylon Dielectric Single Vertical Line Lock	1-5/8 x 6-7/8	5.00
SA0703	429	Dual Jaw Aluminum	2 x 5-7/8	12.20
SA0704	418	4-Lock Heavy-Duty Steel	2-3/8 x 3-1/4	9.52
SA0705	419	8-Lock Heavy-Duty Steel	2-3/8 x 6-5/8	11.40

## SAFETY LOCKOUT HASPS

- Attach hasp to energy disconnect switch
- Control cannot be turned on until last worker's padlock is removed from hasp
- Multiple styles available

**Master Lock**



Model No.	Mfg. No.	Description	Dimensions W" x L"	Inside Jaw Clearance"	Jaw Dia.	Padlock Capacity	Price /Each
SEA314	416	Spark Resistant Aluminum	1-1/2 x 4-3/8	1	1/4"	6	8.87
SEA315	417	Spark Resistant Aluminum	2 x 4-7/8	1-1/2	1/4"	6	10.30
SA0704	418	Heavy-Duty Steel	2-3/8 x 3-1/4	1	1/4"	4	9.52
SA0705	419	Heavy-Duty Steel	2-3/8 x 3-1/4	3	1/4"	8	11.40
SAN507	422	Economy Yellow Safety Hasp w/Locking Tabs	1-3/4 x 4-1/2	1	1/4"	6	7.05
SAN508	424	Economy Yellow Safety Hasp w/Locking Tabs	2-3/8 x 5	1-1/2	1/4"	6	8.18
SAR075	428	Nylon Non-Conductive Hasp	1-5/8 x 6-7/8	1 x 2-1/2	3/16"	6	6.85
SA0703	429	Dual Jaw Aluminum Hasp	2 x 5-7/8	1 x 2-1/2	1/4"	8	12.20
SED601	S430	Steel Hasp w/Red Plastic Handle	2-1/4 x 3"	1	4 mm	2	8.01



## ROTATING ELECTRICAL PLUG LOCKOUTS

- Outward/inward rotation allows for easier installation and storage
- Unique outward rotation allows for easier installation in confined space applications
- Surrounds the electrical plug; protects against accidental reconnection
- Each size rotates into itself to fit effectively into safety tool boxes
- Tough, lightweight, dielectric Zenex™ thermoplastic bodies withstand chemicals; perform effectively in extreme conditions (temperature range -50°F (-46°C) to 350°F (177°C))
- Complete with high-visibility permanent safety labels (English, French and Spanish)
- The **SAL521** labels can be written-on to identify the responsible person and then erased for the next job

Model No.	Mfg. No.	For Electrical Plugs Sizes Up To	Price /Each
SAL520	487	2 1/4" Dia. x 3 1/4" w/Cord Dia. up to 3/4" (Most 110- and Many 220-Volt Plugs)	18.60
SAL521	488	3" Dia. x 6" w/Cord Dia. up to 3/4" (Most 220- and 550-Volt Plugs)	24.30



## CIRCUIT BREAKER SWITCH PADLOCKS

- Provides the flexibility to effectively lock out breaker switches
- Flexi-cable allows the lock body to be moved out of the way and panel door to be closed properly
- Fits the tight space constraints within a circuit breaker shutoff boxes
- Numerous key changes are available to minimize the possibility of unwanted key duplication
- 1 1/8" wide steel body; 4-pin cylinder; 5" flexible steel cable

Model No. SAL525  
Mfg. No. 7CSRED  
Price/Each \$14.40



## UNIVERSAL WALL SWITCH COVERS

- Prevent unintentional toggling of wall switch to "ON" position
- One-time installation uses the existing wall plate screws
- Hinges open for unobstructed normal operation switch
- Lock the switch in either the "ON" or "OFF" position by closing the cover over the switch, then applying padlock
- Locks out both toggle and decor paddle wall switches

Model No. SAO708  
Mfg. No. 496B  
Price/Each \$12.30



## GRIP TIGHT™ CIRCUIT BREAKER LOCKOUTS

- Exclusive design accommodates virtually all styles of breaker toggles
- Fits all American Lock® and Master Lock® safety padlocks and hasps
- Two products replace at least five. **SAO595** is used for single and double breaker toggles, while **SAO594** is appropriate for tall and wide breaker toggles
- Grips tight with a simple thumb turn and clamping handle
- Narrow profile permits side-by-side breaker lockout
- Made of powder coated steel and reinforced polymer to operate in harsh conditions

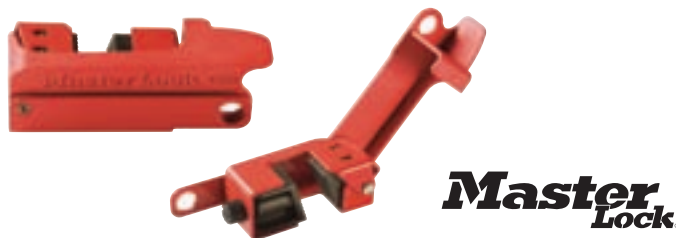

Model No.	Mfg. No.	Description	Price /Each
SAO594	491B	Tall & Wide Toggles	12.30
SAO595	493B	Standard Single and Double Toggles	9.16
SAO707	506	Set of each SAO594 and SAO595	21.10

## COMPACT PLUG PRONG LOCKOUTS

- Compact design locks out 110 V – 120 V electrical plugs
- Works with two-prong or two-prong with ground plugs
- Can be used with safety padlocks or lockout hasps, no key needed
- New design can now accommodate larger shackle locks and safety hasps



Model No.	Mfg. No.	Description	Price /Each
SAR841	S2005	Electrical Outlet Lockout	12.80

# LOCKS & LOCKOUT DEVICES



## CIRCUIT BREAKER LOCKOUTS

### SINGLE POLE CIRCUIT BREAKER LOCKOUT

Requires a switch breaker with a recessed hole in it. Accommodates breakers up to 9/16" (14 mm) wide.

**Model No. SC909**  
**Mfg. No. CB01**  
**Price/Each \$7.00**



SC909



SC910



SC911

### DOUBLE POLE CIRCUIT BREAKER LOCKOUT

Requires the breakers to be connected with a cross bar for lockout applications. Accommodates breakers with an overall width of 1 7/8" (48 mm).

**Model No. SC910**  
**Mfg. No. CB02**  
**Price/Each \$12.30**

### SINGLE POLE CIRCUIT BREAKERS LOCKOUT

Does not require a switch breaker with a recessed hole in it. Accommodates circuit breakers with an overall width of 1/2" (13 mm).

**Model No. SC911**  
**Mfg. No. CB03**  
**Price/Each \$5.00**



**Honeywell**

## STEERING WHEEL COVERS

- Bilingual steering wheel covers notify employees not to start or move vehicles
- Lock in place with a SA876 hasp and a safety padlock (see pages 769-772 for padlocks)
- For added security, use SED597 lockout cable around the steering wheel and foot pedals
- Three sizes available for various diameter steering wheels



Model No.	Mfg. No.	Steering Wheel Diameter"	Price /Each
SED181	KDD712	16	55.00
SED182	KDD723	20	72.40
SED183	KDD734	24	86.20

## ELECTRICAL PLUG LOCKOUTS

- Lockout electrical plugs from any accidental reconnection
- Made of high visibility red plastic which is entirely dielectric
- Model SA864 will accept 110 V, plug 3 1/4" x 1 3/4" with a maximum of 1/2" cable
- Model SA865 will accept 220 to 550 V, plug 6 3/4" x 3" with a maximum 1" cable



**Honeywell**

Model No.	Mfg. No.	Dimensions			Volts	Price /Each
		L"	W"	H"		
SA864	LP110	3 1/4	x 1 3/4	x 1 3/4	110	14.60
SA865	LP550	6 3/4	x 3	x 3	220-550	21.50

## SEAL TIGHT™ HANDLE-ON BALL VALVE LOCKOUTS

- Patent-pending innovative design locks out the ball valves from 1/4" to 4"
- Lightweight and compact ergonomic design allows easy use and storage
- Constructed of metal alloy, this lockout device withstands corrosive environments and operates in extreme temperatures
- Works in virtually all ball valve installations – metal and PVC valves, insulated pipes, and pipes with tight access due to close proximity to other valves, pipes or structures
- Works with all Master Lock® and American Lock® safety padlocks and safety hasps

**Model No. SAS463**  
**Mfg. No. S3068**  
**Price/Each \$48.50**



**PADLOCK NOT INCLUDED**

## ADJUSTABLE BALL VALVE LOCKOUTS

- Fits valves 1/2" to 2" in size
- Four locking holes are compatible with all Master Lock® and American Lock® safety padlocks
- Locks valve in the closed position
- Includes removable handle insert to accommodate a wide range of handle designs and dimensions
- Durable, lightweight thermoplastic material performs effectively in extreme environments; -40°F to 200°F

Model No. SE1878  
Mfg. No. S3081  
Price/Each \$38.10

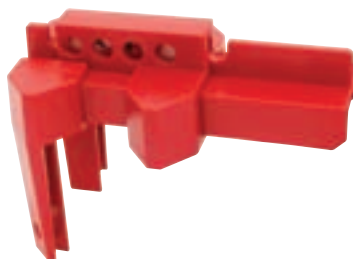

**Master Lock**

## BUTTERFLY VALVE LOCKOUT

- Adjustable butterfly valve lockout
- Locks out valve in seconds by feeding **SED597** (S806) - 6 ft cable or **SED596** (S806CBL3) - 3 ft cable lockout device through desired eyelet and around valve neck
- Durable, lightweight thermoplastic material is chemical resistant and performs effectively in extreme environments
- Directional application arrows allow for ease of installation and minimize user error
- Stainless steel rivet allows device to smoothly pivot open and closed to ensure proper fit

**Master Lock**

SEK636



SEK637

Model No.	Mfg. No.	Description	Price /Each
SEK636	S3920	Lockout Device Only	29.00
SEK637	S3921	Lockout Device & SED596 Adjustable Cable Lockout	56.50

## STANDARD BALL VALVE LOCKOUT DEVICES

- Patented design fits all major brand ball valves
- Simple one-piece design makes it easy to use
- Assist in compliance with lockout regulations
- Fits most valves up to 3"

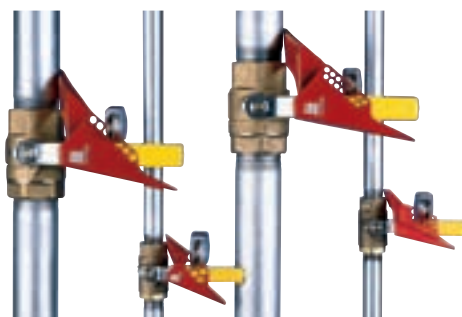

**BRADY®**

Model No.	Mfg. No.	Valve Size"	Max. Shackle Diameter"	Max. Handle Width"	Max. Handle Thickness"	Material	Price /Each
SAC636	65692	1/4 - 1	3/8	1	3/4	Powder-coated Steel	34.78
SAC637	65693	1 1/4 - 3	3/8	9/10	1/2	Powder-coated Steel	45.21

## BALL VALVE LOCKOUTS

Available in three sizes for valves from 3/8" to 8". Constructed of heavy-duty, high visibility red polypropylene that is fully dielectric and chemical and solvent resistant. Model **SA857** allows you to lock valves in the open or closed position.

**Honeywell**

Model No.	Mfg. No.	Fits Valve Size"	Price /Each
SA857	BS01R	3/8 to 1 1/4	18.30
SA858	BS02R	1 1/2 to 2 1/2	29.60
SA859	BS03R	2 to 8	34.60





# LOCKS & LOCKOUT DEVICES

## SEAL TIGHT™ BALL VALVE LOCKOUTS

- Compact, lightweight, flexible and easy to use, the Seal Tight™ valve lockout works on virtually every valve size and applications
- Eliminates the risk of accidentally moving a handle by removing it and concealing the stem
- Effectively locks out all valves from 3/8" to 4", thus eliminating specific valve lockout systems
- Simple to apply, with an intuitive wrapping strap and locking mechanism
- Works on virtually all valves; metal and PVC, insulated pipes, ceiling or wall-mounted pipes and hard to reach valves
- Made of PVC polyester fabric and HDPE plastic, it withstands corrosive environments and operates in temperatures from -40°F to 300°F

Model No. SAO596  
Mfg. No. 468L  
Price/Each \$38.40

**Master  
Lock.**



## OVERSIZE PLUG & HOIST COVERS

- Offers broad application solutions sized at 7" diameter by 17" tall
- Insert PVC tubing to block access to control buttons for hoist control lockout
- Flexible and durable rip-stop nylon bag fits easily in safety tool boxes
- Lock out with up to six padlocks or hasps
- Trilingual lock out warning printed on bag

Model No. SAO706  
Mfg. No. 453L  
Price/Each \$40.10



**Master  
Lock.**

## CONFINED SPACE COVERS

- Signage and barrier protection all-in-one
- Provide OSHA required warnings
- Halt unauthorized entry
- Easy to use
- Ultra durable
- Guard against weather and debris
- Prevent infestation
- Operating temperature: -40°F to 200°F
- Sizing and fit depend on flange dimensions

**Small** - Fits standard man-ways 20" to 23" (508 mm to 584.2 mm)  
**Medium** - Fits standard man-ways 23" to 28" (584.2 mm to 711.2 mm)  
**Large** - Fits standard man-ways 28" to 34" (711.2 mm to 863.6 mm)  
**X-Large** - Fits standard man-ways 32" to 39" (812.8 mm to 990.6 mm)



**Master  
Lock.**

### ELASTIC, NON-LOCKING ENGLISH

Model No.	Mfg. No.	Size	Price /Each
SDL009	S201CSS	Small	163.00
SDL010	S201CSM	Medium	178.00
SDL011	S201CSL	Large	193.00
SDL012	S201CSXL	X-Large	207.00

### VENTILATED, LOCKABLE ENGLISH

Model No.	Mfg. No.	Size	Price /Each
SDL013	S202CSS	Small	252.00
SDL014	S202CSM	Medium	264.00
SDL015	S202CSL	Large	276.00
SDL016	S202CSXL	X-Large	288.00

### SOLID, LOCKABLE ENGLISH

Model No.	Mfg. No.	Size	Price /Each
SDL017	S203CSS	Small	235.00
SDL018	S203CSM	Medium	252.00
SDL019	S203CSL	Large	276.00
SDL020	S203CSXL	X-Large	264.00

Also available Bilingual

784

MATERIAL  
HANDLING &  
STORAGE

JANITORIAL &  
MAINTENANCE

SAFETY  
EQUIPMENT  
& SUPPLIES

WELDING &  
METALWORKING

TOOLS &  
EQUIPMENT

SHIPPING &  
PACKAGING

INSTRUMENTS,  
SCALES &  
ELECTRICAL

OFFICE  
PRODUCTS

## ROTATING GATE VALVE LOCKOUTS

- Outward/inward rotation allows for easier installation and storage
- Unique, patent-pending outward rotation allows for easier installation in confined space applications
- Surrounds the valve operating handle, protects against accidental valve opening
- Each size rotates into itself to fit effectively into safety tool boxes
- Each size nests within the next larger size to save space in storage
- Tough, lightweight, dielectric Xenex™ thermoplastic bodies withstand chemicals; perform effectively in extreme conditions (temperature range -50°F (-46°C) to 350°F (177°C))
- Up to four workers can apply their personal safety locks
- Red lockout colour identifies the safety lockout application
- Complete with high-visibility permanent safety labels (English, French and Spanish) that can be written on to identify the responsible person and then erased for the next job



SAL529



SAL528



SAL531

**Master  
Lock.**

Model No.	Mfg. No.	Description	Price /Each
SAL526	480	Fits 1" to 3" Dia. Valve Handle	21.90
SAL527	481	Fits 2" to 5" Dia. Valve Handle	33.60
SAL528	482	Fits 4" to 6 1/2" Dia. Valve Handle	45.70
SAL529	483	Fits 6" to 10" Dia. Valve Handle	59.70
SAL530	484	Fits 8" to 13" Dia. Valve Handle	99.60
SAL531	485	1 Set Consists of 1 x SAL526, SAL527, SAL528, SAL529 & SAL530	239.00



## CUSTOM TAGS MADE EASY!

- No set-up fees
- Any print colors
- Full-color graphics and images, including design, image, and logo
- Choose a message with any letter font
- Available barcoding, sequential numbering, and tear-off perforations – **Call us for details**



## HOW TO ORDER CUSTOM TAGS

### STEP 1: MESSAGE, DESIGN

Develop your tag – provide message, layout, design and color.

### STEP 2: SELECT MATERIAL AND SIZE

Consider tag placement, intended application, and environment.

### STEP 3: FINISHING OPTIONS

Determine how you will install the tag. Call us for available options.

### STEP 4: DECIDE ON QUANTITY

No need to order huge quantities – You can order as few as 25.

Call, e-mail, or fax us to place your order!

### SIZES:

4 1/4" x 2 1/8"

5 3/4" x 3 1/4"

8 1/2" x 3 7/8"

Other sizes upon request



### PF-CARDSTOCK TAGS

Tear-resistant and waterproof tags last longer than standard cardstock tags.

Tags are pulp-free – no wood pulp or paper content – unlike regular cardstock. They are pliable, yet will not rip or breakdown in moisture.

Tags do not tear readily when tugged on. Ideal for indoor use and short term outdoor exposure. The scuff-resistant, matte surface is easy to write on.

- 10-mil polyolefin-based material
- Thin and flexible
- Top has 3/8" plain hole

### RP-PLASTIC TAGS & HS-LAMINATE TAGS

Durable tag withstands pulls and tears in dirt and grease environments.

Plastic tags are water-resistant – to withstand weather conditions.

The rigid plastic is flexible, yet will not readily break down over a wide temperature range. Good for indoors and outdoors use. Writable surface is abrasion resistant.

- 15-mil rigid plastic material
- Flexible, yet durable – withstands stretching and ripping
- Top has 3/8" hole reinforced with metal grommet to prevent pull off

### HS-LAMINATE TAGS

Tags are designed to withstand tough and abusive conditions.

HS-Laminate is a composite of all poly materials hard sealed on both sides with no edge seams. Matte surface is scratch resistant, yet easy to write on. Waterproof tags are ideal for extreme weather conditions.

- Tear-proof, weather-proof, chemical-resistant material withstands dirt and grease environments
- Thick laminate stands up to abuse and rough handling
- 3/8" top hole is reinforced with a pull-proof, metal grommet

Can't find what you're looking for?  
Call us today!



# SAFETY TAGS



## SAFETY TAGS

- Header style tags meet Occupational Safety and Health Administration requirements
- Choose from a variety of common styles and legends that apply to a variety of situations
- Tags are available in two materials: **PF-cardstock** and **RV-plastic**
- 25 per package

### PF-Cardstock

- 5 7/8" x 3 1/8" with 3/8" hole
- Pliable, 10-mil plastic
- Pulp-free, no wood-paper content
- Waterproof, tear-resistant for short-term use

### RV-Plastic

- 5 7/8" x 3 3/8" with 3/8" hole, reinforced with metal grommet
- 15-mil tear-resistant plastic
- Weather and chemical-resistant

## BLANK HEADER TAGS

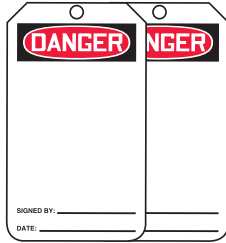

Front Back  
SAU650  
SAU651



Front Back  
SAU654  
SAU655



Front Back  
SAU658  
SAU659



Front Back  
SAU662  
SAU663

Material  
PF-Cardstock  
RV-Plastic

## STANDARD SAFETY TAGS



SAT022  
SAT045



SAU606  
SAU607



SAU610  
SAU611



SAU614  
SAU615



SEI941  
SEI942

Material  
PF-Cardstock  
RV-Plastic



SAU618  
SAU619



SAU626  
SAU627



SAU634  
SAU635

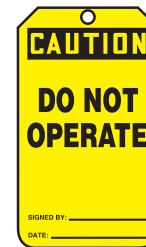

SAU638  
SAU639



Standard Back

Material  
PF-Cardstock  
RV-Plastic

## EQUIPMENT STATUS & INSPECTION TAGS

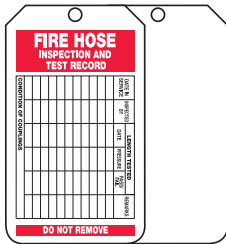

Front Back  
SAU702  
SAU703



Front Back  
SAU698  
SAU699



Front Back  
SAU706  
SAU707



Front Back  
SAU714  
SAU715

Material  
PF-Cardstock  
RV-Plastic

Material	Size"	Price/Pkg. 25
PF-Cardstock	5 7/8 x 3 1/8	23.70
RV-Plastic	5 7/8 x 3 3/8	64.30



ACCUFORM®

## EQUIPMENT STATUS & INSPECTION TAGS (CONTINUED)



Front Back

SAU718  
SAU719



Front Back

SAU734  
SAU735



Front Back

SAU738  
SAU739



Front Back

SAU742  
SAU743

Material  
PF-Cardstock  
RV-Plastic

## LOCKOUT TAGS



SAU778  
SAU779



SAU782  
SAU783



SAU790  
SAU791



SAU786  
SAU787

Material  
PF-Cardstock  
RV-Plastic



SAU806  
SAU807



SAU802  
SAU803



SAU810  
SAU811

Material  
PF-Cardstock  
RV-Plastic

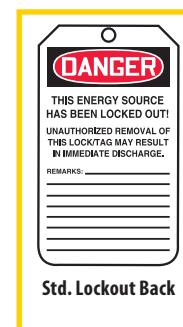

Std. Lockout Back

## FRENCH BLANK HEADER TAGS



SED646  
SED647



SED648  
SED649



SED650  
SED651



SED652  
SED653

Material  
PF-Cardstock  
RV-Plastic

Material	Size*	Price/Pkg. 25
PF-Cardstock	5 7/8 x 3 1/8	23.70
RV-Plastic	5 7/8 x 3 3/8	64.30



ACCUFORM®



# SAFETY TAGS

## FRENCH STANDARD SAFETY TAGS

### STANDARD SAFETY



SAU834  
SAU835



SAU838  
SAU839



SAU846  
SAU847



SAU842  
SAU843

Material  
PF-Cardstock  
RV-Plastic



SAU858  
SAU859



SAU854  
SAU855



SAU862  
SAU863



SAU866  
SAU867

Material  
PF-Cardstock  
RV-Plastic



Standard French  
Back

### FRENCH EQUIPMENT STATUS & INSPECTION TAGS



SED654  
SED655



SED656  
SED657



SED658  
SED659



SED660  
SED661

Material  
PF-Cardstock  
RV-Plastic

### FRENCH LOCKOUT TAGS



SAU870  
SAU871



SAU874  
SAU875



SAU878  
SAU879



SAU882  
SAU883

Material  
PF-Cardstock  
RV-Plastic



Std. French  
Lockout Back

Material	Size"	Price/Pkg. 25
PF-Cardstock	5 7/8 x 3 1/8	23.70
RV-Plastic	5 7/8 x 3 3/8	64.30



ACCUFORM®

## ENGLISH LOCKOUT IDENTIFICATION TAGS

- These durably tags are designed to create visibility and awareness
- All tags have 3/8" grommets and are 2 3/4" x 6 1/2" in size
- For use indoor or outdoor
- Tags can be written on with most types of markers and pens
- Colour: Yellow on red
- 25/pkg



SC935



SC937



SC938

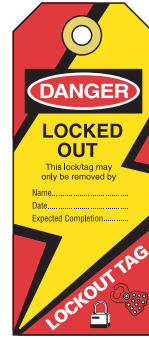

SC939

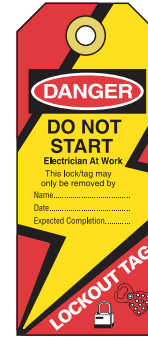

SC940



Priced per Package

Model No.	Mfg. No.	Description	Price /Each
SC935	32669	This Equipment Locked Out	82.10
SC937	32668	Do Not Operate	82.10
SC938	32663	Do Not Operate-Maintenance Dept	82.10
SC939	32667	Locked Out	82.10
SC940	32665	Do Not Start-Electrician At Work	82.10

## FRENCH LOCKOUT IDENTIFICATION TAGS

- All lockout tags are 3" x 5 3/4" in size and made of rugged stain and mildew resistant 20 mil styrene
- The textured surface allows you to write all important information such as names, dates and expected completion time
- These tags are sold in packs of 25 with necessary fasteners
- Available with grommets for greater strength
- Tags are striped red for easier identification



SE338



SE339



SE340



SE341



SE342



SE343



SE344



Priced per Package

Model No.	Mfg. No.	Description	Price /Each
SE338	ELF290G/1	Danger - Ne pas opérer	47.10
SE339	ELF265G/1	Danger - Équipement verrouillé	47.10
SE340	ELF255G/1	Danger - Ne pas ouvrir	47.10
SE341	ELF250G/1	Danger - Ne pas démarrer	47.10
SE342	ELF235G/1	Danger - Ne pas opérer - Département de maintenance	47.10
SE343	ELF230G/1	Danger - Équipement verrouillé - Ne pas opérer	47.10
SE344	ELF240G/1	Danger - Équipement verrouillé - Électriciens au travail	47.10

# SAFETY TAGS

## TAGS BY-THE-ROLL: NEVER RUN OUT OF TAGS AGAIN!

- Tag size: 6 1/4" x 3", with 3/8" hole
- 10-mil PF-Cardstock tags
- Tear-resistant, waterproof 'pulp-free' material
- Writable matte surface
- Dispenser size: 9 1/4" x 9 1/4" x 3 1/2"
- Available in rolls of 100 or 250 tags



Per Roll	Price/Roll
100	78.60
250	175.00



SAS784

### ENGLISH TAGS



Front Back  
100/Roll 250/Roll  
SAS755 SAS449

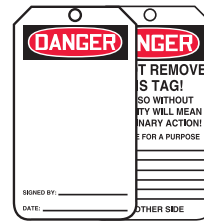

Front Back  
100/Roll 250/Roll  
SAS757 SAS782



Front Back  
100/Roll 250/Roll  
SAS783 SAS784



Front Back  
100/Roll 250/Roll  
SAS785 SAS764



Front Back  
100/Roll 250/Roll  
SEI937 SEI938



Front Back  
100/Roll 250/Roll  
SEI939 SEI940

### FRENCH TAGS (ROLLS OF 250 TAGS)

Model No.	Mfg. No.	Description
SAS452	TAR123	<i>Danger; Ne pas faire fonctionner</i>
SAS453	TAR127	<i>Danger; Ne pas faire fonctionner (w/Stripes)</i>
SAS454	TAR425	<i>Danger; Verrouillé; Ne pas faire fonctionner (w/Stripes)</i>

## LOOP 'N STRAP™ TAGS

- Attach tags by self-fastening strap for quick marking
- 0.023" polyethylene plastic tags resist dirt, grease and moisture
- Write on tag with permanent marker
- Tag body is 5 1/4" X 3 1/4", with 1 3/8" x 6" strap
- Available in packages of 25

Price/Pkg. of 25  
64.30



## QUICKTAGS™

- Compact and convenient safety tag dispensing system
- Available as a set that includes 100 tags in a self-contained plastic dispenser with keyholes on the underside to mount near workstations
- Simply pull the tag out from the dispenser and separate at the perforation
- Re-load empty dispenser with refill packs of 100
- Reusable plastic dispenser is mountable or portable
- Tags are tear-resistant and waterproof, made from pulp-free polyolefin based material
- Writable matte surface
- Dispenser size: 8" x 4" x 1 3/4"
- Tag size: 6 1/4" x 3", 10-mil cardstock



### ENGLISH TAGS

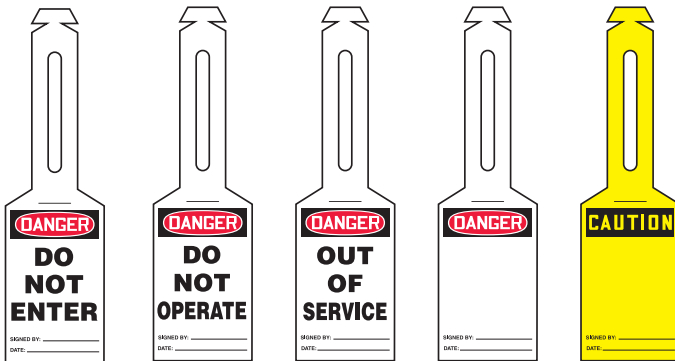

SAS435 SAS747 SAS748 SAS749 SAS750

### FRENCH TAGS

Model No.	Mfg. No.	Description
SAS440	TAL357	<i>Danger; Ne Pas Entrer</i>
SAS441	TAL351	<i>Danger; Ne pas faire fonctionner</i>
SAS442	TAL356	<i>Danger; Hors service</i>
SAS443	TAL322	<i>Danger</i>
SAS444	TAL326	<i>Attention</i>



	Model No.	Model No.	Model No.	Model No.	Price /Each
<b>ENGLISH</b>					
QuickTags™	SEI929	SEI930	SEI931	SEI932	84.80
Refill 100/pack	SEI933	SEI934	SEI935	SEI936	75.80
<b>FRENCH</b>					
QuickTags™	SEL124	SEL125	SEL126	SEL127	84.80
Refill 100/pack	SEL128	SEL129	SEL130	SEL131	75.80





## BLANK TAGS

We offer tags available blank so that you can write any message in pen, pencil, or marker. Use for coding, marking, quick identification, production status, or inventory.



## MANILA BLANK CARDSTOCK TAGS

- 13 pt. Manila Cardstock Tags have patch-reinforced 3/16" hole
- Available plain hole, looped with 12" galvanized steel wire, or looped with 12" cotton string
- Available in pack of 100, or box of 1000

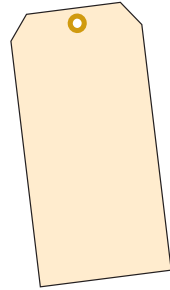

Hole Only Size No.	Size"	100	1000	Price 100/Pkg.	Price 1000/Box
1	2 3/4 x 1 3/8	SI966	SAG441	8.19	21.40
2	3 1/4 x 1 5/8	SAW514	SAG442	7.59	23.40
3	3 3/4 x 1 7/8	SI968	SAG443	8.91	24.90
4	4 1/4 x 2 1/8	SI969	SAG444	9.58	27.10
5	4 3/4 x 2 3/8	SI970	SAG445	10.40	28.80
6	5 1/4 x 2 5/8	SI971	SAG446	9.69	30.90
7	5 3/4 x 2 7/8	SAW515	SAG447	12.10	34.50
8	6 1/4 x 3 1/8	SAW516	SAG448	13.40	37.40

Hole with Wire Size No.	Size"	100	1000	Price 100/Pkg.	Price 1000/Box
1	2 3/4 x 1 3/8	SAW517	SAG449	15.40	68.50
2	3 1/4 x 1 5/8	SAW518	SAG450	20.60	69.90
3	3 3/4 x 1 7/8	SAW519	SAG451	16.40	71.00
4	4 1/4 x 2 1/8	SBB051	SAG452	17.80	72.30
5	4 3/4 x 2 3/8	SBB053	SAG453	17.30	73.20
6	5 1/4 x 2 5/8	SAW522	SAG454	19.50	77.50
7	5 3/4 x 2 7/8	SAW523	SAG455	20.50	79.90
8	6 1/4 x 3 1/8	SAW524	SAG456	21.60	80.20

Hole with String Size No.	Size"	100	1000	Price 100/Pkg.	Price 1000/Box
1	2 3/4 x 1 3/8	SAW525	SAG457	14.20	59.70
2	3 1/4 x 1 5/8	SAW526	SAG458	17.80	61.00
3	3 3/4 x 1 7/8	SAW527	SAG459	14.10	62.50
4	4 1/4 x 2 1/8	SAW528	SAG460	15.60	64.20
5	4 3/4 x 2 3/8	SAW529	SAG461	16.50	66.50
6	5 1/4 x 2 5/8	SAW530	SAG462	17.30	68.70
7	5 3/4 x 2 7/8	SAW531	SAG463	18.30	71.10
8	6 1/4 x 3 1/8	SAW532	SAG464	19.40	73.70

## STANDARD COLOR BLANK CARDSTOCK TAGS

- 13 pt. coated color cardstock tags have a patch-reinforced 3/16" hole
- Available plain hole, looped with 12" galvanized steel wire, or looped with 12" cotton string
- Available in pack of 100, or box of 1000

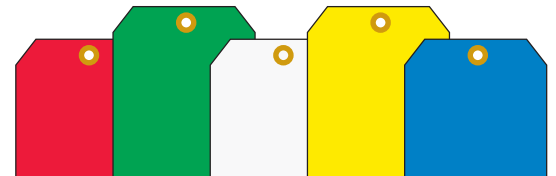

Hole Only Size No.	Size"	Blue		Green		Red		White		Yellow		Price 100/Pkg.	Price 1000/Box
		100	1000	100	1000	100	1000	100	1000	100	1000		
1	2 3/4 x 1 3/8	SAW536	SAG501	SAW560	SAG486	SAW584	SAG479	SAW608	SAG465	SAW632	SAG472	9.37	23.90
2	3 1/4 x 1 5/8	SAW537	SAG502	SAW561	SAG487	SAW585	SAG480	SAW609	SAG466	SAW633	SAG473	12.30	26.40
3	3 3/4 x 1 7/8	SAW538	SAG503	SAW562	SAG488	SAW586	SAG481	SAW610	SAG467	SAW634	SAG474	11.20	29.30
4	4 1/4 x 2 1/8	SAW539	SAG504	SAW563	SAG489	SAW587	SAG482	SAW611	SAG468	SAW635	SAG475	12.30	32.60
5	4 3/4 x 2 3/8	SAW540	SI978	SAW564	SI977	SAW588	SI976	SAW612	SI974	SAW636	SI975	13.60	34.80
6	5 1/4 x 2 5/8	SAW541	SAG505	SAW565	SAG490	SAW589	SAG483	SAW613	SAG469	SAW637	SAG476	14.90	40.70
7	5 3/4 x 2 7/8	SAW542	SAG506	SAW566	SAG491	SAW590	SAG484	SAW614	SAG470	SAW638	SAG477	20.40	45.10
8	6 1/4 x 3 1/8	SAW543	SAG507	SAW567	SAG492	SAW591	SAG485	SAW615	SAG471	SAW639	SAG478	18.30	44.80

Hole with Wire Size No.	Size"	Blue		Green		Red		White		Yellow		Price 100/Pkg.	Price 1000/Box
		100	1000	100	1000	100	1000	100	1000	100	1000		
1	2 3/4 x 1 3/8	SAW552	SAG555	SAW576	SAG539	SAW600	SAG531	SAW624	SAG515	SAW648	SAG523	17.60	71.10
2	3 1/4 x 1 5/8	SAW553	SAG556	SAW577	SAG540	SAW601	SAG532	SAW625	SAG516	SAW649	SAG524	23.10	73.40
3	3 3/4 x 1 7/8	SAW554	SAG557	SAW578	SAG541	SAW602	SAG533	SAW626	SAG517	SAW650	SAG525	19.40	76.10
4	4 1/4 x 2 1/8	SAW555	SAG558	SAW579	SAG542	SAW603	SAG534	SAW627	SAG518	SAW651	SAG526	20.50	79.20
5	4 3/4 x 2 3/8	SAW556	SAG559	SAW580	SAG543	SAW604	SAG535	SAW628	SAG519	SAW652	SAG527	21.80	80.60
6	5 1/4 x 2 5/8	SAW557	SAG560	SAW581	SAG544	SAW605	SAG536	SAW629	SAG520	SAW653	SAG528	23.20	86.80
7	5 3/4 x 2 7/8	SAW558	SAG561	SAW582	SAG545	SAW606	SAG537	SAW630	SAG521	SAW654	SAG529	31.20	91.00
8	6 1/4 x 3 1/8	SAW559	SAG562	SAW583	SAG546	SBB093	SAG538	SAW631	SAG522	SAW655	SAG530	26.50	95.60

Hole with String Size No.	Size"	Blue		Green		Red		White		Yellow		Price 100/Pkg.	Price 1000/Box
		100	1000	100	1000	100	1000	100	1000	100	1000		
1	2 3/4 x 1 3/8	SAW544	SAG611	SAW568	SAG595	SAW592	SAG587	SAW616	SAG571	SAW640	SAG579	15.50	62.50
2	3 1/4 x 1 5/8	SAW545	SAG612	SAW569	SAG596	SAW593	SAG588	SAW617	SAG572	SAW641	SAG580	20.30	64.20
3	3 3/4 x 1 7/8	SAW546	SAG613	SAW570	SAG597	SAW594	SAG589	SAW618	SAG573	SAW642	SAG581	17.30	67.20
4	4 1/4 x 2 1/8	SAW547	SAG614	SAW571	SAG598	SAW595	SAG590	SAW619	SAG574	SAW643	SAG582	18.30	70.40
5	4 3/4 x 2 3/8	SAW548	SAG615	SAW572	SAG599	SAW596	SAG591	SAW620	SAG575	SAW644	SAG583	19.60	74.20
6	5 1/4 x 2 5/8	SAW549	SAG616	SAW573	SAG600	SAW597	SAG592	SAW621	SAG576	SAW645	SAG584	21.10	78.00
7	5 3/4 x 2 7/8	SAW550	SAG617	SAW574	SAG601	SAW598	SAG593	SAW622	SAG577	SAW646	SAG585	22.50	82.20
8	6 1/4 x 3 1/8	SAW551	SAG618	SAW575	SAG602	SAW599	SAG594	SAW623	SAG578	SAW647	SAG586	24.40	86.80

# IDENTIFICATION TAGS

## TYVEK® BLANK TAGS

- Tyvek® is a lightweight pressure-bonded fibre
- Flexible 7.5-pt. material is abrasion- and tear-resistant
- Can withstand moisture, chemicals, and frequent handling
- Tags have patch- and metal-reinforced 3/16" hole
- Hole is available plain or looped with 12" galvanized steel wire
- Available in pack of 100 or box of 1000



### WHITE TYVEK®

Hole Only Size No.	Size"	100	1000	Price 100/Pkg.	Price 1000/Box
5	4 3/4 x 2 3/8	SAW683	SAG747	24.70	120.00
8	6 1/4 x 3 1/8	SAW694	SAG749	38.90	123.00

Hole with Wire Size No.	Size"	100	1000	Price 100/Pkg.	Price 1000/Box
5	4 3/4 x 2 3/8	SAW695	SAG750	31.80	134.00
8	6 1/4 x 3 1/8	SAW697	SAG752	46.10	218.00



### COLOURED TYVEK®

Hole Only Size No.	Size"	Blue 100	Green 100	Red 100	Yellow 100	Price 100/Pkg.
5	4 3/4 x 2 3/8	SAW656	SAW665	SAW674	SAW686	44.10
8	6 1/4 x 3 1/8	SAW658	SAW667	SAW676	SAW535	59.30

Hole With Wire Size No.	Size"	Blue 100	Green 100	Red 100	Yellow 100	Price 100/Pkg.
5	4 3/4 x 2 3/8	SAW662	SAW671	SAW680	SAW691	57.60
8	6 1/4 x 3 1/8	SAW664	SAW673	SAW682	SAW693	67.40

## FLUORESCENT BLANK CARDSTOCK TAGS

- 10 pt. fluorescent cardstock tags have patch-reinforced 3/16" hole
- Available plain hole, looped with 12" galvanized steel wire, or looped with 12" cotton string
- Available in pack of 100, or box of 1000

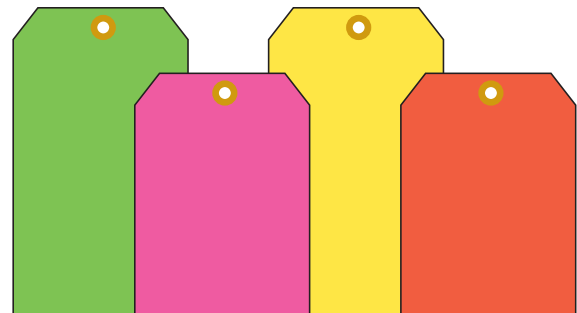

### HOLE ONLY

Size No.	Size"	Fluorescent Green 100	Fluorescent Pink 100	Fluorescent Red 100	Fluorescent Yellow 100	Price 100/Pkg.
5	4 3/4 x 2 3/8	SAW698	SAW716	SAW734	SAW752	18.40
6	5 1/4 x 2 5/8	SAW700	SAW718	SAW736	SAW754	20.50
8	6 1/4 x 3 1/8	SAW702	SAW720	SAW738	SAW756	25.50

### HOLE WITH WIRE

Size No.	Size"	Fluorescent Green 100	Fluorescent Pink 100	Fluorescent Red 100	Fluorescent Yellow 100	Price 100/Pkg.
5	4 3/4 x 2 3/8	SAW704	SAW722	SAW740	SAW758	26.60
6	5 1/4 x 2 5/8	SAW706	SAW724	SAW742	SAW760	28.70
8	6 1/4 x 3 1/8	SAW708	SAW726	SAW744	SAW762	33.70

### HOLE WITH STRING

Size No.	Size"	Fluorescent Green 100	Fluorescent Pink 100	Fluorescent Red 100	Fluorescent Yellow 100	Price 100/Pkg.
5	4 3/4 x 2 3/8	SAW710	SAW728	SAW746	SAW764	24.50
6	5 1/4 x 2 5/8	SAW712	SAW730	SAW748	SAW766	26.00
8	6 1/4 x 3 1/8	SAW714	SAW732	SAW750	SAW768	31.50

## TAG FINISHING OPTIONS



### STRING TIES

- 12" string ties
- Available in Bundles of 100



### BEADED NYLON TIES

- 5" white nylon 6/6
- Self locking design with 18-lb pull strength



### SNAP HOOK LOOP

- Zinc-plated steel loop
- Inside dimensions: 1 1/2" x 2 13/16"



Model No.	Price/Bn.
SAU888	12.10

Model No.	Qty.	Price/Bn.
SAU890	100/Pkg.	11.30
SAU889	1000/Pkg.	101.00

Model No.	Qty.	Price/Bn.
SAU891	100/Pkg.	64.90

## TAG HOLDERS



- Hold a pack of tags in the location they are needed
- Plastic single-pocket tag holder
- 9" H x 4" W aluminum back
- Four corner mounting holes
- Adhesive mounting strips included



Model No.	Price/Each
SAT748	26.20

## BLANK TAGS

- Identify equipment, materials and pipes by stamping description directly onto tag



SDN065

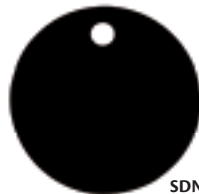

SDN072

SDN073



SDN076

Priced per Package

Model No.	Mfg. No.	Material	Shape	Tag Size"	Hole Size"	Wt. lbs.	Qty /Pkg.	Price /Each
SA962	947B	Brass	Octagon	1 1/4	3/16	1.9	100	90.60
SDN075	41272	Brass	Rectangle	1 x 2	1/8	2.3	100	146.00
SDN077	41292	Brass	Rectangle	1 x 3	1/8	3.7	100	244.00
SA963	1098B	Brass	Round	1 1/2	3/16	2.2	100	116.00
SDN066	41842	Brass	Round	1 1/4	3/16	1.5	100	92.40
SDN067	41849	Brass	Round	1 3/8	3/8	2.9	100	146.00
SDN065	1078B	Brass	Round	1	3/16	0.87	100	57.20
SDN068	1110B	Brass	Round	2	3/16	3.8	100	206.00
SA961	916B	Brass	Square	1 1/4	3/16	1.9	100	98.20
SDN074	43169	Black Anodized Aluminum	Rectangle	1 x 3	1/8	0.056	5	15.80
SDN073	43147	Black Anodized Aluminum	Round	1 1/2	3/16	0.036	5	15.80
SDN072	43167	Red Anodized Aluminum	Rectangle	1 x 3	1/8	0.058	5	16.90
SDN071	43145	Red Anodized Aluminum	Round	1 1/2	3/16	0.036	5	15.80
SDN076	41273	Stainless Steel	Rectangle	1 x 2	1/8	1.9	100	183.00
SDN078	41293	Stainless Steel	Rectangle	1 x 3	1/8	2.9	100	306.00
SDN069	41858	Stainless Steel	Round	1 1/2	3/16	2.1	100	162.00
SDN070	41843	Stainless Steel	Round	1 1/4	3/16	1.3	100	116.00

## NUMBERED BRASS TAGS

- Black filled numbers
- 18-gauge brass
- 3/16" hole
- Available only in unbroken series of 25



Priced per Series

Model No.	Mfg. No.	Number Series	Price /Each
<b>1" TAG DIAMETER</b>			
SDM709	40003	001 - 025	70.80
SDM710	40004	026 - 050	70.80
SDM711	40005	051 - 075	70.80
SDM712	40006	076 - 100	70.80
SDM713	40007	101 - 125	70.80
SDM714	40008	126 - 150	70.80
SDM715	40009	151 - 175	70.80
SDM716	40010	176 - 200	70.80

Model No.	Mfg. No.	Number Series	Price /Each
<b>1.5" TAG DIAMETER</b>			
SA949	40023	001 - 025	75.80
SA950	40024	026 - 050	75.80
SA951	40025	051 - 075	75.80
SA952	40026	076 - 100	75.80
SA953	40027	101 - 125	75.80
SA954	40028	126 - 150	75.80
SA955	40029	151 - 175	75.80
SA956	40030	176 - 200	75.80



# IDENTIFICATION TAGS

## TIES

### LADDER TIES

Lightweight, low cost nylon ties are strong yet flexible. Natural colour. Bags of 1000.



Priced per Bag

Model No.	Mfg. No.	Length"	Bundle Dia. Min" - Max"	Tensile Strength lbs.	Price /Each
PA876	8470	7	1/16 - 1 3/4	40	42.20
PA877	8471	11	1 1/16 - 3	40	47.40



### WIRE TIES

- 26 gauge
  - 12" long
  - 1000/pkg.
- Priced per Package.

Model No. SC960  
Price/Each \$11.00

### PLASTIC TAG FASTENERS

- 5" long
- 200/pkg.

Model No. SI980  
Price/Each \$4.46

Priced per Package

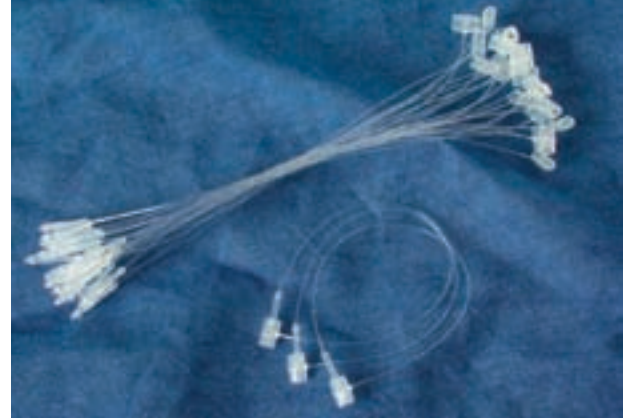

## LEAD SECURITY SEALS & SEALING PRESSES

- Provides security in a wide variety of situations
- Slip twisted wire through the hole in lead seal disc and crush with sealing press
- Can't be opened or tampered with, without detection
- 7/16" diameter lead seals with 10" two-ply annealed steel wires
- Lead sealing press comes with two blank dies



Model No.	Mfg. No.	Description	Price /Each
SA947	27905	Sealing Press	109.00
SA948	27911	Seals, 100/pkg.	29.50

## SPLIT KEY RINGS

Designed for holding and preventing the loss of metal checks and tags.



Rings

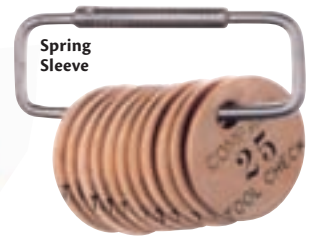

Spring Sleeve

Price per Package

Model No.	Mfg. No.	Description	Qty /Pkg.	Price /Each
SA957	40082	1" Ring	100	28.00
SA958	40084	1 1/2" Ring	100	65.00
SA959	40085	2" Ring	100	91.00
SA960	40087	Spring Sleeve	100	99.40

## S HOOKS

- For quick, permanent fastening of checks and tags
- Easily closed with pliers
- Available in nickel in three sizes
- 100/pkg.



Priced per Package

Model No.	Mfg. No.	Size"	Price /Each
SC945	41003	7/8	20.70
SC944	41004	1 1/8	25.10
SAG889	41005	1 1/2	28.30

## BEADED CHAINS

- For quick, permanent fastening of checks and tags
- Easily closed by hand
- Flexible for hard-to-fasten places
- Available in 4 1/2" nickel or brass plated or 6" brass plated
- 100/pkg.

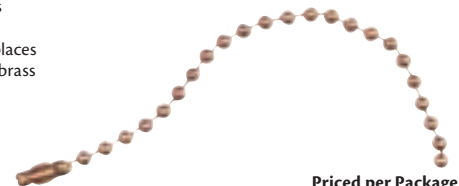

Priced per Package

Model No.	Mfg. No.	Description	Length"	Price /Each
SAG886	40096	Nickel Plated	4 1/2	13.10
SAG887	40097	Brass Plated	4 1/2	18.10
SAG888	40098	Brass Plated	6	23.50

## STEEL HAND STAMPS

- For hand-held, hammer struck applications
- Manufactured from high quality steel
- Induction hardened for added durability and extended life
- Bevelled striking edge prevents breakage and accidents during use
- Stamping end is hardened at 58-62 HRC and the striking end is hardened to 38-43 HRC to prevent splintering
- Letter sets contain 27 pieces, "A" through "Z" and "&"-ampersand
- Number sets contain 9 pieces, "0" through "9", numbers "6" and "9" are interchangeable



**aurora tools®**

Model No.	Stamp Size"	Type	Price /Each
TLZ389	1/8	Number	13.95
TLZ392	1/8	Letter	38.85
TLZ390	3/16	Number	22.80
TLZ393	3/16	Letter	55.40
TLZ391	1/4	Number	29.60
TLZ394	1/4	Letter	72.35

## STEEL HAND STAMP SETS

FOR HAND-HELD HAMMER STRUCK APPLICATIONS



### STANDARD STEEL STAMPS

- Standard high quality stamps for general purpose uses at low cost
- Crowned striking surface
- Textured shank



### HEAVY-DUTY STAMPS

- Heavy-duty marking performance
- Tempered shanks for extra durability and safety
- Crowned striking surface
- Larger shanks than standard



### PREMIER TEMPERED STAMPS

- Large shanks are tempered designed to hold up under continuous hard hammering
- Top quality tempered shanks



### ROUND FACE LOW STRESS STAMPS

- Rounded characters produce minimum stress on the marked surface
- Meets government specifications for minimum stress marking
- Crowned striking surface
- Textured shanks
- Larger shanks than heavy-duty



### LOW STRESS DOT DESIGN STAMPS

- Made on premier size shanks
- Interrupted dot design has a radius on the character end
- Make a permanent mark with minimum stress on the marked metal
- Meets U.S. Atomic Energy specifications
- Applications where metal strength and/or risk of fracture is critical
- Ideal for use in aircraft, missile, oil supply and nuclear power

Model No.	Mfg. No.	Size"	Type	Dimensions Sq." x L"	Wt. lbs.	Price /Each
<b>STANDARD GENERAL PURPOSE</b>						
SF090	20150	3/32	Letters	1/4 x 2 3/8	1.50	77.30
SF091	20521	3/32	Numbers	1/4 x 2 3/8	0.50	25.80
SE234	20200	1/8	Letters	1/4 x 2 3/8	1.50	77.30
SE235	20541	1/8	Numbers	1/4 x 2 3/8	0.50	25.80
SE236	20250	3/16	Letters	5/16 x 2 3/8	2.13	93.80
SE237	20561	3/16	Numbers	5/16 x 2 3/8	0.75	31.30
SE238	20300	1/4	Letters	3/8 x 2 5/8	3.00	113.00
SE239	20581	1/4	Numbers	3/8 x 2 5/8	1.13	37.70
SAK459	20350	3/8	Letters	1/2 x 2 3/4	6.00	165.00
SAK460	20601	3/8	Numbers	1/2 x 2 3/4	2.00	55.00
SF092	20400	1/2	Letters	5/8 x 3	10.00	245.00
SF093	20621	1/2	Numbers	5/8 x 3	3.25	81.70

Model No.	Mfg. No.	Size"	Type	Dimensions Sq." x L"	Wt. lbs.	Price /Each
<b>HEAVY-DUTY</b>						
SF082	20801	3/32	Letters	5/16 x 2 1/2	2.25	130.00
SF083	21340	3/32	Numbers	5/16 x 2 1/2	0.88	43.20
SA932	20851	1/8	Letters	5/16 x 2 1/2	2.30	130.00
SA935	21360	1/8	Numbers	5/16 x 2 1/2	0.88	43.20
SA933	20951	3/16	Letters	3/8 x 2 3/4	3.30	155.00
SA936	21400	3/16	Numbers	3/8 x 2 3/4	1.10	51.70
SA934	21051	1/4	Letters	7/16 x 3	5.00	180.00
SA937	21440	1/4	Numbers	7/16 x 3	1.80	59.90
SF084	21201	1/2	Letters	3/4 x 3 3/4	17.00	433.00
SF085	21500	1/2	Numbers	3/4 x 3 3/4	2.63	144.00

Model No.	Mfg. No.	Size"	Type	Dimensions Sq." x L"	Wt. lbs.	Price /Each
<b>PREMIER TEMPERED</b>						
SF086	22100	3/32	Letters	5/16 x 2 3/4	2.38	149.00
SF087	22841	3/32	Numbers	5/16 x 2 3/4	0.88	49.80
SA938	22150	1/8	Letters	3/8 x 2 3/4	3.30	149.00
SA941	22861	1/8	Numbers	3/8 x 2 3/4	1.30	49.80
SF099	22250	3/16	Letters	7/16 x 2 3/4	3.50	179.00
SA942	22901	3/16	Numbers	7/16 x 2 3/4	1.40	59.60
SA940	22350	1/4	Letters	1/2 x 3	6.00	206.00
SA943	22941	1/4	Numbers	1/2 x 3	2.30	68.80
SF088	22550	1/2	Letters	3/4 x 4	3.25	498.00
SF089	23021	1/2	Numbers	3/4 x 4	6.00	166.00

Model No.	Mfg. No.	Size"	Type	Dimensions Sq." x L"	Wt. lbs.	Price /Each
<b>ROUND FACE LOW STRESS</b>						
SF094	25750	3/32	Letters	5/16 x 2 3/4	2.38	166.00
SF095	26081	3/32	Numbers	5/16 x 2 3/4	0.88	55.30
SF096	25800	1/8	Letters	3/8 x 2 3/4	3.25	166.00
SF097	26101	1/8	Numbers	3/8 x 2 3/4	1.25	55.30
SF098	25850	3/16	Letters	7/16 x 2 3/4	3.50	198.00
SF099	26121	3/16	Numbers	7/16 x 2 3/4	1.38	65.90
SF100	25900	1/4	Letters	1/2 x 3	6.00	260.00
SF101	26141	1/4	Numbers	1/2 x 3	2.25	86.70
SF102	26000	1/2	Letters	3/4 x 4	18.25	598.00
SF103	26181	1/2	Numbers	3/4 x 4	6.00	202.00
SAS103	25950	3/8"	Letters	5/8 x 3 1/8	10.50	395.00
SAS104	26161	3/8"	Numbers	5/8 x 3 1/8	3.50	132.00

Model No.	Mfg. No.	Size"	Type	Dimensions Sq." x L"	Wt. lbs.	Price /Each
<b>LOW STRESS DOT DESIGN</b>						
SAS093	26200	1/8	Letters	3/8 x 2 3/4	3.25	227.00
SAS094	26601	1/8	Numbers	3/8 x 2 3/4	1.25	75.60
SAS095	26250	3/16	Letters	7/16 x 2 3/4	3.5	267.00
SAS096	26621	3/16	Numbers	7/16 x 2 3/4	1.38	88.90
SAS097	26300	1/4	Letters	1/2 x 3	6.00	343.00
SAS098	26641	1/4	Numbers	1/2 x 3	2.25	114.00
SAS099	26350	3/8	Letters	5/8 x 3 1/8	10.50	525.00
SAS100	26661	3/8	Numbers	5/8 x 3 1/8	3.50	175.00
SAS101	26400	1/2	Letters	3/4 x 4	18.25	799.00
SAS102	26681	1/2	Numbers	3/4 x 4	6.00	266.00

Call us for more information!



# STAMPS & STENCILS

## INDIVIDUAL STANDARD GENERAL PURPOSE STEEL HAND STAMP PIECES

- For hand-held, hammer struck applications
- Dimensions of characters in inches

Model No.	Mfg. No.	Model No.	Mfg. No.	Model No.	Mfg. No.	Model No.	Mfg. No.	Model No.	Mfg. No.	
3/32"		1/8"		3/16"		1/4"		1/2"		
<b>LETTERS</b>										
A	SF444	20150-A	SF480	20200-A	SF516	20250-A	SF552	20300-A	SF588	20400-A
B	SF445	20150-B	SF481	20200-B	SF517	20250-B	SF553	20300-B	SF589	20400-B
C	SF446	20150-C	SF482	20200-C	SF518	20250-C	SF554	20300-C	SF590	20400-C
D	SF447	20150-D	SF483	20200-D	SF519	20250-D	SF555	20300-D	SF591	20400-D
E	SF448	20150-E	SF484	20200-E	SF520	20250-E	SF556	20300-E	SF592	20400-E
F	SF449	20150-F	SF485	20200-F	SF521	20250-F	SF557	20300-F	SF593	20400-F
G	SF450	20150-G	SF486	20200-G	SF522	20250-G	SF558	20300-G	SF594	20400-G
H	SF451	20150-H	SF487	20200-H	SF523	20250-H	SF559	20300-H	SF595	20400-H
I	SF452	20150-I	SF488	20200-I	SF524	20250-I	SF560	20300-I	SF596	20400-I
J	SF453	20150-J	SF489	20200-J	SF525	20250-J	SF561	20300-J	SF597	20400-J
K	SF454	20150-K	SF490	20200-K	SF526	20250-K	SF562	20300-K	SF598	20400-K
L	SF455	20150-L	SF491	20200-L	SF527	20250-L	SF563	20300-L	SF599	20400-L
M	SF456	20150-M	SF492	20200-M	SF528	20250-M	SF564	20300-M	SF600	20400-M
N	SF457	20150-N	SF493	20200-N	SF529	20250-N	SF565	20300-N	SF601	20400-N
O	SF458	20150-O	SF494	20200-O	SF530	20250-O	SF566	20300-O	SF602	20400-O
P	SF459	20150-P	SF495	20200-P	SF531	20250-P	SF567	20300-P	SF603	20400-P
Q	SF460	20150-Q	SF496	20200-Q	SF532	20250-Q	SF568	20300-Q	SF604	20400-Q
R	SF461	20150-R	SF497	20200-R	SF533	20250-R	SF569	20300-R	SF605	20400-R
S	SF462	20150-S	SF498	20200-S	SF534	20250-S	SF570	20300-S	SF606	20400-S
<b>Price/Each</b>	<b>3.33</b>		<b>3.33</b>		<b>4.62</b>		<b>5.06</b>		<b>11.90</b>	



Model No.	Mfg. No.	Model No.	Mfg. No.	Model No.	Mfg. No.	Model No.	Mfg. No.	Model No.	Mfg. No.	
3/32"		1/8"		3/16"		1/4"		1/2"		
<b>LETTERS</b>										
T	SF463	20150-T	SF499	20200-T	SF535	20250-T	SF571	20300-T	SF607	20400-T
U	SF464	20150-U	SF500	20200-U	SF536	20250-U	SF572	20300-U	SF608	20400-U
V	SF465	20150-V	SF501	20200-V	SF537	20250-V	SF573	20300-V	SF609	20400-V
W	SF466	20150-W	SF502	20200-W	SF538	20250-X	SF574	20300-W	SF610	20400-W
X	SF467	20150-X	SF503	20200-X	SF539	20250-X	SF575	20300-X	SF611	20400-X
Y	SF468	20150-Y	SF504	20200-Y	SF540	20250-Y	SF576	20300-Y	SF612	20400-Y
Z	SF469	20150-Z	SF505	20200-Z	SF541	20250-Z	SF577	20300-Z	SF613	20400-Z
<b>Price/Each</b>	<b>3.33</b>		<b>3.33</b>		<b>4.62</b>		<b>5.06</b>		<b>11.90</b>	
<b>NUMBERS</b>										
0	SF470	20150-0	SF506	20200-0	SF542	20250-0	SF578	20300-0	SF614	20400-0
1	SF471	20150-1	SF507	20200-1	SF543	20250-1	SF579	20300-1	SF615	20400-1
2	SF472	20150-2	SF508	20200-2	SF544	20250-2	SF580	20300-2	SF616	20400-2
3	SF473	20150-3	SF509	20200-3	SF545	20250-3	SF581	20300-3	SF617	20400-3
4	SF474	20150-4	SF510	20200-4	SF546	20250-4	SF582	20300-4	SF618	20400-4
5	SF475	20150-5	SF511	20200-5	SF547	20250-5	SF583	20300-5	SF619	20400-5
6	SF476	20150-6	SF512	20200-6	SF548	20250-6	SF584	20300-6	SF620	20400-6
7	SF477	20150-7	SF513	20200-7	SF549	20250-7	SF585	20300-7	SF621	20400-7
8	SF478	20150-8	SF514	20200-8	SF550	20250-8	SF586	20300-8	SF622	20400-8
9	SF479	20150-9	SF515	20200-9	SF551	20250-9	SF587	20300-9	SF623	20400-9
<b>Price/Each</b>	<b>3.33</b>		<b>3.33</b>		<b>4.62</b>		<b>5.06</b>		<b>11.90</b>	



## STEEL TYPE & TYPE HOLDER KITS

- Save time when you mark metal
- In one stroke, a series of letters and numbers can be stamped on a product or name plate with uniform legibility
- Type holder has spring pin to hold notched type securely
- 1/8" and 3/16" holder has a 15 character capacity
- 1/4" holder handles 12 characters
- Letters, numbers, blanks must always equal full capacity of holder
- Kit contains 40 pieces: A through Z, 0 through 9, dash, and 3 blank spacers
- Packed in a sturdy wooden box with plastic insert for character storage



Model No.	Mfg. No.	Character Size"	Wt. lbs.	Price /Each
SA944	27774	1/8	3.3	944.00
SA945	27778	3/16	3.7	1009.00
SA946	27782	1/4	4.6	1131.00

Please observe the standard method of character size measurement as diagrammed below. The size chart below is based on this standard. If in doubt when re-ordering stamps, send us an impression for identification size.

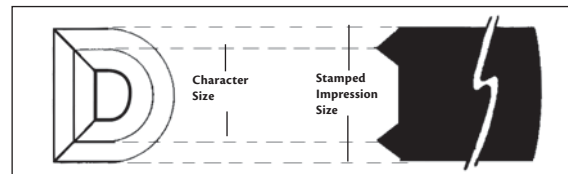
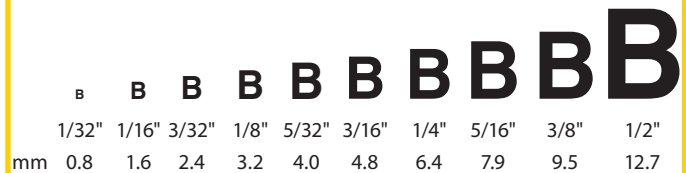



## GOTHIC BRASS INTERLOCKING STENCILS

- Durable brass for long-lasting service
- Stencils slide together and come apart easily
- Quick, legible signs on all surfaces
- Use with brush or spray ink, paint or markers
- Clean up easily with paint solvent
- Horizontal composition



## LETTERS & NUMBERS – 92-PIECE SETS

Contains: 4 E's; 3 each of A, I, N, O, S, and Spacers; 1 Q; 2 each of the remaining letters and Periods; and 1 each of Beginner, Plain Ender, Period Ender, Comma, Dash, 2 Ampersands and 1 Apostrophe.

Numbers include 3 each of 0 and 1; 2 each of 2, 3, 4, 5, 6, 7, 8 and 9.

Model No.	Mfg. No.	Character Height"	Pcs /Kit	Price /Each
SA926	10148	1	92	125.00
SA927	10151	2	92	188.00
SA928	10153	3	92	303.00
SA929	10154	4	92	444.00
SA930	10155	5	92	561.00
SA931	10156	6	92	658.00

## LETTERS & NUMBERS - 45-PIECE SETS

Contains: All 26 letters (A-Z) and numbers (0-9); and 1 each of Beginner, Plain Ender, Period Ender, Comma, Dash, Period, Ampersand and Apostrophe and 2 Spacers

Model No.	Mfg. No.	Character Height"	Pcs /Kit	Price /Each
SDN092	10068	1	45	61.90
SDN093	10071	2	45	94.50
SDN094	10073	3	45	150.00
SDN095	10074	4	45	224.00
SDN096	10075	5	45	282.00
SDN097	10076	6	45	355.00

## SINGLE LETTERS ONLY – 33-PIECE SETS

Contains: 1 each of A, B, C, D, E, F, G, H, I, J, K, L, M, N, O, P, Q, R, S, T, U, V, W, X, Y, Z, &, Beginner, Period Ender, Apostrophe, Comma, Dash, Period and Ampersand.

Model No.	Mfg. No.	Character Height"	Pcs /Kit	Price /Each
SAK464	10028	1	33	38.70
SAK465	10031	2	33	59.70
SAK466	10033	3	33	94.50
SAK467	10034	4	33	142.00
SAK468	10036	6	33	213.00
SF076	10165	8	33	1237.00
SF077	10166	10	33	1583.00
SF078	10167	12	33	1809.00

## NUMBERS ONLY – 15-PIECE SETS

Contains: 0, 0, 1, 2, 3, 4, 5, 6, 7, 8, 9 and a Beginner, Plain Ender, Dash and Period.

Model No.	Mfg. No.	Character Height"	Pcs /Kit	Price /Each
SAK469	10008	1	15	18.70
SAK470	10011	2	15	30.40
SAK471	10013	3	15	47.60
SAK472	10014	4	15	70.50
SAK473	10016	6	15	107.00
SC672*	10160	8	13	389.00
SC673*	10161	10	13	620.00
SC674*	10162	12	13	714.00

\* 13 Piece set contains one 0 only and no dash.  
Other sizes and separate letter and number sets available.  
Vertical composition also available. Please inquire.

## INDIVIDUAL LETTERS & NUMBERS

Character	Model No. 2"	Model No. 3"	Model No. 4"	Model No. 5"	Model No. 6"	Model No. 8"	Model No. 10"	Model No. 12"
<b>LETTERS</b>								
A	SF156	SF192	SF228	SF264	SF300	SF336	SF372	SF408
B	SF157	SF193	SF229	SF265	SF301	SF337	SF373	SF409
C	SF158	SF194	SF230	SF266	SF302	SF338	SF374	SF410
D	SF159	SF195	SF231	SF267	SF303	SF339	SF375	SF411
E	SF160	SF196	SF232	SF268	SF304	SF340	SF376	SF412
F	SF161	SF197	SF233	SF269	SF305	SF341	SF377	SF413
G	SF162	SF198	SF234	SF270	SF306	SF342	SF378	SF414
H	SF163	SF199	SF235	SF271	SF307	SF343	SF379	SF415
I	SF164	SF200	SF236	SF272	SF308	SF344	SF380	SF416
J	SF165	SF201	SF237	SF273	SF309	SF345	SF381	SF417
K	SF166	SF202	SF238	SF274	SF310	SF346	SF382	SF418
L	SF167	SF203	SF239	SF275	SF311	SF347	SF383	SF419
M	SF168	SF204	SF240	SF276	SF312	SF348	SF384	SF420
N	SF169	SF205	SF241	SF277	SF313	SF349	SF385	SF421
O	SF170	SF206	SF242	SF278	SF314	SF350	SF386	SF422
P	SF171	SF207	SF243	SF279	SF315	SF351	SF387	SF423
Q	SF172	SF208	SF244	SF280	SF316	SF352	SF388	SF424
R	SF173	SF209	SF245	SF281	SF317	SF353	SF389	SF425
S	SF174	SF210	SF246	SF282	SF318	SF354	SF390	SF426
T	SF175	SF211	SF247	SF283	SF319	SF355	SF391	SF427
U	SF176	SF212	SF248	SF284	SF320	SF356	SF392	SF428
V	SF177	SF213	SF249	SF285	SF321	SF357	SF393	SF429
W	SF178	SF214	SF250	SF286	SF322	SF358	SF394	SF430
X	SF179	SF215	SF251	SF287	SF323	SF359	SF395	SF431
Y	SF180	SF216	SF252	SF288	SF324	SF360	SF396	SF432
Z	SF181	SF217	SF253	SF289	SF325	SF361	SF397	SF433
<b>NUMBERS</b>								
0	SF191	SF227	SF263	SF299	SF335	SF371	SF407	SF443
1	SF182	SF218	SF254	SF290	SF326	SF362	SF398	SF434
2	SF183	SF219	SF255	SF291	SF327	SF363	SF399	SF435
3	SF184	SF220	SF256	SF292	SF328	SF364	SF400	SF436
4	SF185	SF221	SF257	SF293	SF329	SF365	SF401	SF437
5	SF186	SF222	SF258	SF294	SF330	SF366	SF402	SF438
6	SF187	SF223	SF259	SF295	SF331	SF367	SF403	SF439
7	SF188	SF224	SF260	SF296	SF332	SF368	SF404	SF440
8	SF189	SF225	SF261	SF297	SF333	SF369	SF405	SF441
9	SF190	SF226	SF262	SF298	SF334	SF370	SF406	SF442
Price/Each	2.63	3.41	5.63	7.01	8.93	49.20	69.40	89.00

# STAMPS & STENCILS

## SAFETY SIGN STENCILS

- Economical and reusable plastic stencils are pre-cut
- Use brush or spray paint to make a sign on wood, metal, paper, plastic or masonry
- Made of durable 0.015" PVC plastic
- Signs conform to OSHA regulations



HIGH VOLTAGE

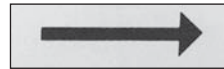

FLAMMABLE

Model No.	Mfg. No.	Description	Character Size"	Wt. lbs.	Price /Each
<b>LETTER STENCILS</b>					
SA983	12401	No Parking	2	0.8	14.00
SA986	12406	Danger	2.5	0.8	14.00
SA987	12407	Caution	2.5	0.8	14.00
SA990	12410	Flammable	2	0.8	14.00
SA991	12411	Exit	2	0.8	14.00
SA992	12412	High Voltage	2	0.8	14.00
SA993	12413	Fire Extinguisher	2	0.8	14.00
SA999	12421	Keep Aisle Clear	3	0.8	44.50
<b>SYMBOL STENCILS</b>					
SA989	12409	Arrow symbol	2 x 10	0.8	14.00
SA995	12416	Handicap symbol	15 1/2 dia.	0.35	38.70
SA996	12417	No parking symbol	15 1/2 dia.	0.35	38.70
SA997	12418	No smoking symbol	15 1/2 dia.	0.35	38.70

## PARKING LOT STENCILS

- Parking lot stencils promote safety and direct traffic
- Use on a variety of surfaces with paints formulated for parking lot use
- Precision cut to ensure high quality marking
- Lay flat for best quality painting

### COMMERCIAL GRADE

- Material - 1/8" LDPE (Low Density Polyethylene)
- Long Life - built for repetitive daily use
- Will not be damaged by paint or solvents



### ECONOMY GRADE

- 1/32" high impact polystyrene
- Same high quality construction, but thinner material is meant for occasional use
- 12" high letters



### COMMERCIAL GRADE

Model No.	Mfg. No.	Description	Character Size"	Wt. lbs.	Price /Each
<b>LETTER STENCILS</b>					
SE1879	70415	29-Pc. Alpha Kit	6 x 4	11.3	242.00
SE1880	70355	12-Pc. Number Kit	6 x 4	4.7	117.00
SE1881	70000	No Parking	4 x 3	2.3	61.90
SE1882	70418	29-Pc. Alpha Kit	12 x 9	14.0	503.00
SE1883	70358	12-Pc. Number Kit	12 x 9	6.0	184.00
SE1884	70002	No Parking	12 x 9	12.05	148.00
<b>SYMBOL STENCILS</b>					
SE1885	70471	Straight Arrow	62	18.2	209.00
SE1886	70481	Curved Arrow	62	21.8	233.00
SE1887	70343	Handicap Symbol	39	5.0	146.00

### ECONOMY GRADE

Model No.	Mfg. No.	Description	Character Size"	Wt. lbs.	Price /Each
<b>LETTER STENCILS</b>					
SB001	12430	No Parking	12	2	65.00
SB002	12431	Handicap	12	2	65.00
SB003	12432	Fire Lane	12	2	65.00
SB005	12434	Reserved	12	2	65.00
SB006	12435	Visitors	12	2	65.00
<b>SYMBOL STENCILS</b>					
SB007	12436	Straight Arrow	8 x 20	3.5	65.00
SB008	12437	Curved Arrow	8 x 27	3.5	65.00
SB009	12438	Handicap	37 x 43	3.5	68.30

## PLASTIC INTERLOCKING STENCILS

- Made of interlocking flexible PVC plastic
- Easy-to-use interlocking corners
- Clean with water or paint solvent
- More economical than brass
- Available in 46 pieces and 138 pieces

**46 pieces** includes: 2 each A, E, R, S - 1 each of remaining letters and numbers, \$, &, large and small spacers, period, and dash.

**138 pieces** includes: 3 sets of the 46-piece set.

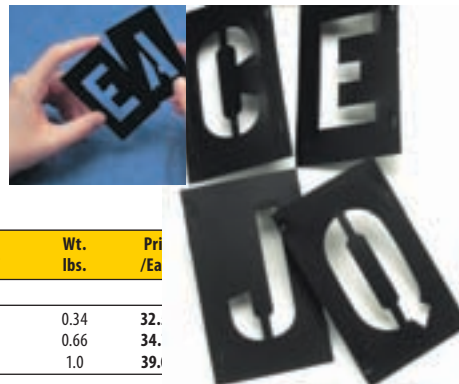

Model No.	Mfg. No.	Size"	Wt. lbs.	Price /Each	Model No.	Mfg. No.	Size"	Wt. lbs.	Price /Each
<b>46 PIECES</b>					<b>138 PIECES</b>				
SF079	10191	1	0.11	10.80	SAK461	10189	1	0.34	32.
SF080	10192	2	0.19	13.00	SAK462	10190	2	0.66	34.
SF081	10193	3	0.34	15.20	SAK463	10195	3	1.0	39.



## HAND ROLLERS & PADS

- This hand roller gives clear, distinct markings at an economical price
- Unique open cell, skinless foam roller holds more ink, gives more marks with each inking
- Protective cover included
- Choice of 1 1/2" or 3" rollers
- Stencil ink pads sold separately



Model No.	Mfg. No.	Description	Wt. lbs.	Price /Each
<b>FOUNTAIN ROLLERS</b>				
PA265	310215	1 1/2" Fountain Roller	1.0	99.20
PA266	310112	1 1/2" Replacement Roller	0.2	31.10
PA267	310230	3" Fountain Roller	1.0	99.20
PA268	310030	3" Replacement Roller	0.2	26.50
<b>HAND ROLLERS</b>				
PA262	310021	1 1/2" Hand Roller	0.3	32.50
PA260	310011	1 1/2" Replacement Roller	0.2	21.50
PA263	310023	3" Hand Roller	0.3	28.80
PA261	310013	3" Replacement Roller	0.2	19.40
PA264	310050	Ink Pad	0.2	16.10

## ROLMARK FOUNTAIN ROLLERS

- For stenciling applications on porous and non-porous surfaces
- Large ink reservoir in handle; pump action button for fast, uniform dispensing of ink
- Unique open cell, skinless foam roller for clear, solid-coverage marks
- Protective cover included
- Choice of 1 1/2" or 3" rollers

## ROLMARK INKS

- For use with fountain rollers and hand rollers
- Waterproof, permanent and fast drying
- For marking on cartons, wood boxes, metal drums, pipes and other porous and non-porous surfaces
- Comes in 1-quart cans
- Wt.: 3 lbs.



Model No.	Mfg. No.	Colour	Price /Each
PA269	310300	Black	35.00
PA270	310310	Blue	42.40
PA271	310320	Brown	74.00
PA272	310330	Green	42.90
PA274	310350	Red	42.40
PA275	310360	White	42.20
PA276	310370	Yellow	42.40
PA277	310380	Rolmark Cleaning Solvent	29.40

## STENCIL INKS

- Spray stencil ink works on almost any surface
- Available in a 12-oz. can, this spray stencil ink does not contain fluorocarbons



Model No.	Mfg. No.	Colour	Price /Each
SC668	803108	Black	8.37
SC670	803105	White	9.42
SC671	803127	Yellow	9.42

## FOUNTAIN BRUSHES

- For big stenciling jobs where speed and convenience are important factors, fountain brushes are the ideal answer
- Recommended for use with quick drying inks, comes with cover



Model No.	Description	Price /Each
SC651	Automatic Fountain Brush	90.10
SC652	Extra Tip	37.80

Ask us about volume prices!

In many cases you will benefit from quantity prices.





# STAMPS & STENCILS



## IDENTIFY LOCATIONS, SUPPLIES & TOOLS

- Mark on equipment, products, machinery, and shelves for unique identification
- Self-adhesive vinyl labels have peel-off back liner and mount to any clean, dry surface

## INDIVIDUAL LETTER & NUMBER MARKERS

Identically printed characters are ideal for multiple marking and identification.

- Markers are printed on adhesive vinyl to be self-aligning so that the characters are spaced evenly
- Printed in high-contrast black on yellow
- Choose and use only the characters you require without having to order letter and number sets
- Available per sheet

### LETTERS

	1" 10/Sheet	1 15/16" 10/Sheet	2 15/16" 6/Sheet	3 7/8" 5/Sheet
A	SC743	SC769	SR590	SC795
B	SC744	SC770	SR591	SC796
C	SC745	SC771	SR592	SC797
D	SC746	SC772	SR593	SC798
E	SC747	SC773	SR594	SC799
F	SC748	SC774	SR595	SC800
G	SC749	SC775	SR596	SC801
H	SC750	SC776	SR597	SC802
I	SC751	SC777	SR598	SC803
J	SC752	SC778	SR599	SC804
K	SC753	SC779	SR600	SC805
L	SC754	SC780	SR601	SC806
M	SC755	SC781	SR602	SC807
N	SC756	SC782	SR603	SC808
O	SC757	SC783	SR604	SC809
P	SC758	SC784	SR605	SC810
Q	SC759	SC785	SR606	SC811
R	SC760	SC786	SR607	SC812
S	SC761	SC787	SR608	SC813
T	SC762	SC788	SR609	SC814
U	SC763	SC789	SR610	SC815
V	SC764	SC790	SR611	SC816
W	SC765	SC791	SR612	SC817
X	SC766	SC792	SR613	SC818
Y	SC767	SC793	SR614	SC819
Z	SC768	SC794	SR615	SC820

Also available in other sizes and Reflective Vinyl (black on yellow only), which adds visibility, especially in low light and dark areas when directing light on it. Please call for quote.

## PRESSURE SENSITIVE NUMBERING KITS

- Pressure sensitive pre-spaced numbers are easy to align and affix to vehicle placards or for numbering ratings and specific information
- Numbers are 3 1/2" high printed black on clear Mylar™ or black on white vinyl, with permanent adhesive
- Available in a kit containing 500 numbers; 50 of each number 0 to 9
- Single numbers sold 50 per package



Model No.	Mfg. No.	Model No.	Mfg. No.	Qty /Pkg.	Price /Each
SA0097	UNCLKIT	SA0098	UNWHKIT	500	202.00

Character height: 1"  
10 characters per sheet  
Marker size: 1 1/2" H x 7/8" W



Character height: 1 15/16"  
10 characters per sheet  
Marker size: 2 1/4" H x 7/8" W



Character height: 2 15/16"  
6 characters per sheet  
Marker size: 3 1/2" H x 1 1/2" W



Character height: 3 7/8"  
5 characters per sheet  
Marker size: 5" H x 1 3/4" W



Character Height"	Character Per Sheet	Price /Sheet
1	10	5.16
1 15/16	10	6.12
2 15/16	6	6.95
3 7/8	5	10.50

### NUMBERS

	1" 10/Sheet	1 15/16" 10/Sheet	2 15/16" 6/Sheet	3 7/8" 5/Sheet
0	SC821	SC831	SE822	SC841
1	SC822	SC832	SE823	SC842
2	SC823	SC833	SE824	SC843
3	SC824	SC834	SE825	SC844
4	SC825	SC835	SE826	SC845
5	SC826	SC836	SE827	SC846
6	SC827	SC837	SE828	SC847
7	SC828	SC838	SE829	SC848
8	SC829	SC839	SE830	SC849
9	SC830	SC840	SE831	SC850



## MATERIALS

Our comprehensive selection of custom sign materials are designed to meet virtually every application and environmental demand.

Customize the size and materials to fit your need, and add your company logo for added personalization!



### ADHESIVE VINYL:

Self stick sign is for indoor or sheltered areas. Adhere to most flat, clean, dry surfaces. Ideal for basic identification purposes or short term outdoor applications.

- Flexible 4-mil thick vinyl with acrylic adhesive
- Non-glare printed surface
- Impact resistant
- Moisture resistant

### PLASTIC:

Semi-flexible thick plastic sign for standard, medium-duty use. Use long-term indoor and sheltered outdoor locations – or temporary outdoor exposure, such as construction sites.

- 0.055" thick polyethylene plastic
- Non glare finish
- 3/16" mounting holes with rounded corners

### ALUMINUM:

Provides the strength of metal, yet does not rust. Printed image is UV protected by 2-mil, high-gloss polyester overlamine to resist fading. Ideal choice for indoor and outdoor use where a metal sign is required.

- 0.040" thick aluminum
- Withstands washdowns, harsh environments and is abrasion, chemical, and impact resistant.
- Durability warranty to 5 years
- 3/16" mounting holes with rounded corners



### ACCU-SHIELD™:

Highest performance sign with superior construction for extreme conditions - outstanding UV protection, high impact strength, tough under harsh conditions such as chemicals, corrosion, and abrasions, and nearly indestructible to vandalism. Reverse printed image on the underside of the thick face and further protected underneath. Rugged appearance with a thick-edge design and pebble-textured backside.

- 0.152" thick specially-formulated polycarbonate and poly bonded back
- Durability warranty to 15 years
- 1/4" mounting holes with rounded corners



### ADHESIVE DURA-VINYL™:

Dual-layered vinyl that outperforms standard vinyl. Printed image is protected by a high-gloss 2-mil UV resistant polyester over laminate to prevent fading for outdoor use.

- Flexible 6-mil thick poly-composite
- Durability warranty to 5 years
- Abrasion, humidity, chemical, and solvent resistant
- Adheres to smooth, curved and irregular surfaces



### DURA-PLASTIC™:

Polycarbonate plastic offers high impact resistance and durability for outdoor applications and harsh environments. Printed image is protected by 2-mil, high-gloss polyester overlamine with UV resistance to fading.

- 0.060" thick polycarbonate
- Resistant to abrasion, humidity, and chemicals
- Durability warranty to 7 years
- 3/16" mounting holes with rounded corners



### DURA-ALUMALITE™:

High strength, yet lightweight composite aluminum sign. 40% lighter than same thick solid aluminum, yet the same durability, stiffness and rigidity. UV protected by 2-mil, high-gloss polyester overlamine to resist fading and abrasions.

- 0.118" thick - aluminum sheets bonded to both sides of thermoplastic core
- Extremely durable for tough indoor and outdoor conditions from high impacts to vandalism
- Durability warranty to 10 years
- 1/4" mounting holes with rounded corners



# SAFETY SIGNS & IDENTIFICATION



## ACCIDENT PREVENTION SIGNS

The Occupational Safety and Health Administration (OSHA 29 CFR§ 1910.145) provides specifications, design, application and use of header signs. These signs are intended to indicate potential, type and degree of the hazard that may lead to accidental injury or property damage. They define specific hazards by conveying a clear and rapidly understood message.

### ACCIDENT PREVENTION HEADERS



**DANGER** — Indicates an imminently hazardous situation which, if not avoided, will result in death or serious injury. This signal word is to be limited to the most extreme situations. The signal word Danger should not be used for property damage hazards unless personal injury risk appropriate to the level is also involved.

**WARNING** — Indicates a potentially hazardous situation which, if not avoided, could result in death or serious injury. This signal word should not be used for property damage hazards unless personal injury risk appropriate to this level is also involved.

**CAUTION** — Indicates a potentially hazardous situation which, if not avoided, may result in minor or moderate injury. It may also be used to alert against unsafe practices that may cause property damage.

**NOTICE** — Indicates a statement of company policy directly or indirectly related to the safety of personnel or protection of property. This signal word should not be associated directly with a hazard or hazardous situation.

**SAFETY FIRST, THINK, EMERGENCY** — Indicates general instructions relative to safe work practices, reminds of proper safety procedures and indicates the location of safety equipment.

### ACCIDENT PREVENTION SIGN CONTENTS



#### Header

A specific or "signal" word (or words) to designate a degree or level of safety alerting, always located in the uppermost portion of the sign. Intended to capture and direct attention to the potential hazardous situation.

#### Legend

The specific short message conveys the need to pay attention to a potential hazard or hazards, or take a necessary action to avoid such hazard(s).



Many signs consist of just header and legend — Signs can also contain a symbol...

#### Symbol

Pictorials are graphic representations to clearly convey a specific alerting message compatible with and supplemental to the legend message. Universal in design, many are standardized to be easily understood.

### MATERIALS

#### ADHESIVE VINYL (VS)

For light-duty applications. The ideal choice for indoor and sheltered outdoor marking needs. Mounts to all curved areas such as pipes, poles and secondary containers.

- 4-mil thick surface printed matte surface
- Permanent acrylic adhesive
- Moisture-resistant
- Service temperature range: -20°F to 140°F
- Durability: 2 years outdoors
- Square corners and scored backing for quick peel-off and application

#### PLASTIC (VP)

Semi-flexible, economical and appropriate for medium-duty use - ideal for indoor and sheltered outdoor environments.

- Ideal for flat surfaces with enough flex to mount on slightly curved areas
- 0.055" thick with good impact resistance and surface image with non-glare finish
- Contains UV inhibitors
- Service temperature range: -90°F to 168°F
- Durability: 2 years outdoors
- Rounded corners and 3/16" mounting holes

#### ALUMINUM (VA)

Get the strength of metal, without the rust. Superior abrasion and chemical resistance for indoor and outdoor environments.

- Printed image on rigid 0.040" aluminum backing
- Protected by 2-mil high-gloss UV polyester over-laminate film
- Service temperature range: -20°F to 140°F
- Withstands splashes and washdowns
- Endures outdoor environmental conditions
- Durability: 5 years outdoors
- Rounded corners and 3/16" mounting holes



# SAFETY SIGNS & IDENTIFICATION

## ENGLISH ADMITTANCE & EXIT



Mat'l	7" x 10"	10" x 14"
VS	SAS590	SAS593
VP	SAS591	SAS594
VA	SAS592	SAS595



7" x 10"	10" x 14"
SAS596	SAS599
SAS597	SAS600
SAS598	SAS601



7" x 10"	10" x 14"
SJ512	SJ513
SJ510	SJ511
SJ508	SJ509



7" x 10"	10" x 14"
SJ519	SJ520
SJ517	SJ518
SJ515	SJ516



7" x 10"	10" x 14"
SAS608	SAS611
SAS609	SAS612
SAS610	SAS613



7" x 10"	10" x 14"
SAP697	SAP698
SAP695	SAP696
SAP693	SAP694



Mat'l	7" x 10"	10" x 14"
VS	SS327	SS896
VP	ST371	SU607
VA	SU091	SV657



7" x 10"	10" x 14"
SAS614	SAS617
SAS615	SAS618
SAS616	SAS619



7" x 10"	10" x 14"
SS675	ST291
ST814	SV082
SU502	SW125



7" x 10"	10" x 14"
SAS620	SAS623
SAS621	SAS624
SAS622	SAS625



7" x 10"	10" x 14"
SS665	ST281
ST804	SV072
SU493	SW116



7" x 10"	10" x 14"
SJ437	SJ438
SJ435	SJ436
SJ433	SJ434



Mat'l	7" x 10"	10" x 14"
VS	SAS656	SAS659
VP	SAS657	SAS660
VA	SAS658	SAS661



7" x 10"	10" x 14"
SAP737	SAP738
SAP736	SJ725
SAP735	SJ724



7" x 10"	10" x 14"
SJ722	SJ723
SJ720	SJ721
SJ718	SJ719



7" x 10"	10" x 14"
SAS722	SAS725
SAS723	SAS726
SAS724	SAS727



7" x 10"	10" x 14"
SJ732	SJ733
SJ730	SJ731
SJ728	SJ729



7" x 10"	10" x 14"
SAS680	SAS683
SAS681	SAS684
SAS682	SAS685



Mat'l	7" x 10"	10" x 14"
VS	SAS692	SAS695
VP	SAS693	SAS696
VA	SAS694	SAS697



7" x 10"	10" x 14"
SJ760	SJ767
SJ758	SJ759
SJ756	SJ757



7" x 10"	10" x 14"
SJ805	SJ806
SJ803	SJ804
SJ801	SJ802



7" x 10"	10" x 14"
SJ811	SJ812
SJ809	SJ810
SJ807	SJ808



7" x 10"	10" x 14"
SAS728	SAS731
SAS729	SAS732
SAS730	SAS733



7" x 10"	10" x 14"
SJ852	SJ853
SJ850	SJ851
SJ848	SJ849



Mat'l	7" x 10"	10" x 14"
VS	SJ878	SJ879
VP	SJ876	SJ877
VA	SJ874	SJ875



7" x 10"	10" x 14"
SAS740	SAS743
SAS741	SAS744
SAS742	SAS745



7" x 10"	10" x 14"
SAS797	SAS800
SAS798	SAS801
SAS799	SAS802



7" x 10"	10" x 14"
SAS776	SAS791
SAS777	SAS792
SAS778	SAS793



7" x 10"	10" x 14"
SS607	ST223
ST757	SV008
SU448	SW052



7" x 10"	10" x 14"
SAS632	SAS635
SAS633	SAS636
SAS634	SAS637



Mat'l	7" x 10"	10" x 14"
VS	SAS644	SAS647
VP	SAS645	SAS648
VA	SAS646	SAS649

Price/Each

Material Code	Material	7" x 10"	10" x 14"
VS	Adhesive Vinyl	13.20	19.80
VP	Plastic	14.40	21.50
VA	Aluminum	20.50	34.10



**ACCUFORM**

IF YOU DO NOT SEE THE LEGEND OR SIZE YOU ARE LOOKING FOR PLEASE CALL US!

OFFICE PRODUCTS

INSTRUMENTS, SCALES & ELECTRICAL

SHIPPING & PACKAGING

TOOLS & EQUIPMENT

WELDING & METALWORKING

SAFETY EQUIPMENT & SUPPLIES

JANITORIAL & MAINTENANCE

MATERIAL HANDLING & STORAGE

# SAFETY SIGNS & IDENTIFICATION



## ENGLISH CHEMICALS & HAZ-MAT

Mat'l	7" x 10"    10" x 14"	7" x 10"    10" x 14"	7" x 10"    10" x 14"	7" x 10"    10" x 14"	7" x 10"    10" x 14"	7" x 10"    10" x 14"
VS	SAT225    SAT226	SK174    SK175	SK216    SK217	SAT249    SAT250	SK368    SK369	SK375    SK376
VP	SAT223    SAT224	SK172    SK173	SK214    SK215	SAT247    SAT248	SK366    SK367	SK373    SK374
VA	SAT221    SAT222	SK170    SK171	SK212    SK213	SAT245    SAT246	SK364    SK365	SK371    SK372

Mat'l	7" x 10"    10" x 14"	7" x 10"    10" x 14"	7" x 10"    10" x 14"	7" x 10"    10" x 14"	7" x 10"    10" x 14"	7" x 10"    10" x 14"
VS	SAT339    SAT340	SAT345    SAT346	SAT369    SAT370	SK276    SK277	SAT375    SAT376	SEJ200    SEJ203
VP	SAT337    SAT338	SAT343    SAT344	SAT367    SAT368	SK274    SK275	SAT373    SAT374	SEJ201    SEJ204
VA	SAT335    SAT336	SAT341    SAT342	SAT365    SAT366	SK272    SK273	SAT371    SAT372	SEJ202    SBC444

Mat'l	7" x 10"    10" x 14"	7" x 10"    10" x 14"	7" x 10"    10" x 14"	7" x 10"    10" x 14"	7" x 10"    10" x 14"
VS	SAT405    SAT406	SAT429    SAT430	SBB083    SEJ206	SAT489    SAT490	SK557    SK558
VP	SAT403    SAT404	SAT427    SAT428	SEJ205    SEJ207	SAT487    SAT488	SK555    SK556
VA	SAT401    SAT402	SAT425    SAT426	SBB082    SEJ208	SAT486    SAD049	SK553    SK554

## ENGLISH CONFINED SPACE

Mat'l	7" x 10"    10" x 14"	7" x 10"    10" x 14"	7" x 10"    10" x 14"	7" x 10"    10" x 14"	7" x 10"    10" x 14"	7" x 10"    10" x 14"
VS	SAT505    SAT506	SBC569    SBC575	SAT535    SAT536	SAT541    SAT542	SAT571    SAT572	SAT517    SAT518
VP	SAT503    SAT504	SBC568    SBC574	SAT533    SAT534	SAT539    SAT540	SAT569    SAT570	SAT515    SAT516
VA	SAT501    SAT502	SBC567    SBC573	SAT531    SAT532	SAT537    SAT538	SAT567    SAT568	SAT513    SAT514

## ENGLISH ELECTRICAL

Mat'l	7" x 10"    10" x 14"	7" x 10"    10" x 14"	7" x 10"    10" x 14"	7" x 10"    10" x 14"	7" x 10"    10" x 14"	7" x 10"    10" x 14"
VS	SAT008    SAT011	SJ562    SJ563	SL115    SL116	SAT705    SAT708	SAT711    SAP725	SAT720    SAT723
VP	SAT009    SAT158	SBC648    SJ561	SL113    SL114	SAT706    SAT709	SAT712    SL118	SAT721    SAT724
VA	SAT010    SAT159	SJ558    SJ559	SL111    SL112	SAT707    SAT710	SAT713    SL117	SAT722    SAT725

Price/Each

Material Code	Material	7" x 10"	10" x 14"
VS	Adhesive Vinyl	13.20	19.80
VP	Plastic	14.40	21.50
VA	Aluminum	20.50	34.10



IF YOU DO NOT SEE THE LEGEND OR SIZE YOU ARE LOOKING FOR PLEASE CALL US!

# SAFETY SIGNS & IDENTIFICATION

## ENGLISH ELECTRICAL CONT'D



Mat'l	7" x 10"	10" x 14"
VS	SJ597	SJ598
VP	SJ595	SJ596
VA	SJ593	SJ594



7" x 10"	10" x 14"
SAT915	SAT918
SAT916	SAT919
SAT917	SAT920



7" x 10"	10" x 14"
SAT921	SAT924
SAT922	SAT925
SAT923	SAT926



7" x 10"	10" x 14"
SAT669	SAT672
SAT670	SAT673
SAT671	SAT674



7" x 10"	10" x 14"
SAT939	SAT942
SAT940	SAT943
SAT941	SAT944



7" x 10"	10" x 14"
SAT675	SAT678
SAT676	SAT679
SAT677	SAT680



Mat'l	7" x 10"	10" x 14"
VS	SEJ209	SEJ212
VP	SEJ210	SEJ213
VA	SEJ211	SEJ214



7" x 10"	10" x 14"
SAT975	SAT978
SAT976	SAT979
SAT977	SAT980



7" x 10"	10" x 14"
SAT969	SAT972
SAT970	SAT973
SAT971	SAT974



7" x 10"	10" x 14"
SAT993	SAT996
SAT994	SAT997
SAT995	SAT998



7" x 10"	10" x 14"
SAU012	SAU015
SAU013	SAU016
SAU014	SAU017



7" x 10"	10" x 14"
SS401	SAU031
SAU029	SAU032
SAU030	SAU033



Mat'l	7" x 10"	10" x 14"
VS	SAU058	SAU061
VP	SAU059	SAU062
VA	SAU060	SAU063



7" x 10"	10" x 14"
SAU023	SAU026
SAU024	SAU027
SAU025	SAU028



7" x 10"	10" x 14"
SAU086	SAU089
SAU087	SAU090
SAU088	SAU091



7" x 10"	10" x 14"
SAT754	SAT757
SAT755	SAT758
SAT756	SAT759



10" x 7"	14" x 10"
SAT760	SAT763
SAT761	SAT764
SAT762	SAT765



7" x 10"	10" x 14"
SAT795	SAT798
SAT796	SAT799
SAT797	SAT800

## ENGLISH FIRST AID



Mat'l	7" x 10"	10" x 14"
VS	SAU127	SAU130
VP	SAU128	SAU131
VA	SAU129	SAU132



7" x 10"	10" x 14"
SEJ223	SEJ226
SEJ224	SEJ227
SEJ225	SEJ228



18" x 4"	17" x 7"
SBC835	SEJ229
SBC834	SBC829
SEJ222	SEJ230



7" x 10"	10" x 14"
SAU145	SAU148
SAU146	SAU149
SAU147	SAU150



7" x 10"	10" x 14"
SAU163	SAU166
SAU164	SAU167
SAU165	SAU168



7" x 10"	10" x 14"
SAU169	SAU172
SAU170	SAU173
SAU171	SAU174



Mat'l	7" x 10"	10" x 14"
VS	SAU181	SAU184
VP	SAU182	SAU185
VA	SAU183	SAU186



7" x 10"	10" x 14"
SL809	SL810
SL808	SAU199
SL807	SAU200



7" x 10"	10" x 14"
SAU201	SAU204
SAU202	SAU205
SAU203	SAU206



7" x 10"	10" x 14"
SAU207	SAU210
SAU208	SAU211
SAU209	SAU212



10" x 7"	14" x 10"
SAU213	SAU216
SAU214	SAU217
SAU215	SAU218



7" x 10"	10" x 14"
SAU219	SAU222
SAU220	SAU223
SAU221	SAU224



Mat'l	10" x 7"	14" x 10"
VS	SDN994	SBC850
VP	SDN945	SBC849
VA	SDN946	SDN887



10" x 7"	14" x 10"
SDN908	SBC848
SDN909	SBC847
SDN910	SDN911



10" x 7"	14" x 10"
SDN924	SDN927
SDN925	SDN928
SDN926	SDN929

Price/Each

Material Code	Material	18" x 4"	17" x 7"	7" x 10"	10" x 14"
VS	Adhesive Vinyl	13.20	19.80	13.20	19.80
VP	Plastic	14.40	21.50	14.40	21.50
VA	Aluminum	20.50	34.10	20.50	34.10

IF YOU DO NOT SEE THE LEGEND OR SIZE YOU ARE LOOKING FOR PLEASE CALL US!



ACCUFORM®

OFFICE PRODUCTS

INSTRUMENTS, SCALES & ELECTRICAL

SHIPPING & PACKAGING

TOOLS & EQUIPMENT

WELDING & METALWORKING

SAFETY EQUIPMENT & SUPPLIES

JANITORIAL & MAINTENANCE

MATERIAL HANDLING & STORAGE

# SAFETY SIGNS & IDENTIFICATION



## ENGLISH PERSONAL PROTECTION



Mat'l	7" x 10"	10" x 14"
VS	SAU368	SAU371
VP	SAU369	SM254
VA	SAU370	SM253



7" x 10"	10" x 14"
SAU372	SAU375
SAU373	SAU376
SAU374	SAU377



7" x 10"	10" x 14"
SAU384	SAU387
SAU385	SAU388
SAU386	SAU389



7" x 10"	10" x 14"
SAU402	SAU405
SAU403	SAU406
SAU404	SAU407



7" x 10"	10" x 14"
SAU414	SAU417
SAU415	SAU418
SAU416	SAU419



7" x 10"	10" x 14"
SM340	SM341
SM338	SM339
SM336	SM337



Mat'l	7" x 10"	10" x 14"
VS	SM068	SM069
VP	SM066	SM067
VA	SM064	SM065



7" x 10"	10" x 14"
SAU447	SAU450
SAU448	SAU451
SAU449	SAU452



7" x 10"	10" x 14"
SAU458	SAU461
SAU459	SAU462
SAU460	SAU463



7" x 10"	10" x 14"
SK764	SK765
SK762	SK763
SK760	SK761



7" x 10"	10" x 14"
SAU464	SAU467
SAU465	SM282
SAU466	SM281



7" x 10"	10" x 14"
SAU534	SAU537
SAU535	SAU538
SAU536	SAU539



Mat'l	7" x 10"	10" x 14"
VS	SK791	SK792
VP	SK789	SK790
VA	SK787	SK788



7" x 10"	10" x 14"
SAU506	SAU509
SAU507	SM245
SAU508	SM244



7" x 10"	10" x 14"
SAU522	SAU525
SAU523	SAU526
SAU524	SAU527



7" x 10"	10" x 14"
SAU540	SAU543
SAU541	SAU544
SAU542	SAU545



7" x 10"	10" x 14"
SAU546	SAU549
SAU547	SAU550
SAU548	SAU551



7" x 10"	10" x 14"
SM295	SM296
SM293	SM294
SM291	SM292

## ENGLISH SMOKING CONTROL



Mat'l	7" x 10"	10" x 14"
VS	SEJ236	SBD156
VP	SEJ237	SBD155
VA	SEJ238	SBD154



7" x 10"	10" x 14"
SM355	SM356
SM353	SM354
SM351	SM352



7" x 10"	10" x 14"
SL892	SL893
SL890	SL891
SL888	SL889



7" x 10"	10" x 14"
SAS911	SAS917
SAS912	SL895
SAS913	SL894



7" x 10"	10" x 14"
SAS971	SAS974
SAS972	SAS975
SAS973	SAS976



7" x 10"	10" x 14"
SL956	SL957
SL955	SAS918
SL954	SAS919

## ENGLISH SAFETY INCENTIVE



Mat'l	7" x 10"	10" x 14"
VS	SAS905	SAS908
VP	SAS906	SAS909
VA	SAS907	SAS910



7" x 10"	10" x 14"
SAS983	SAS914
SAS984	SAS915
SAS985	SAS916



7" x 10"	10" x 14"
SAS986	SAS920
SAS987	SAS921
SAS988	SAS922



ACCUFORM®

Price/Each

Material Code	Material	7" x 10"	10" x 14"
VS	Adhesive Vinyl	13.20	19.80
VP	Plastic	14.40	21.50
VA	Aluminum	20.50	34.10

IF YOU DO NOT SEE THE LEGEND OR SIZE YOU ARE LOOKING FOR PLEASE CALL US!



# SAFETY SIGNS & IDENTIFICATION

## ENGLISH SMOKING CONTROL CONT'D



Mat'l	7" x 10"	10" x 14"
VS	SAS989	SAS992
VP	SAS990	SAS993
VA	SAS991	SAS994



7" x 10"	10" x 14"
SL969	SL970
SL967	SL968
SL965	SL966



7" x 10"	10" x 14"
SAT020	SAT023
SL691	SAT024
SL690	SAT025



7" x 10"	10" x 14"
SAT014	SAT017
SAT015	SAT018
SAT016	SAT019



10" x 7"	14" x 10"
SL981	SL982
SL979	SL980
SL977	SL978



7" x 10"	10" x 14"
SAT026	SAT029
SAT027	SAT030
SAT028	SAT031

## ENGLISH TRAFFIC INDUSTRIAL



Mat'l	7" x 10"	10" x 14"
VS	SAT038	SAT041
VP	SAT039	SAT042
VA	SAT040	SAT043



7" x 10"	10" x 14"
SAT044	SAT047
SL973	SAT048
SL972	SAT049



7" x 10"	10" x 14"
SAT050	SAT053
SAT051	SAT054
SAT052	SAT055



7" x 10"	10" x 14"
SAT062	SAT065
SAT063	SAT066
SAT064	SAT067



7" x 10"	10" x 14"
SAT068	SAT071
SAT069	SAT072
SAT070	SAT073



7" x 10"	10" x 14"
SAT074	SAT077
SAT075	SAT078
SAT076	SAT079



Mat'l	7" x 10"	10" x 14"
VS	SAT092	SAT095
VP	SAT093	SAT096
VA	SAT094	SAT097



7" x 10"	10" x 14"
SAT104	SAT107
SAT105	SAT108
SAT106	SAT109



7" x 10"	10" x 14"
SAT110	SAT113
SAT111	SAT114
SAT112	SAT115



7" x 10"	10" x 14"
SAT116	SAT119
SAT117	SAT120
SAT118	SAT121



7" x 10"	10" x 14"
SAT122	SAT125
SAT123	SAT126
SAT124	SAT127



7" x 10"	10" x 14"
SAT128	SAT131
SAT129	SAT132
SAT130	SAT133

## ENGLISH FIRE & EMERGENCY EXITS



Mat'l	7" x 10"	10" x 14"
VS	SAT134	SAT137
VP	SAT135	SAT138
VA	SAT136	SAT139



7" x 10"	10" x 14"
SAT140	SAT143
SAT141	SAT144
SAT142	SAT145



7" x 10"	10" x 14"
SL037	SL038
SL035	SL036
SL033	SL034



7" x 10"	10" x 14"
SL022	SL023
SL021	SA5786
SL020	SA5787



7" x 10"	10" x 14"
SK986	SAT821
SAT819	SK985
SAT820	SK984



7" x 10"	10" x 14"
SK992	SK993
SK990	SK991
SK988	SK989



Mat'l	7" x 10"	10" x 14"
VS	SL005	SL006
VP	SL002	SL003
VA	SK999	SL001



7" x 10"	10" x 14"
SAT828	SAT831
SAT829	SAT832
SAT830	SAT833



7" x 10"	10" x 14"
SEJ216	SEJ219
SEJ217	SEJ220
SEJ218	SEJ221



7" x 10"	10" x 14"
SAT822	SAT825
SAT823	SAT826
SAT824	SAT827



7" x 10"	10" x 14"
SAT840	SAT843
SAT841	SAT844
SAT842	SAT845



7" x 10"	10" x 14"
SL569	SL570
SAT846	SAT848
SAT847	SAT849



Mat'l	7" x 10"	10" x 14"
VS	SAT905	SAT906
VP	SL626	SAT907
VA	SL625	SAT908



10" x 7"	14" x 10"
SAU105	SAU108
SAU106	SAU109
SAU107	SAU110



10" x 7"	14" x 10"
SAT886	SAT889
SAT887	SAT890
SAT888	SAT891



10" x 7"	14" x 10"
SAT892	SAP765
SAT893	SL597
SAT894	SL596



10" x 7"	14" x 10"
SAT895	SAT898
SAT896	SAT899
SAT897	SAT900



7" x 10"	10" x 14"
SAT901	SAT904
SAT902	SL608
SAT903	SL607



Mat'l	12" x 4"	18" x 4"
VS	SAZ778	SBC912
VP	SBC907	SBC911
VA	SBA013	SAT885

18" x 4"
SBC935
SBC934
SEJ215

IF YOU DO NOT SEE THE LEGEND OR SIZE YOU ARE LOOKING FOR PLEASE CALL US!

Price/Each

Material Code	Material	12" x 4"	18" x 4"	7" x 10"	10" x 14"
VS	Adhesive Vinyl	9.55	13.20	13.20	19.80
VP	Plastic	10.80	14.40	14.40	21.50
VA	Aluminum	13.10	34.10	20.50	34.10



ACCUFORM®

# SAFETY SIGNS & IDENTIFICATION



## FRENCH ADMITTANCE



Mat'l	7" x 10"	10" x 14"
VS	SAZ545	SAZ546
VP	S0179	S0180
VA	S0177	S0178



7" x 10"	10" x 14"
S0124	S0125
S0122	SAZ541
S0120	S0121



7" x 10"	10" x 14"
S0139	S0140
S0137	S0138
SAZ543	SAZ544



7" x 10"	10" x 14"
S0174	S0175
S0172	S0173
S0170	S0171



7" x 10"	10" x 14"
S0188	S0189
S0186	S0187
S0184	S0185



7" x 10"	10" x 14"
S0222	S0223
S0220	S0221
S0218	S0219



Mat'l	7" x 10"	10" x 14"
VS	S0161	S0162
VP	S0159	S0160
VA	S0157	S0158



7" x 10"	10" x 14"
SED665	SEF986
SEF983	SEF985
SEF982	SEF984



7" x 10"	10" x 14"
S0196	S0197
S0194	S0195
S0192	S0193



7" x 10"	10" x 14"
S0393	S0394
S0391	S0392
S0389	S0390



7" x 10"	10" x 14"
S0479	S0480
S0477	S0478
SAZ563	SAZ564



7" x 10"	10" x 14"
S0535	S0536
S0533	S0534
SAZ565	S0532



Mat'l	7" x 10"	10" x 14"
VS	SEJ239	SEB929
VP	SEJ240	SEJ243
VA	SEJ241	SEJ244



7" x 10"	10" x 14"
S0493	S0494
S0491	S0492
S0489	S0490



7" x 10"	10" x 14"
S0430	S0431
S0428	S0429
S0426	S0427



7" x 10"	10" x 14"
SP066	SP067
SP064	SP065
SAZ607	SP063



7" x 10"	10" x 14"
S0621	S0622
S0619	S0620
S0617	S0618



7" x 10"	10" x 14"
S0300	S0301
S0298	SAZ554
S0296	S0297

## FRENCH CONFINED SPACE



Mat'l	7" x 10"	10" x 14"
VS	S0132	S0133
VP	S0130	S0131
VA	SAZ542	S0129



7" x 10"	10" x 14"
S0244	S0245
S0242	S0243
S0240	S0241



7" x 10"	10" x 14"
S0258	S0259
S0256	S0257
S0254	S0255



7" x 10"	10" x 14"
SEG163	SEG142
SEG162	SEG141
SEG161	SEG140



7" x 10"	10" x 14"
S0842	S0843
S0840	S0841
S0838	S0839



7" x 10"	10" x 14"
S0117	S0118
S0115	S0116
S0113	S0114



Mat'l	7" x 10"	10" x 14"
VS	S0878	S0879
VP	S0876	S0877
VA	S0874	SAZ577



7" x 10"	10" x 14"
S0790	S0791
S0788	S0789
S0786	S0787



10" x 7"	14" x 10"
S0797	S0798
S0795	S0796
SAZ569	SAZ570



7" x 10"	10" x 14"
S0229	S0230
S0227	S0228
S0225	S0226



7" x 10"	10" x 14"
S0835	S0836
S0833	S0834
S0831	S0832



7" x 10"	10" x 14"
S0870	S0871
S0869	SAZ576
S0868	SAZ575

Price/Each

Material Code	Material	7" x 10"	10" x 14"
VS	Adhesive Vinyl	13.20	19.80
VP	Plastic	14.40	21.50
VA	Aluminum	20.50	34.10



ACCUFORM

IF YOU DO NOT SEE THE LEGEND OR SIZE YOU ARE LOOKING FOR PLEASE CALL US!

# SAFETY SIGNS & IDENTIFICATION

## FRENCH EQUIPMENT

Mat'l	7" x 10" 10" x 14"	7" x 10" 10" x 14"	7" x 10" 10" x 14"	7" x 10" 10" x 14"	7" x 10" 10" x 14"	7" x 10" 10" x 14"
VS	SP526 SP527	SP259 SP260	SP575 SP576	SP164 SP165	SP171 SP172	SP596 SP597
VP	SP524 SP525	SP257 SP258	SP573 SP574	SP162 SP163	SP169 SP170	SP594 SP595
VA	SP522 SP523	SP255 SP256	SP571 SP572	SP160 SP161	SP167 SP168	SP592 SP593

## FRENCH FIRST AID

Mat'l	10" x 7" 14" x 10"	7" x 10" 10" x 14"	7" x 10" 10" x 14"	7" x 10" 10" x 14"	7" x 10" 10" x 14"	7" x 10" 10" x 14"
VS	SP483 SP484	SP468 SP469	SP437 SP438	SP603 SP604	SAZ653 SAZ654	SAZ649 SAZ650
VP	SP481 SP482	SAZ642 SAZ643	SP435 SP436	SP601 SP602	SP655 SAZ652	SP637 SAZ648
VA	SAZ644 SP480	SAZ640 SAZ641	SP433 SP434	SP599 SP600	SP654 SAZ651	SP636 SAZ647
Mat'l	7" x 10" 10" x 14"	7" x 10" 10" x 14"	10" x 7" 14" x 10"	10" x 7" 14" x 10"	10" x 7" 14" x 10"	
VS	SAZ657 SAZ658	SAZ657 SAZ658	SDN891 SDN894	SDN915 SDN918	SDN933 SDN936	
VP	SP659 SAZ656	SP659 SAZ656	SDN892 SDN895	SDN916 SDN919	SDN934 SDN937	
VA	SP658 SAZ655	SP658 SAZ655	SDN893 SDN896	SDN917 SDN920	SDN935 SDN938	

## FRENCH HOUSEKEEPING & HYGIENE

Mat'l	7" x 10" 10" x 14"	7" x 10" 10" x 14"	7" x 10" 10" x 14"	7" x 10" 10" x 14"	7" x 10" 10" x 14"	7" x 10" 10" x 14"
VS	SP744 SP745	SP730 SP731	SP764 SP765	SP823 SP824	SP791 SAZ673	SP815 SP816
VP	SP742 SP743	SP728 SP729	SP762 SP763	SP821 SP822	SP789 SP790	SP813 SP814
VA	SP740 SP741	SP726 SP727	SAZ670 SP761	SP819 SP820	SAZ671 SAZ672	SAZ676 SAZ677

## FRENCH PERSONAL PROTECTION

Mat'l	7" x 10" 10" x 14"	7" x 10" 10" x 14"	7" x 10" 10" x 14"	7" x 10" 10" x 14"	7" x 10" 10" x 14"	7" x 10" 10" x 14"
VS	S0719 S0720	S0110 S0111	S0277 S0278	S0293 S0294	S0285 S0286	S0356 S0357
VP	S0717 S0718	S0108 S0109	S0275 S0276	S0291 S0292	S0283 S0284	S0354 S0355
VA	S0715 S0716	S0106 S0107	S0273 S0274	S0289 S0290	S0281 S0282	S0352 S0353

## FRENCH SAFETY INCENTIVE

Mat'l	7" x 10" 10" x 14"	7" x 10" 10" x 14"	7" x 10" 10" x 14"	7" x 10" 10" x 14"	7" x 10" 10" x 14"
VS	S0264 S0265	S0683 S0684	S0754 S0755	S0662 S0663	SEG468 SEG955
VP	SAZ551 S0263	S0681 S0682	S0752 S0753	S0660 S0661	SEG467 SEG956
VA	SAZ549 SAZ550	S0679 S0680	S0750 S0751	S0658 S0659	SEG466 SEG957

Price/Each

Material Code	Material	7" x 10"	10" x 14"
VS	Adhesive Vinyl	13.20	19.80
VP	Plastic	14.40	21.50
VA	Aluminum	20.50	34.10

IF YOU DO NOT SEE THE LEGEND OR SIZE YOU ARE LOOKING FOR PLEASE CALL US!



ACCUFORM®

OFFICE PRODUCTS

INSTRUMENTS, SCALES & ELECTRICAL

SHIPPING & PACKAGING

TOOLS & EQUIPMENT

WELDING & METALWORKING

SAFETY EQUIPMENT & SUPPLIES

JANITORIAL & MAINTENANCE

MATERIAL HANDLING & STORAGE



# SAFETY SIGNS & IDENTIFICATION



## FRENCH SMOKING CONTROL



Mat'l	7" x 10"	10" x 14"
VS	SP045	SP046
VP	SP043	SP044
VA	SP041	SP042



7" x 10"	10" x 14"
SP851	SP852
SP849	SP850
SP847	SP848



7" x 10"	10" x 14"
SP837	SP838
SP835	SP836
SP833	SP834

## FRENCH TRAFFIC INDUSTRIAL



7" x 10"	10" x 14"
SP143	SP144
SP141	SP142
SP139	SP140



7" x 10"	10" x 14"
SP359	SP360
SP357	SP358
SP355	SP356



7" x 10"	10" x 14"
SP679	SP680
SP677	SP678
SAZ669	SP676

## FRENCH FIRE & EMERGENCY EXITS



Mat'l	7" x 10"	10" x 14"
VS	SEF856	SEG350
VP	SEF855	SEG349
VA	SEF854	SEG348



7" x 10"	10" x 14"
SAZ600	SAZ601
SAZ598	SAZ599
SAZ596	SAZ597



7" x 10"	10" x 14"
SP103	SP104
SP100	SP101
SP098	SP099



7" x 10"	10" x 14"
SP095	SP096
SP093	SP094
SP091	SP092



7" x 10"	10" x 14"
SEA330	SEA333
SEA329	SEA332
SEA328	SEA331



7" x 10"	10" x 14"
SP059	SP060
SP057	SP058
SP055	SP056



Mat'l	7" x 10"	10" x 14"
VS	SAZ611	SAZ612
VP	SQ093	SQ094
VA	SQ091	SQ092



7" x 10"	10" x 14"
SP038	SP039
SP036	SP037
SP034	SP035



10" x 7"	14" x 10"
SAZ619	SAZ620
SAZ618	SP077
SAZ617	SP076



10" x 7"	14" x 10"
SAZ627	SAZ628
SP081	SAZ626
SP080	SAZ625



10" x 7"	14" x 10"
SAZ633	SAZ634
SAZ631	SAZ632
SAZ629	SAZ630



10" x 7"	14" x 10"
SAZ623	SAZ624
SAZ622	SP084
SAZ621	SP083



Mat'l	7" x 10"	10" x 14"
VS	SAZ605	SAZ606
VP	S0998	SAZ604
VA	SAZ602	SAZ603



7" x 10"	10" x 14"
SAZ590	SAZ591
SP003	SAZ589
SP002	SAZ588



7" x 10"	10" x 14"
SAZ586	SAZ587
SP007	SAZ585
SP006	SAZ584



7" x 10"	10" x 14"
SP693	SP694
SP691	SP692
SP689	SP690



7" x 10"	10" x 14"
S0984	S0985
S0983	SAZ583
S0982	SAZ582

Price/Each

Material Code	Material	7" x 10"	10" x 14"
VS	Adhesive Vinyl	13.20	19.80
VP	Plastic	14.40	21.50
VA	Aluminum	20.50	34.10

## FRENCH EMERGENCY



10" x 14"  
SED439



5" x 14"  
SED440 (left)  
SED441 (right)



2" x 14"  
SED443



3" x 14"  
SED442

Pressure Sensitive Only



4" x 12"  
SEK406

Size"	Material	Price /Each
2 x 14	Aluminum	13.10
3 x 14	Aluminum	13.10
4 x 12	Adhesive Vinyl	9.55
5 x 14	Aluminum	20.50
10 x 14	Aluminum	34.10



ACCUFORM®

IF YOU DO NOT SEE THE LEGEND OR SIZE YOU ARE LOOKING FOR PLEASE CALL US!

## BRADYGLO® RUNNING MAN EXIT SIGNS

- Replaces the familiar red EXIT signs with "Green Running Man" sign
- Safely leads people to an exit
- Goes beyond lingual limitations as it is simply a pictorial depiction of a man running through an exit door
- Install BradyGlo® Photoluminescent exit signs only in locations where an external illumination source is present
- ULS S572 Listed for high location, and indoor use only
- Should not be exposed to direct sunlight, liquid spray or temperature outside the range of 10 °C to 40 °C
- Should be mounted in a manner that ensures rigidity and mechanical sufficiency
- Sign face can be periodically cleaned with a damp cloth; thinners or solvents should not be used on the sign frame
- Rated viewing distance of 15.24 m (50')
- Maximum operating time of 90 minutes
- Meets CAN/ULC-S572-10
- Dimensions: 15" W x 8-1/2" H



SDN122



SDN131



SDN136



SDN145



Model No.	Mfg. No.	Type	Display Type	Legend	Price /Each
<b>UNFRAMED</b>					
SDN122	143527	Single-Sided	Bolt-On	Running Man w/Left Arrow	120.00
SDN123	143528	Single-Sided	Bolt-On	Running Man w/Right Arrow	120.00
SDN124	143540	Single-Sided	Bolt-On	Running Man w/Upwards Arrow	120.00
SDN125	143539	Single-Sided	Bolt-On	Running Man w/Downwards Arrow	120.00
SDN126	143541	Single-Sided	Bolt-On	Running Man w/Up and to the Left Arrow	120.00
SDN127	143542	Single-Sided	Bolt-On	Running Man w/Down and to the Left Arrow	120.00
SDN128	143543	Single-Sided	Bolt-On	Running Man w/Up and to the Right Arrow	120.00
SDN129	143544	Single-Sided	Bolt-On	Running Man w/Down and to the Right Arrow	120.00
<b>FRAMED - SURFACE MOUNT</b>					
SDN130	143517	Single-Sided	Bolt-On	Running Man w/Left Arrow	148.00
SDN131	143518	Single-Sided	Bolt-On	Running Man w/Right Arrow	148.00
SDN132	143530	Single-Sided	Bolt-On	Running Man w/Upwards Arrow	148.00
SDN133	143529	Single-Sided	Bolt-On	Running Man w/Downwards Arrow	148.00
<b>FRAMED - UNIVERSAL MOUNT</b>					
SDN134	143521	Single-Sided	Hanging	Running Man w/Left Arrow	175.00
SDN135	143522	Single-Sided	Hanging	Running Man w/Right Arrow	175.00
SDN136	143534	Single-Sided	Hanging	Running Man w/Upwards Arrow	175.00
SDN137	143533	Single-Sided	Hanging	Running Man w/Downwards Arrow	175.00
SDN138	143523	Double-Sided	Hanging	Running Man w/Left Arrow	285.00
SDN139	143524	Double-Sided	Hanging	Running Man w/Right Arrow	285.00
SDN140	143536	Double-Sided	Hanging	Running Man w/Upwards Arrow	285.00
SDN141	143535	Double-Sided	Hanging	Running Man w/Downwards Arrow	285.00
<b>FRAMED - T-BAR MOUNT</b>					
SDN142	143519	Single-Sided	Hanging	Running Man w/Left Arrow	223.00
SDN143	143520	Single-Sided	Hanging	Running Man w/Right Arrow	223.00
SDN144	143523	Single-Sided	Hanging	Running Man w/Upwards Arrow	223.00
SDN145	143531	Single-Sided	Hanging	Running Man w/Downwards Arrow	223.00
SDN146	143525	Double-Sided	Hanging	Running Man w/Left Arrow	335.00
SDN147	143526	Double-Sided	Hanging	Running Man w/Right Arrow	335.00
SDN148	143528	Double-Sided	Hanging	Running Man w/Upwards Arrow	335.00
SDN149	143537	Double-Sided	Hanging	Running Man w/Downwards Arrow	335.00

## GLOW-IN-THE-DARK ARROW TAPE

- Self-sticking polyester material
- Daylight color is off-white
- Provides a glowing directional guide when there is no light
- Length: 15'
- Exceeds ASTM E 2072-00 standard specification

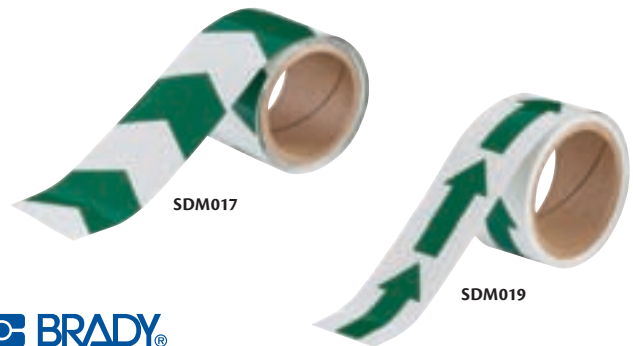

Model No.	Mfg. No.	Style	Width"	Price /Each
SDM017	90971	V Arrow	2	108.00
SDM018	90972	V Arrow	3	152.00
SDM019	90973	Standard Arrow	2	108.00
SDM020	90974	Standard Arrow	3	152.00

## EVACUATION MAP HOLDERS

- Printed with clear bold letters in the border to readily identify evacuation map, and is designed to easily accommodate 8.5" x 11" or 11" x 17" clear transparency film inserts (sold separately)
- Map can be printed from any computer and slides easily into the holder
- Made from 0.040" clear durable polycarbonate face with a plastic back
- Includes adhesive foam strips for mounting

SEC863



### STANDARD HOLDERS

Model No.	Mfg. No.	Fits Insert Sizes"	Overall Size"	Price /Each
<b>ENGLISH</b>				
SEC863	DTA235	8 1/2 x 11	11 1/2 x 12	82.70
SEC864	DTA237	11 x 17	15 x 17 1/2	97.00
<b>FRENCH</b>				
SEE336	DTA235	8 1/2 x 11	11 1/2 x 12	82.70
SEE337	DTA237	11 x 17	15 x 17 1/2	97.00

### CLEAR INSERTS

Sold in Packages of 2

Model No.	Mfg. No.	Size"	Price /Each
SEC866	DTA213	8 1/2 x 11	17.20
SEC867	DTA215	11 x 17	28.90

# SAFETY SIGNS & IDENTIFICATION

## PROJECTION™ SIGNS

- 0.10" thick high-impact plastic
- 3D signs, projecting 45° from the wall, provide optimum viewing from front and sides
- 90D signs, projecting 90° from the wall, are viewed from either side
- Includes: mounting holes and hardware



## ENGLISH



3D SAW419 90D SAW420



3D SAW431 90D SAW432



3D SAW437 90D SAW438



3D SAW439 90D SAW440



3D SAW443 90D SAW444



3D SAW445 90D SAW446



3D SAW449 90D SAW450



3D SAW453 90D SAW454



3D SAW463 90D SAW464

## FRENCH



3D SED960 90D SED961



3D SED962 90D SED963



3D SED964 90D SED965



3D SED966 90D SED967



3D SED968 90D SED969



3D SED970 90D SED971



3D SED972 90D SED973



3D SEE292 90D SEE293



3D SEE294 90D SEE295

	Panel Size	Overall Size	Standard 3D Price/Each	Standard 90D Price/Each
3D	6" x 5"	6" x 8 1/2" x 4"	23.20	—
90D	8" x 8"	8" x 8" x 1 1/2"	—	25.10







IF YOU DO NOT SEE THE LEGEND OR SIZE YOU ARE LOOKING FOR PLEASE CALL US!









# SAFETY SIGNS & IDENTIFICATION







## ENGLISH HOUSEKEEPING & HYGIENE

										
Mat'l	10" x 7"	14" x 10"	7" x 10"	10" x 14"	7" x 10"	10" x 14"	7" x 10"	10" x 14"	7" x 10"	10" x 14"
VS	SEJ231	SEJ234	SAU296	SAU299	SAU326	SAU329	SAU356	SAU359	SAU332	SAU335
VP	SEJ232	SBB439	SAU297	SAU300	SAU327	SAU330	SAU357	SAU360	SAU333	SAU336
VA	SEJ233	SEJ235	SAU298	SAU301	SAU328	SAU331	SAU358	SAU361	SAU334	SAU337

## ENGLISH FACILITY SIGNS

						
Mat'l	7" x 10"	10" x 14"	7" x 10"	10" x 14"	10" x 14"	14" x 20"
VS	SAU266	SAU269	SAU231	SAU234	SAU254	SAU257
VP	SAU267	SAU270	SAU232	SAU235	SAU255	SAU258
VA	SAU268	SAU271	SAU233	SV761	SAU256	SAU259

## FRENCH FACILITY SIGNS

						
Mat'l	14" x 10"	4" x 12"	4" x 12"	10" x 14"	14" x 10"	14" x 10"
VP	SAX648	SAX666	SAX667	SEE296	SEE300	SEE302
VA	SEA508	SAX667	SAX670	SEE297	SEE298	SEE299

## BILINGUAL FACILITY SIGNS

					
Mat'l	4" x 12"	4" x 12"	14" x 10"	14" x 10"	14" x 10"
VP	SEE304	SEE306	SAX654	SAX657	SAX660
VA	SEE305	SEE307	SEA509	SEA510	SAX661



Material Code	Material	10" x 7"	14" x 10"	4" x 12"	14" x 20"
VS	Adhesive Vinyl	13.20	19.80	-	-
VP	Plastic	14.40	21.50	21.50	21.50
VA	Aluminum	20.50	34.10	34.10	34.10

## FOLD-UP<sup>SM</sup>

- Free-standing signs to identify temporary hazardous conditions
- 0.125" rugged, high-impact plastic for multiple uses and rough handling
- 20" H x 12" W with handle cut-out, folds flat
- Same message both sides

Price/Each  
62.50



			
SEA514	SEA520	SEA521	SEA522
			
SEL052	SEL053	SEL054	SEL055

# SAFETY SIGNS & IDENTIFICATION

## CANADIAN STANDARDS ASSOCIATION IDENTIFICATION SAFETY SIGNS

Communicate regulatory, warning, or informational messages in a symbol to employees and visitors in the workplace. Use Canadian Standards Association (CSA) Z321 symbols designed to be easily understood for specific safety and/or health hazards. Symbols are divided into three classifications with each containing two sub-groups - for a combination of six colours and three shapes.

### 1. REGULATORY



**1.1 PROHIBITION**  
Forbids an Action  
(red and black  
on white)

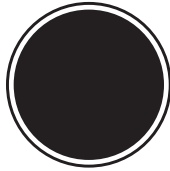

**1.2 MANDATORY**  
Requires/Obligatory  
Action  
(white on black)

### 2. WARNING



**2.1 CAUTION**  
Potential Hazard  
(black on yellow)



**2.2 DANGER**  
Definite Hazard  
(white on red)

### 3. INFORMATION

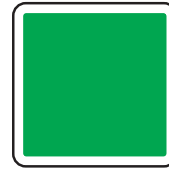

**3.1 EMERGENCY**  
First Aid, Health, Fire  
Protection, Fire Fighting, and  
Emergency Equipment  
(white on green)

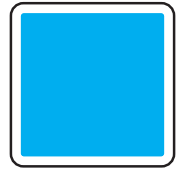

**3.2 GENERAL  
INFORMATION**  
Permission or Public  
Information  
(white on blue)











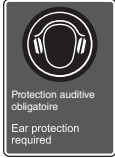





## CSA SIGNS

Safety Signs meet the Canadian Standards Association (CSA) Z321 standard for Signs and Symbols for the Workplace. Signs contain symbol with text to provide flexibility in conveying the sign message. The safety symbol is contained in a geometric shape with accompanying colours. These are uniform designs for an easily understood sign. The particular shape and colour combination distinguish the type of safety classification category. These attention-getting signs communicate the text safety information message. Signs measure 355 mm x 254 mm (14" x 10").

Available in English Only, Bilingual French-English, and French Only formats.

## DESIGN YOUR OWN CUSTOM CSA SIGN!

PROVIDE A MESSAGE,  
SELECT A PICTOGRAM SYMBOL AND  
MATERIAL AND  
LET US DO THE WORK.

							
	Ear protection required	Protection auditive obligatoire Ear protection required	Protection auditive obligatoire	Foot protection required	Chaussures de sécurité obligatoires Foot protection required	Chaussures de sécurité obligatoires	
Mat'l	English	Bilingual	French	Mat'l	English	Bilingual	French
VS	SAU896	SAU898	SAU900	VS	SAU902	SAU904	SAU906
VP	SU564	SU573	SR643	VP	SU567	SU554	SR648
VA	SAU897	SAU899	SAU901	VA	SAU903	SAU905	SAU907
							
	Gloves required	Gants obligatoires Gloves required	Gants obligatoires	Hard hats required	Casques de protection obligatoires Hard hats required	Casques de protection obligatoires	
Mat'l	English	Bilingual	French	Mat'l	English	Bilingual	French
VS	SAU908	SAU910	SAU912	VS	SAU914	SAU916	SAU918
VP	SU569	SU568	SR646	VP	SU570	SU552	SR645
VA	SAU909	SAU911	SAU913	VA	SAU915	SAU917	SAU919
							
	Respiratory protection required	Appareil respiratoire obligatoire Respiratory protection required	Appareil respiratoire obligatoire	Safety glasses required	Lunettes de sécurité obligatoires Safety glasses required	Lunettes de sécurité obligatoires	
Mat'l	English	Bilingual	French	Mat'l	English	Bilingual	French
VS	SAU920	SAU922	SAU924	VS	SAU926	SAU928	SAU930
VP	SU576	SU577	SR644	VP	SU578	SU571	SR642
VA	SAU921	SAU923	SAU925	VA	SAU927	SAU929	SAU931

Price/Each

Material Code	Material	14" x 10"
VS	Adhesive Vinyl	19.80
VP	Plastic	21.50
VA	Aluminum	34.10



ACCUFORM®

# SAFETY SIGNS & IDENTIFICATION



No entry

Mat'l  
VS  
VP  
VA

English  
SAU932  
SAI723  
SAU933



Accès interdit  
No entry

Bilingual  
SAU934  
SAI724  
SAU935



Accès interdit

French  
SAU936  
SR651  
SAU937



No smoking

Mat'l  
VS  
VP  
VA

English  
SAU938  
SAI727  
SAU939



Interdit de fumer  
No smoking

Bilingual  
SAU940  
SAI728  
SAU941



Interdit de fumer

French  
SAU942  
SR652  
SAU943



Danger!  
Corrosive materials

Mat'l  
VS  
VP  
VA

English  
SAU944  
SAU945  
SAU946



Danger!  
Matières corrosives  
Danger!  
Corrosive materials

Bilingual  
SAU947  
SAU948  
SAU949



Danger!  
Matières corrosives

French  
SAU950  
SAU951  
SAU952



Danger!  
Explosive

Mat'l  
VS  
VP  
VA

English  
SAU953  
SAU954  
SAU955



Danger!  
Explosif  
Danger!  
Explosive

Bilingual  
SAU956  
SAU957  
SAU958



Danger!  
Explosif

French  
SAU959  
SAU960  
SAU961



Danger!  
High voltage

Mat'l  
VS  
VP  
VA

English  
SAU962  
SAU963  
SAU964



Danger!  
Haute tension  
Danger!  
High voltage

Bilingual  
SAU965  
SAU966  
SAU967



Danger!  
Haute tension

French  
SAU968  
SAU969  
SAU970



Danger!  
Flammable materials

Mat'l  
VS  
VP  
VA

English  
SAU971  
SAU972  
SAU973



Danger!  
Matières inflammables  
Danger!  
Flammable materials

Bilingual  
SAU974  
SAU975  
SAU976



Danger!  
Matières inflammables

French  
SAU977  
SAU978  
SAU979



Emergency shower

Mat'l  
VS  
VP  
VA

English  
SAU980  
SAI721  
SAU981



Douche d'urgence  
Emergency shower

Bilingual  
SAU982  
SAI722  
SAU983



Douche d'urgence

French  
SAU984  
SQ118  
SAU985



Eye wash

Mat'l  
VS  
VP  
VA

English  
SAU986  
SU565  
SAU987



Bassin oculaire  
Eye wash

Bilingual  
SAU988  
SU563  
SAU989



Bassin oculaire

French  
SAU990  
SQ117  
SAU991



Fire cabinet

Mat'l  
VS  
VP  
VA

English  
SAU992  
SAU993  
SAU994



Cabinet d'incendie  
Fire cabinet

Bilingual  
SAU995  
SAU996  
SAU997



Cabinet d'incendie

French  
SAU998  
SAU999  
SAV194



Fire extinguisher

Mat'l  
VS  
VP  
VA

English  
SAV195  
SAV196  
SAV197



Extincteur d'incendie  
Fire extinguisher

Bilingual  
SAV198  
SAV199  
SAV200



Extincteur d'incendie

French  
SAV201  
SAV202  
SAV203



First Aid

Mat'l  
VS  
VP  
VA

English  
SAV204  
SU566  
SAV205



Premiers soins  
First aid

Bilingual  
SAV206  
SU572  
SAV207



Premiers soins

French  
SAV208  
SR650  
SAV209



Caution!  
Slippery surface

Mat'l  
VS  
VP  
VA

English  
SAV210  
SAV211  
SAV212



Attention!  
Surface glissante  
Caution!  
Slippery surface

Bilingual  
SAV213  
SAV214  
SAV215



Attention!  
Surface glissante

French  
SAV216  
SAV217  
SAV218

Price/Each

Material Code	Material	14" x 10"
VS	Adhesive Vinyl	19.80
VP	Plastic	21.50
VA	Aluminum	34.10



ACCUFORM®

OFFICE PRODUCTS

INSTRUMENTS, SCALES & ELECTRICAL

SHIPPING & PACKAGING

TOOLS & EQUIPMENT

WELDING & METALWORKING

SAFETY EQUIPMENT & SUPPLIES

JANITORIAL & MAINTENANCE

MATERIAL HANDLING & STORAGE



## CSA PICTOGRAM SIGNS

Pictogram signs are easily recognizable and understood symbols for communicating safety without words. Using the CSA Z321 colour symbol scheme, the signs are specific in shapes and colours to distinguish the type of message. Pictograms are ideal for conveying a message across any language barrier.

## DESIGN YOUR OWN CUSTOM CSA PICTOGRAM SIGN!

FOR OTHER CSA PICTOGRAM SIGNS, PLEASE CONTACT US AND SPECIFY SYMBOL, SHAPE, SIZE AND LET US DO THE WORK.



Mat'l	15 cm (6")	30 cm (12")	15 cm (6")	30 cm (12")	15 cm (6")	30 cm (12")	15 cm (6")	30 cm (12")	15 cm (6")	30 cm (12")	15 cm (6")	30 cm (12")
VS	SD124	SD125	SD116	SD117	SD114	SD115	SD112	SD113	SD120	SD121	SD122	SD123
VP	SAW837	SAW838	SAW839	SAW840	SAW841	SAW842	SAW843	SAW844	SAW845	SAW846	SAW847	SAW848
VA	SEA362	SEA363	SEA364	SEA365	SEA366	SEA367	SEA368	SEA369	SEA370	SEA371	SEA372	SEA373



Mat'l	15 cm (6")	30 cm (12")	15 cm (6")	30 cm (12")	15 cm (6")	30 cm (12")	15 cm (6")	30 cm (12")	15 cm (6")	30 cm (12")	15 cm (6")	30 cm (12")
VS	SD101	SD103	SD107	SD108	SD118	SD119	SD105	SD106	SD126	SD127	SD109	SD111
VP	SAW849	SAW850	SAW851	SAW852	SAW853	SAW854	SAW855	SAW856	SAW857	SAW858	SAW859	SAW860
VA	SEA374	SEA375	SEA376	SEA377	SEA378	SEA379	SEA380	SEA381	SEA382	SEA383	SEA384	SEA385



Mat'l	15 cm (6")	30 cm (12")	15 cm (6")	30 cm (12")	15 cm (6")	30 cm (12")	15 cm (6")	30 cm (12")	15 cm (6")	30 cm (12")	15 cm (6")	30 cm (12")
VS	SD140	SD141	SD144	SD145	SD136	SD138	SD152	SD153	SD148	SD149	SD150	SD151
VP	SAW861	SAW862	SAW863	SAW864	SAW865	SAW866	SAW867	SAW868	SAW869	SAW870	SAW871	SAW872
VA	SEA386	SEA387	SEA388	SEA389	SEA390	SEA391	SEA392	SEA393	SEA394	SEA395	SEA396	SEA397



Mat'l	15 cm (6")	30 cm (12")	15 cm (6")	30 cm (12")	15 cm (6")	30 cm (12")	15 cm (6")	30 cm (12")	15 cm (6")	30 cm (12")	15 cm (6")	30 cm (12")
VS	SD142	SD143	SD146	SD147	SD132	SD134	SD154	SD155	SD156	SD157	SD128	SD130
VP	SAW873	SAW874	SAW875	SAW876	SAW877	SAW878	SAW879	SAW880	SAW881	SAW882	SAW883	SAW884
VA	SEA398	SEA399	SEA400	SEA401	SEA402	SEA403	SEA404	SEA405	SEA406	SEA407	SEA408	SEA409



Mat'l	15 cm (6")	30 cm (12")	15 cm (6")	30 cm (12")	15 cm (6")	30 cm (12")	15 cm (6")	30 cm (12")	15 cm (6")	30 cm (12")	15 cm (6")	30 cm (12")
VS	SD091	SD092	SD087	SD088	SD083	SD084	SD077	SD078	SD089	SD090	SD085	SD086
VP	SAW776	SAW777	SAW778	SAW779	SAW780	SAW781	SAW782	SAW783	SAW784	SAW785	SAW774	SAW775
VA	SEA410	SEA411	SEA412	SEA413	SEA414	SEA415	SEA416	SEA417	SEA418	SEA419	SEA420	SEA421

Price/Each

Material Code	Material	15 cm (6")	30 cm (12")
VS	Adhesive Vinyl	13.20	19.80
VP	Plastic	14.40	21.50
VA	Aluminum	20.50	34.10



ACCUFORM®



# SAFETY SIGNS & IDENTIFICATION



Mat'l 15 cm (6") 30 cm (12")  
 VS SD064 SD065  
 VP SAW885 SAW886  
 VA SEA422 SEA423



15 cm (6") 30 cm (12")  
 SD053 SD055  
 SAW887 SAW888  
 SEA424 SEA425



15 cm (6") 30 cm (12")  
 SD058 SD059  
 SAW889 SAW890  
 SEA426 SEA427



15 cm (6") 30 cm (12")  
 SD068 SD070  
 SAW891 SAW892  
 SEA428 SEA429



15 cm (6") 30 cm (12")  
 SD079 SD081  
 SAW893 SAW894  
 SEA430 SEA431



15 cm (6") 30 cm (12")  
 SD066 SD067  
 SAW895 SAW896  
 SEA432 SEA433



Mat'l 15 cm (6") 30 cm (12")  
 VS SD060 SD061  
 VP SAW897 SAW898  
 VA SEA434 SEA435



15 cm (6") 30 cm (12")  
 SD075 SD076  
 SAW899 SAW900  
 SEA436 SEA437



15 cm (6") 30 cm (12")  
 SD056 SD057  
 SAW901 SAW902  
 SEA438 SEA439



15 cm (6") 30 cm (12")  
 SD062 SD063  
 SAW770 SAW771  
 SEA440 SEA441



15 cm (6") 30 cm (12")  
 SD072 SD074  
 SAW772 SAW773  
 SEA442 SEA443



15 cm (6") 30 cm (12")  
 SEA523 SEA524  
 SAW786 SAW787  
 SEA444 SEA445



Mat'l 15 cm (6") 30 cm (12")  
 VS SD207 SBA798  
 VP SAW812 SAW813  
 VA SEA446 SEA447



15 cm (6") 30 cm (12")  
 SD243 SD244  
 SAW790 SAW791  
 SEA448 SEA449



15 cm (6") 30 cm (12")  
 SD203 SD205  
 SAW828 SAW829  
 SEA450 SEA451

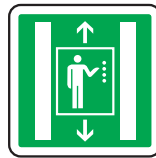

15 cm (6") 30 cm (12")  
 SD195 SD197  
 SAW794 SAW795  
 SEA452 SEA453



15 cm (6") 30 cm (12")  
 SD235 SD236  
 SAW796 SAW797  
 SEA454 SEA455



15 cm (6") 30 cm (12")  
 SD199 SD201  
 SAW798 SAW799  
 SEA456 SEA457



Mat'l 15 cm (6") 30 cm (12")  
 VS SD238 SD240  
 VP SAW800 SAW801  
 VA SEA458 SEA459



15 cm (6") 30 cm (12")  
 SD211 SD213  
 SAW802 SAW803  
 SEA460 SEA461



15 cm (6") 30 cm (12")  
 SD231 SD233  
 SAW804 SAW805  
 SEA462 SEA463



15 cm (6") 30 cm (12")  
 SD215 SD217  
 SAW806 SAW807  
 SEA464 SEA465



15 cm (6") 30 cm (12")  
 SD227 SD229  
 SAW808 SAW809  
 SEA466 SEA467



15 cm (6") 30 cm (12")  
 SD219 SD221  
 SAW810 SAW811  
 SEA468 SEA469



Mat'l 15 cm (6") 30 cm (12")  
 VS SD191 SD193  
 VP SAW788 SAW789  
 VA SEA470 SEA471



15 cm (6") 30 cm (12")  
 SD188 SD189  
 SAW814 SAW815  
 SEA472 SEA473



15 cm (6") 30 cm (12")  
 SD168 SD170  
 SAW816 SAW817  
 SEA474 SEA475



15 cm (6") 30 cm (12")  
 SD175 SD176  
 SAW818 SAW819  
 SEA476 SEA477



15 cm (6") 30 cm (12")  
 SD165 SD166  
 SAW820 SAW821  
 SEA478 SEA479



15 cm (6") 30 cm (12")  
 SD178 SD180  
 SAW822 SAW823  
 SEA480 SEA481



Mat'l 15 cm (6") 30 cm (12")  
 VS SD158 SD159  
 VP SAW824 SAW825  
 VA SEA482 SEA483



15 cm (6") 30 cm (12")  
 SD182 SD183  
 SAW826 SAW827  
 SEA484 SEA485



15 cm (6") 30 cm (12")  
 SD185 SD186  
 SAW792 SAW793  
 SEA486 SEA487



15 cm (6") 30 cm (12")  
 SD223 SD225  
 SAW830 SAW831  
 SEA488 SEA489



15 cm (6") 30 cm (12")  
 SD161 SD163  
 SAW832 SAW833  
 SEA490 SEA491



15 cm (6") 30 cm (12")  
 SD172 SD173  
 SAW834 SAW835  
 SEA492 SEA493

Price/Each

Material Code	Material	15 cm (6")	30 cm (12")
VS	Adhesive Vinyl	13.20	19.80
VP	Plastic	14.40	21.50
VA	Aluminum	20.50	34.10



ACCUFORM®

OFFICE PRODUCTS

INSTRUMENTS, SCALES & ELECTRICAL

SHIPPING & PACKAGING

TOOLS & EQUIPMENT

WELDING & METALWORKING

SAFETY EQUIPMENT & SUPPLIES

JANITORIAL & MAINTENANCE

MATERIAL HANDLING & STORAGE

# SAFETY SIGNS & IDENTIFICATION



## ISO SAFETY LABELS

- Communicate safety using internationally recognized labels as set forth by the International Organization for Standardization (ISO)
- Shapes and colours distinguish the type of safety
- Symbols communicate the specific safety message
- Adhere to documents, machinery, packaging and other areas requiring safety symbol messages
- Compliant to ISO 7010:2011 standard

High-performance, self-adhesive vinyl with overlaminated graphics for long wear and durability. Available in two sizes — specify when ordering.

ISO labels are available in three categories distinguishable by their shape and colour format:

**Mandatory** - take action to avoid the hazard.

**Prohibition** - forbid an action to avoid the hazard.

**Warning** - identify the hazard to avoid.

## MANDATORY

<b>Label Size</b> 2" (~50 mm) 4" (~100 mm)						
	Wear Eye Protection SAX255 SAX256	Wear Hearing Protection SAX316 SAX317	Wear Head Protection SAX318 SAX319	Wear Hand Protection SAX267 SAX268	Wear Face Shield & Eye Protection SAX257 SAX258	Wear Foot Protection SAX269 SAX270
<b>Label Size</b> 2" (~50 mm) 4" (~100 mm)						
	Wear Respiratory Protection SAX263 SAX264	Wear Mask SAX320 SAX321	Wear Protective Clothing SAX322 SAX323	Wear Head & Eye Protection SAX324 SAX325	Wear Head, Hearing & Eye Protection SAX326 SAX327	Wear Respiratory & Head Protection SAX328 SAX329
<b>Label Size</b> 2" (~50 mm) 4" (~100 mm)						
	Wear Safety Harness SAX330 SAX331	Unplug Electrical Supply SAX332 SAX333	Use Pedestrian Route SAX334 SAX335	Consult Technical Manual for Proper Procedure SAX336 SAX337	Wash Hands SAX338 SAX339	Lockout in De-Energized State SAX340 SAX341

## PROHIBITION

<b>Label Size</b> 2" (~50 mm) 4" (~100 mm)						
	No Pedestrians SAX342 SAX343	No Access SAX344 SAX345	Do Not Extinguish with Water SAX346 SAX347	Not Drinking Water SAX348 SAX349	Do Not Expose to Water SAX350 SAX351	No Smoking SAX352 SAX353
<b>Label Size</b> 2" (~50 mm) 4" (~100 mm)						
	No Fire or Open Flame SAX354 SAX355	Do Not Remove Guard SAX356 SAX357	Do Not Throw Switch SAX358 SAX359	Do Not Touch Electrical Hazard SAX360 SAX361	Do Not Touch Surface SAX362 SAX363	Do Not Touch SAX364 SAX365
<b>Label Size</b> 2" (~50 mm) 4" (~100 mm)						
	No Pacemakers SAX366 SAX367	No Portable Transmitters SAX368 SAX369	No Eating or Drinking SAX370 SAX371	No Industrial Trucks SAX372 SAX373		



Label Size	Qty/Pkg.	Price/Pkg.
2" (~50 mm)	10	45.00
4" (~100 mm)	5	40.90

# SAFETY SIGNS & IDENTIFICATION

## WARNING



General Warning Hazard  
SAX374  
SAX375

Label Size  
2" (~50 mm)  
4" (~100 mm)



Tripping Hazard  
SAX376  
SAX377



Slippery  
Surface Hazard  
SAX378  
SAX379



Tipping Hazard  
SAX380  
SAX381



Lifting Hazard  
SAX382  
SAX383



Step Off Hazard  
SAX384  
SAX385



Lift Truck Hazard  
SAX386  
SAX387

Label Size  
2" (~50 mm)  
4" (~100 mm)



Crush Hazard  
SAX388  
SAX389



Crush Hazard  
SAX390  
SAX391



Pinch Point Hazard  
SAX392  
SAX393



Belt Drive  
Entanglement Hazard  
SAX394  
SAX395



Chain Drive  
Entanglement Hazard  
SAX396  
SAX397



Gear  
Entanglement Hazard  
SAX398  
SAX399

Label Size  
2" (~50 mm)  
4" (~100 mm)



Cut or Sever Hazard  
SAX400  
SAX401



Automatic or Remote Starting  
Hazard  
SAX402  
SAX403



Corrosive/Acid Hazard  
SAX404  
SAX405



Splash Hazard  
SAX406  
SAX407



Toxic Hazard  
SAX408  
SAX409



Battery Hazard  
SAX410  
SAX411

Label Size  
2" (~50 mm)  
4" (~100 mm)



Electric  
Ground Hazard  
SAX412  
SAX413



Static  
Sensitive Hazard  
SAX414  
SAX415



Electro  
Magnetic Hazard  
SAX416  
SAX417



Strong Magnetic  
Field Hazard  
SAX418  
SAX419



Electric  
Voltage Hazard  
SAX420  
SAX421



Voltage  
Discharge Hazard  
SAX422  
SAX423

Label Size  
2" (~50 mm)  
4" (~100 mm)



Radioactive  
Material Hazard  
SAX424  
SAX425



Low Temperature  
Hazard  
SAX426  
SAX427



Explosive  
Atmosphere Hazard  
SAX428  
SAX429



Explosives Hazard  
SAX430  
SAX431



Fire Hazard  
SAX432  
SAX433



Heated/Hot  
Surface Hazard  
SAX434  
SAX435

Label Size  
2" (~50 mm)  
4" (~100 mm)



Oxidizing  
Materials Hazard  
SAX436  
SAX437



Laser Hazard  
SAX438  
SAX439



UV Hazard  
SAX440  
SAX441



ACCUFORM.

Label Size	Qty/Pkg.	Price/Pkg.
2" (~50 mm)	10	45.00
4" (~100 mm)	5	40.90

IF YOU DO NOT SEE THE LEGEND OR SIZE YOU ARE LOOKING FOR PLEASE CALL US!

OFFICE  
PRODUCTS

INSTRUMENTS,  
SCALES &  
ELECTRICAL

SHIPPING &  
PACKAGING

TOOLS &  
EQUIPMENT

WELDING &  
METALWORKING

SAFETY  
EQUIPMENT  
& SUPPLIES

JANITORIAL &  
MAINTENANCE

MATERIAL  
HANDLING &  
STORAGE

819

# SAFETY SIGNS & IDENTIFICATION



Post traffic signs to safely direct and regulate the flow of vehicles and pedestrians in and around parking areas, dock areas, and roadways. Keep driveways, throughways, and curbs free of vehicles and direct to designated parking locations with proper signs.

- Heavy-duty, 0.080" aluminum signs will not rust
- Reflective sign face provides added visibility in low-light conditions
- UV-resistant inks prevent fading during long-term outdoor use
- Supplied with top and bottom centre holes for post- or fence-mounting

## MATERIAL

**High Intensity (HP)** – High intensity prismatic sheeting is over three times brighter than standard engineer-grade sheeting.

**Aluminum (AL)**: Lightweight 0.032" aluminum with enamel non-reflective finish

## TRAFFIC REGULATORY SIGNS



Mat'l	30" x 30"	36" x 36"
HP	SAX448	SAX449
Price/Each	\$242.00	\$306.00



24" x 24"
SAX451
\$175.00



24" x 24"
SEC345
\$162.00



24" x 24"
SEC331
\$81.60



24" x 24"
SEA940
\$81.60



30" x 24"	HP
10	SAX463
15	SAX464
20	SAX465
25	SAX466
30	SAX467
Price/Each	\$234.00

Other speeds also available. Contact us for details.



30" x 24"	HP
10	SAX473
15	SAX474
20	SAX475
25	SAX476
30	SAX477
Price/Each	\$234.00

Other speeds also available. Contact us for details.



Mat'l	12" x 36"
AL	SAX478
Price/Each	\$120.00



Mat'l	12" x 36"
HP	SEJ246
Price/Each	\$146.00



Mat'l	12" x 36"
HP	SEJ247
Price/Each	\$146.00



Mat'l	24" x 24"
HP	SEA975
Price/Each	\$68.00



24" x 24"
SEA977
\$68.60



24" x 24"
SEA973
\$68.60



24" x 24"
SEA998
\$83.70



24" x 24"
SEA956
\$83.70



Mat'l	24" x 24"
HP	SEA988
Price/Each	\$83.70



24" x 24"
SEA984
\$83.70



24" x 24"
SEA985
\$68.60



24" x 24"
SEA992
\$83.70



## WARNING SIGNS

**High Intensity (HP)** – High intensity prismatic sheeting is over three times brighter than standard engineer-grade sheeting.



Mat'l  
HP

24" x 24" SEJ254  
30" x 30" SEJ255



24" x 24" SAX543  
30" x 30" SAX544



24" x 24" SAX546



30" x 30" SAX552



30" x 30" SAX558



Mat'l  
HP

24" x 24" SEJ256  
30" x 30" SEJ257



24" x 24" SEJ258  
30" x 30" SEJ259



24" x 6" SAX573  
36" x 12" SAX574



24" x 6" SAX577  
36" x 12" SAX578



36" x 36" SAX586

Price/Each



Size	High Intensity – HP
24" x 6" (60 cm x 15 cm)	65.90
36" x 12" (90 cm x 30 cm)	146.00
24" x 24" (60 cm x 60 cm)	195.00
30" x 30" (75 cm x 75 cm)	269.00
36" x 36" (90 cm x 90 cm)	340.00

## PARKING SIGNS

**Engineer Reflective (RA)** – Engineer grade reflective sign face provides added visibility in low-light condition.



12" x 12" SAX504



12" x 18" SAX505



12" x 18" SAX506



12" x 18" SAX507



12" x 18" SAX508



12" x 18" SAX509



12" x 18" SAX511



12" x 18" SAX513  
18" x 24" SAX514



12" x 18" SAX515  
18" x 24" SAX516



12" x 18" SAX523



12" x 6" SAX527



Price/Each

Size	Engineer Reflective – RA
6" x 12" (15 cm x 30 cm)	34.10
12" x 12" (30 cm x 30 cm)	54.30
18" x 12" (45 cm x 30 cm)	60.20
24" x 18" (60 cm x 45 cm)	120.00

## SIGN POSTS & HARDWARE

- Available in three sizes\*: 8', 10' and 12' posts
- Hardware set (sold separately) contains one nut, one bolt, one washer, and one spacer; two sets per installation are required
- Galvanized
- SAO201: Screw Diameter: 3/8" Screw Length: 2"



\*Other lengths also available. Contact us for details.

Model No.	Description	Length'	Price/Each
SAO195	Post	8	53.20
SAO196	Post	10	65.50
SAO197	Post	12	78.10
SAO201	Hardware Set	-	2.68
SAO725	3" Base	4	32.60



# SAFETY SIGNS & IDENTIFICATION



## DIGI-DAY & DIGI-DAY PLUS+ ELECTRONIC SCOREBOARDS

Count up safe work days with attention-getting, lighted display scoreboard. Proudly show safe work days that counts up electronically and automatically. If a lost time accident occurs, it's easy to set the display back to zero.

- Innovatively designed frameless construction in durable lightweight aluminum
- Image goes to the edge, then wraps 2" deep for visual edge, unmistakable impact
- Incorporates Digi-Day® or Digi-Day® Plus+ display technology
- Built-in hidden mounting system
- Easy-to-use remote included

Want to create your own? Call our customer service department today to get started!

### DIGI-DAY®

#### Specifications:

- For indoor use
- 28" x 20" x 2" frameless aluminum
- Four-digit, bright red LED display with 4" H numbers
- Operates on 110 VAC with 6' power cord

### DIGI-DAY® PLUS+

#### Specifications:

- For wet, damp, harsh locations\*
- 36" x 24" x 2" frameless aluminum
- Four-digit, bright red LED display with 4" H numbers
- Operates on 110 VAC with 12' power cord
- Meets IP65 for dust and water resistance
- \* For wet environment exposure, plug into GFI electrical outlet with weatherproof protective receptacle cover.



*PERSONALIZE IT!*

	Size	Price/Each
Digi-Day®	28" x 20"	390.00
Digi-Day® Plus	36" x 24"	852.00



Digi-Day®  
Digi-Day® Plus+

SED513  
SEJ372



SAR081  
SEJ368



SAV226  
SEJ373



SAV227  
SEJ369

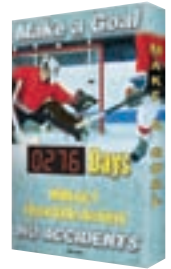

SAV228  
SEJ374



Digi-Day®  
Digi-Day® Plus+

SED518  
SEF820



SED519  
SEF819



SED520  
SEJ370



SED521  
SEF814

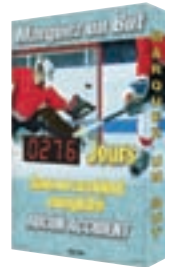

SED522  
SEF371

## DIGI-DAY®2 ELECTRONIC SCOREBOARDS

Scoreboard counts up safe work days in two colors with Digi-Day®2 display. Proudly display safe work days in safety green that counts up electronically and automatically. If a lost time accident occurs, set the display back to red until meeting the new safe work days goal by turning back to green.

- Set the display to count days only or flash between count days, date, and clock
- Track the 7-day week, or set the display to track only your company's work days
- Display count can be set to freeze or hold with indicator
- In a power failure, all information is stored – operation resumes when power returns with notification indicator
- Frameless 28" x 20" x 2" aluminum scoreboard with image to the edges then wraps around for visual depth
- Easy-to-use remote included

#### SPECIFICATIONS:

- For indoor use
- 28" x 20" x 2" frameless aluminum
- Four-digit, bright red LED display with 2 1/2" H numbers
- Built-in hidden mounting system
- Operates on 110 VAC with 6' power cord

Size	Price/Each
28" x 20"	468.00



SEJ362 - English  
SEL058 - French



SEJ363 - English  
SEL059 - French



SEJ364 - English  
SEL060 - French



SEJ365 - English  
SEL061 - French



SEJ366 - English  
SEL062 - French



SEJ367 - English  
SEL063 - French



## REALLY BIG SIGNAL SCOREBOARDS

PROMOTE SAFETY AWARENESS IN A BIG WAY WITH A SIGNAL SAFETY SCOREBOARD

- Attention-getting scoreboard is large at 6-feet wide and 3-feet tall with 6" deep aluminum frame surrounding the sign cabinet
- Includes full-size three-signal traffic light
- Operate red, yellow and green light to promote the safety status of the workplace with steady-on or flashing lights (relay available separately)
- Signal lights individually controlled by switches

- Bold colours and large letters are printed onto durable plastic front face
- Choose numbering system to keep track and notify of "safe working" days - Digi-Day® Numbers - bright, red LED digital numbers automatically advance by one every 24 hours. Set it and run it from a remote control.
- Operates on 110 VAC with 8-ft power cord and grounded plug
- For indoor use only



SAS428  
SAS429

2 1/2" Digi-Day®  
4" Digi-Day®



SAS431  
SAS432

2 1/2" Digi-Day®  
4" Digi-Day®

English Model No.	French Model No.	Description	Price /Each
SAS428	SAS431	w/2 1/2" Digi-Day® Numbers	3172.00
SAS429	SAS432	w/4" Digi-Day® Numbers	3485.00

\*Customized scoreboards also available. Call for details.

## WRITE-A-DAY SCOREBOARDS

- Easily update safe working days with dry-erase marker
- Wipe-off and write-in on poly-coated space
- Constructed of durable plastic for indoor locations
- Has corner mounting holes

Size	Price/Each
20" x 14"	61.40
28" x 20"	81.50

### ACCESSORIES

Model No.	Description	Price/Each
PE774	Bullet Tip Dry Erase Marker, Black	2.04



English 20" x 14" SAV221 28" x 20" SAV222



French 20" x 14" SEE334 28" x 20" SEE335



English 20" x 14" SAV223 28" x 20" SAV224  
French SEL064 SEL065



English 20" x 14" SAV219 28" x 20" SAV220  
French SEL066 SEL067



English 20" x 14" SEJ377 28" x 20" SEJ378  
French SEL068 SEL069



English 20" x 14" SEJ379 28" x 20" SEJ380  
French SEL070 SEL071





## PORTABLE LABEL PRINTERS

CREATE CUSTOM LABELS ANYTIME... ANY PLACE...



Model No. SEK071  
Mfg. No. BMP21-PLUS  
Price/Each \$112.12

### BMP\*21 PLUS

The Brady BMP\*21 PLUS printer combines toolbox-ready ruggedness and world class materials in an economical grab-and-go printer. The BMP\*21 PLUS thermal transfer printer creates clear, legible, industrial strength labels that will stay stuck for years – even in the harshest environments

- Ergonomic, center-balanced, printer with grab-and-go ridged grip for solid handling
- Two line LCD display provides clear visibility
- Smart Cell technology for automatic label set up and automatic formatting for wire wraps, terminal blocks, patch panels, cable flags and general labels
- Multi-functional accessory with magnet, flashlight and retractable printer stand for easy handling



Model No. SEC447  
Mfg. No. BMP71  
Price/Each \$1066.70

### BMP\*71 LABEL PRINTERS

The BMP\*71 Label Printer is our most versatile labeler for on-the-job printing. It prints on more than 400 different label parts, and has a convenient handle and rechargeable battery.

- Large, full color graphical display
- Simple step-by-step label design
- High-speed print (1.5" per second!)
- Hundreds of symbols and graphics including bar codes
- 200 MB of storage for all your label saving needs
- No calibration required for setup or supply changes

\*HandiMark Tapes compatible with this printer



Model No. SEH653  
Mfg. No. 75447314703  
Price/Each \$504.52

### BMP\*51 LABEL MAKERS

The BMP\*51 label maker helps you get the job done faster, easier and with confidence.

You can carry this printer throughout your facility to quickly and easily make labels on the go.

- Large, graphical display with backlight
- Quick and easy label design
- Fast printing (1" per second)
- Prints labels up to 1.5" wide or continuous labels up to 40'
- More than 20 material types and over 190 label parts
- Material recognition and automatic label formatting - no calibration necessary
- Built-in Bluetooth® technology for wireless printing (optional Wi-Fi and Ethernet cards also available)
- Rechargeable Li-ion battery pack



Model No. SEH658  
Mfg. No. 75447314704  
Price/Each \$402.55

### BMP\*53 LABEL MAKERS

- Same great features as the BMP\*51 label maker without the screen or keyboard
- Use LabelMark™ or CodeSoft™ software or Brady's Mobile App on your smartphone to create labels
- Uses the same label cartridges as BMP\*51

	BMP*21-Plus	BMP*71 Label Printers	BMP*51 Label Maker	BMP*53 Label Maker
<b>Max Labels per Day</b>	75 labels/day	1000 labels/day	500	500
<b>Print Resolution</b>	203 dpi	300 dpi	300 dpi	300 dpi
<b>Print Technology</b>	Thermal Transfer	Thermal Transfer	Thermal Transfer	Thermal transfer
<b>Print Speed</b>	10 mm / sec	38 mm/sec	25 mm/sec	25 mm/sec
<b>Tape Widths</b>	1/4" to 3/4"	Various sizes from 0.25" to 2.00"	Various sizes from 0.235" to 1.50"	0.235" to 1.50"
<b>Max Label Width</b>	0.75"	2.00"	1.50"	1.50"
<b>Max Print Width</b>	N/A	1.75"	1.25"	1.25"
<b>Memory</b>	Last label	200Mb	48 MB/25,000 labels	Files saved to PC
<b>Materials Supported</b>	Continuous/70 Stock Parts	Continuous, Die Cut labels, Bulk, over 400 stock parts	Continuous, Die Cut, 140+ stock parts	Continuous, die cut, 140+ stock parts
<b>Continuous vs Die Cut Labels</b>	Continuous Labels only	Can print both continuous and die cut labels	Can print both continuous and die-cut labels	Can print both continuous and die-cut labels
<b>Peripheral Printing</b>	No	Yes	Yes	Yes
<b>File Transfer from PC to printer</b>	No	Yes	Yes	Yes
<b>Stand Alone Printing</b>	Yes	Yes	Yes	No
<b>Connectivity Options</b>	None	USB	USB, Bluetooth (WIFI and Ethernet optional)	USB, Bluetooth (WIFI and Ethernet optional)
<b>Keyboard</b>	ABC	QWERTY	QWERTY	N/A
<b>Backlit Screen</b>	Yes	Yes	Yes	N/A
<b>Text Sizes</b>	6 (6 to 40 pt)	4 to 174 pt	4 to 103 point + auto-sizing	4 to 103 point + auto-sizing
<b>Multi-Line Print</b>	Yes	Yes	Yes	Yes
<b>Serialization</b>	Yes	Yes - multiple and linked	Yes	Yes
<b>Barcode</b>	39 and 128	39 and 128	39 and 128	All LabelMark™ supported bar codes
<b>Symbols</b>	125	Over 500	444	All LabelMark™ supported symbols
<b>Portability</b>	Yes	Yes	Yes	Yes
<b>Label Types or Application Functions?</b>	Wire, Banner Portrait, Banner Landscape, Terminal Block, Patch Panel, Fixed Length	Banner Portrait, Banner Landscape, Wire, Flag Labels, Patch Panel, Terminal Block, Desi Strip, 110 Block, 66 Block, Bix Block, Fixed Length, Pipe Markers, Safety Labels	Banner Portrait, Banner Landscape, Wire, Flag Labels, Patch Panel, Terminal Block, Desi Strip, 110-Block, 66-Block, Bix Block, Fixed Length, Small Pipe Markers	Banner Portrait, Banner Landscape, Wire, Flag Labels, Patch Panel, Terminal Block, Desi Strip, 110-Block, 66-Block, Bix Block, Fixed Length
<b>Applications</b>	Data Communications Labeling, Facility, Safety & Maintenance Identification, General & Industrial Labeling, Panel Identification, Wire & Cable Marking	Circuit Board Labeling, Data Communications Labeling, Facility, Safety & Maintenance Identification, General & Industrial Labeling, Health Care Identification, Laboratory Identification, Panel Identification, Security Identification, Wire & Cable Marking, Pipe Marking	Data Communications Labeling, Facility, Safety & Maintenance Identification, General & Industrial Labeling, Laboratory Identification, Panel Identification, Security Identification, Wire & Cable Marking, Pipe Marking	Data Communications Labeling, Facility, Safety & Maintenance Identification, General & Industrial Labeling, Laboratory Identification, Panel Identification, Security Identification, Wire & Cable Marking
<b>Power Supply</b>	6 AA Batteries, AC Power (optional)	Rechargeable Battery, AC Power	Eight AA Batteries, AC Power, Rechargeable Li-Ion Battery Pack	Eight AA Batteries, AC Power, Rechargeable Li-Ion Battery Pack
<b>Weight</b>	1.66 lbs.	5.49 lbs.	3.18 lbs.	2.18 lbs.



## BMP®21 PLUS

The Brady BMP®21-PLUS printer combines toolbox-ready ruggedness and world class materials in an economical grab-and-go printer. The BMP®21-PLUS thermal transfer printer creates clear, legible, industrial strength labels that will stay stuck for years – even in the harshest environments

- Ergonomic, center-balanced, printer with grab-and-go ridged grip for solid handling
- Two line LCD display provides clear visibility
- Smart Cell technology for automatic label set up and automatic formatting for wire wraps, terminal blocks, patch panels, cable flags and general labels
- Multi-functional accessory with magnet, flashlight and retractable printer stand for easy handling



Model No.	Mfg. No.	Description	Price/Each
SEK071	BMP21-PLUS	Mobile Printer	112.12
SEK079	M-AC-110937	AC PWR/Charger	48.00
SEK074	BMP21-PLUS-HC	Hard Carrying Case	41.59
SEC608	BMP21-MAGNET	Magnet	19.17
SEC609	BMP21-TOOL	Multifunctional Accessory	36.25

## BMP™21-PLUS TAPES & RIBBONS



SELF-LAMINATING VINYL - CONTINUOUS BLACK ON WHITE  
SELF-LAMINATING WIRE MARKER - 14' ROLL (#M)

Priced per roll

Model No.	Mfg. No.	Size"	Price/Each
SEC610	M21-750-427	3/4	36.48
SEC611	M21-1000-427	1	40.41
SEC612	M21-1250-427	1 1/4	42.89
SEC613	M21-1500-427	1 1/2	42.40

PERMASLEEVE™ WIRE MARKER SLEEVES - 7' ROLL (#M)

CONTINUOUS CUT-TO-LENGTH HEAT SHRINKABLE SLEEVES

Priced per roll

Model No.	Mfg. No.	Size"	Price/Each
SEC614	M21-125-C-342	0.125	51.82
SEC615	M21-187-C-342	0.187	55.71
SEC616	M21-250-C-342	0.250	63.59
SEC617	M21-375-C-342	0.375	72.12



For all your shelving and storage needs take a look at our selection starting on page 4



INDOOR/OUTDOOR GRADE VINYL TAPE - 21' CARTRIDGE  
SUPER-TOUGH VINYL TAPE - PERFECT FOR VOICE, DATA, AUDIO, VIDEO, HV/AC CONTROL, BINS, SAFETY AND ELECTRICAL APPLICATIONS

Priced per roll

Black on White Model No.	White on Red Model No.	White on Blue Model No.	White on Green Model No.	Black on Orange Model No.	Dimensions	Price /Each
SEB059	SEB061	SEB062	SEB063	SEB064	3/8" x 21'	24.73
SEB065	SEB071	SEB068	SEB069	SEB070	1/2" x 21'	25.97
SEB065	SEB079	SEB076	SEB077	SEB078	3/4" x 21'	29.82

POLYESTER - 21' ROLL BLACK ON WHITE FOR COMPONENTS, INSTRUMENTS, RACKS AND BINS

Priced per roll

Model No.	Mfg. No.	Size"	Price/Each
SEB055	M21-375-423	3/8	25.40
SEB056	M21-500-423	1/5	26.55
SEB073	M21-750-423	3/4	31.17

POLYESTER - 21' ROLL BLACK ON CLEAR FOR COMPONENTS, INSTRUMENTS, RACKS AND BINS

Priced per roll

Model No.	Mfg. No.	Size"	Price/Each
SEB057	M21-375-430	3/8	24.29
SEB058	M21-500-430	1/5	25.32
SEB074	M21-750-430	3/4	27.08

NYLON CLOTH - 16' ROLL FOR WIRE, CABLE, PATCH PANELS AND FACE-PLATES

Priced per roll

Model No.	Mfg. No.	Size"	Price/Each
SEB067	M21-375-499	3/8	30.96
SEB072	M21-500-499	1/5	32.12
SEB081	M21-750-499	3/4	34.64

# LABELLING SYSTEMS & SUPPLIES

## BMP™71 LABEL PRINTERS

The BMP™71 Label Printer is our most versatile labeler for on-the-job printing. It prints on more than 400 different label parts, and has a convenient handle and rechargeable battery.

- Large, full color graphical display
- Simple step-by-step label design
- High-speed print (1.5" per second!)
- Hundreds of symbols and graphics including bar codes
- 200 MB of storage for all your label saving needs
- No calibration required for setup or supply changes

\*HandiMark Tapes compatible with this printer



Model No.	Mfg. No.	Description	Price /Each
SEC447	BMP71	Label Printer	1066.70
SEC659	BMP71-LM	Label Printer With Labelmark Software	1222.17
SEC660	BMP71-MW	Label Printer With Markware Lean Software	1595.03
SEC661	BMP71-QC	Label Printer With Quick Charger	1139.31
SEC662	BMP71-SC	Label Printer With Soft Case	1077.16
SEC663	BMP71-SC-QC	Label Printer With Soft Case And Quick Charger	1191.09
SEC664	M71-AC-BC	AC/Battery Adaptor	67.00
SEC665	M71-ADAPT	TLS/HandiMark Media Adaptor	24.02
SEC666	M71-CLEAN	Cleaning Kit	18.42
SEC667	M71-HC	Hard Case	91.83
SEC668	M71-QC	Quick Charger	138.81
SEC669	M71-BATT	Battery Pack	101.44

## SELF-LAMINATING WIRE MARKERS

Protected printing area offers superior chemical and abrasion resistance. Features a non-printed clear area that wraps around and overlaminates the printed text.



SEC755

Model No.	Mfg. No.	Labels /Roll	Approx. Wire Gauge	Label Dimensions"	Price /Each
SEC755	BM71-21-427	1000	Cables	1 x 2.5 x 0.75	238.16
SEC756	M71-21-427	100	Cables	1 x 2.5 x 0.75	33.73
SEC757	BM71-11-427	5000	16-10	0.50 x 0.75 x 0.38	323.40
SEC758	BM71-17-427	5000	12-10	0.50 x 1 x 0.38	345.88
SEC759	BM71-19-427	2500	12-10	1 x 1 x 0.38	310.41
SEC760	M71-19-427	250	12-10	1 x 1 x 0.38	43.61
SEC761	BM71-29-427	5000	10-4	0.50 x 1.5 x 0.5	418.78
SEC762	M71-18-427	250	10-4	0.75 x 1 x 0.38	39.63
SEC763	BM71-31-427	2500	10-4	1 x 1.5 x 0.5	399.40
SEC764	M71-31-427	250	10-4	1 x 1.5 x 0.5	56.29
SEC765	M71-32-427	250	10-4	1.5 x 1.5 x 0.5	57.80

## PERMASLEEVES™ WIRE MARKERS

These full circle heat-shrink sleeves are the ultimate in marker durability, performance and aesthetic appearance. Fast shrink rate saves time and costs during installation.

Model No.	Mfg. No.	Labels /Roll	Approx. Wire Gauge	Label Dimensions"	Price /Each
SEC740	BM71-94-1-342	2500	28-12	1.02 x 0.18	995.39
SEC741	M71-94-1-342	100	28-18	1.02 x 0.18	55.73
SEC742	BM71-125-1-342	1000	22-16	1.02 x 0.24	412.78
SEC743	M71-125-1-342	100	22-16	1.02 x 0.24	59.66
SEC744	BM71-125-175-342	1000	22-16	1.77 x 0.24	554.58
SEC745	BM71-187-1-342	100	18-12	1.02 x 0.34	460.51
SEC746	M71-187-1-342	100	18-12	1.02 x 0.34	66.44
SEC747	BM71-250-1-342	1000	16-10	1.02 x 0.44	557.13
SEC748	M71-250-1-342	100	16-10	1.02 x 0.44	80.48
SEC749	BM71-250-175-342	1000	16-10	1.77 x 0.44	750.04
SEC750	BM71-375-1-342	1000	12-6	1.02 x 0.65	822.19

## INDOOR/OUTDOOR GRADE VINYL TAPE – 50' ROLL

Indoor/outdoor pliable vinyl conforms to smooth or rough surfaces such as pipes, walls, doors, panels, shelving, bins and equipment. Aggressive permanent adhesive; labels offer excellent resistance to oils, detergents, dirt, grime and many solvents.



SEC537

Model No.	Mfg. No.	Label Dimensions"	Colour	Price/Each
SEC537	M71C-500-595-BK	1/2	Black	57.59
SEC531	M71C-500-595-BL	1/2	Blue	57.59
SEC525	M71C-500-595-GN	1/2	Green	57.59
SEC534	M71C-500-595-OR	1/2	Orange	57.59
SEC519	M71C-500-595-WT	1/2	White	57.59
SEC522	M71C-500-595-YL	1/2	Yellow	57.59
SEC538	M71C-1000-595-BK	1	Black	79.99
SEC532	M71C-1000-595-BL	1	Blue	79.99
SEC526	M71C-1000-595-GN	1	Green	79.99
SEC535	M71C-1000-595-OR	1	Orange	79.99
SEC520	M71C-1000-595-WT	1	White	79.99
SEC523	M71C-1000-595-YL	1	Yellow	79.99

## BMP®71 RIBBONS

• 2" x 150'

SEC791

Model No.	Mfg. No.	Series	Description	Price/Each
SEC791	M71-R6000	6000	Black Ribbon	70.13
SEC792	M71-R4300	4300	Black Ribbon	70.13
SEC793	M71-R4400-WT	4400	White Ribbon	82.90
SEC794	M71-R6900-RD	6900	Red Ribbon	82.90
SEC795	M71-R6900-BL	6900	Blue Ribbon	82.90
SEC796	M71-R6900-YL	6900	Yellow Ribbon	82.90



**ZENITH**  
Safety Products

## Safety Products for Industry

## BMP®51 LABEL MAKERS

The BMP®51 label maker helps you get the job done faster, easier and with confidence. You can carry this printer throughout your facility to quickly and easily make labels on the go.

- Large, graphical display with backlight
- Quick and easy label design
- Fast printing (1" per second)
- Prints labels up to 1.5" wide or continuous labels up to 40'
- More than 20 material types and over 190 label parts
- Material recognition and automatic label forming - no calibration necessary
- Built-in Bluetooth® technology for wireless printing (optional Wi-Fi and Ethernet cards also available)
- Rechargeable Li-ion battery pack



Model No.	Mfg. No.	Description	Price /Each
SEH653	75447314703	Label Printer w/Rechargeable Li-ion Battery Pack and AC Adaptor/Battery Charger	504.52
SEH651	75447314707	Label Printer w/AC Adaptor	482.10
SEH652	75447314705	Label Printer w/LabelMark™ 5 Software and AC Adaptor	649.15
SEH654	75447370842	Electrical Starter Kit	728.75
SEH655	75447370843	Facility Identification Starter Kit	751.17
SEH656	75447370844	Lab Identification Starter Kit	717.54
SEH657	75447370841	Voice and Data Communications Starter Kit	711.93

## BMP®53 LABEL MAKERS

- Same great features as the BMP®51 label maker without the screen or keyboard
- Use LabelMark™ or CodeSoft™ software or Brady's Mobile App on your smartphone to create labels
- Uses the same label cartridges as BMP®51



Model No.	Mfg. No.	Description	Price /Each
SEH664	75447314708	Peripheral Printer w/ AC Adaptor	380.12
SEH658	75447314704	Label Printer w/Rechargeable Li-ion Battery Pack and AC Adaptor/Battery Charger	402.55
SEH659	75447314706	Label Printer w/LabelMark™ 5 Software and AC Adaptor	546.70
SEH660	66282098156	Facility Identification Starter Kit	775.20
SEH661	66282098154	Voice and Data Communications Starter Kit	737.83
SEH662	66282098155	Electrical Starter Kit	758.11
SEH663	66282098157	Lab Identification Starter Kit	744.23

## CARTRIDGES FOR BMP®51 & BMP®53

### B-595 INDOOR/OUTDOOR GRADE FACILITY & SAFETY LABELS

- Pliable vinyl conforms well to smooth or rough surfaces such as pipes, panels, shelving, bins, and equipment
- Excellent resistance to oils, detergents, dirt, grime, and many solvents
- Label lasts up to 8-10 years outdoors



Model No.	Mfg. No.	Colour	Label Dimensions		Price /Each
			H" x L"		
SEH672	MC-500-595-BK-WT	Black on White	1/2 x 300		40.10
SEH673	MC-750-595-BK-WT	Black on White	3/4 x 300		49.81
SEH675	MC-1500-595-BK-WT	Black on White	1 1/2 x 300		65.90
SEH676	MC-750-595-YL-BK	Yellow on White	3/4 x 300		46.39
SEH677	MC-750-595-OR-BK	Black on Orange	3/4 x 300		46.39
SEH678	MC-750-595-BL-WT	White on Blue	3/4 x 300		46.39
SEH679	MC-750-595-RD-WT	White on Red	3/4 x 300		46.39
SEH680	MC-750-595-GN-WT	White on Green	3/4 x 300		46.39
SEH681	MC-750-595-WT-RD	Red on White	3/4 x 300		46.39
SEH682	MC-750-595-WT-BK	White on Black	3/4 x 300		46.39
SEH683	MC-750-595-CL-BK	Black on Clear	3/4 x 240		36.95
SEH684	MC-500-595-CL-WT	White on Clear	1/2 x 240		31.17
SEH685	MC-750-595-CL-WT	White on Clear	3/4 x 240		36.95
SEH687	MC-1500-595-CL-WT	White on Clear	1 1/2 x 240		52.21

### PUNCH BLOCK & PATCH PANEL LABELS

- Make fully-formatted punch block strips or labels in one easy process with built-in templates, LabelMark™ 5 software or the Brady Mobile App
- Black text on white



Model No.	Mfg. No.	Material	Label Dimensions		Price /Each
			H" x L"		
SEH665	MC-375-412	Polypropylene Tag	3/8 x 240		42.93
SEH666	MC-625-412	Polypropylene Tag	5/8 x 240		55.05
SEH667	MC-625-422	Gloss Polyester	5/8 x 300		48.42
SEH668*	M-78-432-CL-BK	Clear Polyester	1 x 19/10		43.49
SEH669	M-97-481	StainerBondz Polyester	9/10 x 9/10		59.16
SEH670	M-83-492	Freezerbondz II Polyester	1/2" x 1/2		38.20
SEH671	MC-500-492	Freezerbondz II Polyester	1/2 x 300		54.11

\* Black text on clear

### B-499 NYLON LABELS

- Adheres to smooth and rough surfaces



Model No.	Mfg. No.	Colour	Label Dimension		Price /Each
			H" x L"		
SEH688	M-82-499-RD-BK	Black on Red	3/8 Dia.		36.00
SEH689	M-83-499-OR-BK	Black on Orange	3/8 Dia.		36.00
SEH690	M-83-499-RD-BK	Black on Red	1/2 Dia.		36.00
SEH691	MC-1000-499	Black on White	1 x 192		53.12
SEH692	MC-375-499	Black on White	3/8 x 192		47.64
SEH693	MC-500-499	Black on White	1/2 x 192		49.56
SEH694	MC-750-499	Black on White	3/4 x 192		51.51

### B-584 REFLECTIVE LABELS

- Highly reflective labels shine back brightly when struck by light



Model No.	Mfg. No.	Colour	Label Dimension		Price /Each
			H" x L"		
SEH699	MC-500-584	Black on White Reflective Tape	1/2 x 240		65.71
SEH700	MC-750-584	Black on White Reflective Tape	3/4 x 240		80.13
SEH701	MC-1000-584	Black on White Reflective Tape	1 x 240		82.89
SEH702	MC-1500-584	Black on White Reflective Tape	1 1/2 x 240		97.66
SEH703	MC-500-584-YL	Black on Yellow Reflective Tape	1/2 x 240		65.71
SEH704	MC-750-584-YL	Black on Yellow Reflective Tape	3/4 x 240		80.13
SEH705	MC-1000-584-YL	Black on Yellow Reflective Tape	1 x 240		82.89
SEH706	MC-1500-584-YL	Black on Yellow Reflective Tape	1 1/2 x 240		97.66

### B-427 VINYL SELF-LAMINATING WIRE & CABLE MARKERS

- Features a clear, non-printable "tail" that wraps around the wire and serves as an overlaminate to the printed text
- Protected print area offers superior chemical and abrasion resistance
- Continuous
- Black text on white



Model No.	Mfg. No.	Label Dimensions		Write-On Area"	Wire Gauge	Max. Wire Diameter mm	Price /Each
		H" x L"					
SEH695	MC-750-427	3/4 x 300		3/4	16-10	6.86	49.17
SEH696	MC-1000-427	1 x 300		3/4	12-10	21.59	65.82
SEH697	MC-1250-427	1 1/4 x 300		1/2	10-4	13.46	66.83
SEH698	MC-1500-427	1 1/2 x 300		1/2	10-4	6.86	68.13



# LABELLING SYSTEMS & SUPPLIES

## BBP®31 SIGN & LABEL PRINTERS

This monochrome sign and label printer can print on labels 1/2" to 4" wide. Designed for ease of use and versatility, this printer features an intuitive touch screen display, simple label design, and a wide variety of material applications.



Model No.	Mfg. No.	Description	Price /Each
SEC766	BBP31	Sign & Label Maker	2103.50
SEC767	B31-WIPER	Media Wiper Pack	27.49
SEC768	B31-STYLUS	Replacement Stylus	14.50
SEC769	B31-CCT	Cutter Cleaning Tool	15.48

## BBP®35 MULTICOLOUR SIGN & LABEL PRINTERS

- Creates colourful workplace visuals that make an impact
- With automatic setup, 20-second material change out, and a 5-inch per second print speed, your signs and labels will be printed and in your hands in nearly no time at all
- Choose from 28 industrial-grade label and ribbon materials that simply set or click into place without calibration or threading
- The BBP35 Printer can connect to a PC but also operates as a stand-alone printer
- The built-in touchscreen interface and preset label templates make label creation a breeze
- Display Size: 3.63" W x 6" H - 21.78 sq. in.
- Tape Width Range: 0.5" - 4"
- Print Speed: 5 IPS



SDS615

Model No.	Mfg. No.	Description	Price /Each
SDS615	BBP35	BBP®35 Multicolour Sign & Label Printer	3390.00

## LOW-HALIDE POLYESTER B-569 TAPE

- For labelling stainless steel and smooth surfaces
- Can be used in BBP®31, BBP®33, BBP®35 and BBP®37 printers



Colour	2.25" x 100' Model No.	Mfg. No.	Price /Each	1.125" x 100' Model No.	Mfg. No.	Price /Each
White	SEC770	B30C-2250-569-WT	201.98	SEC776	B30C-1125-569-WT	139.81
Yellow	SEC771	B30C-2250-569-YL	201.98	SEC777	B30C-1125-569-YL	139.81
Blue	SEC772	B30C-2250-569-BL	201.98	SEC778	B30C-1125-569-BL	139.81
Green	SEC773	B30C-2250-569-GN	201.98	SEC779	B30C-1125-569-GN	139.81
Orange	SEC774	B30C-2250-569-OR	201.98	SEC780	B30C-1125-569-OR	139.81
Red	SEC775	B30C-2250-569-RD	201.98	SEC781	B30C-1125-569-RD	139.81

## BBP®33 LABEL PRINTERS

- Hassle-free operation
- Automatic label set-up with no calibration
- No wasted labels – prints on the very first label
- Record fast material changeovers
- Foolproof "drop-in" ribbon and label cartridges
- No threading the ribbon around spools and print heads
- Ink side of ribbon always faces the right way
- Printer is compatible with Markware Software, LabelMark Software and CodeSoft Labeling Software
- Applications: Wire & Cable, Arc Flash, Rating Plates, Electrical & Automation, Product ID, Electronics, Safety & Facility, Lean5S, GHS and Pipemarkers
- Dimensions: 9.51" H x 9.08" W x 12" D
- Weight: 11.7 lbs



Model No.	Mfg. No.	Description	Price /Each
SEH076	BBP33	BBP®33 Label Printer	1548.26

## BBP®37 COLOUR & CUT SIGN & LABEL PRINTER

- With automatic label setup, 20-second material change out, and a 5-inch per second print speed, waiting for signs and labels is a thing of the past
- Create bright and colourful labels and signs that really make an impact in your facility
- With 28 different industrial grade label and ribbon materials to choose from, you can print visuals for nearly any facility application
- Materials simply click or set into place without calibration or threading
- With the XY cutter, you can create die-cut shapes and text that give you the flexibility to put your messages where you need them most
- The BBP37 Printer can connect to a PC but also operates as a stand-alone printer
- The built-in touchscreen interface and preset label templates makes label creation a breeze
- Display Size: 3.63" W x 6" H - 21.78 sq. in.
- Tape Width Range: 0.5" - 4"
- Print Speed: 5 IPS
- Replacement blade for BBP®37 Colour & Cut Sign & Label Printer available



SDS616

Model No.	Mfg. No.	Description	Price /Each
SDS616	BBP37	BBP®37 Colour & Cut Sign & Label Printer	4843.00
SDS617	B37-BLADE	Replacement Blade	110.00

## B-584 RETRO REFLECTIVE TAPE

- For highly reflective material shines back brightly when struck by light
- Ideal for labeling outdoor utility poles and pedestals, jobsite equipment and roof-top equipment
- Colour: Silver
- Dimensions: 4" W x 600" L
- Recommended for low light or inclement weather conditions
- Can be used in BBP®31, BBP®33, BBP®35 and BBP®37 printers

Model No. SEH883  
Mfg. No. B30C-4000-584-SL  
Price/Each \$388.52





## INDOOR/OUTDOOR VINYL B-595 TAPE

- For general facility identification
- Durable, low-shrink vinyl with our most aggressive adhesive
- Conforms to irregular, curved, rough and highly textured surfaces
- Can be used in BBP\*31, BBP\*33, BBP\*35 and BBP\*37 printers



4" x 100'				3" x 100'				2.25" x 100'				1.125" x 100'				0.5" x 100'			
Colour	Model No.	Mfg. No.	Price /Each	Model No.	Mfg. No.	Price /Each	Model No.	Mfg. No.	Price /Each	Model No.	Mfg. No.	Price /Each	Model No.	Mfg. No.	Price /Each				
White	SEC632	B30C-4000-595-WT	282.40	SEC638	B30C-3000-595-WT	251.02	SEC640	B30C-2250-595-WT	188.26	SEC646	B30C-1125-595-WT	125.49	SEC652	B30C-500-595-WT	78.36				
Yellow	SEC633	B30C-4000-595-YL	282.40	SEC639	B30C-3000-595-YL	251.02	SEC641	B30C-2250-595-YL	188.26	SEC647	B30C-1125-595-YL	125.49	SEC653	B30C-500-595-YL	78.36				
Red	SEC634	B30C-4000-595-RD	282.40	-	-	-	SEC642	B30C-2250-595-RD	188.26	SEC648	B30C-1125-595-RD	125.49	SEC654	B30C-500-595-RD	78.36				
Blue	SEC635	B30C-4000-595-BL	282.40	-	-	-	SEC643	B30C-2250-595-BL	188.26	SEC649	B30C-1125-595-BL	125.49	SEC655	B30C-500-595-BL	78.36				
Green	SEC636	B30C-4000-595-GN	282.40	-	-	-	SEC644	B30C-2250-595-GN	188.26	SEC650	B30C-1125-595-GN	125.49	SEC656	B30C-500-595-GN	78.36				
Orange	SEC637	B30C-4000-595-OR	282.40	-	-	-	SEC645	B30C-2250-595-OR	188.26	SEC651	B30C-1125-595-OR	125.49	SEC657	B30C-500-595-OR	78.36				
Black	-	-	-	-	-	-	SEH861	B30C-2250-595-BK	188.26	-	-	-	-	-	-				

## B-7569 PRE-PRINTED GHS/CLP CHEMICAL LABELS

- Blank labels with pre-printed red diamonds allow printer to produce 2-colour GHS/CLP labels in one print pass
- Three sizes of labels, each with six diamond layouts that match templates in MarkWare software
- Indoor/outdoor vinyl material withstands exposure to moisture, chemicals and handling
- Can be used in BBP\*31, BBP\*33, BBP\*35 and BBP\*37 printers



L1 diamant



L2 diamant



L3A diamant

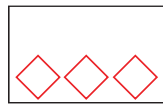

L3B diamant

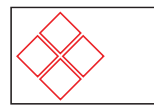

L4A diamant

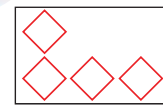

L4B diamant

Model No.	Mfg. No.	Legend	Dimensions			Price /Each
			W"	x	H"	
SEH862	B30-260-7569-CLP1	L1 Diamond + Text	3.350	x	2.170	140.33
SEH863	B30-260-7569-CLP2	L2 Diamond + Text	3.350	x	2.170	140.33
SEH864	B30-260-7569-CLP3A	L3A Diamond + Text	3.350	x	2.170	140.33
SEH865	B30-260-7569-CLP3B	L3B Diamond + Text	3.350	x	2.170	140.33
SEH866	B30-260-7569-CLP4A	L4A Diamond + Text	3.350	x	2.170	140.33
SEH867	B30-260-7569-CLP4B	L4B Diamond + Text	3.350	x	2.170	140.33
SEH868	B30-261-7569-CLP1	L1 Diamond + Text	4.330	x	2.950	155.81
SEH869	B30-261-7569-CLP2	L2 Diamond + Text	4.330	x	2.950	155.81
SEH870	B30-261-7569-CLP3A	L3A Diamond + Text	4.330	x	2.950	155.81
SEH871	B30-261-7569-CLP3B	L3B Diamond + Text	4.330	x	2.950	155.81
SEH872	B30-261-7569-CLP4A	L4A Diamond + Text	3.350	x	2.170	155.81
SEH873	B30-261-7569-CLP4B	L4B Diamond + Text	3.350	x	2.170	155.81
SEH874	B30-262-7569-CLP1	L1 Diamond + Text	6.100	x	4.130	187.87
SEH875	B30-262-7569-CLP2	L2 Diamond + Text	6.100	x	4.130	187.87
SEH876	B30-262-7569-CLP3A	L3A Diamond + Text	6.100	x	4.130	187.87
SEH878	B30-262-7569-CLP3B	L3B Diamond + Text	6.100	x	4.130	187.87
SEH879	B30-262-7569-CLP4A	L4A Diamond + Text	3.350	x	2.170	187.87
SEH880	B30-262-7569-CLP4B	L4B Diamond + Text	3.350	x	2.170	187.87

**Afraid of Heights...  
We've Got You Covered!**

**KLETON**

**Canada's Leading  
Material Handling Supplier**



# LABELLING SYSTEMS & SUPPLIES

## GLOBALMARK®2 INDUSTRIAL GRADE PRINT RIBBONS

- Super-tough smear-proof ribbons assure your printed text lasts for years outdoors and in an industrial environment
- Ribbons are self-contained in cartridges that drop straight into the GlobalMark® with a "click"
- 4-colour panelled ribbons are used to print labels and signs containing more than 1 print colour



### SINGLE COLOUR PRINT RIBBON CARTRIDGES - 200'/ROLL

Priced per Roll

Colour	Model No.	Mfg. No.	Panels	Price /Each
Black	SAG953	76739	4.11" x 200'	137.82
White	SAG954	76741	4.11" x 200'	137.82
Red	SAG955	76743	4.11" x 200'	137.82
Blue	SAG956	76745	4.11" x 200'	137.82
Green	SAG957	76747	4.11" x 200'	137.82
Magenta	SAG958	76749	4.11" x 200'	137.82
Yellow	SAG959	76751	4.11" x 200'	137.82

### TWO COLOUR PRINT RIBBON CARTRIDGES - 200'/ROLL

Priced per Roll

Colour	Model No.	Mfg. No.	Panels	Price /Each
Black and Red	SAG964	76763	4.11" x 8"	140.46
Black and Blue	SAG965	76775	4.11" x 8"	140.46
Black and Orange	SAG967	76771	4.11" x 8"	140.46
Black and Red	SAG969	76762	4.11" x 16"	140.46
Black and Blue	SAG970	76774	4.11" x 16"	140.46
Black and Orange	SAG972	76770	4.11" x 16"	140.46

### FOUR COLOUR PRINT RIBBON CARTRIDGES - 200'/ROLL

Priced per Roll

Colour	Model No.	Mfg. No.	Panels	Price /Each
Black/Red/Blue/Yellow	SAG975	76791	4.11" x 8"	143.13
Black/Red/Blue/Green	SAG977	76786	4.11" x 16"	143.13
Cyan/Magenta/Yellow/Black	SAG979	76794	4.11" x 16"	143.13



## INDOOR/OUTDOOR GRADE VINYL TAPE

- Labels adhere well to pipes, walls, equipment, windows and most clean, dry surfaces
- Conforms well to irregular, curved or rough surfaces, it even stands up to grease, oil and most industrial chemicals
- 5-year average outdoor durability in temperatures from 180°F to -40°F
- 100' per roll
- For GlobalMark printers

Colour	4" W Model No.	Mfg. No.	Price /Each	3" W Model No.	Mfg. No.	Price /Each	2.25" W Model No.	Mfg. No.	Price /Each	1.125" W Model No.	Mfg. No.	Price /Each	0.5" W Model No.	Mfg. No.	Price /Each
White	SAG895	113109	302.87	SAG909	113110	269.21	SAG911	113111	201.89	SAG925	113112	134.57	SAG939	113113	84.06
Yellow	SAG896	113114	302.87	SAG910	113115	269.21	SAG912	113116	201.89	SAG926	113117	134.57	SAG940	113118	84.06
Red	SAG897	113119	302.87	N/A	-	-	SAG913	113120	201.89	SAG927	113121	134.57	SAG941	113122	84.06
Green	SAG898	113123	302.87	N/A	-	-	SAG914	113124	201.89	SAG928	113125	134.57	SAG942	113126	84.06
Blue	SAG899	113127	302.87	N/A	-	-	SAG915	113128	201.89	SAG929	113129	134.57	SAG943	113130	84.06
Black	SAG900	113131	302.87	N/A	-	-	SAG916	113132	201.89	SAG930	113133	134.57	SAG944	113134	84.06
Grey	SAG903	113143	302.87	N/A	-	-	SAG919	113144	201.89	SAG933	113145	134.57	SAG947	113146	84.06
Orange	SAG905	113151	302.87	N/A	-	-	SAG921	113152	201.89	SAG935	113153	134.57	SAG949	113154	84.06

830

MATERIAL HANDLING & STORAGE

JANITORIAL & MAINTENANCE

SAFETY EQUIPMENT & SUPPLIES

WELDING & METALWORKING

TOOLS & EQUIPMENT

SHIPPING & PACKAGING

INSTRUMENTS, SCALES & ELECTRICAL

OFFICE PRODUCTS

## B-342 PERMASLEEVE® PS POLYOLEFIN WIRE MARKING SLEEVES

- Full circle heat-shrink sleeves are the ultimate in marker durability, performance and aesthetic appearance
- Fast shrink rate saves time and costs during installation
- Can be used in BBP®33 printers only



Model No.	Mfg. No.	Colour	For Wire Gauge	For Wire Diameters"	Price /Each
SEH843	B33-125-2-342	White	22 to 16	0.046-1.11	619.00
SEH844	B33-187-2-342	White	20 to 10	0.062-0.150	604.00
SEH845	B33-187-2-342-2	White	20 to 10	0.062-0.150	604.00
SEH846	B33-250-2-342	White	16 to 8	0.094-0.215	540.00
SEH847	B33-250-2-342-2	White	16 to 8	0.094-0.215	540.00
SEH848	B33-375-2-342	White	12 to 4	0.125-0.320	691.00
SEH849	B33-750-2-342	White	6 to 4/0	0.250-0.700	469.00
SEH850	B33-250-2-342YL	Yellow	6 to 4/0	0.250-0.700	540.00

## B30 SERIES PRINTER RIBBONS

- "Drop & Click" print ribbons for quick and easy supply changes
- Print can withstand years in industrial areas and outdoor conditions
- Can be used in BBP®31 BBP®33, BBP®35 and BBP®37 printers



### MODELS SEC786 TO SEC789

- 4.33" x 200'

### MODELS SDS623, SDS630, SDS632, SDS640

- 4.33" x 16"

### MODELS SDS624, SDS631, SDS633, SDS641

- 4.33" x 8"



Colour	Model No.	Mfg. No.	Price/Each
White	SEC786	B30-R10000-WT	125.97
Black	SEC787	B30-R10000	125.97
Black*	SEC790	B30-R4300	61.46
Red	SEC788	B30-R10000-RD	125.97
Blue	SEC789	B30-R10000-BL	125.97
Cyan/Magenta/Yellow/Black	SDS623	B30-R10000-CMYK-16	141.00
Cyan/Magenta/Yellow/Black	SDS624	B30-R10000-CMYK-8	141.00
Black/Orange	SDS630	B30-R10000-KO-16	138.00
Black/Orange	SDS631	B30-R10000-KO-8	138.00
Black/Red	SDS632	B30-R10000-KR-16	138.00
Black/Red	SDS633	B30-R10000-KR-8	138.00
Black/Yellow	SDS640	B30-R10000-KY-16	138.00
Black/Yellow	SDS641	B30-R10000-KY-8	138.00

\* Black is for use with B-427 material only





## PIPE MARKERS – WHAT YOU NEED TO KNOW

The proper marking of contents and flow direction in pipes and piping systems is a vital component of a thorough safety and identification program.



A13.1 – 2007 scheme for the identification of piping systems... A uniform system for the identification of piping contents has been established to warn personnel when the piping contents are inherently hazardous... This standard has been prepared to specify the identification of the contents of piping systems on the basis of legends, it also suggests the use of colour as a supplementary means of identifying the type of hazard of the material contained in the system.

Pipe markers are designed to meet or exceed ASME (ANSI) A13.1-2007 recommendations for size, colour and visibility.

Pipe markers are quick visual cues, providing immediate identification information of pipe contents for emergency responders and workers to safely carry out their responsibilities when working in and around piping systems.

The legend or wording on the pipe marker is to be the primary means of naming the contents of the pipe. The name is to be brief, yet complete or in understood abbreviated format. Arrows are to accompany the legend to indicate the directional flow of the contents. Additional information may be necessary to identify the content details such as pressure and temperature.

### Installation recommendations:

- Above or below centre visual line of pipe
- Frequent intervals on straight pipe runs (visible from any point along the length)
- Close to valves
- Near branches and T's in piping
- Any change in direction of piping
- Near points before and after pipe going through walls, ceilings, and floors



29 CFR 1910.253 Oxygen-fuel gas welding and cutting (d)(4)(ii) Aboveground piping systems shall be marked in accordance with the American National Standard Scheme for the identification of piping systems, ANSI A13.1

1910.261 Pulp, paper, and paperboard mills (a)(3)

General incorporation of standards. Establishments subject to this section shall comply with the following standards:

1910.261(a)(3)(ii) Scheme for the identification of piping systems, A13.1

1910.262 Textiles

1910.262(c)(7) Identification of piping systems. Identification of piping systems shall conform to American National Standard A13.1

## LETTER HEIGHT & PIPE MARKER SIZES

The outside diameter of the pipe determines the letter height and background field length of the marker.

Outside Diameter of Pipe"	Length of Pipe Marker Colour Field"	Size of Letters"
3/4 to 1 1/4	8	1/2
1 1/2 to 2	8	3/4
2 1/2 to 6	12	1 1/4
8 to 10	24	2 1/2
Over 10*	32	3 1/2

\*Available as custom pipe markers

## LEGEND

The legend on the marker gives the name of the contents in full or abbreviated form. Arrows should be used to indicate direction of flow.

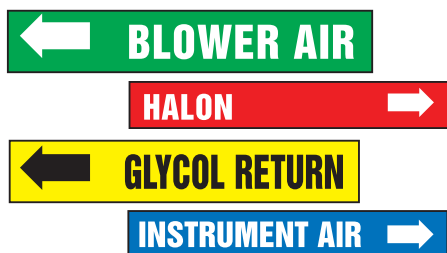

## COLOURS

Colours identify the characteristic hazards of the contents of the piping system.

Contents of the Pipe	Colour
Fire Quenching Fluids	WHITE ON RED
Toxic And Corrosive Fluids	BLACK ON ORANGE
Flammable Fluids	BLACK ON YELLOW
Combustible Fluids	WHITE ON BROWN
Potable, Cooling, Boiler Feed, And Other Water	WHITE ON GREEN
Compressed Air	WHITE ON BLUE

## VISIBILITY & LOCATION

Where pipe lines are located high or low, place the lettering below or above the horizontal centerline of the pipe. Affix markers onto piping close to valves or flanges and adjacent to changes in direction, branches, and where pipes pass through walls or floors; and at 25' to 50' intervals on long straight pipe runs.

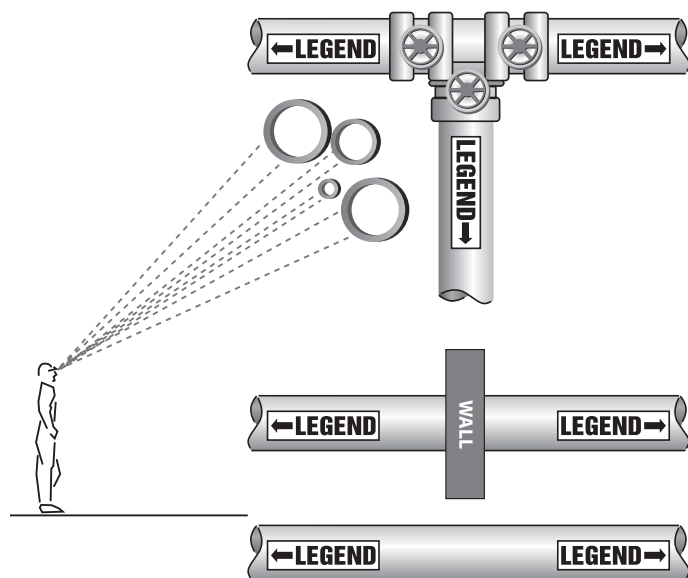

Pipes installed at a distance may make pipe markers difficult to read (refer to the distance reading chart). We can provide larger, legible pipe markers to meet your requirements. Please contact us for solutions.

# LABELLING SYSTEMS & SUPPLIES



**ACCUFORM.**

## CGSP PIPE MARKERS

MARK PIPES TO IDENTIFY AND LABEL HAZARDOUS AND NON-HAZARDOUS SUBSTANCES CONTAINED IN PIPING SYSTEMS BY USING COLOUR, LEGEND, AND PICTOGRAM.

Create pipe markers based on the Canadian General Standard Board CAN/CGSB-24.3-92

The combination of text with Workplace Hazard Materials Information System (WHMIS) symbols provides an impact and quick understanding of the pipe contents.

Comply with the guidelines in marking pipes by providing workers and emergency personnel the ability to easily identify contents of pipes in the event the contents could release into the environment.

When WHMIS controlled substances are contained in piping systems, the appropriate WHMIS symbol(s) are to be included on the pipe marker with the legend.

### WHMIS SYMBOLS:



### HOW TO ORDER:

1. SPECIFY WHMIS HAZARD SYMBOL(S) – IF NECESSARY.
2. SPECIFY LEGEND OF PIPE CONTENT.
3. SPECIFY DIRECTIONAL ARROW – IF NECESSARY.

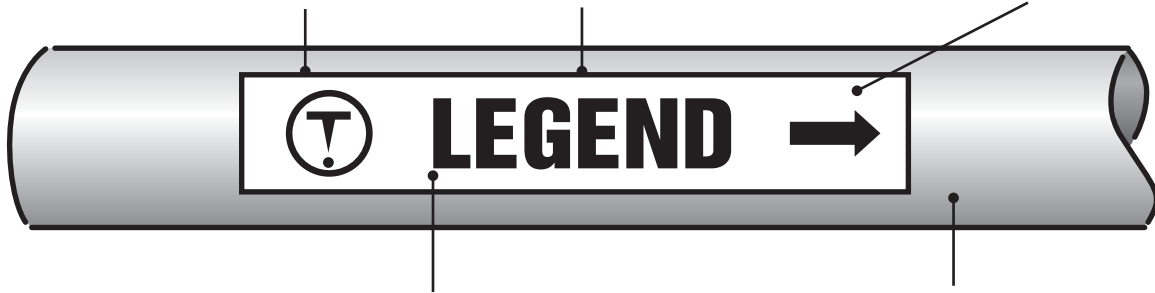

4. POINT OUT COLOUR COMBINATION.

Contents of the Pipe	Colour
Hazardous	BLACK ON YELLOW
Low Hazard Material	WHITE ON GREEN
Low Hazard Gas	WHITE ON BLUE
Fire Protection	WHITE ON RED

5. CHOOSE SIZE BASED ON PIPE SIZE.

Outside Diameter of Pipe Marker	Length Colour Field	Size of Letters
19 to 32 mm (3/4" to 1 1/4")	200 mm (8 inches)	13 mm (1/2")
38 to 51 mm (1 1/2" to 2")	200 mm (8 inches)	19 mm (3/4")
64 to 150 mm (2 1/4" to 6")	300 mm (12 inches)	32 mm (1 1/4")
200 to 250 mm (8" to 10")	600 mm (24 inches)	64 mm (2 1/2")
Over 250 mm (Over 10")	800 mm (32 inches)	89 mm (3 1/2")

6. SELECT PIPE MARKER TYPE BY PART NUMBER ALONG WITH QUANTITY.

#### SELF-STICK VINYL MARKERS

One legend is printed on the 4-mil flexible vinyl marker. Install on clean, smooth surface. Peel off liner backing and affix to the pipe with the high tack adhesive back. Marker withstands various environmental conditions. Arrow is provided for proper directional flow indication.

Fit Pipe Diameter	Marker Size
19 to 32 mm (3/4" to 1 1/4")	25 x 200 mm (1" x 8")
38 to 51 mm (1 1/2" to 2")	38 x 200 mm (1 1/2" x 8")
64 to 150 mm (2 1/4" to 6")	64 x 300 mm (2 1/2" x 12")
200 to 250 mm (8" to 10")	100 x 600 mm (4" x 24")
Over 250 mm (10")	114 x 800 mm (4 1/2" x 32")
Other Size	

**Call for Pricing**

#### SNAP TITE™ MARKERS

Pre-coiled design 'snaps' back around to fit around the pipe. 20-mil rigid vinyl is printed repeatedly with the legend and directional flow arrow, upright and upside-down, around the marker for universal direction fit and visibility. Ideal for warm and cool pipes – easily install on and remove from pipes that are insulated, unpainted, and less perfection conditions.

Fit Pipe Diameter	Marker Size
19 to 32 mm (3/4" to 1 1/4")	150 x 200 mm (6" x 8")
38 to 51 mm (1 1/2" to 2")	229 x 200 mm (9" x 8")
64 to 76 mm (2 1/4" - 3")	355 x 300 mm (14" x 12")
83 to 127 mm (3 1/4" to 5")	483 x 300 mm (19" x 12")
133 to 150 mm (5 1/4" to 6")	635 x 300 mm (25" x 12")

**Call for Pricing**

\* Comes with Self-Adhesive Leading Edge.





## DIRECTIONAL FLOW ARROW TAPES

- Provide 360° visibility for flow direction with printed arrows repeated the entire tape length
- 6-mil vinyl tape has self-adhesive back
- Available in four standard ANSI colours
- Available wound in 54' rolls.

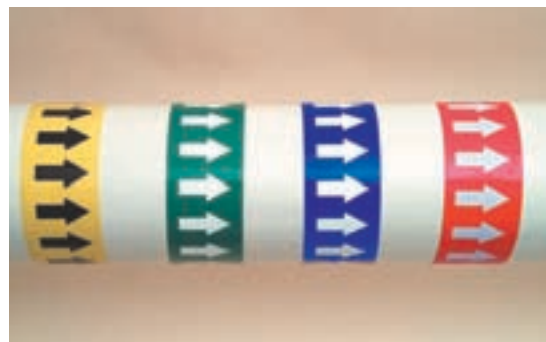

ASME A13.1, 3.1 "Arrows shall be used to indicate direction of flow."

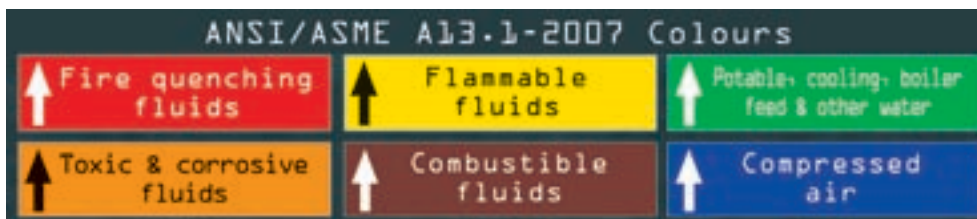

Roll Size	Black/Yellow Model No.	Mfg No.	White/Green Model No.	Mfg No.	White/Blue Model No.	Mfg No.	Price /Roll
1" x 54'	SAW353	RAW252BKYL	SAW356	RAW252GNWT	SAW359	RAW252BUWT	27.30
2" x 54'	SAW354	RAW254BKYL	SAW357	RAW254GNWT	SAW360	RAW254BUWT	37.40
4" x 54'	SAW355	RAW258BKYL	SAW358	RAW258GNWT	SAW361	RAW258BUWT	69.40

Roll Size	White/Red Model No.	Mfg No.	White/Brown Model No.	Mfg No.	Black/Orange Model No.	Mfg No.	Price /Roll
1" x 54'	SAW362	RAW252RDWT	SAW365	RAW252WTBR	SAW368	RAW252BKOR	27.30
2" x 54'	SAW363	RAW254RDWT	SAW366	RAW254WTBR	SAW369	RAW254BKOR	37.40
4" x 54'	SAW364	RAW258RDWT	SAW367	RAW258WTBR	SAW370	RAW258BKOR	69.40



## COLOUR BANDING PIPE MARKING TAPES

- Available in a variety of colours and are ideal for coding pipes
- 6-mil colour tapes have self-adhesive back and are self-wound in rolls with no peel-off liner
- Apply tape to clean, smooth, dry surface
- Service temperature range is -20° to 140°F
- Waterproof and wear-resistant



Roll Size	Red Model No.	Mfg No.	Green Model No.	Mfg No.	Blue Model No.	Mfg No.	Gray Model No.	Mfg No.	Brown Model No.	Mfg No.	Price /Roll
1" x 108'	SAW389	PTM613RD	SAW392	PTM613GN	SAW395	PTM613BU	SAW398	PTM613GY	SAW401	PTM613BN	10.00
2" x 108'	SAW390	PTM623RD	SAW393	PTM623GN	SAW396	PTM623BU	SAW399	PTM623GY	SAW402	PTM623BN	18.60
3" x 108'	SAW391	PTM633RD	SAW394	PTM633GN	SAW397	PTM633BU	SAW400	PTM633GY	SAW403	PTM633BN	27.00

Roll Size	Black Model No.	Mfg No.	Yellow Model No.	Mfg No.	Orange Model No.	Mfg No.	White Model No.	Mfg No.	Purple Model No.	Mfg No.	Price /Roll
1" x 108'	SAW404	PTM613BK	SAW407	PTM613YL	SAW410	PTM613OR	SAW413	PTM613WT	SAW416	PTM613PR	10.00
2" x 108'	SAW405	PTM623BK	SAW408	PTM623YL	SAW411	PTM623OR	SAW414	PTM623WT	SAW417	PTM623PR	18.60
3" x 108'	SAW406	PTM633BK	SAW409	PTM633YL	SAW412	PTM633OR	SAW415	PTM633WT	SAW418	PTM633PR	27.00

IF YOU DO NOT SEE THE SIZE YOU ARE LOOKING FOR PLEASE CALL US!

# LABELLING SYSTEMS & SUPPLIES



## SELF-STICK VINYL PIPE MARKERS

Adhere self-stick pipe markers to clearly identify the pipe contents and flow direction.

- Bold, single legend on contrasting colour
- Included arrow\* provides proper directional flow marking
- 4-mil flexible vinyl marker has UV-resistant polyester overlaminated with high-tack, acrylic adhesive back
- Durable, protective gloss surface withstands fading, abrasions, splashes, grease, dust, and dirt that wipes off
- Easy to install by peeling off back liner, apply to a smooth, clean pipe surface - align and press firmly into place.
- Service temperature is -40° to 176°F

Available per each.



\*Directional flow arrow tapes are also available (sold separately) to increase the visibility by banding around the pipe and hold the marker in place.

## SNAP TITE™ PIPE MARKERS

It's a 'SNAP' to wrap around and identify contents in pipes with the flow direction. Snap Tite™ is pre-coiled to install quickly and easily - simply uncurl over the pipe, release it, and it 'SNAPS' into place.

- 360° coverage encircles the pipe for marker to be seen from virtually any angle
- Bold legend and directional flow arrow on contrasting colour is repeated upright and upside-down, for universal direction fit and visibility
- Heavy gauge 20-mil rigid vinyl plastic is lightweight, yet durable to withstand tough industrial environments
- Fits over pipes with dirty, greasy, or rough surfaces – even over insulation or other less than perfect surfaces, and easy to remove and reapply
- Service temperature range is -4° to 158°F

Available per each.



Not recommended for hot pipes.

Self Stick Vinyl Pipe Markers				Pipe Marker Legend	Snap Tite™ Pipe Markers				
Style SSA	Style SSB	Style SSD	Style SSH		Style STA	Style STB	Style STC	Style STE	Style STF
SAV229	SAV230	SAV231	SAV232	ACETONE	SAV613	SAV614	SAV615	SAV616	SAV617
SAV233	SAV234	SH426	SH425	ACETYLENE GAS	SAV618	SAV619	SAV620	SAV621	SAV622
SAV235	SAV236	SAV237	SAV238	ACID	SAV623	SAV624	SAV625	SAV626	SAV627
SAV239	SAV240	SH438	SH437	ACID WASTE	SAV628	SAV629	SAV630	SAV631	SAV632
SAV241	SAV242	SH450	SH449	AIR	SAV633	SAV634	SAV635	SAV636	SAV637
SAV243	SAV244	SH446	SH445	AIR	SAV638	SAV639	SAV640	SAV641	SAV642
SAV245	SAV246	SH442	SH441	AIR	SAV643	SAV644	SAV645	SAV646	SAV647
SAV247	SAV248	SH462	SH461	AIR SUPPLY	SAV648	SAV649	SAV650	SAV651	SAV652
SAV249	SAV250	SH470	SH469	ALCOHOL	SAV653	SAV654	SAV655	SAV656	SAV657
SAV251	SAV252	SH478	SH477	AMMONIA	SAV658	SAV659	SAV660	SAV661	SAV662
SAV253	SAV254	SAV255	SAV256	ARGON	SAV663	SAV664	SAV665	SAV666	SAV667
SAV257	SAV258	SAV259	SAV260	ARGON	SAV668	SAV669	SAV670	SAV671	SAV672
SAV261	SAV262	SH494	SH493	ASBESTOS FREE INSULATION	SAV673	SAV674	SAV675	SAV676	SAV677
SAV263	SAV264	SAV265	SAV266	BOILER DRAIN	SAV678	SAV679	SAV680	SAV681	SAV682
SAV267	SAV268	SAV269	SAV270	BOILER FEED	SAV683	SAV684	SAV685	SAV686	SAV687
SAV271	SAV272	SAV273	SAV274	BOILER FEED WATER	SAV688	SAV689	SAV690	SAV691	SAV692
SAV275	SAV276	SAV277	SAV278	BREATHING AIR	SAV693	SAV694	SAV695	SAV696	SAV697
SAV279	SAV280	SH570	SH569	CARBON DIOXIDE	SAV698	SAV699	SAV700	SAV701	SAV702

### SELF-STICK

Style Code	Pipe Diameter"	Marker Size"	Letter Height"	Price/Each
SSA	3/4 to 1 1/4	1 x 8	1/2	3.12
SSB	1 1/2 to 2	1 1/2 x 8	3/4	3.29
SSD	2 1/2 to 6	2 1/2 x 12	1 1/4	4.01
SSH	8 to 10	4 x 24	2 1/2	10.10

### SNAP TITE™

Style Code	Pipe Diameter"	Marker Size"	Letter Height"	Price/Each
STA	3/4 to 1 1/4	6 x 8	1/2	7.36
STB	1 1/2 to 2	9 x 8	3/4	9.72
STC	2 1/4 to 3	14 x 12	1 1/4	18.10
STE	3 1/4 to 5	19 x 12*	1 1/4	20.00
STF	5 1/4 to 6	25 x 12*	1 1/4	20.70

\*Styles STE and STF have self-adhesive leading edge for a secure fit.

IF YOU DO NOT SEE THE LEGEND OR SIZE YOU ARE LOOKING FOR PLEASE CALL US!

# LABELLING SYSTEMS & SUPPLIES

## ENGLISH LABELS

Self Stick Vinyl Pipe Markers				Pipe Marker Legend	Snap Tite™ Pipe Markers				
Style SSA	Style SSB	Style SSD	Style SSH		Style STA	Style STB	Style STC	Style STE	Style STF
SAV281	SAV282	SAV283	SAV284	<b>CAUSTIC</b>	SAV703	SAV704	SAV705	SAV706	SAV707
SAV285	SAV286	SH582	SH581	<b>CAUSTIC SODA</b>	SAV708	SAV709	SAV710	SAV711	SAV712
SAV287	SAV288	SH586	SH585	<b>CHEMICAL</b>	SAV713	SAV714	SAV715	SAV716	SAV717
SAV289	SAV290	SH598	SH597	<b>CHILLED WATER</b>	SAV718	SAV719	SAV720	SAV721	SAV722
SAV291	SAV292	SBB333	SH601	<b>CHILLED WATER RETURN</b>	SAV723	SAV724	SAV725	SAV726	SAV727
SAV293	SAV294	SBB334	SH605	<b>CHILLED WATER SUPPLY</b>	SAV728	SAV729	SAV730	SAV731	SAV732
SAV295	SAV296	SH630	SH629	<b>CITY GAS</b>	SAV733	SAV734	SAV735	SAV736	SAV737
SAV297	SAV298	SH634	SH633	<b>CITY WATER</b>	SAV738	SAV739	SAV740	SAV741	SAV742
SAV299	SAV300	SH638	SH637	<b>COLD WATER</b>	SAV743	SAV744	SAV745	SAV746	SAV747
SAV301	SAV302	SH646	SH645	<b>COLD WATER SUPPLY</b>	SAV748	SAV749	SAV750	SAV751	SAV752
SAV303	SAV304	SH650	SH649	<b>COMPRESSED AIR</b>	SAV753	SAV754	SAV755	SAV756	SAV757
SAV305	SAV306	SH658	SH657	<b>COMPRESSED AIR</b>	SAV758	SAV759	SAV760	SAV761	SAV762
SAV307	SAV308	SH662	SH661	<b>CONDENSATE</b>	SAV763	SAV764	SAV765	SAV766	SAV767
SAV309	SAV310	SAV311	SAV312	<b>CONDENSATE DRAIN</b>	SAV768	SAV769	SAV770	SAV771	SAV772
SAV313	SAV314	SH678	SH677	<b>CONDENSATE RETURN</b>	SAV773	SAV774	SAV775	SAV776	SAV777
SAV315	SAV316	SAV317	SAV318	<b>CONDENSATE SUPPLY</b>	SAV778	SAV779	SAV780	SAV781	SAV782
SAV319	SAV320	SH698	SH697	<b>COOLING WATER</b>	SAV783	SAV784	SAV785	SAV786	SAV787
SAV321	SAV322	SH702	SH701	<b>COOLING WATER RETURN</b>	SAV788	SAV789	SAV790	SAV791	SAV792
SAV323	SAV324	SAV325	SAV326	<b>COOLING WATER SUPPLY</b>	SAV793	SAV794	SAV795	SAV796	SAV797
SAV327	SAV328	SH710	SH709	<b>DEIONIZED WATER</b>	SAV798	SAV799	SAV800	SAV801	SAV802
SAV329	SAV330	SH730	SH729	<b>DIESEL OIL</b>	SAV803	SAV804	SAV805	SAV806	SAV807
SAV331	SAV332	SAV333	SAV334	<b>DISCHARGE</b>	SAV808	SAV809	SAV810	SAV811	SAV812
SAV335	SAV336	SH754	SH753	<b>DOMESTIC COLD WATER</b>	SAV813	SAV814	SAV815	SAV816	SAV817
SAV337	SAV338	SH766	SH765	<b>DOMESTIC HOT WATER</b>	SAV818	SAV819	SAV820	SAV821	SAV822
SAV339	SAV340	SAV341	SAV342	<b>DOMESTIC HOT WATER RECIRCULATION</b>	SAV823	SAV824	SAV825	SAV826	SAV827
SAV343	SAV344	SH770	SH769	<b>DOMESTIC HOT WATER RETURN</b>	SAV828	SAV829	SAV830	SAV831	SAV832
SAV345	SAV346	SH774	SH773	<b>DOMESTIC HOT WATER SUPPLY</b>	SAV833	SAV834	SAV835	SAV836	SAV837
SAV347	SAV348	SH782	SH781	<b>DRAIN</b>	SAV838	SAV839	SAV840	SAV841	SAV842
SAV349	SAV350	SH790	SH805	<b>DRINKING WATER</b>	SAV843	SAV844	SAV845	SAV846	SAV847
SAV351	SAV352	SH802	SH801	<b>ELECTRIC TRACED</b>	SAV848	SAV849	SAV850	SAV851	SAV852
SAV353	SAV354	SH818	SH817	<b>EXHAUST AIR</b>	SAV853	SAV854	SAV855	SAV856	SAV857
SAV355	SAV356	SBB335	SH857	<b>FIRE PROTECTION WATER</b>	SAV858	SAV859	SAV860	SAV861	SAV862
SAV357	SAV358	SAV359	SAV360	<b>FIRE SPRINKLER WATER</b>	SAV863	SAV864	SAV865	SAV866	SAV867
SAV361	SAV362	SH866	SH865	<b>FREON</b>	SAV868	SAV869	SAV870	SAV871	SAV872
SAV363	SAV364	SH870	SH869	<b>FRESH WATER</b>	SAV873	SAV874	SAV875	SAV876	SAV877
SAV365	SAV366	SH874	SH873	<b>FUEL GAS</b>	SAV878	SAV879	SAV880	SAV881	SAV882
SAV367	SAV368	SH878	SH877	<b>FUEL OIL</b>	SAV883	SAV884	SAV885	SAV886	SAV887
SAV369	SAV370	SH882	SH881	<b>FUEL OIL RETURN</b>	SAV888	SAV889	SAV890	SAV891	SAV892



### SELF-STICK

Size Code	Pipe Diameter"	Marker Size"	Letter Height"	Price/Each
SSA	3/4 to 1 1/4	1 x 8	1/2	3.12
SSB	1 1/2 to 2	1 1/2 x 8	3/4	3.29
SSD	2 1/2 to 6	2 1/2 x 12	1 1/4	4.01
SSH	8 to 10	4 x 24	2 1/2	10.10

### SNAP TITE™

Size Code	Pipe Diameter"	Marker Size"	Letter Height"	Price/Each
STA	3/4 to 1 1/4	6 x 8	1/2	7.36
STB	1 1/2 to 2	9 x 8	3/4	9.72
STC	2 1/4 to 3	14 x 12	1 1/4	18.10
STE	3 1/4 to 5	19 x 12*	1 1/4	20.00
STF	5 1/4 to 6	25 x 12*	1 1/4	20.70

\*Sizes STE and STF have self-adhesive leading edge for a secure fit.

IF YOU DO NOT SEE THE LEGEND OR SIZE YOU ARE LOOKING FOR PLEASE CALL US!

# LABELLING SYSTEMS & SUPPLIES



## ENGLISH LABELS

Self Stick Vinyl Pipe Markers				Pipe Marker Legend	Snap Tite™ Pipe Markers				
Style SSA	Style SSB	Style SSD	Style SSH		Style STA	Style STB	Style STC	Style STE	Style STF
SAV371	SAV372	SH886	SH885	FUEL OIL SUPPLY	SAV893	SAV894	SAV895	SAV896	SAV897
SAV373	SAV374	SH894	SH893	GAS	SAV898	SAV899	SAV900	SAV901	SAV902
SAV375	SAV376	SAV377	SAV378	GASOLINE	SAV903	SAV904	SAV905	SAV906	SAV907
SAV379	SAV380	SH902	SH901	GLYCOL	SAV908	SAV909	SAV910	SAV911	SAV912
SAV381	SAV382	SH906	SH905	GLYCOL RETURN	SAV913	SAV914	SAV915	SAV916	SAV917
SAV383	SAV384	SH910	SH909	GLYCOL SUPPLY	SAV918	SAV919	SAV920	SAV921	SAV922
SAV385	SAV386	SH918	SH917	HEATING RETURN	SAV923	SAV924	SAV925	SAV926	SAV927
SAV387	SAV388	SH926	SH925	HEATING SUPPLY	SAV928	SAV929	SAV930	SAV931	SAV932
SAV389	SAV390	SH962	SH961	HIGH PRESSURE CONDENSATE	SAV933	SAV934	SAV935	SAV936	SAV937
SAV391	SAV392	SH966	SH965	HIGH PRESSURE GAS	SAV938	SAV939	SAV940	SAV941	SAV942
SAV393	SAV394	SH970	SH969	HIGH PRESSURE NATURAL GAS	SAV943	SAV944	SAV945	SAV946	SAV947
SAV395	SAV396	SBB336	SH977	HIGH PRESSURE STEAM	SAV948	SAV949	SAV950	SAV951	SAV952
SAV397	SAV398	SH990	SH989	HOT	SAV953	SAV954	SAV955	SAV956	SAV957
SAV399	SAV400	SAV401	SAV402	HOT WATER	SAV958	SAV959	SAV960	SAV961	SAV962
SAV403	SAV404	SH998	SH997	HOT WATER	SAV963	SAV964	SAV965	SAV966	SAV967
SAV405	SAV406	SI007	SI006	HOT WATER RETURN	SAV968	SAV969	SAV970	SAV971	SAV972
SAV407	SAV408	SI011	SI010	HOT WATER SUPPLY	SAV973	SAV974	SAV975	SAV976	SAV977
SAV409	SAV410	SAV411	SAV412	HYDRAULIC FLUID	SAV978	SAV979	SAV980	SAV981	SAV982
SAV413	SAV414	SAV415	SAV416	HYDRAULIC LINE	SAV983	SAV984	SAV985	SAV986	SAV987
SAV417	SAV418	SAV419	SAV420	HYDRAULIC OIL	SAV988	SAV989	SAV990	SAV991	SAV992
SAV421	SAV422	SI039	SI038	HYDROCHLORIC ACID	SAV993	SAV994	SAV995	SAV996	SAV997
SAV423	SAV424	SI043	SI042	HYDROGEN	SAV998	SAV999	SAW001	SAW002	SAW003
SAV425	SAV426	SI047	SI046	HYDROGEN PEROXIDE	SAW004	SAW005	SAW006	SAW007	SAW008
SAV427	SAV428	SAV429	SAV430	INDUSTRIAL WATER	SAW009	SAW010	SAW011	SAW012	SAW013
SAV431	SAV432	SAV433	SAV434	INSTRUMENT AIR	SAW014	SAW015	SAW016	SAW017	SAW018
SAV435	SAV436	SAV437	SAV438	INSTRUMENT AIR	SAW019	SAW020	SAW021	SAW022	SAW023
SAV439	SAV440	SAV441	SAV442	LIQUID NITROGEN	SAW024	SAW025	SAW026	SAW027	SAW028
SAV443	SAV444	SI115	SI114	LOW PRESSURE CONDENSATE	SAW029	SAW030	SAW031	SAW032	SAW033
SAV445	SAV446	SI123	SI122	LOW PRESSURE NATURAL GAS	SAW034	SAW035	SAW036	SAW037	SAW038
SAV447	SAV448	SI131	SI130	LOW PRESSURE STEAM	SAW039	SAW040	SAW041	SAW042	SAW043
SAV449	SAV450	SI139	SI138	LUBE OIL	SAW044	SAW045	SAW046	SAW047	SAW048
SAV451	SAV452	SAV453	SAV454	MED-PRESSURE STEAM	SAW049	SAW050	SAW051	SAW052	SAW053
SAV455	SAV456	SAV457	SAV458	MIXED GAS	SAW054	SAW055	SAW056	SAW057	SAW058
SAV459	SAV460	SBB338	SI182	NATURAL GAS	SAW059	SAW060	SAW061	SAW062	SAW063
SAV461	SAV462	SI195	SI194	NITROGEN	SAW064	SAW065	SAW066	SAW067	SAW068
SAV463	SAV464	SI191	SI190	NITROGEN	SAW069	SAW070	SAW071	SAW072	SAW073
SAV465	SAV466	SI203	SI202	NON-POTABLE WATER	SAW074	SAW075	SAW076	SAW077	SAW078
SAV467	SAV468	SI207	SI206	OIL	SAW079	SAW080	SAW081	SAW082	SAW083



### SELF-STICK

Size Code	Pipe Diameter"	Marker Size"	Letter Height"	Price/Each
SSA	3/4 to 1 1/4	1 x 8	1/2	3.12
SSB	1 1/2 to 2	1 1/2 x 8	3/4	3.29
SSD	2 1/2 to 6	2 1/2 x 12	1 1/4	4.01
SSH	8 to 10	4 x 24	2 1/2	10.10

### SNAP TITE™

Size Code	Pipe Diameter"	Marker Size"	Letter Height"	Price/Each
STA	3/4 to 1 1/4	6 x 8	1/2	7.36
STB	1 1/2 to 2	9 x 8	3/4	9.72
STC	2 1/4 to 3	14 x 12	1 1/4	18.10
STE	3 1/4 to 5	19 x 12*	1 1/4	20.00
STF	5 1/4 to 6	25 x 12*	1 1/4	20.70

\*Sizes STE and STF have self-adhesive leading edge for a secure fit.

IF YOU DO NOT SEE THE LEGEND OR SIZE YOU ARE LOOKING FOR PLEASE CALL US!



# LABELLING SYSTEMS & SUPPLIES

## ENGLISH LABELS

Self Stick Vinyl Pipe Markers				Pipe Marker Legend	Snap Tite™ Pipe Markers				
Style SSA	Style SSB	Style SSD	Style SSH		Style STA	Style STB	Style STC	Style STE	Style STF
SAV469	SAV470	SI227	SI226	<b>OXYGEN</b>	SAW084	SAW085	SAW086	SAW087	SAW088
SAV471	SAV472	SAV473	SAV474	<b>OXYGEN</b>	SAW089	SAW090	SAW091	SAW092	SAW093
SAV475	SAV476	SI231	SI230	<b>OXYGEN</b>	SAW094	SAW095	SAW096	SAW097	SAW098
SAV477	SAV478	SAV479	SAV480	<b>PLANT AIR</b>	SAW099	SAW100	SAW101	SAW102	SAW103
SAV481	SAV482	SI239	SI238	<b>PLANT WATER</b>	SAW104	SAW105	SAW106	SAW107	SAW108
SAV483	SAV484	SAV485	SAV486	<b>PLUMBING VENT</b>	SAW109	SAW110	SAW111	SAW112	SAW113
SAV487	SAV488	SI247	SI246	<b>POLYMER</b>	SAW114	SAW115	SAW116	SAW117	SAW118
SAV489	SAV490	SI263	SI262	<b>POTABLE WATER</b>	SAW119	SAW120	SAW121	SAW122	SAW123
SAV491	SAV492	SAV493	SAV494	<b>PROCESS WATER</b>	SAW124	SAW125	SAW126	SAW127	SAW128
SAV495	SAV496	SI283	SI282	<b>PROCESS WATER</b>	SAW129	SAW130	SAW131	SAW132	SAW133
SAV497	SAV498	SI295	SI294	<b>PROPANE GAS</b>	SAW134	SAW135	SAW136	SAW137	SAW138
SAV499	SAV500	SI303	SI302	<b>RAINWATER</b>	SAW139	SAW140	SAW141	SAW142	SAW143
SAV501	SAV502	SAV503	SAV504	<b>RAW WATER</b>	SAW144	SAW145	SAW146	SAW147	SAW148
SAV505	SAV506	SI363	SI362	<b>RETURN</b>	SAW149	SAW150	SAW151	SAW152	SAW153
SAV507	SAV508	SI355	SI354	<b>RETURN</b>	SAW154	SAW155	SAW156	SAW157	SAW158
SAV509	SAV510	SI375	SI374	<b>ROOF DRAIN</b>	SAW159	SAW160	SAW161	SAW162	SAW163
SAV511	SAV512	SI383	SI382	<b>SANITARY DRAIN</b>	SAW164	SAW165	SAW166	SAW167	SAW168
SAV513	SAV514	SAV515	SAV516	<b>SANITARY SEWER</b>	SAW169	SAW170	SAW171	SAW172	SAW173
SAV517	SAV518	SAV519	SAV520	<b>SANITARY VENT</b>	SAW174	SAW175	SAW176	SAW177	SAW178
SAV521	SAV522	SAV523	SAV524	<b>SERVICE AIR</b>	SAW179	SAW180	SAW181	SAW182	SAW183
SAV525	SAV526	SI443	SI442	<b>SODIUM HYPOCHLORITE</b>	SAW184	SAW185	SAW186	SAW187	SAW188
SAV527	SAV528	SI447	SI446	<b>SOFT WATER</b>	SAW189	SAW190	SAW191	SAW192	SAW193
SAV529	SAV530	SI455	SI454	<b>SPRINKLER</b>	SAW194	SAW195	SAW196	SAW197	SAW198
SAV531	SAV532	SI459	SI458	<b>SPRINKLER FIRE</b>	SAW199	SAW200	SAW201	SAW202	SAW203
SAV533	SAV534	SI463	SI462	<b>SPRINKLER WATER</b>	SAW204	SAW205	SAW206	SAW207	SAW208
SAV535	SAV536	SI467	SI466	<b>STEAM</b>	SAW209	SAW210	SAW211	SAW212	SAW213
SAV537	SAV538	SI471	SI470	<b>STEAM RETURN</b>	SAW214	SAW215	SAW216	SAW217	SAW218
SAV539	SAV540	SI475	SI474	<b>STEAM SUPPLY</b>	SAW219	SAW220	SAW221	SAW222	SAW223
SAV541	SAV542	SI487	SI486	<b>STORM WATER</b>	SAW224	SAW225	SAW226	SAW227	SAW228
SAV543	SAV544	SI503	SI502	<b>SULFURIC ACID</b>	SAW229	SAW230	SAW231	SAW232	SAW233
SAV545	SAV546	SAV547	SAV548	<b>SUPPLY</b>	SAW234	SAW235	SAW236	SAW237	SAW238
SAV549	SAV550	SI515	SI514	<b>SUPPLY</b>	SAW239	SAW240	SAW241	SAW242	SAW243
SAV551	SAV552	SI531	SI530	<b>TOWER WATER RETURN</b>	SAW244	SAW245	SAW246	SAW247	SAW248
SAV553	SAV554	SI535	SI534	<b>TOWER WATER SUPPLY</b>	SAW249	SAW250	SAW251	SAW252	SAW253
SAV555	SAV556	SI543	SI542	<b>TREATED WATER</b>	SAW254	SAW255	SAW256	SAW257	SAW258
SAV557	SAV558	SI551	SI550	<b>VACUUM</b>	SAW259	SAW260	SAW261	SAW262	SAW263
SAV559	SAV560	SI555	SI554	<b>VACUUM</b>	SAW264	SAW265	SAW266	SAW267	SAW268
SAV561	SAV562	SI567	SI566	<b>VENT</b>	SAW269	SAW270	SAW271	SAW272	SAW273



### SELF-STICK

Size Code	Pipe Diameter"	Marker Size"	Letter Height"	Price/Each
SSA	3/4 to 1 1/4	1 x 8	1/2	3.12
SSB	1 1/2 to 2	1 1/2 x 8	3/4	3.29
SSD	2 1/2 to 6	2 1/2 x 12	1 1/4	4.01
SSH	8 to 10	4 x 24	2 1/2	10.10

### SNAP TITE™

Size Code	Pipe Diameter"	Marker Size"	Letter Height"	Price/Each
STA	3/4 to 1 1/4	6 x 8	1/2	7.36
STB	1 1/2 to 2	9 x 8	3/4	9.72
STC	2 1/4 to 3	14 x 12	1 1/4	18.10
STE	3 1/4 to 5	19 x 12*	1 1/4	20.00
STF	5 1/4 to 6	25 x 12*	1 1/4	20.70

\*Sizes STE and STF have self-adhesive leading edge for a secure fit.

IF YOU DO NOT SEE THE LEGEND OR SIZE YOU ARE LOOKING FOR PLEASE CALL US!

# LABELLING SYSTEMS & SUPPLIES



## ENGLISH LABELS

Self Stick Vinyl Pipe Markers				Pipe Marker Legend	Snap Tite™ Pipe Markers				
Style SSA	Style SSB	Style SSD	Style SSH		Style STA	Style STB	Style STC	Style STE	Style STF
SAV563	SAV564	SI571	SI570	<b>VENT</b>	SAW274	SAW275	SAW276	SAW277	SAW278
SAV565	SAV566	SAV567	SAV568	<b>WASTE</b>	SAW279	SAW280	SAW281	SAW282	SAW283
SAV569	SAV570	SAV571	SAV572	<b>WASTE WATER</b>	SAW284	SAW285	SAW286	SAW287	SAW288
SAV573	SAV574	SI591	SI590	<b>WASTE WATER</b>	SAW289	SAW290	SAW291	SAW292	SAW293
SAV575	SAV576	SI603	SI602	<b>WATER</b>	SAW294	SAW295	SAW296	SAW297	SAW298
SAV577	SAV578	SI599	SI598	<b>WATER</b>	SAW299	SAW300	SAW301	SAW302	SAW303
SAV579	SAV580	SI607	SI606	<b>WELL WATER</b>	SAW304	SAW305	SAW306	SAW307	SAW308
SAV581	SAV582	SAV583	SAV584		SAW309	SAW310	SAW311	SAW312	SAW313
SAV585	SAV586	SAV587	SAV588		SAW314	SAW315	SAW316	SAW317	SAW318
SAV589	SAV590	SAV591	SAV592		SAW319	SAW320	SAW321	SAW322	SAW323
SAV593	SAV594	SAV595	SAV596		SAW324	SAW325	SAW326	SAW327	SAW328
SAV597	SAV598	SAV599	SAV600		SAW329	SAW330	SAW331	SAW332	SAW333
SAV601	SAV602	SAV603	SAV604		SAW334	SAW335	SAW336	SAW337	SAW338
SAV605	SAV606	SAV607	SAV608		SAW339	SAW340	SAW341	SAW342	SAW343
SAV609	SAV610	SAV611	SAV612		SAW344	SAW345	SAW346	SAW347	SAW348



## SELF-STICK

Size Code	Pipe Diameter"	Marker Size"	Letter Height"	Price/Each
SSA	3/4 to 1 1/4	1 x 8	1/2	3.12
SSB	1 1/2 to 2	1 1/2 x 8	3/4	3.29
SSD	2 1/2 to 6	2 1/2 x 12	1 1/4	4.01
SSH	8 to 10	4 x 24	2 1/2	10.10

## SNAP TITE™

Size Code	Pipe Diameter"	Marker Size"	Letter Height"	Price/Each
STA	3/4 to 1 1/4	6 x 8	1/2	7.36
STB	1 1/2 to 2	9 x 8	3/4	9.72
STC	2 1/4 to 3	14 x 12	1 1/4	18.10
STE	3 1/4 to 5	19 x 12*	1 1/4	20.00
STF	5 1/4 to 6	25 x 12*	1 1/4	20.70

\*Sizes STE and STF have self-adhesive leading edge for a secure fit.

## CUSTOM PIPE MARKERS MADE EASY!

- No set-up fees
- Any print colors
- Full-color graphics and images, including design, image, and logo
- Choose a message with any letter font
- Available barcoding, numbering, and other coding features – Call us for details



ACCUFORM®



## HOW TO ORDER CUSTOM PIPE MARKERS

### STEP 1: MATERIAL AND SIZE

Measure the pipe outside diameter, including insulation, to determine proper size

### STEP 2: COLOR COMBINATION

Refer to the ASME color guide or choose your own color combination

### STEP 3: LEGEND

Specify your desired marker legend, and include directional flow arrows, if they apply

### STEP 4: QUANTITY

There are no set-up costs or minimums!

Black on Orange
White on Green
White on Red
Black on Yellow
White on Blue
White on Brown

ASME Colors

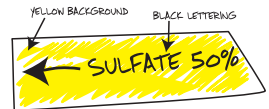

## SELF STICK VINYL

- 4-mil flexible vinyl with 2-mil overlaminated
- UV resistant polyester film withstands elements
- High-tack, acrylic adhesive back and peel-off liner
- Directional flow arrow marker included
- Price per each



Fit Pipe Diameter	Marker Size	
3/4" to 1 1/4"	1" x 8"	<b>CALL FOR PRICING</b>
1 1/2" to 2"	1 1/2" x 8"	
2 1/2" to 6"	2 1/2" x 12"	
8" to 10"	4" x 24"	
Over 10"	4 1/2" x 32"	
Other Size		

## SNAP TITE™

- Pre-coiled design 'snaps' around to fit 360° over pipe
- 20-mil rigid vinyl with repeating message and directional arrow
- Ideal for irregular surfaces, insulated pipes, or where removal is necessary
- Not recommended for hot pipes
- Price per each

Fit Pipe Diameter	Marker Size	
Up to 1/4"	2" x 4"	<b>CALL FOR PRICING</b>
Up to 1/2"	4" x 6"	
3/4" to 1 1/4"	6" x 8"	
1 1/2" to 2"	9" x 8"	
2 1/4" to 3"	14" x 12"	
3 1/4" to 5"	19" x 12**	
5-1/4" to 6"	25" x 12**	

\*Comes with self-adhesive leading edge



# LABELLING SYSTEMS & SUPPLIES

## FRENCH LABELS

Self Stick Vinyl Pipe Markers				Pipe Marker Legend	Snap Tite™ Pipe Markers				
Style SSA	Style SSB	Style SSD	Style SSH		Style STA	Style STB	Style STC	Style STE	Style STF
SAY902	SAY903	SQ300	SAH018	ACIDE CHLORHYDRIQUE	SAZ086	SAZ087	SAZ088	SAZ089	SAZ090
SAY904	SAY905	SQ302	SAH020	ACIDE NITRIQUE	SAZ091	SAZ092	SAZ093	SAZ094	SAZ095
SAY906	SAY907	SQ306	SAH022	ACIDE SULFURIQUE	SAZ096	SAZ097	SAZ098	SAZ099	SAZ100
SAY908	SAY909	SQ310	SAH024	AIR	SAZ101	SAZ102	SAZ103	SAZ104	SAZ105
SAY910	SAY911	SQ313	SAH025	AIR	SAZ106	SAZ107	SAZ108	SAZ109	SAZ110
SAY912	SAY913	SQ315	SAH027	AIR	SAZ111	SAZ112	SAZ113	SAZ114	SAZ115
SAY914	SAY915	SQ328	SAH036	AIR COMPRIMÉ	SAZ116	SAZ117	SAZ118	SAZ119	SAZ120
SAY916	SAY917	SQ331	SAH037	AIR COMPRIMÉ	SAZ121	SAZ122	SAZ123	SAZ124	SAZ125
SAY918	SAY919	SQ334	SAH038	AIR COMPRIMÉ	SAZ126	SAZ127	SAZ128	SAZ129	SAZ130
SAY920	SAY921	SQ370	SAH066	ALIMENTATION	SAZ131	SAZ132	SAZ133	SAZ134	SAZ135
SAY922	SAY923	SQ372	SAH068	ALIMENTATION	SAZ136	SAZ137	SAZ138	SAZ139	SAZ140
SAY924	SAY925	SQ375	SQ374	ALIMENTATION	SAZ141	SAZ142	SAZ143	SAZ144	SAZ145
SAY926	SAY927	SQ380	SAH072	ALIMENTATION DE CHAUDIÈRE	SAZ146	SAZ147	SAZ148	SAZ149	SAZ150
SAY928	SAY929	SQ386	SAH078	ALIM. DE REFOUILLAGE	SAZ151	SAZ152	SAZ153	SAZ154	SAZ155
SAY930	SAY931	SQ392	SAH088	ALIMENTATION EN EAU CHAUDE	SAZ156	SAZ157	SAZ158	SAZ159	SAZ160
SAY932	SAY933	SQ395	SQ394	ALIM. EN EAU DE CHAUFFAGE	SAZ161	SAZ162	SAZ163	SAZ164	SAZ165
SAY934	SAY935	SQ402	SAH094	ALIM. EN EAU FROIDE	SAZ166	SAZ167	SAZ168	SAZ169	SAZ170
SAY936	SAY937	SQ407	SQ406	ALIM. D'EAU RÉFRIGÉRÉE	SAZ171	SAZ172	SAZ173	SAZ174	SAZ175
SAY938	SAY939	SQ409	SAH099	ALIMENTATION EN GLYCOL	SAZ176	SAZ177	SAZ178	SAZ179	SAZ180
SAY940	SAY941	SQ411	SAH101	ALIMENTATION EN MAZOUT	SAZ181	SAZ182	SAZ183	SAZ184	SAZ185
SAY942	SAY943	SQ415	SAH105	ALIMENTATION HYDRAULIQUE	SAZ186	SAZ187	SAZ188	SAZ189	SAZ190
SAY944	SAY945	SQ425	SAH115	ASPIRATION DE RÉFRIGÉRANT	SAZ191	SAZ192	SAZ193	SAZ194	SAZ195
SAY946	SAY947	SQ427	SAH117	ARGON	SAZ196	SAZ197	SAZ198	SAZ199	SAZ200
SAY948	SAY949	SQ430	SAH118	ARGON	SAZ201	SAZ202	SAZ203	SAZ204	SAZ205
SAY950	SAY951	SQ438	SAH121	AZOTE	SAZ206	SAZ207	SAZ208	SAZ209	SAZ210
SAY952	SAY953	SQ441	SAH122	AZOTE	SAZ211	SAZ212	SAZ213	SAZ214	SAZ215
SAY954	SAY955	SQ450	SAH129	BASSE PRESSION	SAZ216	SAZ217	SAZ218	SAZ219	SAZ220
SAY956	SAY957	SQ473	SAH141	CARBURANT DIESEL	SAZ221	SAZ222	SAZ223	SAZ224	SAZ225
SAY958	SAY959	SQ476	SAH142	CAUSTIQUE	SAZ226	SAZ227	SAZ228	SAZ229	SAZ230
SAY960	SAY961	SQ490	SAH148	CHLORE	SAZ231	SAZ232	SAZ233	SAZ234	SAZ235
SAY962	SAY963	SQ503	SQ502	CONDENSÉ	SAZ236	SAZ237	SAZ238	SAZ239	SAZ240
SAY964	SAY965	SQ506	SBA683	CONDENSATS À BASSE PRESSION	SAZ241	SAZ242	SAZ243	SAZ244	SAZ245
SAY966	SAY967	SQ531	SQ530	DESCENTE D'EAUX PLUVIALES	SAZ246	SAZ247	SAZ248	SAZ249	SAZ250
SAY968	SAY969	SQ556	SAH179	DRAIN DE CONSENSAT	SAZ251	SAZ252	SAZ253	SAZ254	SAZ255
SAY970	SAY971	SQ558	SAH181	DRAIN DE CONSENSAT	SAZ256	SAZ257	SAZ258	SAZ259	SAZ260
SAY972	SAY973	SQ567	SAH185	EAU	SAZ261	SAZ262	SAZ263	SAZ264	SAZ265
SAY974	SAY975	SQ571	SQ570	EAU	SAZ266	SAZ267	SAZ268	SAZ269	SAZ270



### SELF-STICK

Size Code	Pipe Diameter"	Marker Size"	Letter Height"	Price/Each
SSA	3/4 to 1 1/4	1 x 8	1/2	3.12
SSB	1 1/2 to 2	1 1/2 x 8	3/4	3.29
SSD	2 1/2 to 6	2 1/2 x 12	1 1/4	4.01
SSH	8 to 10	4 x 24	2 1/2	10.10

### SNAP TITE™

Size Code	Pipe Diameter	Marker Size	Letter Height	Price/Each
STA	3/4 to 1 1/4	6 x 8	1/2	7.36
STB	1 1/2 to 2	9 x 8	3/4	9.72
STC	2 1/4 to 3	14 x 12	1 1/4"	18.10
STE	3 1/4 to 5	19 x 12*	1 1/4"	20.00
STF	5 1/4 to 6	25 x 12*	1 1/4"	20.70

\*Sizes STE and STF have self-adhesive leading edge for a secure fit.

IF YOU DO NOT SEE THE LEGEND OR SIZE YOU ARE LOOKING FOR PLEASE CALL US!

OFFICE PRODUCTS

INSTRUMENTS, SCALES & ELECTRICAL

SHIPPING & PACKAGING

TOOLS & EQUIPMENT

WELDING & METALWORKING

SAFETY EQUIPMENT & SUPPLIES

JANITORIAL & MAINTENANCE

MATERIAL HANDLING & STORAGE

# LABELLING SYSTEMS & SUPPLIES



## FRENCH LABELS

Self Stick Vinyl Pipe Markers				Pipe Marker Legend	Snap Tite™ Pipe Markers				
Style SSA	Style SSB	Style SSD	Style SSH		Style STA	Style STB	Style STC	Style STE	Style STF
SAY976	SAY977	SQ576	SAH188	EAU À HAUTE PRESSION	SAZ271	SAZ272	SAZ273	SAZ274	SAZ275
SAY978	SAY979	SQ583	SQ582	EAU CHAUDE	SAZ276	SAZ277	SAZ278	SAZ279	SAZ280
SAY980	SAY981	SQ589	SAH195	EAU CHAUDE DOMESTIQUE	SAZ281	SAZ282	SAZ283	SAZ284	SAZ285
SAY982	SAY983	SQ597	SAH203	EAU D'APPOINT	SAZ286	SAZ287	SAZ288	SAZ289	SAZ290
SAY984	SAY985	SQ627	SAH219	EAU DE PLUIE	SAZ291	SAZ292	SAZ293	SAZ294	SAZ295
SAY986	SAY987	SQ639	SQ638	EAU DE TOUR D'EAU	SAZ296	SAZ297	SAZ298	SAZ299	SAZ300
SAY988	SAY989	SQ657	SQ656	EAU FROIDE	SAZ301	SAZ302	SAZ303	SAZ304	SAZ305
SAY990	SAY991	SQ661	SQ660	EAU FROIDE DOMESTIQUE	SAZ306	SAZ307	SAZ308	SAZ309	SAZ310
SAY992	SAY993	SQ668	SQ667	EAU MUNICIPALE	SAZ311	SAZ312	SAZ313	SAZ314	SAZ315
SAY994	SAY995	SBA712	SAH241	EAU NON POTABLE	SAZ316	SAZ317	SAZ318	SAZ319	SAZ320
SAY996	SAY997	SQ673	SAH243	EAU POTABLE	SAZ321	SAZ322	SAZ323	SAZ324	SAZ325
SAY998	SAY999	SQ676	SQ675	EAU POTABLE	SAZ326	SAZ327	SAZ328	SAZ329	SAZ330
SAZ001	SAZ002	SQ679	SQ678	EAU RECIRCULÉE	SAZ331	SAZ332	SAZ333	SAZ334	SAZ335
SAZ003	SAZ004	SQ681	SAH247	EAU RECIRCULÉE	SAZ336	SAZ337	SAZ338	SAZ339	SAZ340
SAZ005	SAZ006	SQ683	SR038	EAU RÉFRIGÉRÉE	SAZ341	SAZ342	SAZ343	SAZ344	SAZ345
SAZ007	SAZ008	SQ688	SQ687	EAU SYSTÈME D'INCENDIE	SAZ346	SAZ347	SAZ348	SAZ349	SAZ350
SAZ009	SAZ010	SQ723	SAH277	ÉVÈNT	SAZ351	SAZ352	SAZ353	SAZ354	SAZ355
SAZ011	SAZ012	SQ727	SQ726	ÉVÈNT	SAZ356	SAZ357	SAZ358	SAZ359	SAZ360
SAZ013	SAZ014	SQ730	SAH278	ÉVÈNT	SAZ361	SAZ362	SAZ363	SAZ364	SAZ365
SAZ015	SAZ016	SQ741	SQ740	FILTRE	SAZ366	SAZ367	SAZ368	SAZ369	SAZ370
SAZ017	SAZ018	SQ742	SAH290	FLUIDE FRIGORIGÈNE	SAZ371	SAZ372	SAZ373	SAZ374	SAZ375
SAZ019	SAZ020	SQ744	SAH292	FRÉON	SAZ376	SAZ377	SAZ378	SAZ379	SAZ380
SAZ021	SAZ022	SQ748	SQ747	GAZ	SAZ381	SAZ382	SAZ383	SAZ384	SAZ385
SAZ023	SAZ024	SQ762	SBA741	GAZ COMBUSTIBLE	SAZ386	SAZ387	SAZ388	SAZ389	SAZ390
SAZ025	SAZ026	SQ776	SQ775	GAZ NATUREL	SAZ391	SAZ392	SAZ393	SAZ394	SAZ395
SAZ027	SAZ028	SQ781	SAH308	GAZ PROPANE	SAZ396	SAZ397	SAZ398	SAZ399	SAZ400
SAZ029	SAZ030	SQ784	SAH309	GICLEUR	SAZ401	SAZ402	SAZ403	SAZ404	SAZ405
SAZ031	SAZ032	SQ787	SAH310	GICLEUR D'EAU	SAZ406	SAZ407	SAZ408	SAZ409	SAZ410
SAZ033	SAZ034	SQ792	SQ791	GICLEUR D'INCENDIE	SAZ411	SAZ412	SAZ413	SAZ414	SAZ415
SAZ035	SAZ036	SQ810	SAH320	HUILE	SAZ416	SAZ417	SAZ418	SAZ419	SAZ420
SAZ037	SAZ038	SQ825	SAH325	HYDROXYDE DE SODIUM	SAZ421	SAZ422	SAZ423	SAZ424	SAZ425
SAZ039	SAZ040	SQ864	SAH336	OXYGÈNE	SAZ426	SAZ427	SAZ428	SAZ429	SAZ430
SAZ041	SAZ042	SQ870	SAH337	OXYGÈNE	SAZ431	SAZ432	SAZ433	SAZ434	SAZ435
SAZ043	SAZ044	SQ915	SAH365	RETOUR	SAZ436	SAZ437	SAZ438	SAZ439	SAZ440
SAZ045	SAZ046	SQ918	SQ917	RETOUR	SAZ441	SAZ442	SAZ443	SAZ444	SAZ445
SAZ047	SAZ048	SQ922	SQ921	RETOUR	SAZ446	SAZ447	SAZ448	SAZ449	SAZ450
SAZ049	SAZ050	SQ928	SQ927	RETOUR D'EAU CHAUDE	SAZ451	SAZ452	SAZ453	SAZ454	SAZ455
SAZ051	SAZ052	SQ931	SQ930	RETOUR D'EAU DE CHAUFFAGE	SAZ456	SAZ457	SAZ458	SAZ459	SAZ460



### SELF-STICK

Size Code	Pipe Diameter"	Marker Size"	Letter Height"	Price/Each
SSA	3/4 to 1 1/4	1 x 8	1/2	3.12
SSB	1 1/2 to 2	1 1/2 x 8	3/4	3.29
SSD	2 1/2 to 6	2 1/2 x 12	1 1/4	4.01
SSH	8 to 10	4 x 24	2 1/2	10.10

### SNAP TITE™

Size Code	Pipe Diameter"	Marker Size"	Letter Height"	Price/Each
STA	3/4 to 1 1/4	6 x 8	1/2	7.36
STB	1 1/2 to 2	9 x 8	3/4	9.72
STC	2 1/4 to 3	14 x 12	1 1/4	18.10
STE	3 1/4 to 5	19 x 12*	1 1/4	20.00
STF	5 1/4 to 6	25 x 12*	1 1/4	20.70

\*Sizes PE and PF have self-adhesive leading edge for a secure fit.

IF YOU DO NOT SEE THE LEGEND OR SIZE YOU ARE LOOKING FOR PLEASE CALL US!



## FRENCH LABELS

Style SSA	Self Stick Vinyl Pipe Markers			Pipe Marker Legend	Snap Tite™ Pipe Markers				
	Style SSB	Style SSD	Style SSH		Style STA	Style STB	Style STC	Style STE	Style STF
SAZ053	SAZ054	SQ934	SQ933	RETOUR D'EAU DE CONDENSEUR	SAZ461	SAZ462	SAZ463	SAZ464	SAZ465
SAZ055	SAZ056	SQ939	SQ938	RETOUR D'EAU RÉFRIGÉRÉE	SAZ466	SAZ467	SAZ468	SAZ469	SAZ470
SAZ057	SAZ058	SQ951	SAH385	RETOUR DE CONDENSATS	SAZ471	SAZ472	SAZ473	SAZ474	SAZ475
SAZ059	SAZ060	SQ955	SAH389	RETOUR DE GLYCOL	SAZ476	SAZ477	SAZ478	SAZ479	SAZ480
SAZ061	SAZ062	SQ958	SQ957	RETOUR DE L'EAU DE TOUR D'EAU	SAZ481	SAZ482	SAZ483	SAZ484	SAZ485
SAZ063	SAZ064	SQ960	SAH392	RETOUR DE MAZOUT	SAZ486	SAZ487	SAZ488	SAZ489	SAZ490
SAZ065	SAZ066	SQ962	SAH394	RETOUR DE VAPEUR	SAZ491	SAZ492	SAZ493	SAZ494	SAZ495
SAZ067	SAZ068	SQ978	SAH407	SORTIE	SAZ496	SAZ497	SAZ498	SAZ499	SAZ500
SAZ069	SAZ070	SQ980	SAH409	SORTIE DE POMPE À CONDENSATS	SAZ501	SAZ502	SAZ503	SAZ504	SAZ505
SAZ071	SAZ072	SR002	SR001	TUYAU D'ÉCHAPPEMENT	SAZ506	SAZ507	SAZ508	SAZ509	SAZ510
SAZ073	SAZ074	SR004	SAH424	TUYAU D'ÉCHAPPEMENT	SAZ511	SAZ512	SAZ513	SAZ514	SAZ515
SAZ075	SAZ076	SR007	SR006	VAPEUR	SAZ516	SAZ517	SAZ518	SAZ519	SAZ520
SAZ077	SAZ078	SR011	SR010	VAPEUR À BASSE PRESSION	SAZ521	SAZ522	SAZ523	SAZ524	SAZ525
SAZ079	SAZ080	SR014	SR013	VAPEUR À HAUTE PRESSION	SAZ526	SAZ527	SAZ528	SAZ529	SAZ530
SAV581	SAV582	SAV583	SAV584		SAW309	SAW310	SAW311	SAW312	SAW313
SAV585	SAV586	SAV587	SAV588		SAW314	SAW315	SAW316	SAW317	SAW318
SAV589	SAV590	SAV591	SAV592		SAW319	SAW320	SAW321	SAW322	SAW323
SAV593	SAV594	SAV595	SAV596		SAW324	SAW325	SAW326	SAW327	SAW328
SAV597	SAV598	SAV599	SAV600		SAW329	SAW330	SAW331	SAW332	SAW333
SAV601	SAV602	SAV603	SAV604		SAW334	SAW335	SAW336	SAW337	SAW338
SAV605	SAV606	SAV607	SAV608		SAW339	SAW340	SAW341	SAW342	SAW343
SAV609	SAV610	SAV611	SAV612		SAW344	SAW345	SAW346	SAW347	SAW348



## SELF-STICK

Size Code	Pipe Diameter"	Marker Size"	Letter Height"	Price/Each
SSA	3/4 to 1 1/4	1 x 8	1/2	3.12
SSB	1 1/2 to 2	1 1/2 x 8	3/4	3.29
SSD	2 1/2 to 6	2 1/2 x 12	1 1/4	4.01
SSH	8 to 10	4 x 24	2 1/2	10.10

## SNAP TITE™

Size Code	Pipe Diameter"	Marker Size"	Letter Height"	Price/Each
STA	3/4 to 1 1/4	6 x 8	1/2	7.36
STB	1 1/2 to 2	9 x 8	3/4	9.72
STC	2 1/4 to 3	14 x 12	1 1/4	18.10
STE	3 1/4 to 5	19 x 12*	1 1/4	20.00
STF	5 1/4 to 6	25 x 12*	1 1/4	20.70

\*Sizes STE and STF have self-adhesive leading edge for a secure fit.

Need a Leak Diverter?  
Look at our selection  
on page 683



IF YOU DO NOT SEE THE LEGEND OR SIZE YOU ARE LOOKING FOR PLEASE CALL US!



## THE GLOBALLY HARMONIZED SYSTEM (GHS)

The Globally Harmonized System of Classification and Labeling of Chemicals (GHS) is an international system established by the United Nations to replace pre-existing classification and labeling methods. GHS presents a unified code to eliminate discrepancies in labeling conventions from one country to another. Using a harmonized standard reduces the chance of misinterpretation or confusion, thereby increasing safety regardless of the language spoken or even the level of literacy of those working with the substances.

It covers the following:

- Classification of physical health and environmental hazards
- Labeling environments
- Universal symbols and pictograms
- Hazard warning statements, aspiration hazards
- Signal word for type of hazard
- Safety data sheet format

The risk of chemical exposure lurks at any stage; be it production, transport, handling or use. Incomplete or ambiguous data can be not only dangerous but have a negative impact on productivity. As such, GHS is designed to protect the environment as well as workers, consumers, transport workers, and emergency responders.

One of the other aims of GHS is to improve and expand international knowledge of the chronic health hazards of chemicals and thereby reduce, eliminate and/or replace these chemicals. Due to the complex nature of this domain, the GHS is constantly being modified and revised. Effective date is proposed to be two years after publication of final rule passage by Congress.



## WHMIS REQUIREMENTS

The Workplace Hazardous Material Information System (WHMIS) is enforced nationwide. It was developed as a way of protecting workers from the adverse effects of hazardous materials in the workplace. WHMIS gives both the employers and employees the right to know about hazards associated with chemicals they work with. This is accomplished through the use of Material Safety Data Sheets (MSDS), proper labelling and training.

### Material Safety Data Sheets must:

1. Accompany every shipment of hazardous material.
2. Be kept on file and be accessible to all employees.
3. Be updated and revised every 3 years.

### Must contain the following information (as a minimum):

- Hazardous ingredients
- Preparation information
- Product information
- Physical data
- Fire or explosion data
- Reactivity data
- Toxicological properties
- Preventative measure
- First aid measures

### Supplier label must:

1. Be supplied by the manufacturer of the chemical.
2. Be applied to every container of hazardous material.
3. Have the distinct Hash border.

### Must contain a total of 7 pieces of information:

- Product identifier
- Supplier identifier
- Hazard symbol
- Risk phrase
- Precautionary measures
- First Aid measures
- Reference to MSDS

### Workplace labels are required:

1. When the supplier label has been damaged or fallen off.
2. When transferring chemical from the original container to a smaller one.
3. To contain at least 3 pieces of information:
  - Product identifier
  - Precautionary measure
  - Reference to MSDS

### Training is an important part of WHMIS.

#### Training must cover such things as:

- How to read and understand labels and MSDS
- Procedures for safe use, storage, handling and disposal of hazardous material
- Procedures to be followed in case of emergency

Every employee who comes in contact with hazardous material must be trained

## WHMIS AFTER GHS

The original WHMIS is not being replaced but rather updated to align as closely as possible with the United States and other key trading partners. The new WHMIS will be called "WHMIS 2015".

### TRANSITION PERIOD

	Manufacturers & Importers	Distributors	Employers
<b>Phase 1</b> From coming into force to June 1, 2017	Use CPR or HPR requirements	Use CPR or HPR requirements	Use CPR or HPR requirements
<b>Phase 2</b> From June 1, 2017, to June 1, 2018	Use HPR requirements	Use CPR or HPR requirements	Use CPR or HPR requirements
<b>Phase 3</b> From June 1, 2018, to December 1, 2018	Use HPR requirements	Use HPR requirements	Use CPR or HPR requirements
<b>Completion</b> December 1, 2018	Use HPR requirements	Use HPR requirements	Use HPR requirements



## CUSTOM GHS LABELS

CREATE YOUR OWN LABELS TO CONVEY HAZARD CLASS INFORMATION.

### How to Order:

1. Specify label size and material by part number
2. Send us your chemical or material information Refer to "Required Label Elements" guide
3. Provide guidance on label design if different from examples
4. Contact us with your request; we'll send you a proof (upon request)

### MATERIAL CHOICES

**Adhesive-poly sheet** - Flexible 2.6-mil thick vinyl has self-adhesive back. Peel-off liner and pressure-sensitive back permanently adheres to smooth, curved and irregular surfaces. Moisture resistant with outdoor durability

**Adhesive coated paper** - Economical, self-adhesive label is durable for limited use. 60-lb. coated paper with acrylic adhesive back. Peel off liner and permanently adhere to smooth, curved and irregular surfaces.

Sizes available in 3" x 4", 4" x 6", 6" x 8", 9" x 12", 10" x 14".

\*9" x 12" and 10" x 14" (or larger) labels are recommended when DOT label pictogram is included to maintain the required 4" x 4" (100 mm x 100 mm) size.

**ACETONE**

**DANGER**  
Highly flammable liquid and vapor.  
Causes severe eye irritation.

Keep away from heat, sparks, open flames and hot surfaces. Keep container closed when not in use. Use only in a well-ventilated area. Wear appropriate personal protective equipment. Flush eyes with water for at least 15 minutes while holding eyelids open.

Company Name: \_\_\_\_\_  
Address: \_\_\_\_\_  
City: \_\_\_\_\_ State: \_\_\_\_\_

CAS Number: 67-64-1  
Category 2 Flammable Liquid and  
Category 2A Eye Damage/Irritation

Format 1

---

**CAS Number: 67-64-1  
ACETONE**

**Danger**  
Highly flammable liquid and vapor.  
Causes severe eye irritation.

Company Confidential

1234 First Avenue  
Any Town, Any State 12345  
Phone Number: 123-456-7891

Fill weight: 10 lbs.  
Gross weight: 21 lbs.  
Expiration: 5/13/14  
Lot Number: 012456  
Fill Date: 8/14/12

Keep away from heat, sparks and flame - No smoking. Take precautionary measures against static discharge. Keep from direct sunlight. Keep container closed when not in use. Store in a cool/low temperature, well-ventilation place away from heat and ignition sources. Use only in a well ventilated area. Avoid contact with eyes, skin and clothing. Wear appropriate personal protective equipment, avoid direct contact. Flush eye with water for at least 15 minutes while holding eyelids open.

Format 2

Actual label design and layout may vary and are subject to the discretion of the competent authority.

### REQUIRED LABEL ELEMENTS

1. **Product Identifier** - Should match the product identifier used on the Safety Data Sheets.
2. **Signal Word** - Indicates the relative level of the hazard's severity. "Danger" and "Warning" are the GHS signal words.
3. **Pictograms** - Graphic compositions intended to convey specific hazard information.
4. **Hazard Statements** - A phrase assigned to a hazard class and category that describes the nature of the product hazards.
5. **Precautionary Statements** - Describe recommended measures to minimize or prevent adverse effects resulting from exposure.
6. **Supplier Identification** - The name, address and telephone number of the manufacturer or supplier.

**Note:** You are required to provide all necessary information specific to your hazardous chemical or material, to complete an accurate and safe label for your premises.



## CUSTOM WHMIS-GHS SUPPLIER LABELS

Manufacturers and suppliers of hazardous materials or chemicals are required to label drums, pails, bottles, and any other container of the product - as specified by the Hazardous Products Act and Regulations (WHMIS 2015).

Labels are specific in appearance and must follow particular format and information guidelines as specified by WHMIS. These labels must contain detailed hazard information in both English and French.

To order, specify material below and provide us a size. We will get back to you with a quote, proof, and delivery time.

### Label Material

- Pressure Sensitive Paper
- Adhesive Vinyl
- Durable Laminated Adhesive Vinyl

**Call us today for a quote!**

When ordering labels, please provide us the following information from the Safety Data Sheet (SDS) for required label elements:

English

French

**Product K1 / Produit K1**

**Danger**  
Fatal if swallowed.  
Causes skin irritation.

**Precautions:**  
Wear protective gloves.  
Wash hands thoroughly after handling.  
Do not eat, drink or smoke while using this product.

Store locked up.  
Dispose of contents according to instructions on this label/regulatory.

If on skin: Wash with plenty of water.  
If on clothing: Remove and launder before reuse.  
If swallowed: Immediately call a POISON CENTER or doctor.  
See inside.

**Danger**  
Mortel en cas d'inhalation.  
Provoque une irritation cutanée.

**Conseils:**  
Porter des gants de protection.  
Eviter de manger, boire ou fumer en manipulant ce produit.

Stocker sous clé.  
Éliminer le contenu conformément aux indications figurant sur l'étiquette.

En cas de contact avec la peau: Laver abondamment à l'eau.  
En cas de contact avec les vêtements: Retirer et laver abondamment en machine.  
Éliminer les vêtements contaminés et les laver abondamment.  
En cas d'inhalation: Reporter immédiatement au médecin. Rincer la bouche.

Compagnie XYZ, 123 rue Main St, Mississ, ON, N6H 8H6 (123-456-7890)

### Supplier label must include the following:

**Product identifier** - the brand name, chemical name, common name, generic name or trade name of the hazardous product.

**Initial supplier identifier** - the name, address and telephone number of either the Canadian manufacturer or the Canadian importer\*.

**Pictogram(s)** - hazard symbol within a red "square set on one of its points".

**Signal word** - a word used to alert the reader to a potential hazard and to indicate the severity of the hazard.

**Hazard statement(s)** - standardized phrases which describe the nature of the hazard posed by a hazardous product.

**Precautionary statement(s)** - standardized phrases that describe measures to be taken to minimize or prevent adverse effects resulting from exposure to a hazardous product or resulting from improper handling or storage of a hazardous product.

**Supplemental label information** - some supplemental label information is required based on the classification of the product. For example, the label for a mixture containing ingredients with unknown toxicity in amounts higher than or equal to 1% must include a statement indicating the percent of the ingredient or ingredients with unknown toxicity. Labels may also include supplementary information about precautionary actions, hazards not yet included in the GHS, physical state, or route of exposure. This information must not contradict or detract from the standardized information.



# GHS/WHMIS REQUIREMENTS & LABELS

## GHS PICTOGRAM LABELS

- GHS pictograms identify the hazards associated with chemicals and warn users of the precautions that should be taken
- The GHS recognizes ten hazard pictograms
- Labels are available in adhesive-poly sheet or adhesive coated paper
- Available in rolls of 250 or 500
- Adhesive-poly sheet (EV):** Flexible 2.6-mil thick vinyl has self-adhesive back. Peel-off liner and pressure-sensitive back permanently adheres to smooth, curved and irregular surfaces. Moisture resistant with outdoor durability
- Adhesive coated paper (PS):** Economical, self-adhesive label is durable for limited use. 60-lb. coated paper with acrylic adhesive back. Peel off liner and permanently adhere to smooth, curved and irregular surfaces



### ADHESIVE-POLY (EV)

Size"	Qty/Roll	Flame	Flame Over Circle	Exploding Bomb	Corrosion	Gas Cylinder	Skull Crossbones	Exclamation Mark	Environmental	Health Hazard	Biohazardous Infectious Materials	Price /Each
1 x 1	250/Roll	SEF642	SEF646	SEF650	SEF654	SEF658	SEF662	SEF666	SEF670	SEF674	SDN378	38.00
1 x 1	500/Roll	SEF643	SEF647	SEF651	SEF655	SEF659	SEF663	SEF667	SEF671	SEF675	SDN379	60.70
2 x 2	250/Roll	SEF678	SEF682	SEF686	SEF690	SEF694	SEF698	SEF702	SEF706	SEF710	SDN380	44.90
2 x 2	500/Roll	SEF679	SEF683	SEF687	SEF691	SEF695	SEF699	SEF703	SEF707	SEF711	SDN381	72.10
4 x 4	250/Roll	SDN390	SDN394	SDN398	SDN402	SDN406	SDN410	SDN414	SDN418	SDN422	SDN382	61.50
4 x 4	500/Roll	SDN391	SDN395	SDN399	SDN403	SDN407	SDN411	SDN415	SDN419	SDN423	SDN383	98.50

### ADHESIVE COATED PAPER (PS)

Size"	Qty/Roll	Flame	Flame Over Circle	Exploding Bomb	Corrosion	Gas Cylinder	Skull Crossbones	Exclamation Mark	Environmental	Health Hazard	Biohazardous Infectious Materials	Price /Each
1 x 1	250/Roll	SEF644	SEF648	SEF652	SEF656	SEF660	SEF664	SEF668	SEF672	SEF676	SDN384	24.50
1 x 1	500/Roll	SEF645	SEF649	SEF653	SEF657	SEF661	SEF665	SEF669	SEF673	SEF677	SDN385	39.20
2 x 2	250/Roll	SEF680	SEF684	SEF688	SEF692	SEF696	SEF700	SEF704	SEF708	SEF712	SDN386	28.90
2 x 2	500/Roll	SEF681	SEF685	SEF689	SEF693	SEF697	SEF701	SEF705	SEF709	SEF713	SDN387	46.50
4 x 4	250/Roll	SDN392	SDN396	SDN400	SDN404	SDN408	SDN412	SDN416	SDN420	SDN424	SDN388	39.70
4 x 4	500/Roll	SDN393	SDN397	SDN401	SDN405	SDN409	SDN413	SDN417	SDN421	SDN425	SDN389	63.40

## GHS HAZARD PICTOGRAM LABEL VARIETY PACKS

- Assortment of all the GHS hazard class pictograms labels in one convenient pack
- Labels are manufactured on high gloss paper stock with removable adhesive
- Easy to peel cleanly from most surfaces including glass, metal and plastic
- A great choice for use in laboratory settings
- Available in two sizes



## GHS/WHMIS 2015 WALLET CARDS

- Keep a visual reminder of GHS label and pictogram requirements close at hand for easy reference
- Plastic wallet card measures 3 3/8" x 2 1/8" and is double sided
- One side of the wallet card shows a representation of the 10 standard GHS pictograms, while the flip side shows a GHS label example
- Available in English or French



Model No.	Mfg No.	Label Size"	Quantity	Price/Each
SEJ584	GHS1300	1/2	1820 Labels/Pad	95.90
SEJ585	GHS1299	1	1120 Labels/Pad	104.00

Model No.	Mfg No.	Description	Price/Each
SDN426	LKC243	English	4.18
SDN427	FRLKC243	French	4.18



# GHS/WHMIS REQUIREMENTS & LABELS



## GHS, WHMIS & PPE PICTOGRAM LABELS

- Pictograms communicate universally understood GHS, WHMIS Hazard symbols and approval PPE wear requirements
- Adhere to containers to convey the controlled product message
- Labels are high-performance, adhesive dura-vinyl (overlamine graphics)
- Resistant to abrasive, humidity, chemicals, solvents, and sunlight fade
- Available in two sizes

### GHS



Flame  
SDN428  
SDN429



Flame Over Circle  
SDN430  
SDN431



Exploding Bomb  
SDN432  
SDN433



Corrosion  
SDN434  
SDN435



Gas Cylinder  
SDN436  
SDN437



Skull Crossbones  
SDN438  
SDN439



Exclamation Mark  
SDN440  
SDN441



Environment  
SDN442  
SDN443



Severe Health Hazard  
SDN444  
SDN445



Biohazardous Infectious  
Materials  
SDN446  
SDN447

### WHMIS



Class A  
Compressed Gas  
SAX239  
SAX240

Label Size  
2" (~ 50 mm)  
4" (~ 100 mm)



Class B  
Flammable/ Combustible  
SAX253  
SAX254



Class C  
Oxidizing  
SAX241  
SAX242



Class D - Division 1  
Immediately/Seriously Toxic  
SAX245  
SAX246



Class D - Division 2  
Other Toxic  
SAX249  
SAX250

Label Size  
2" (~ 50 mm)  
4" (~ 100 mm)



Class D - Division 3  
Biohazardous Infectious  
SAX243  
SAX244



Class E  
Corrosive  
SAX251  
SAX252



Class F  
Dangerously Reactive  
SAX247  
SAX248

### PPE



Safety Goggles  
SAX255  
SAX256

Label Size  
2" (~ 50 mm)  
4" (~ 100 mm)



Face Shield  
SAX257  
SAX258



Apron  
SAX259  
SAX260



Dust Mask  
SAX261  
SAX262



Vapour Respirator  
SAX263  
SAX264



Self-Contained Air Respirator  
SAX265  
SAX266



Gloves  
SAX267  
SAX268

Label Size  
2" (~ 50 mm)  
4" (~ 100 mm)



Boots  
SAX269  
SAX270



Full Protection Suit  
SAX271  
SAX272



Label Size	Qty/Pkg.	Price/Pkg.
2" (~50 mm)	10	45.00
4" (~100 mm)	5	40.90

# GHS/WHMIS REQUIREMENTS & LABELS

## RIGHT-TO-KNOW LABELING KITS

- Quickly and easily customise adhesive vinyl labels with Right-To-Know information
- Write in chemical name and hazard ratings
- Use WHMIS pictogram stickers to identify hazards and personal protection
- Available in two formats: NFPA Diamond or Colour Bar
- Use clear overlaminates for added protection
- Kit includes 1 sheet of 17 pictogram stickers and choice of NFPA Diamond or Colour Bar format

### Pictogram Stickers

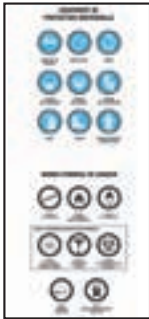

### Colour Bar

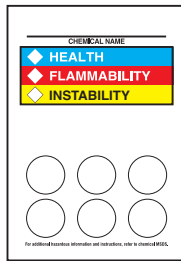

### NFPA Diamond

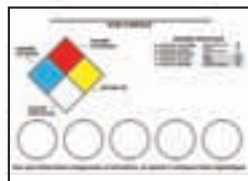

Model No.	Mfg No.	Size"	Style	Description	Price/Each
SAX167	LZN440	3 1/2 x 5	NFPA Diamond	English	9.55
SAX168	LZN442	5 x 7	NFPA Diamond	English	19.80
SAX169	LZS640	5 x 3 1/2	Colour Bar	English	9.55
SAX170	LZS642	7 x 5	Colour Bar	English	19.80
SEL118	FRLZN440	3 1/2 x 5	NFPA Diamond	French	9.55

## SELF-LAMINATING ROLL LABELS

- Fill in hazard codes and symbols in area provided
- Clear polyester flap adheres and covers label to protect information
- Vinyl label has self-adhesive back



Model No.	Mfg No.	Size"	Description	Price/Roll of 100
SAX298	LZS321EV	1 x 3	English	62.50
SEL121	FRLZS321EV	1 x 3	French	62.50

## WHMIS WALLET CARDS

Indicated date of WHMIS certification verifying employee's WHMIS training. Reverse side features a handy reminder of WHMIS symbols. Package: 25 cards.



Priced per Package

Model No.	Mfg. No.	Description	Price/Each
SJ010	09403	English	13.98
SJ012	09396	Bilingual	13.98

## WHMIS WORKPLACE LABELS

- Easy-to-use, adhesive vinyl, write-on label
- Write in product name, precautionary measures and first aid information
- Check off appropriate hazard and protective equipment symbols
- Available in 3 sizes
- Use clear overlaminates for added protection

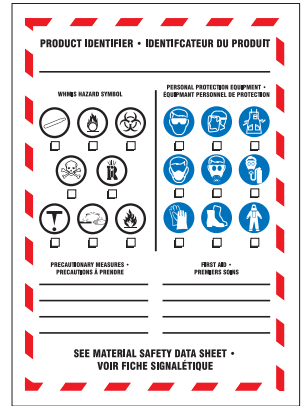

Model No.	Mfg No.	Description	Size	Price/Each
SAX174	LZW305	Bilingual	127 mm x 89 mm (5" x 3 1/2")	4.12
SAX175	LZW307	Bilingual	178 mm x 127 mm (7" x 5")	9.55
SAX176	LZW310	Bilingual	254 mm x 178 mm (10" x 7")	13.20

## CLEAR OVERLAMINATE

Model No.	Mfg No.	Description	Size	Price/Each
SAX177	LZS155	Bilingual	127 mm x 89 mm (5" x 3 1/2")	2.10
SAX178	LZS156	Bilingual	178 mm x 127 mm (7" x 5")	4.79
SAX179	LZS177	Bilingual	254 mm x 178 mm (10" x 7")	6.58

## OTS WHMIS LABELS

- On-The-Spot WHMIS labels
- Convenient, easy-to-use
- Create workplace labels in minutes
- Made of vinyl material
- Self-laminating labels for extra protection against chemical contact
- Simply enter the product identifier using a pen or a permanent marker, pick the appropriate WHMIS and PPE symbols, add any specific handling precautions, apply laminate and adhere label to the container
- Sold in packages of 25



Priced per Package

Model No.	Mfg. No.	Size"	Description	Price/Each
SY084	08657	5 x 5	Self Laminating	68.10
SY083	08660	3 x 6	Self Laminating	67.70
SY074	08662	2 x 4	Self Laminating	50.54

## SHARPIE MARKERS

- Black fine Point Marker
- Extra tough tip that won't spread or mush
- High visibility ink

Model No. PA393  
Mfg. No. SAN30001  
Price/Each \$1.50



# GHS/WHMIS REQUIREMENTS & LABELS

## WHMIS INFORMATION CHARTS

This wall chart provides detailed information on proper WHMIS labeling, descriptions of class symbols, personal protective equipment symbols, MSDS, and it also outlines the responsibilities of suppliers, employers and employees.

- Made of 1/8" thick rigid plastic board
- Centre is bilingual (English and French)
- Available in two sizes

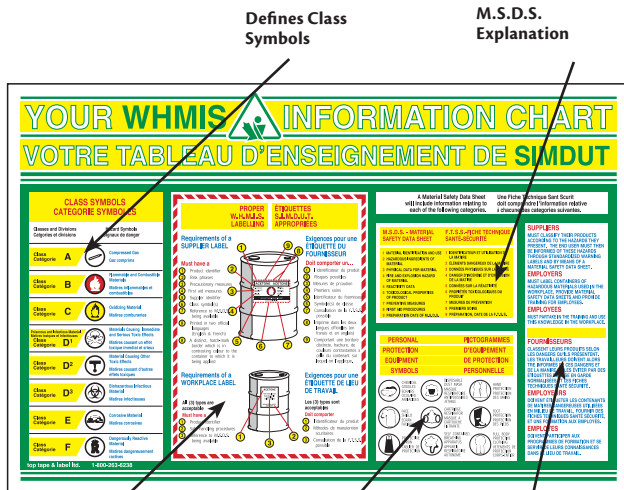

Defines Class Symbols

M.S.D.S. Explanation

Proper way to label W.H.M.I.S. for compliance

Personal Protective Equipment Symbols and meanings

Supplier, Employer & Employee responsibilities outlined

**INCOM**

Model No.	Mfg. No.	Size"	Price /Each
SB611	W9095	12 x 18	83.90
SB612	W9094	24 x 36	119.00

## RIGHT-TO-KNOW: SDS POSTERS

- Display poster shows employees what information must be included in the new regulation Safety Data sheets (SDS) to comply with OSHA and GHS requirements
- Summary of the GHS standardized 16-section SDS
- Instructional sections cover product and company identification, hazards identification, composition, first aid measures and more
- Size: 20" x 32"
- Flexible plastic poster
- Available in English and French

SEJ572



**ACCUFORM**

Model No.	Mfg No.	Description	Price/Each
SEJ572	ZTP133	English	62.40
SEJ573	FRZTP133	French	62.40

## GHS POSTERS

- Displays GHS label and pictogram guidelines
- Guidelines separated into easy-to-understand sections
- Plastic laminate poster
- Size: 18" x 24"
- Available in English or French

SEJ570



**ACCUFORM**

Model No.	Mfg No.	Description	Price/Each
SEJ570	ZTP139	English	46.10
SEJ571	FRZTP139	French	46.10

## HAZ-MAT WARNING LABEL POSTERS

- Reference posters quickly decipher hazardous material warning label systems
- Choose from combination of NFPA and HMCIS (SAX192) or NFPA, HMCIS and WHMIS (SAX193)
- 457 mm x 610 mm (18" x 24") durable plastic laminated posters

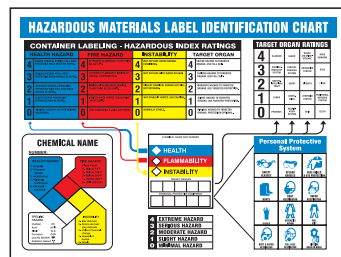

SAX192

SAX193

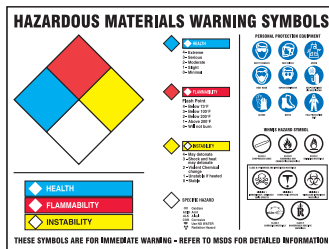

**ACCUFORM**

Model No.	Mfg No.	Description	Price/Each
SAX192	ZTP108	NFPA and HMCIS, English	46.10
SAX193	ZTP127	NFPA, HMCIS and WHMIS, English	46.10
SEL119	FRZTP108	NFPA and HMCIS, French	46.10
SEL120	FRZTP127	NFPA, HMCIS and WHMIS, French	46.10

## GHS INFORMATION WALL CHARTS

- The GHS wall chart provides a comprehensive overview of new GHS labeling requirements for WHMIS
- The chart details the 3 main hazard groups; Physical, Health & Environmental
- Lists requirements for supplier labels when decanting or transferring hazardous chemicals
- Visual representations of the precautionary statement pictograms
- Lists the information required on the new regulation Safety Data Sheet
- Made of durable, pliable plastic
- Mount chart in a prominent place to help refresh your employee's knowledge of the GHS requirements
- Indoor or outdoor applications
- Available in two sizes and in English or English/French

SEJ599



**INCOM**

Model No.	Mfg No	Size"	Description	Price/Each
SEJ597	GHS1004C	18 x 24	English	97.70
SEJ598	GHS1003C	24 x 36	English	135.00
SEJ599	GHS1018	24 x 36	English/French	135.00



# GHS/WHMIS REQUIREMENTS & LABELS

## RIGHT-TO-KNOW BASKET STYLE CENTRE BOARDS

- Sturdy 0.063" thick aluminum backboard measures
  - Single basket style: 508 mm x 381 mm (20" H x 15" W)
  - Double basket style: 610 mm x 462 mm (24" H x 30" W)
- Coated wire basket bolted to lower portion to hold binder
- Single style centers include one 1 1/2" binder and double style centers include two 1 1/2" binders
- Boards have holes for wall mounting
- Comes in either single or double sized centers
- Available in MSDS or new regulation SDS



SAX183



SEJ557



Model No.	Mfg No.	Description	Price/Each
<b>MSDS</b>			
SAX182	ZRS305	MSDS Single Basket English	135.00
SAX183	ZRS307	MSDS Double Basket English	284.00
<b>SDS</b>			
SEJ556	ZRS339	SDS Single Basket English	135.00
SEJ557	FBZRS339	SDS Single Basket English/French	135.00
SEJ558	ZRS340	SDS Double Basket English	284.00
SEJ559	FBZRS340	SDS Double Basket English/French	284.00

## HAZ-MAT, WHMIS BASKET STYLE CENTRE BOARDS

- Constructed of sturdy 0.063" thick aluminum for durability
- Backboard is 508 mm x 381 mm (20" H x 15" W)
- Coated wire basket bolted to lower portion holds binder
- Includes 1 1/2" sized binder
- Boards have holes for wall mounting
- Available with MSDS binder or new regulation SDS binder



SAX184



SEJ555



Model No.	Mfg No.	Description	Price/Each
SAX184	ZRS321	Centre with MSDS Binder, English	135.00
SEJ555	ZRS349	Centre with SDS Binder, English	135.00
SEL122	FRZRS349	Centre with SDS Binder, French	135.00

## GHS INFORMATION STATIONS

- Provides a central location to easily access all newly regulated SDS sheets as well as the basic information required for the GHS system for WHMIS
- The board is printed with the 3 main hazard groups; Physical, Health & Environmental
- Provides requirements for supplier labels when decanting or transferring hazardous chemicals
- Visual representations of the precautionary statement pictograms
- Lists the information required on a Safety Data Sheet
- Printed in full colour on a mounting board and comes with a sturdy metal pocket
- Stations include either one (Single) or two (Double) standard 3-ring SDS binders with A - Z alphabetical dividers to sort all of your Safety Data Sheets
- The mounting board is constructed of 1/4" rigid plastic with 4 mounting holes to provide easy mounting and years of durability
- Available in two sizes in English or English/French



SEJ587



SEJ586



Model No.	Mfg No.	Size"	Description	Price/Each
SEJ586	GHS1002C	Single Station, 18 x 24	English	277.00
SEJ587	GHS1001C	Double Station, 24 x 36	English	435.00
SEJ588	GHS1072	Single Station, 18 x 24	English/French	254.00
SEJ589	GHS1019	Double Station, 24 x 36	English/French	435.00

Ask us about volume prices!



In many cases you will benefit from quantity prices.



# GHS/WHMIS REQUIREMENTS & LABELS

## SDS PROJECTION™ SIGNS

- 0.10" thick high-impact plastic
- 3D signs, projecting 45° from the wall, provide optimum viewing from front and sides
- 90D signs, projecting 90° from the wall, are viewed from either side
- Includes: mounting holes and hardware



SEJ568



SEJ569



Model No.	Mfg. No.	Panel Size"	Overall Size"	Standard 3D Price/Each	Standard 90D Price/Each
SEJ568	PSP768	6 x 5	6 x 8 1/2 x 4	32.10	—
SEJ569	PSP452	8 x 8	8 x 8 x 1 1/2	—	29.00

## STORAGE BOXES

- Durable 20-gauge steel box secures MSDS or SDS documents
- Sloping hinge lid has lockable hasp and foam gasket lining for outdoor exposure
- 2 1/2" binder included
- Measures 13 1/2" x 13 1/2" x 4 1/2" to hold up to a 3" wide binder
- Available in MSDS or new regulation SDS



SAX191



Model No.	Mfg No.	Description	Price/Each
SAX191	ZRS364	MSDS Storage Box w/Binder, English	328.00
SEJ562	ZRS367	SDS Storage Box w/Binder, English	328.00
SEL123	FRZRS367	SDS Storage Box w/Binder, French	328.00

## MSDS & SDS BINDERS

- Organize documents in bright, safety yellow binders
- Contrasting red letters on front cover and spine
- 3-ring binders have 914 mm (36") metal security chain
- Available in MSDS or new regulation SDS version

Model No.	Mfg No.	Description	Ring Size"	Price/Each
<b>MSDS</b>				
SAX186	ZRS631	MSDS English	1 1/2	38.10
SAX187	ZRS633	MSDS English	2 1/2	49.50
SAX188	ZRS639	MSDS English	3	53.00
SAX189	ZRS644	MSDS Bilingual	1 1/2	38.10
SAX190	ZRS646	MSDS Bilingual	2 1/2	49.50
<b>SDS</b>				
SEJ563	ZRS641	SDS English	1 1/2	38.10
SEJ564	ZRS642	SDS English	2 1/2	49.50
SEJ565	ZRS643	SDS English	3	53.00
SEJ566	FBZRS641	SDS Bilingual	1 1/2	38.10
SEJ567	FBZRS642	SDS Bilingual	2 1/2	49.50



SEJ563



SAX186

## SAFETY DATA SHEET INFORMATION STATIONS

- Provides a central place to easily access all the new regulation SDS sheets for your plant or office
- Sturdy metal pocket design to hold the included binder
- The mounting board is constructed of 1/4" rigid plastic with four mounting holes to provide easy mounting and years of durability
- Stations include either one (Single) or two (Double) standard 3-ring SDS binders with A - Z alphabetical dividers to sort all of your Safety Data Sheets
- Available in two sizes in English or English/French



SEJ590



SEJ593



Model No.	Mfg. No.	Size"	Description	Price/Each
SEJ590	GHS1012	Single Station, 18 x 24	English	239.00
SEJ591	GHS1011	Double Station, 24 x 36	English	405.00
SEJ592	GHS1021	Single Station, 18 x 24	English/French	239.00
SEJ593	GHS1020	Double Station, 24 x 36	English/French	405.00

## SAFETY DATA SHEET BINDERS

- Organize and access Safety Data Sheets quickly and easily with SDS binders
- Binders come in two sizes; 1 1/2" and 3"
- The regular size binders come with a standard 1 1/2" D-slant format ring
- The large binder comes with a 3" D-slant ring for easy storage of large numbers of SDS sheets
- All our binders come with sturdy A-Z alphabetical reinforced dividers to sort and organize your Safety Data Sheets
- Printed with bright graphics on a white background, these binders will be highly visible in the workplace



SEJ594



SDP091



Model No.	Mfg No.	Size"	Description	Price/Each
SEJ594	GHS1008	1 1/2	English	37.50
SEJ595	GHS1049	3	English	57.20
SEJ596	GHS1009	1 1/2	English/French	37.50
SDP091	GHS1082	3	English/French	57.20

# VEHICLE IDENTIFICATION

## 3M™ SCOTCHLITE™ DIAMOND GRADE™ CONSPICUITY SHEETING SERIES 983

- Series 983 sheeting features superior reflective qualities. It is also DOT-C2 certified and guaranteed to meet or exceed all NHTSA requirements. Series 983 sheeting offers the following:
- **Brightness**—six times brighter than conventional sheeting. Maintains its superior conspicuity with a bright white appearance during the day and high reflectivity at night
  - **Angularity**—reflects well at angles up to nearly 90°
  - **Outlining Capabilities**—helps identify vehicle size and type
  - **Durability**—resists weather, dirt and aging
  - **Seven-year warranty**—strong performance backed by more than 50 years of experience in reflective technology



Available in pre-cut strips and 50-yard rolls in solid white or alternating pattern. Alternating patterns conspicuity material with 7" white and 11" red, designed for balanced retroreflectivity between the two colours, or conspicuity material designed for more versatile applications with the 6" red and 6" white colour in 12" increments. Pre-cut strips are cut at the colour change for faster application. 100 strips per case.



Priced per Package

Model No.	Mfg. No.	Size	Qty /Pkg.	Price /Each
<b>SOLID WHITE</b>				
SN566	983-10-2X50	2" x 50 yards	1	151.00
SN567	983-10-3X50	3" x 50 yards	1	226.50
SN568	983-10-4X50	4" x 50 yards	1	302.00
SN569	983-10-2X12(100)	2" x 12" Strips	100	100.36
<b>ALTERNATING 7" WHITE THEN 11" RED</b>				
SN570	983-32-2X50	2" x 50 yards	1	151.00
SN571	983-32-3X50	3" x 50 yards	1	226.50
SN572	983-32-4X50	4" x 50 yards	1	302.00
SN573	983-32-2X18(100)	2" x 18" Strips	100	150.55
<b>ALTERNATING 6" WHITE THEN 6" RED</b>				
SN574	983-326-2X50	2" x 50 yards	1	151.00
SN575	983-326-3X50	3" x 50 yards	1	262.84
SN576	983-326-4X50	4" x 50 yards	1	350.44
SR390	983-326-2X12(100)	2" x 12" Strips	100	100.36
SR391	983-326-2X24(100)	2" x 24" Strips	100	200.72

\* Inquire about other colours and sizes



## NATIONAL HIGHWAY TRAFFIC SAFETY ADMINISTRATION (NHTSA) RECOMMENDATIONS (DOT-C2)

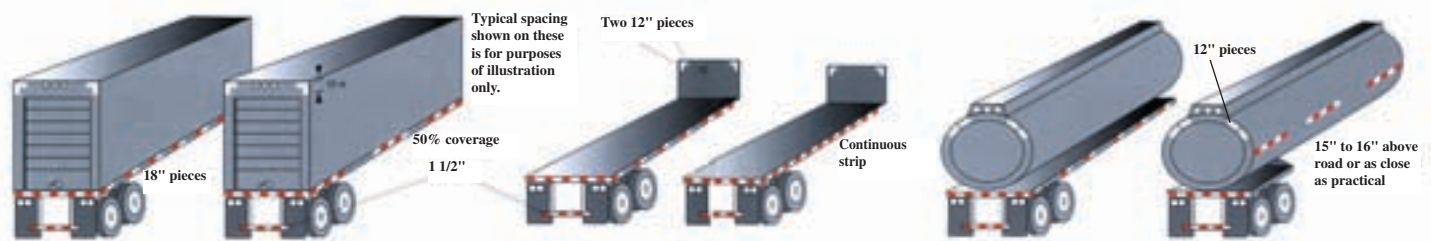

# The ultimate!

210-Piece Socket Set, made of chrome vanadium steel for extra strength and durability.

**aurora tools®**



Model TLV362  
See page 1313

## PLACARD HOLDERS

- Manufactured of natural aluminum with stainless steel clips for years of service
- Holders come with 10 pre-drilled mounting holes for easy application
- The back plate has several dimples to ease the placards out of the holder and up and over the clip assembly



SAQ008

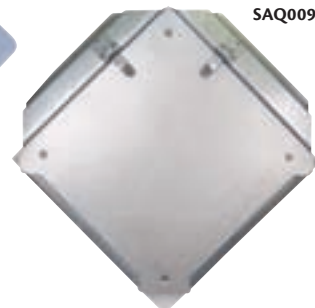

SAQ009

## INCOM

Model No.	Mfg. No.	Description	Price /Each
SAQ008	PH223	Placard holder	14.10
SAQ009	PH227	Easy Access Design	32.30

## SIGNS



18" x 18"

Model No.	Mfg. No.
SEI459 - PS	LVHR904XVE
SEI460 - AL	MVTR620VA



18" x 18"

Model No.	Mfg. No.
SEI461 - PS	FRLVHR904XVE
SEI462 - AL	FRMVTR620VA



18" x 18"

Model No.	Mfg. No.
SEI463 - PS	LVHR907XVE
SEI464 - AL	MVTR001VA



18" x 18"

Model No.	Mfg. No.
SEI465 - PS	FRLVHR907XVE
SEI466 - AL	FRMVTR001VA



Description	Price /Each
Adhesive Vinyl - 18" x 18"	50.90
Aluminum - 18" x 18"	77.80



Take a look at our complete line of Barricade Tapes starting on page 868





# VEHICLE IDENTIFICATION



## CLASS 1

**INCOM**



A



B



C



D

Material	A. Explosive 1.1A		B. Explosive 1.1D		C. Explosive 1.4G		D. Explosive 1.5D	
	Model No.	Mfg. No.	Model No.	Mfg. No.	Model No.	Mfg. No.	Model No.	Mfg. No.
Rigid Plastic	SJ334	TT110ASS	SAH452	TT110DSS	SJ347	TT140GSS	SJ350	TT150DSS
Tagboard	SJ335	TT110ATB	SAH453	TT110DTB	SJ348	TT140GTB	SJ351	TT150DTB
Adhesive Vinyl	SD299	TT110ATB	SAH454	TT110DPS	SD301	TT140GPS	SD303	TT150DPS
Aluminum	SD300	TT110AAL	SAH455	TT110DAL	SD302	TT140GAL	SD304	TT150DAL

## CLASS 2

**INCOM**



E



F



G



H

Material	E. Flammable Gas		F. Compressed Gas		G. Poison Gas		H. Oxidizer	
	Model No.	Mfg. No.	Model No.	Mfg. No.	Model No.	Mfg. No.	Model No.	Mfg. No.
Rigid Plastic	SJ356	TT210SS	SJ358	TT220SS	SJ360	TT230SS	SJ364	TT232SS
Tagboard	SJ357	TT210TB	SJ359	TT220TB	SJ361	TT230TB	SJ365	TT232TB
Adhesive Vinyl	SD307	TT210PS	SD311	TT220PS	SD315	TT230PS	SD309	TT232PS
Aluminum	SD308	TT210AL	SD312	TT220AL	SD316	TT230AL	SD310	TT232AL

## CLASS 3



I

**INCOM**

## PLACARD PRICING

Material	I. Flammable Liquids	
	Model No.	Mfg. No.
Rigid Plastic	SJ368	TT300SS
Tagboard	SJ369	TT300TB
Adhesive Vinyl	SD319	TT300PS
Aluminum	SD320	TT300AL

Material	Price /Each
Rigid Plastic (SS)	2.00
Tagboard (TB)	0.79
Adhesive Vinyl (PS)	1.88
Aluminum (AL)	13.20



# VEHICLE IDENTIFICATION

## CLASS 4



## CLASS 5

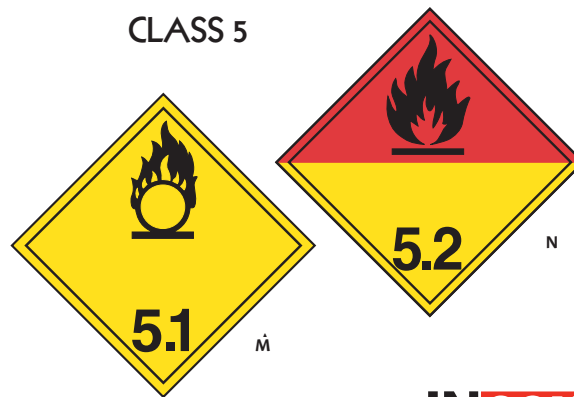

**INCOM**

Material	J. Flammable Solid		K. Spontaneously Comb.		L. Dangerous When Wet		M. Oxidizers		N. Organic Peroxides	
	Model No.	Mfg. No.	Model No.	Mfg. No.	Model No.	Mfg. No.	Model No.	Mfg. No.	Model No.	Mfg. No.
Rigid Plastic	SJ370	TT410SS	SJ372	TT420SS	SJ374	TT430SS	SJ376	TT510SS	SEC884	TT521SS
Tagboard	SJ371	TT410TB	SJ373	TT420TB	SJ375	TT430TB	SJ377	TT510TB	SEC885	TT521TB
Adhesive Vinyl	SD321	TT410PS	SD323	TT420PS	SD325	TT430PS	SD327	TT510PS	SEC886	TT521PS
Aluminum	SD322	TT410AL	SD324	TT420AL	SD326	TT430AL	SD328	TT510AL	SEC887	TT521AL

## CLASS 6



## CLASS 7



## CLASS 8



**INCOM**

Material	O. Poison, Poisonous Sub.		P. Infectious Substances		Q. Radioactive Material		R. Corrosive	
	Model No.	Mfg. No.	Model No.	Mfg. No.	Model No.	Mfg. No.	Model No.	Mfg. No.
Rigid Plastic	SJ380	TT600SS	SAG840	TT620SS	SJ384	TT700SS	SJ386	TT800SS
Tagboard	SJ381	TT600TB	SAG841	TT620TB	SJ385	TT700TB	SJ387	TT800TB
Adhesive Vinyl	SD331	TT600PS	SAG842	TT620PS	SD335	TT700PS	SD337	TT800PS
Aluminum	SD332	TT600AL	SAG843	TT620AL	SD336	TT700AL	SD338	TT800AL

## CLASS 9



**INCOM**

Material	S. Misc Dangerous Goods		T. Danger, Mixed Loads		U. Environmental Pollutant		V. Limited Quantity	
	Model No.	Mfg. No.	Model No.	Mfg. No.	Model No.	Mfg. No.	Model No.	Mfg. No.
Rigid Plastic	SJ419	TT960SS	SJ390	TT950SS	SEI890	TT166SS	SEI894	TT980SS
Tagboard	SJ420	TT960TB	SJ391	TT950TB	SEI891	TT166TB	SEI895	TT980TB
Adhesive Vinyl	SD339	TT960PS	SD345	TT950PS	SEI892	TT166PS	SEI896	TT980PS
Aluminum	SD340	TT960AL	SD346	TT950AL	SEI893	TT166AL	SEI897	TT980AL

## PLACARD PRICING

Material	Price /Each
Rigid Plastic (SS)	2.00
Tagboard (TB)	0.79
Adhesive Vinyl (PS)	1.88
Aluminum (AL)	13.20

OFFICE PRODUCTS

INSTRUMENTS, SCALES & ELECTRICAL

SHIPPING & PACKAGING

TOOLS & EQUIPMENT

WELDING & METALWORKING

SAFETY EQUIPMENT & SUPPLIES

JANITORIAL & MAINTENANCE

MATERIAL HANDLING & STORAGE

# VEHICLE IDENTIFICATION



## CLASS 1 EXPLOSIVES FLIP CHART PLACARDS

- This placard system is industry specific to the hauling of explosive substances
- This unit carries common industry explosive legends in a durable 0.31" aluminum back plate with baked-on polyester finish to resist fading
- The legends are screen printed on corrosion resistant aluminum panels
- Stainless steel spring clips are mounted to hold the pages in place and all corners are rounded for easy handling
- The base of the unit is a bright white enamel finish

### LEGENDS



**INCOM**

Model No.	Mfg. No.	Description	Price /Each
SEI900	FC7000WH	4-Legend Flip Chart	101.00



## CANADIAN 5 LEGEND FLIP CHART PLACARDS

- With 5 Canadian T.D.G. legends at your disposal, you can use this flip chart for almost any load
- Exclusive design is built for durability, heavy 0.031" white aluminum back plate for wind protection
- Baked-on polyester finish to resist fading
- Pages are made from a durable powder coated aluminum for longevity

### LEGENDS



**INCOM**

Model No.	Mfg. No.	Description	Price /Each
SAK381	FC5010WH	5-Legend Flip Chart	128.00



## FUEL FLIP CHART PLACARDS

- These popular units are enamel and comply with the new "Clear Language" Transport Canada Regulations for bulk shipments for these products
- Both pages are Class 3 Flammable Liquid
- One page has the UN number 1202, and the other page has the UN number 1203
- Units are constructed of all aluminum and stainless steel parts for added longevity

### LEGENDS



**INCOM**

Model No.	Mfg. No.	Description	Material	Price /Each
SAG845	FC4020AL	Flammable Class 3 (UN 1202)	Aluminum Base	63.80
SD357	FC4020WH	Same As Above	White Base	63.80



## CANADIAN 14 LEGEND FLIP CHART PLACARDS

- Be ready for any shipment with 13 Canadian T.D.G. legends plus a blank white page
- Exclusive design is built for durability, heavy 0.031" aluminum back plate for wind protection
- Baked-on polyester finish to resist fading
- Pages are made from a durable powder coated aluminum for longevity

### LEGENDS

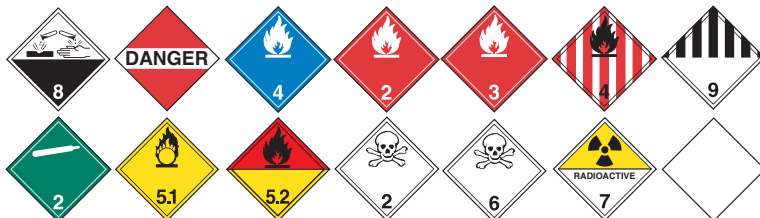

**INCOM**

Model No.	Mfg. No.	Description	Price /Each
SAK382	FC5000WHR	14-Legend Flip Chart	216.00



854

MATERIAL HANDLING & STORAGE

JANITORIAL & MAINTENANCE

SAFETY EQUIPMENT & SUPPLIES

WELDING & METALWORKING

TOOLS & EQUIPMENT

SHIPPING & PACKAGING

INSTRUMENTS, SCALES & ELECTRICAL

OFFICE PRODUCTS

# VEHICLE IDENTIFICATION

## DANGEROUS GOODS SHIPPING LABELS 4" X 4" (100 MM X 100 MM)

Priced per Roll

- Shipping labels are essential for packages that contain dangerous goods
- Labels are available in two materials, paper for indoor applications and vinyl for extended outdoor usage
- Manufactured to Transport Canada specifications with fade resistant inks
- 500 labels/roll

Material	Price /Each
Paper	32.90
Vinyl	52.00

### CLASS 2



### CLASS 3



**INCOM**

Material	Flammable Gas		Compressed Gas		Poison Gas		Oxidizer		Flammable Liquids	
	Model No.	Mfg. No.	Model No.	Mfg. No.	Model No.	Mfg. No.	Model No.	Mfg. No.	Model No.	Mfg. No.
Paper	SAG852	TT21P	SAG854	TT22P	SAG856	TT23P	SAG858	TT50P	SAG860	TT30P
Vinyl	SAG853	TT21V	SAG855	TT22V	SAG857	TT23V	SAG859	TT50V	SAG861	TT30V

### CLASS 4



### CLASS 5



**INCOM**

Material	Flammable Solid		Spontaneously Comb.		Dangerous When Wet		Oxidizers		Organic Peroxides	
	Model No.	Mfg. No.	Model No.	Mfg. No.	Model No.	Mfg. No.	Model No.	Mfg. No.	Model No.	Mfg. No.
Paper	SAG862	TT41P	SAG864	TT42P	SAG866	TT43P	SAG868	TT51P	SED444	TT53P
Vinyl	SAG863	TT41V	SAG865	TT42V	SAG867	TT43V	SAG869	TT51V	SED445	TT53V

### CLASS 6



### CLASS 7



**INCOM**

Material	Poison, Poisonous Sub.		Infectious Substances		Radioactive I		Radioactive II		Radioactive III	
	Model No.	Mfg. No.	Model No.	Mfg. No.	Model No.	Mfg. No.	Model No.	Mfg. No.	Model No.	Mfg. No.
Paper	SAG872	TT60P	SAG874	TT63P	SAG876	TT71P	SAG878	TT72P	SAG880	TT73P
Vinyl	SAG873	TT60V	SAG875	TT63V	SAG877	TT71V	SAG879	TT72V	SAG881	TT73V

### CLASS 8



### CLASS 9



### MARKS



### LIMITED QUANTITY



**INCOM**

Material	Corrosive		Misc. Dangerous Goods		Environmental Pollutant		Limited Quantity	
	Model No.	Mfg. No.	Model No.	Mfg. No.	Model No.	Mfg. No.	Model No.	Mfg. No.
Paper	SAG882	TT80P	SAG884	TT91P	SAK383	TT74P	SEI898	TT98P
Vinyl	SAG883	TT80V	SAG885	TT91V	SAK384	TT74V	SEI899	TT98V



# PARKING & HIGHWAY

## SAFETYWHIPS USA - FIELD PROVEN, HIGH VISIBILITY PRODUCTS

### LIGHT-DUTY, HEAVY-DUTY AND SUPER-DUTY WARNING WHIPS

- Multiple pole, whip light and mount option
- Temporary or permanent mounting
- Internationally proven technology and quality
- Be seen, stay safe!



### SAFETY WHIPS

- 11.5" x 11.5" mesh flag

Model No.	Length'	Base	Flag	Price /Each
<b>LIGHT-DUTY</b>				
SDP028	5	Magnet	Orange	75.00
SDP029	5	Magnet	Orange w/Reflective X	88.40
SDP031	5	Window Mount	Orange w/Reflective X	149.00
<b>HEAVY-DUTY - NON-POWERED</b>				
SDN979	5	Threaded	Orange	54.60
SDN990	5	Threaded	Orange w/Reflective X	68.10
SDN981	8	Threaded	Orange	74.30
SDN980	8	Threaded	Orange w/Reflective X	87.70
SDN982	10	Threaded	Orange	85.20
SDN991	10	Threaded	Orange w/Reflective X	98.70
<b>HEAVY-DUTY - POWERED</b>				
SDN998	5	Threaded	Orange	87.70
SDN995	5	Threaded	Orange w/Reflective X	102.00
SDN993	8	Threaded	Orange	106.00
SDN996	8	Threaded	Orange w/Reflective X	119.00
SDN997	10	Threaded	Orange	121.00
SDN985	10	Threaded	Orange w/Reflective X	135.00

### LIGHTING OPTIONS FOR HEAVY-DUTY SAFETY WHIP - POWERED

Model No.	Description	Colour	Price /Each
SDP019*	High Impact Plastic Lens	Amber	14.10
SDN987	Low Profile - Sealed, Non-Flash LED	Amber	39.30
SDP010	Low Profile - Sealed, Non-Flash LED	White	39.30
SDP024	Non-Flash 8 LED	Amber	33.10
SDP025	Non-Flash 8 LED	Red	33.10
SDP023	Flash 8 LED	White	33.10
SDP020	Quad-Flash, 6 LED	Amber	78.60
SDP021	Quad-Flash, 6 LED	White	78.60

\* Miniature lamps sold separately

### ACCESSORIES FOR HEAVY-DUTY SAFETY WHIP

Model No.	Mfg. No.	Description	Price /Each
<b>FOR NON-POWERED WHIPS</b>			
SDP006	519.30BNP	Heavy-Duty Spring Mount	44.80
SDP583	ABM	Angle Bracket Mount	32.40
SDP584	SPM	Stake Pocket Mount	152.00
SDP582	HM1NP	Hitch Mount	106.00
<b>FOR POWERED WHIPS</b>			
SDN978	519.30B	Heavy-Duty Spring Mount	63.50
SDP027	ABM/RCA	Angle Bracket Mount	38.80
SDP026	SPM/RCA	Stake Pocket Mount	165.00
SDN988	HM1	Hitch Mount	140.00
SDP012	519.33LHR	Magnet Mount, Handle & Cigarette Cord	163.00

### SUPER-DUTY PERMANENT MOUNT SAFETY WHIPS

- Complete whip assembly: Orange 16" x 16" flag with reflective X, heavy-duty spring and low profile - sealed, non flash LED

Model No.	Description	Price /Each
SDN984	6' Safety Whip w/White LED	233.00
SDP015	8' Safety Whip w/Amber LED	245.00



SDP023

SDP024

SDP019

### ACCESSORIES FOR HEAVY-DUTY SAFETY WHIP

Model No.	Mfg. No.	Description	Price /Each
<b>FOR NON-POWERED WHIPS</b>			
SDP006	519.30BNP	Heavy-Duty Spring Mount	44.80
SDP583	ABM	Angle Bracket Mount	32.40
SDP584	SPM	Stake Pocket Mount	152.00
SDP582	HM1NP	Hitch Mount	106.00
<b>FOR POWERED WHIPS</b>			
SDN978	519.30B	Heavy-Duty Spring Mount	63.50
SDP027	ABM/RCA	Angle Bracket Mount	38.80
SDP026	SPM/RCA	Stake Pocket Mount	165.00
SDN988	HM1	Hitch Mount	140.00
SDP012	519.33LHR	Magnet Mount, Handle & Cigarette Cord	163.00

### SUPER-DUTY PERMANENT MOUNT SAFETY WHIPS

- Complete whip assembly: Orange 16" x 16" flag with reflective X, heavy-duty spring and low profile - sealed, non flash LED

Model No.	Description	Price /Each
SDN984	6' Safety Whip w/White LED	233.00
SDP015	8' Safety Whip w/Amber LED	245.00



SDP584

SDP012



SDP006



SDP027



SDN984



## QUADRAFLEX ROLL-UP SIGNS

- Temporary traffic control signs for construction, work zones and emergency traffic control
- Meets NCHRP-350 Certification and MUTCD standards
- Designed with technology to increase sign detection, especially in low-light conditions
- Designed with micro-prismatic reflective sheeting bonded to a heavy-duty fibre-reinforced vinyl material
- Will not delaminate and provides outstanding durability, legibility and long sign life
- Signs will not wrinkle or crinkle and will maintain its legibility after multiple uses
- Easy to transport



Model No.	Mfg. No.	Legend	Price /Each
<b>60 CM (23 3/5") X 75 CM (29 1/2")</b>			
SDP373	07-800-35102	Ligne D'Arrêt w/Arrow	141.00
<b>75 CM (29 1/2") X 75 (29 1/2")</b>			
SDP367	07-800-0123	Men at Work Pictogram	141.00
SDP368	07-800-0124	Arrow	141.00
SDP369	07-800-0135	Merge Left Pictogram	141.00
SDP370	07-800-0136	Yield Ahead Pictogram	216.00
SDP372	07-800-35101	Do Not Pass Pictogram	216.00
SDP374	07-800-35103	Stop Light Pictogram	141.00
SDP375	07-800-35104	Man In Bucket Pictogram	141.00
SDP376	07-800-35105	Flagman Pictogram	141.00
SDP377	07-800-35106	Lentement	141.00
SDP566	07-800-0137	Merge Right Pictogram	141.00
<b>90 CM (36") X 90 CM (36")</b>			
SDP359	07-800-3026-L	Men at Work Pictogram	185.00
SDP360	07-800-3028-L	Construction w/Upwards Arrow	185.00
SDP361	07-800-3044-L	Merge Right Pictogram	185.00
SDP362	07-800-3045-L	Merge Left Pictogram	185.00
SDP363	07-800-3051-L	Flagman Pictogram	185.00
SDP366	07-800-3060-L	Arrow	203.00
SDP378	07-800-3058-L	Yield Ahead Pictogram	231.00
SDP371	07-800-30104	Emergency Scene Ahead	185.00
<b>90 CM (36") X 120 CM (48")</b>			
SDP364	07-800-3056-L	Yield Pictogram to Oncoming Traffic	277.00
SDP365	07-800-3057-L	Road Closed Pictogram	277.00

Model No.	Mfg. No.	Description	Price /Each
<b>QUADRAFLEX ROLL-UP SIGN STANDS</b>			
SDP357	07-804-1	W/Roll-Up Bracket	324.00
SDP358	07-804-3	W/Telescoping Mast	336.00



23-3/5" x 29-1/2"  
SDP373



36" x 48"  
SDP364



36" x 48"  
SDP365

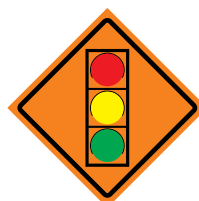

29-1/2" x 29-1/2"  
SDP374



29-1/2" x 29-1/2"  
SDP375



29-1/2" x 29-1/2"  
SDP372



29-1/2" x 29-1/2"  
SDP369



36" X 36"  
SDP362



29-1/2" x 29-1/2"  
SDP367

36" X 36"  
SDP359



29-1/2" x 29-1/2"  
SDP376



29-1/2" x 29-1/2"  
SDP378

36" X 36"  
SDP368



29-1/2" x 29-1/2"  
SDP377



36" X 36"  
SDP360



36" X 36"  
SDP371

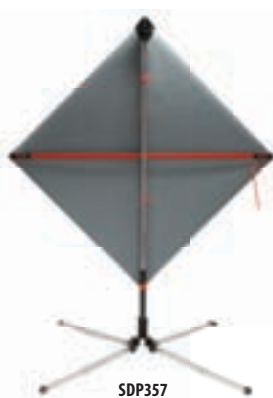



## TRAFFIC SAFETY FLAGS

- For use as hand or vehicle flags
- Comes with 24" or 36" wooden staff
- Use 36" wooden staff model with moving vehicles
- Flag size: 18" x 18"
- Available in mesh, vinyl or throw away vinyl
- Mesh flag: Heavy-duty fluorescent with plastic trim; resists tearing, fraying or snagging
- Vinyl flag: Fluorescent vinyl blend with heat-sealed hem
- Throw away vinyl flag sold as a case of 100
- Colour: Red/Orange

Model No.	Mfg. No.	Description	Wooden Staff"	Price /Each
<b>FLAG WITH STAFF</b>				
SC140	03-229-3406	Mesh Flag	24	5.63
SC141	03-229-3463	Mesh Flag	36	7.44
SAP711	03-229-3417	Vinyl Flag	24	4.32
SC143	03-229-3405	Vinyl Flag	36	5.23
<b>FLAG ONLY</b>				
SAI342	03-229-3412	Mesh Flag	-	4.02
SEI553	03-229-3472	Throw Away Vinyl Flag	-	32.30



## ELECTRONIC LED SAFETY BATONS

- Pulsating high intensity LED lights
- Water and impact resistant construction
- 3 flash modes: steady on, slow flash and fast flash
- Takes C-cell batteries (XB874), batteries not included
- Length: 12"

Model No. SDP537  
Price/Each \$27.10



## TRAFFIC CONTROL SIGNS

- Double-sided hand-held traffic sign
- Directs traffic by signaling the desired warning towards oncoming vehicles
- STOP legend red with white legend and border
- SLOW legend fluorescent yellow/green with black legend and border
- Size: 18" x 18"
- Optional 81" orange plastic handle sold separately



## MUNICIPAL TRAFFIC SIGNS

- Octagon shaped paddle sign
- Engineer grade reflective material
- Ideal for school crossing guards and low speed construction areas
- English version available with a 18" sign and 9" plastic polygrip handle included
- French version available with a 15" sign and a 10" aluminum handle with rubber grip
- Meets MUTCD regulations



Model No.	Mfg. No.	Description	Price /Each
SEI474	03-855	STOP/STOP Sign w/handle	56.60
SEI475	03-852	STOP/SLOW Sign w/handle	49.30
SC504	PTF001P	ARRÊT/ARRÊT Sign w/handle	27.80
SC505	PTF002P	ARRÊT/LENTEMENT Sign w/handle	27.80

Model No.	Mfg. No.	Description	Type	Price /Each
SEJ663	03-836	STOP/SLOW Sign – MUTCD regulated	Hi-intensity	94.60
SO101	03-8580N	STOP/SLOW Sign – MTO TC-22 regulated	Hi-intensity	100.00
SEI644	03-824	81" Plastic Handle	-	28.80

## HIGHWAY BANNERS

- Screened "WIDE LOAD" on one side and "OVERSIZE LOAD" on reverse, made of durable material
- Black on yellow 18" x 96" complete with 5' tie down ropes

Model No.	Mfg. No.	Description	Size		Price /Each
			W"	x H"	
SC150	03-11-000	Wide Load/Oversize Load	96	x 18	28.70

**WIDE LOAD**

**OVERSIZE LOAD**

## TRUCK "D" BANNER ROLL UP SIGNS

- Made using durable Level 1 Hi-Intensity Retro Reflective material
- Ideal for day and night time hauling
- Meets and exceeds all provincial regulations
- 10 heavy duty grommets; 5 upper and 5 lower

Model No.	Height"	Width"	Price /Each
SDP621	45.72 cm (18")	243.84 cm (96")	245.00



## SLOW MOVING VEHICLE SIGNS

Available in two styles. Heavy duty, aluminum backed triangle mounts easily using screwholes provided. Self-adhesive decal triangle mounts quickly to any smooth, clean surface. Meets all provincial and federal specifications.

Model No.	Mfg. No.	Description	Price /Each
SC153	05-099-10	Aluminum Sign	22.60
SC154	TTR006-AC	Self-Adhesive Sign	31.60



## TRIANGULAR REFLECTOR KITS

### INDUSTRIAL

#### TRIANGULAR REFLECTOR KIT

- Set of 3 triangular reflectors in reusable storage container
- Constructed of molded polypropylene plastic with red acrylic plastic reflectors
- Air-flow design helps reduce wind resistance
- Meets FMVSS-125 Standards



SAV007

Model No.	Mfg. No.	Description	Price /Each
SAV007	95-03-009	Industrial Kit	34.80

## SAFETY FLARES

- Visible in fog, rain, or snow
- Easy to ignite with self-contained striker
- 20 or 30-minute duration
- Spike or wire stands available
- UL approved



Priced per Package

Model No.	Mfg. No.	Description	Qty /Pkg.	Price /Each
<b>20 MINUTES</b>				
SAI373	2720	Spike	72	397.00
SAI374	9240	Wire stand	72	462.00
<b>30 MINUTES</b>				
SAI375	2730	Spike	36	259.00
SAI376	9340	Wire stand	36	303.00



### FLARE CONTAINERS

Model No.	Mfg. No.	Description	Price /Each
SDP618*	300	Holds up to four 20 minute Flares	46.70
SDP619*	S300	Holds up to four 30 minute Flares	50.20
SDP620	7830	Holds up to eighteen 30 minute Flares	42.30

\* Wall Mounting bracket included

SDP618





## 6" CYALUME® LIGHTSTICKS

Provides a light source more dependable than flashlights and safer than flares or candles.

- Convenient, safe emergency back-up lighting for applications at night, in confined space or in blackout
- Lightsticks visible even in dense smoke
- Just bend, snap and shake for instant light
- Non-toxic, non-flammable and weatherproof
- Regular and hi-intensity products available
- 6" length ideal for vehicle identification markers, maintenance/refueling lights, route markers and disaster preparedness lights



Model No.	Mfg. No.	Colour	Price /Each
<b>12 HOURS</b>			
SAK740	27017	Green	3.47
SAK741	27054	Red	3.47
SAK742	27020	Yellow	3.47
SAK743	27019	Orange	3.47
<b>8 HOURS</b>			
SAK744	27078	White	3.47
SAK745	27077	Blue	3.47

**OmniGlow™**



Model No.	Mfg. No.	Colour	Price /Each
<b>30-MINUTE HI-INTENSITY</b>			
SAK746	27061	Yellow	3.47
SAK747	27021	White	3.47
SAK748	27063	Red	3.47

## SPEED BUMPS

- 1-piece lightweight 100% recycled rubber
- Resistant to corrosion, moisture, oil and weather variations
- Perfect for speed reduction in parking lots, school zones and areas with heavy pedestrian traffic
- Black with bright yellow reflective stripes for maximum daytime visibility
- Reflectors offer maximum night time visibility
- Easily installed with 14" rebar spike for permanent or temporary installation
- 11" W x 2 1/4" H

Model No.	Length	Spikes Required	Weight lbs.	Price /Each
<b>SPEED BUMP</b>				
SEH142	4'	5	35	98.00
SEH143	6'	4	55	138.00
<b>REBAR SPIKE</b>				
SEH144	14"	-	-	5.50



**ZENITH®**  
Safety Products

## SPEED BUMPS

- Lightweight, durable speed bump is designed to help keep speed levels down
- Made with 100% recycled plastic, they are impervious to road chemicals and corrosion
- Molded-in colour, which eliminates the need for painting traffic marks
- Dirt is easily removed with either soap and water or a commercial solvent
- Lightweight; 3-bolt anchoring system facilitates relocation
- They are modular and therefore can be installed side by side with others to make 6, 9, 12 etc. feet assemblies
- Hardware included
- Colour: Safety yellow

### SPECIFICATIONS:

Dimensions: 36" L x 10 1/2" W x 2" H  
Securing Holes: Countersunk 1/2" diameter

Model No.	Length'	Wt. lbs.	Price /Each
SEC432	3	35	80.30



**IRONGuard**  
Protecting Your People



## CAR STOPS

- Durable, bring order to parking lots
- Solid colouring throughout means they never need painting and will retain an attractive appearance
- Made with 100% recycled plastic, they are protected against damages brought on by road chemicals, deterioration and corrosion, eliminating the danger of exposed reinforcing rods seen in traditional concrete car stops
- Predrilled and can be installed by one person
- Hardware sold separately
- 6' lengths available in safety yellow, handicap blue and cement grey
- 4' length available in safety yellow only

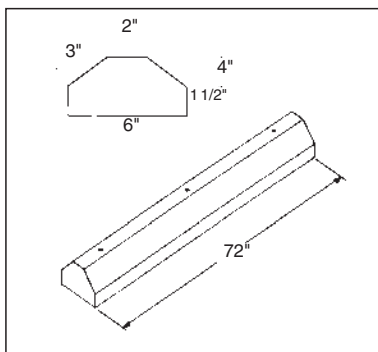

		4'	6'
<b>Hardware:</b>	- 1/2" x 8" lag screws	2	3
	- 9/16" washers	2	3
	- Expanding nylon anchors	3	3
<b>Securing holes:</b>	Countersunk 1/2" diameter		

Yellow Model No.	Mfg. No.	Blue Model No.	Mfg. No.	Grey Model No.	Mfg. No.	Length'	Wt. lbs.	Price /Each
<b>CAR STOPS</b>								
SE102	7040	-	-	-	-	4	29.5	107.00
SE105	7050	SE106	7052	SE107	7053	6	41.5	150.00

Model No.	Mfg. No.	Description	Wt. lbs.	Price /Each
<b>HARDWARE</b>				
SE108	7056	For 4' Car Stops	1	16.20
SE109	7055	For 6' Car Stops	1	19.10

## PARKING CURBS

- 1-piece lightweight 100% recycled rubber
- Resistant to corrosion, moisture, oil and weather variations
- Safer and more durable than concrete or plastic; will not chip, crack or deform
- Black with bright yellow reflective stripes for maximum visibility
- Easily installed with 14" rebar spike for permanent or temporary installation
- 6" W x 4" H



Model No.	Length	Spikes Required	Weight lbs.	Price /Each
<b>PARKING CURB</b>				
SEH140	3'	3	20	39.95
SEH141	6'	4	35	69.95
<b>REBAR SPIKE</b>				
SEH144	14"	-	-	5.50