

OBEDIENCE TRIAL RULES & REGULATIONS

Effective January 1, 2012



CANADIAN KENNEL CLUB

CLUB CANIN CANADIEN

PURPOSE

The purpose of obedience trials is to demonstrate the usefulness of the purebred dog as a companion of man, not merely the dog's ability to follow specified routines in the obedience ring. The basic objective of obedience trials is to produce dogs that have been trained to behave in the home, in public places, and in the presence of other dogs, in a manner that reflects credit on the sport of obedience.

Obedience trials are a sport and all participants should be guided by the principles of good sportsmanship both inside and outside the ring. All contestants in a class are required to perform the same exercises in substantially the same way so that the relative quality of the various performances may be compared and scored.

TABLE OF CONTENTS

1	INTERPRETATIONS	
1.1	Definitions.....	1
1.2	Obedience Trials Defined & Classified	3
2	GENERAL RULES & REGULATIONS	
2.1	Eligibility of Clubs to Hold Obedience Trials.....	4
2.2	Making Application	4
2.3	CKC Publications	5
2.4	Advertising	5
2.5	Officials & Committees	5
2.6	Ring Stewards	6
2.7	Veterinarian.....	6
3	JUDGES	
3.1	Application for Approval of Judges.....	7
3.2	Judge's Eligibility	7
3.3	Contract Between a Club and a Judge	8
3.4	Substitute & Replacement Judges	9
3.5	Judges Entering or Handling Dogs.....	10
3.6	Indignities to a Judge	10
3.7	Judge's Conduct	10
4	PREMIUM LIST, CATALOGUE & JUDGING SCHEDULE	
4.1	Premium List	11
4.2	Catalogue	12
4.3	Judging Schedule.....	12
4.4	Limited Entries	14
5	RIBBONS & PRIZES	
5.1	Ribbons & Rosettes	15
5.2	Prizes & Trophies.....	15
6	ENTRIES & END OF TRIAL	
6.1	Entry Requirements.....	16
6.2	Entry Forms	18
6.3	Entry Fees.....	19
6.4	Dogs Must Compete	20
6.5	Bitches In Season	20
6.6	Health	20
6.7	Trial Venue & Precincts	21
6.8	Class Eligibility	21
6.9	Moving Up	22
6.10	End of the Trial	23

7	UNSPORTSMANLIKE CONDUCT	23
8	REGULATIONS FOR PERFORMANCE & JUDGING	
8.1	Judging Standard	24
8.2	Excusal, Disqualification & Reinstatement of a Dog.....	25
8.3	Handlers with Disabilities	26
8.4	Qualifying Performance	27
8.5	Judge's Orders & Signals	28
8.6	Catalogue Order	29
8.7	Judge's Book	29
8.8	Re-Judging	30
8.9	Ties	30
8.10	Scoresheets	30
8.11	Announcement of Scores	31
8.12	Explanations & Errors	31
8.13	Ring Procedure	31
8.14	Commands & Signals	33
8.15	Praise, Food & Petting	34
8.16	Leash & Collar & Jacket.....	34
8.17	Heel Position	35
8.18	Group Exercises	35
8.19	Rings & Equipment	35
8.20	The High Jump	36
8.21	The Broad Jump	36
8.22	The Bar Jump	37
9	PRE-NOVICE CLASS	
9.1	Pre-Novice	37
9.2	Tests, Order of Judging	38
9.3	Pre-Novice Title (P.C.D.).....	38
9.4	Extra Commands or Signals	39
9.5	Heel on Leash	39
9.6	Figure 8.....	40
9.7	Sit for Examination	40
9.8	Recall	41
9.9	Group Sit Exercise.....	42
10	NOVICE CLASS	
10.1	Novice A	43
10.2	Novice B	43
10.3	Novice C	43
10.4	Tests, Order of Judging & Scores	44
10.5	Companion Dog Title (C.D.).....	44
10.6	Heel On Leash & Figure 8.....	45

10.7	Stand for Examination	46
10.8	Heel Free	47
10.9	Recall	47
10.10	Group Sit & Down Exercises	48
11	NOVICE INTERMEDIATE CLASS	
11.1	Novice Intermediate Class	50
11.2	Tests, Order of Judging & Scores for Novice Intermediate	50
11.3	Novice Intermediate (C.D.I.)	50
11.4	Heel Free & Figure 8	51
11.5	Stand for Examination	51
11.6	Drop from Heel	52
11.7	Recall Holding the Dumbbell	52
11.8	Recall Over High Jump Holding the Dumbbell	53
11.9	Broad Jump	54
12	OPEN CLASS	
12.1	Open A	55
12.2	Open B	55
12.3	Tests, Order of Judging & Scores for Open A ..	56
12.4	Tests, Order of Judging & Scores for Open B ..	56
12.5	Companion Dog Excellent Title (C.D.X.) ..	58
12.6	Heel Free	58
12.7	Drop On Recall	59
12.8	Retrieve On Flat	59
12.9	Retrieve Over High Jump	60
12.10	Broad Jump	61
12.11	Group Sit & Down Exercises	62
13	UTILITY CLASS	
13.1	Utility Class A	62
13.2	Utility Class B	63
13.3	Tests, Order of Judging & Scores for Utility A ..	63
13.4	Tests, Order of Judging & Scores for Utility B ..	64
13.5	Utility Dog Title (U.D.)	65
13.6	Seek Back	66
13.7	Scent Discrimination	67
13.8	Signal Exercise	69
13.9	Moving Stand & Examination	70
13.10	Directed Jumping	71
14	OBEDIENCE TRIAL CHAMPIONSHIPS	
14.1	Obedience Trial Champion	72
14.2	Obedience Trial Champion Excellent	72

14.3	Master Obedience Trial Champion	73
14.4	Grand Master Obedience Trial Champion	73
15	EXHIBITION ONLY CLASS	
15.1	Exhibition Only	74
16	UNOFFICIAL CLASSES	
16.1	Unofficial Classes	74
16.2	Graduate Novice Class	75
16.3	Graduate Open Class.....	76
16.4	Versatility Class	78
16.5	Brace Class	79
16.6	Team Class	80
16.7	Veteran's Class.....	83
16.8	Parade of Title Holders & Parade of Veterans	84
17	SANCTIONED OBEDIENCE MATCHES	84
18	PROTESTS	86
19	COMPLAINTS	87
20	DISCIPLINE	88
21	PROCEDURE FOR CONDUCTING AN OBEDIENCE TRIAL COMMITTEE HEARING	90
22	PARTICIPATION	91
23	NO LIABILITY	92
24	AMENDMENTS	92
APPENDIX		
A	OBEDIENCE TRIAL SAMPLE JUDGING CHARTS FOR PRE-NOVICE, NOVICE, NOVICE INTERMEDIATE, OPEN & UTILITY	93
B	PREMIUM LIST.....	100
C	CATALOGUE	101
D	END OF TRIAL	103
E	CONSTRUCTION SPECIFICATIONS (DETAILS OF JUMPS)	104
F	BREED SPECIFICATIONS (RETRIEVE OVER HIGH JUMP)	107
G	JUMP HEIGHTS	108

1 INTERPRETATIONS

1.1 Definitions

For the purpose of these rules and regulations, the following interpretations shall apply:

“Board” means the Board of Directors of The Canadian Kennel Club

“breed” means a breed that is accepted by a recognized foreign stud book or by an association incorporated under the Animal Pedigree Act other than the CKC;

(39-09-11) **“C.D.”** means Companion Dog

(39-09-11) **“C.D.I.”** means Companion Dog Intermediate

(39-09-11) **“C.D.X.”** means Companion Dog Excellent

“CKC” means The Canadian Kennel Club

“Club” means The Canadian Kennel Club

“club” means a club or association officially recognized by The Canadian Kennel Club

“complainant” means any person who has laid a charge or complaint against another person, partnership, company or organization relative to the contravention of these rules, regulations, procedures and policies of The Canadian Kennel Club

“debar” means to prohibit a person from participating in any competition or other activities directed, sanctioned, sponsored or authorized by The Canadian Kennel Club if held under its auspices or under any of its rules and regulations

“defendant” means any person, partnership, company or organization against whom a charge or complaint has been laid, relative to the contravention of these rules, regulations, procedures and policies of The Canadian Kennel Club

“deprive of privileges” means to deprive a non-member of all privileges accorded to non-members of The Canadian Kennel Club, including the use of the Head Office

“dog” means a purebred dog of either sex

“exhibitor” means the owner(s) or handler who enters a dog at a trial

“expel” means to terminate membership in The Canadian Kennel Club and depriving the person so expelled from all privileges of The Canadian Kennel Club

(39-09-11) **“G.M.O.T.Ch”** means Grand Master Obedience Trial Champion

“good standing” means an individual who is not under suspension, deprivation, debarment or who has not forfeited his right to participate in any Canadian Kennel Club approved event

“handler” means the person who handles a dog in the obedience trial

“Head Office” means the office at which the business of The Canadian Kennel Club is carried out on a regular ongoing basis

(39-09-11) **“H.I.T.”** means High in Trial

“immediate family” means spouse, father, mother, son, daughter, brother, sister, grandparents and significant other

“just cause” means how a reasonable person without personal bias or prejudice would act

“lame” means any condition which affects a dog’s locomotion. A dog with a withered or amputated limb is considered to be moving with unnatural locomotion

“listed breed” means a breed that is included in the Miscellaneous List and that is authorized to participate in CKC events in accordance with the rules and regulations governing those events

(39-09-11) **“minor deduction”** is less than 2 points.

(39-09-11) **“M.O.T.Ch”** means Master Obedience Trial Champion

“owner” means the owner or owners as stated on the registration certificate of the dog

(39-09-11) **“OTCh”** means Obedience Trial Champion

“O.T.Ch.X” means Obedience Trial Champion Excellent

(39-09-11) **“pair”** is a qualifying score in both the Open B and Utility B classes at the same trial.

(39-09-11) **“P.C.D.”** means Pre-Companion Dog

(39-09-11) **“precincts”** means a defined area of the venue where the activities of the official event will take place.

“recognized breed” means a breed that The Canadian Kennel Club is authorized to register in accordance with the Animal Pedigree Act

(39-09-11) **“substantial deduction”** is 2 points or more

“suspend” means to deprive a member, for the period ordered, of all the privileges of The Canadian Kennel Club

(39-09-11) **“U.D.”** means Utility Dog

(39-09-11) **“venue”** means the premises used by the club(s) over one or more days for all functions associated with the event(s)

(39-09-11) **“withers”** the highest point of the dog’s shoulder.

This rule book shall be read with all applicable changes in gender so that the masculine shall include the feminine and vice versa and the singular shall include the plural if applicable.

1.2 Obedience Trials Defined & Classified

1.2.1 An approved obedience trial is a formal event given by a CKC accredited club at which qualifying scores may be awarded towards a title.

1.2.2 A sanctioned obedience match is an informal event given by a CKC accredited club at which dogs compete but do not earn qualifying scores towards titles.

1.2.3 When an Obedience Trial and/or a Rally Obedience trial is held in conjunction with a Conformation Show, the Conformation rules, where applicable shall govern the conduct of these trials and shall apply to all dogs and persons participating in them, except as these Rules and Regulations may otherwise provide.

2 GENERAL RULES & REGULATIONS

2.1 Eligibility of Clubs to Hold Obedience Trials

- 2.1.1 Only CKC accredited clubs or associations in good standing with the CKC are eligible to apply for and hold an obedience trial.
- 2.1.2 A club that has not held an approved obedience trial under CKC regulations within the past 3 years will be required to hold 3 sanctioned obedience matches in not less than a 12 month period and not more than a 24 month period before permission will be granted to hold an approved obedience trial. Sanctioned obedience match dates must be a minimum of 90 days apart. At each of these 3 sanctioned obedience matches, members of the club conducting the match must hold all official positions, and all of the duties of such officials, including all preparation and organization for the match, must be performed by these officials.
- 2.1.3 A specialty club holding a specialty championship show under CKC rules may apply for and be granted permission to hold an approved specialty obedience trial under these regulations in conjunction with its specialty championship show. The trial may be confined to the breed or breeds eligible for entry in its specialty show, or the club may apply for a group or an all-breed obedience trial if it meets the prescribed requirements.

2.2 Making Application

- 2.2.1 A club or association applying to hold an obedience trial must make application on a form provided by the CKC. The Event Date Application must be submitted and received not less than 180 days before the date of the proposed trial. The CKC will notify the club whether or not approval has been granted. If the date is granted and the club fails to hold its trial on the date approved, an administrative fee as set by the Board will be assessed against the club, unless the CKC waives this fee on the grounds that the club had no alternative but to postpone or cancel.
- 2.2.2 The Event Secretary must be a regular member in good standing with the CKC.

2.2.3 The CKC shall have the authority to grant or withhold approval of an application for trial dates. In the event approval is withheld, the trial-giving club shall have no claim against the CKC.

2.2.4 A club may hold a sanctioned obedience match by obtaining the authorization of the CKC. Sanctioned obedience matches shall be governed by the regulations contained in these rules and regulations. Scores attained at a sanctioned obedience match shall not be considered as “qualifying” or as a “leg” towards a title.

2.3 CKC Publications

2.3.1 All clubs holding Obedience Trials are required to have the latest edition of these Obedience Trial Rules & Regulations available at the trial.

2.4 Advertising

2.4.1 A club that has not been granted priority dates must not advertise or publish the date of any event that has not been approved by the CKC.

2.4.2 A club that has been granted priority dates for its event may advertise those dates prior to submitting the Event Date Application. This does not exempt the club from submitting the required applications to the CKC within the prescribed time frame.

2.4.3 A club must not advertise the names of the judges until the club has received official notification from the CKC that the judges have been approved.

2.5 Officials & Committees

2.5.1 Only those persons in good standing with the CKC may act in any official capacity at obedience trials.

2.5.2 Trial Secretaries, Superintendents and Trial Chairs may not handle a dog at any trial in which they are acting as an official.

2.5.3 Any club holding an obedience trial under these rules must name a trial secretary who must be a member in good standing with the CKC. The premium list for CKC approved obedience trials shall designate the trial secretary as the person who is to receive entries.

2.5.4 A trial-giving club must appoint an Obedience Trial Committee and this committee shall exercise all the authority vested in a Conformation Show Committee. This Committee shall consist of a trial secretary, a trial chairperson, a chief ring steward and any other position the club deems necessary. When an obedience trial is held in conjunction with a conformation show, the Club needs only to appoint a trial chair who will be a member of the Conformation Show Committee and advise that Committee on matters related to the obedience trial.
(136-09-11)

2.5.5 The decision of the Obedience Trial Committee (or the Conformation Show Committee if the trial is held in conjunction with a show) shall be conclusive on all matters arising at the trial and shall bind parties subject to the By-laws of the CKC. In cases when an obedience trial is held in conjunction with a conformation show, only the Obedience Trial Rules & Regulations will bind all dogs entered in obedience competition.

2.6 Ring Stewards

2.6.1 It shall be the sole duty of the ring stewards to assist the judge, only as instructed by the judge. Ring Stewards must ensure that no person except the obedience trial chair, superintendent, trial secretary, judge, other ring stewards, and those actually engaged in exhibiting a dog before the judge, are permitted within the ring during judging.

2.6.2 Stewards shall not give information or instructions to owners and/or handlers, except as specifically instructed by the judge, and in such a manner that it is clear that the instructions are those of the judge.
(24-09-11)

2.6.3 There must be a minimum of 2 stewards for each judging ring, at least one of which should be experienced.
(24-09-11)

2.7 Veterinarian

2.7.1 Every obedience trial shall have one or more qualified veterinarians in attendance before and during the entire progress of the trial, or within easy call.

3 JUDGES

3.1 Application for Approval of Judges

- 3.1.1 After a club has been granted permission by the CKC to hold an Obedience Trial, the club must submit a Judging Panel Application. The application must be submitted so as to be received not less than 120 days prior to the date of the trial. The application must set forth the names and addresses of the persons selected to judge as well as the classes assigned to each judge.
- 3.1.2 When the Judging Panel Application reaches the CKC less than 120 days prior to the trial, an administrative fee as set by the Board will be assessed against the club.
- 3.1.3 The club shall not select any judge who is ineligible to officiate at a trial held under these rules and regulations.
- 3.1.4 Once approval is granted, the CKC will inform the trial-giving club that the judges have been approved. The trial secretary shall send to each approved judge a confirmation of assignment letter, supplied by the CKC as well as any other pertinent information that the club may include.
- 3.1.5 If the CKC is not prepared to approve a selected judge, or it is not prepared to approve the entire assignment for which a judge has been selected, the club must submit to Head Office of The Canadian Kennel Club the name or names of an alternative judge(s) for those classes or trials.
(26-09-11)
- 3.1.6 Once a panel of judges has been approved by the CKC, no change will be permitted except when necessary (i.e. due to death or illness) and with CKC permission.

3.2 Judge's Eligibility

- 3.2.1 The Board has the authority to do any or all of the following from time to time as it deems advisable:
(27-09-11)
- (a) Prescribe and enforce regulations, policies and procedures, with a view to determining the qualifications of those wishing to establish eligibility to

judge at approved obedience trials (Policy & Procedures Manual available online on CKC website).

- (b) Fix policies and requirements applicable to non-resident judges.
- (c) Prescribe requirements for the testing of judges who are the subject of complaints.
- (d) Prescribe and communicate to judges, a Code of Ethics, of which any violations may subject the judge to the loss of any or all judging privileges.
- (e) Take such other action as the Board may deem necessary from time to time with a view to ensuring an adequate supply of competent judges.
- (f) Take generally such action, from time to time, to determine whether the judging privileges of a person should be continued, restricted or removed.

3.3 Contract Between a Club & a Judge

- 3.3.1 A verbal or written approach to a judge regarding a specific event must be confirmed in writing by the trial-giving club within 45 days of the inquiry or the assignment will be considered null and void and the judge is thereafter free to accept other assignments. In such circumstances, a judge who accepts another assignment must inform the trial-giving club by registered post.
- 3.3.2 After receipt of confirmation that the judge's services are required, a judge must confirm in writing within 45 days, acceptance of the assignment. If the club does not receive confirmation within 45 days, the agreement will be considered null and void and the club is free to seek the services of another judge. A letter to this effect must be mailed to the judge by registered post.
- 3.3.3 The Canadian Kennel Club will consider a signed letter by the club, for the engagement of a judge to officiate at future events, as a legal and authorized engagement. Any attempts to break such a contract by the club without reasonable and just cause could lead to immediate cancellation of future events until such dispute is settled. The Canadian Kennel Club will not enter into any disputes over fees and/or payments.

3.4 Substitute & Replacement Judge (28-09-11)

3.4.1 Substitute Judge (28-09-11)

- (28-09-11) (a) If an advertised judge is prevented from fulfilling an assignment in whole or in part on the day of the trial, a qualified substitute judge shall be selected by the Conformation Show and/or Obedience Trial Committee. If no licensed judge is available, any person in good standing with the CKC who has trained or exhibited a dog that has earned a C.D.X. title may be used as a substitute judge in an emergency.
- (28-09-11) (b) The awards and scores made by the advertised judge shall stand and the substitute shall judge only those remaining classes. No dog entered under the advertised judge shall be withheld from competition if it has already been passed by the advertised judge. Any dogs which have yet to appear in the ring may be withdrawn from competition if requested in writing by the handler, however, the entry fee will not be refunded.
- (28-09-11) (c) The substitute judge shall judge the classes as originally approved by the CKC. The trial secretary will notify the CKC in writing of the particulars of the substitute judge(s) officiating as soon as reasonably possible and in any event no later than when reporting the results of the trial.

3.4.2 Replacement Judge

- (28-09-11) (a) Where a trial-giving club is notified before or after the issuance of a judging schedule, but prior to the day of the trial, that an advertised judge will not, for whatever reason, be able to fulfill a judging assignment, attempts will be made to secure CKC approval for a replacement judge. If CKC approval cannot be obtained the club will then seek the approval of the local CKC Director or Obedience Trial Representative. The club will subsequently notify the CKC of the circumstances of the approval and of the changes made.
- (28-09-11) (b) All those who have entered dogs under the advertised judge shall be allowed to withdraw at any time prior to judging of that trial. All requests for withdrawal shall be in writing and all entry fees and listing fees will be returned to the owner or the authorized agent of the dog. When possible, the trial-giving club will attempt to notify exhibitors of the judging change at the time the judging schedule is sent out.

-
- 3.4.3 In all cases, changes in judges will be posted in a prominent location at ringside.
(28-09-11)
- 3.4.4 A qualifying score earned under a substitute or replacement judge will be considered as having been earned under the advertised judge.
(28-09-11)

3.5 Judges Entering or Handling Dogs

- 3.5.1 Obedience judges are allowed to exhibit dogs they own, co-own and dogs owned by other people at obedience trials.
- 3.5.2 A judge officiating at a trial may enter or handle any dog at that same venue on the days that they are not judging.
(29-09-11)
- 3.5.3 Immediate family members of obedience judges are allowed to exhibit at shows and trials at which the family member is officiating, but may not exhibit under the family member. In the case of a family member judging a tied score, an exhibiting family member must withdraw because of conflict and a notation will be made to this effect in the judge's book.
(29-09-11)

3.6 Indignities to a Judge

- 3.6.1 A judge officiating at a trial held under these rules shall not be subjected to indignities of any kind during the progress of the trial. It shall be the duty and obligation of the club holding the trial to see that this rule is effectively carried out.

3.7 Judge's Conduct

- 3.7.1 A judge must conduct himself in a manner that is fair and not prejudicial to the sport.

4 PREMIUM LIST, CATALOGUE & JUDGING SCHEDULE

4.1 Premium List

- 4.1.1 After permission to hold a trial has been granted and (30-09-11) the judging panel has been approved, a club must prepare a premium list
- 4.1.2 The premium list must contain the information as (30-09-11) prescribed by the CKC from time to time. See Appendix B – Premium List.
- 4.1.3 The trial-giving club shall forward one copy of the (30-09-11) premium list to each of the following: the CKC Head Office (Shows & Trials Division); the judges for the trial; the local CKC Board member; and the local Obedience Trial Representative. These are to be received not less than 60 days prior to the date of the trial.
- 4.1.4 When a specialty trial is held in conjunction with an (30-09-11) all-breed event, it is the responsibility of the specialty club to separate its premium list data from the all-breed premium list and distribute copies as required, making sure that the event is clearly identified.
- 4.1.5 Clubs are free to include other rules and regulations, as they deem necessary. However, if other rules are included, they become part of the premium list and will be enforced.
- 4.1.6 A club may choose to announce 2 judges for a given (30-09-11) class in its premium list. In such case the entries must be divided by lot, but no announcement of such drawing need be made to exhibitors/handlers in advance of the trial and no exhibitors shall be entitled to a refund of entry fee. A club may specify in its premium list that an exhibitor may designate on the entry form that his dog has previously received 2 qualifying scores or is not eligible to enter under one of the judges, in which case the trial-giving club must designate that the entry will be shown under the other judge. False information, however, shall be considered a misdemeanor and the exhibitor is liable to disciplinary action by the CKC

4.2 Catalogue

- 4.2.1 Each club holding an obedience trial must provide a standard catalogue, which shall contain such information as may be prescribed by the Board from time to time. See Appendix C – Catalogue.
(31-09-11)
- 4.2.2 No judge will be permitted to see the catalogue until after they have completed their judging assignment(s).
(31-09-11)
- 4.2.3 Every entry must be printed in the catalogue. If errors and omissions on the part of the club or printers occur, the trial giving club shall provide proof that the entry was taken before the closing date.
(31-09-11)
- 4.2.4 The name of the agent/handler must be included in the catalogue when this information is entered on the entry form.
(31-09-11)
- 4.2.5 A trial catalogue shall not be placed on sale or made available to exhibitors, officials, members of the show giving club or general public, until 1 and 1/2 hours prior to the opening of the first approved event. In the case of a club holding two (2) or more consecutive trials, the opening of the trial shall mean the day of the first trial.
(31-09-11)
- 4.2.6 In the event of an error in either the catalogue or judge's book which differs from the information on the entry form, the Trial Secretary or Chairperson may upon request from the owner/handler of said dog, correct the judge's book and marked catalogue to be sent to the CKC. The dog may compete in the class as stated on the entry form.
(31-09-11)
- 4.2.7 A trial-giving club shall provide a complimentary copy of its catalogue to each of the following: officiating judge(s), CKC Board member and to each CKC Obedience Representative representing the electoral zone in which the trial is being held if attending the trial.

4.3 Judging Schedule

- 4.3.1 A club holding an obedience trial (either independently or in conjunction with a conformation show) must prepare a judging schedule, after entries close. It will list the various classes and the number of dogs entered in each class. It will also indicate the start time of the first class.
- 4.3.2 Entries in each class may be arranged according to the size of the dog.
(33-09-11)

-
- 4.3.3 Confirmation of entry containing name and number of a dog, class entered, and name of exhibitor and a judging schedule must be sent to all exhibitors once entries have closed. A copy of the judging schedule must be sent to the CKC Head Office, each officiating judge, the CKC Director and CKC Obedience Representative representing the zone in which the trial is being held.
- 4.3.4 Any club which causes a judge to officiate for more than 7 hours (420 minutes), plus a meal period of not less than 30 minutes per day, shall be subject to an administrative fee as set by the Board, as well as an additional charge for each minute over the above time limit.
- 4.3.5 The formula for the preparation of the judging schedule shall be based on the judging of 9 Pre-Novice entries, 8 Novice entries, 8 Novice Intermediate entries, 7 Open entries and 6 Utility entries per hour which will be considered a reasonable average. Judges should not exceed those averages during the period of the show's and/or trial's duration.
- 4.3.6 The formula to calculate the time required to judge a class is: 60 min / # of dogs per hour for that class (see 4.3.5) x the # of entries in that class. (For example a Novice class with 9 entries shall be allotted 68 minutes). Trial secretaries shall prepare the judging schedule based on these numbers alone and must not take into consideration the possibility of absentees or any other influences.
- 4.3.7 An overload occurs when the time required for the judging of all classes judged by a particular judge exceeds 7 hours (420 minutes). If the club chooses not to limit its entries and upon closing of entries there is an overload, the club may then:
- (a) Pay the applicable administrative charge for the overload plus the additional charge per minute (provided the judge has consented to judge said overload)
 - (b) Appoint a different judge to judge the smallest entire class (by time) that will bring the entries within the limits. This must have CKC approval.
 - (c) If a single class is involved, the entry will be divided equally by the drawing of lots between the advertised judge and the additional judge. Immediately upon receiving CKC approval, the club must send the exhibitor of each entry so affected, a notification of the change of judge.
-

The exhibitor shall be permitted to withdraw such entries at any time prior to the day of the trial and the entry fees paid for entering such dogs shall be refunded. The club, in such notice to exhibitors, must also announce which of the 2 judges of a given class will judge the run-off of any tie scores which may finally develop between the 2 groups of dogs.

4.3.8 All obedience trials held under these rules must be completed no later than 11:00 p.m.
(33-09-11)

4.4 Limited Entries

4.4.1 If indications point to a probable entry in any or all classes in excess of the club's capabilities, it may limit entries in any or all classes by prominent announcement on the title cover page of its premium list or immediately under the obedience heading in the premium list of a combined conformation show and obedience trial that entries in such class, classes or trial, will close automatically when a certain limit has been reached, even if the official closing date for entries has not arrived.
(34-09-11)

4.4.2 When the advertised limit (if applicable) has been reached, all remaining entries may be assigned a position (by class) on the reserve list. The person making the entry shall be notified of his position on the list. In the event that the entry of a bitch in season is pulled after the closing date, it may be substituted with one from the reserve list up to and including the day of the trial. At the club's discretion, if the club is notified in writing after the closing date that an entry other than a bitch in season will be absent from a trial, the entry may be substituted with one from the reserve list up to twenty four hours prior to the trial. Fees will not be refunded for any reason other than a bitch being in season and to those on the reserve list who did not participate in the trial. Entry fees will be refunded within 10 days following the trial for those on the reserve list who did not participate in the trial.

5 RIBBONS & PRIZES

5.1 Ribbons & Rosettes

- 5.1.1 A club or association holding a trial under these rules shall provide ribbons and rosettes as provided in this section.
- 5.1.2 The following information shall appear on the face of each ribbon or rosette: name of the club or association holding the trial; the crest of the CKC; and the words “Qualifying Score”.
- 5.1.3 A ribbon shall only be provided for a dog that receives a qualifying score. It shall be royal blue in colour, not less than 5.08cm (2”) wide, and not less than 20.32 cm (8”) in length.
(35-09-11)
- 5.1.4 A rosette shall be provided for the highest scoring dog in each class. Each rosette shall bear the words “High In Class” and must identify the class. The colour shall be royal blue and white.
- 5.1.5 Rosettes may be offered for 2nd, 3rd, and 4th place. Each rosette must identify the class and the standing. The colour shall be royal blue and white.
- 5.1.6 A rosette and a CKC High In Trial certificate shall be provided for the highest scoring dog in an obedience trial. The rosette shall bear the words “High in Trial”. The colour shall be royal blue and white.
- 5.1.7 All ribbons or rosettes offered for Unofficial Classes, Parades, etc. shall be green. Only those dogs receiving qualifying scores will receive ribbons, trophies or prizes.
(35-09-11)
- 5.1.8 All other ribbons or rosettes offered may be any colour other than those specified in sections 5.1.3. through 5.1.7.
(35-09-11)
- 5.1.9 When a trial is held in conjunction with a conformation show, all rosettes will be of equal size to those being presented at the Conformation show.

5.2 Prizes & Trophies

- 5.2.1 All prizes and/or trophies being offered at an obedience trial must be listed in the premium list and catalogue. They must be offered to be won outright, and be awarded automatically on the basis of scores attained by dogs competing at the trial. Exceptions to

this include perpetual trophies, and those trophies or prizes that require 3 wins by the same exhibitor/handler (not necessarily with the same dog) for permanent possession which may be offered to the highest scoring qualifier.

- 5.2.2 Prizes and/or trophies will be awarded by the judge to (36-09-11) dogs with a qualifying score only.
- 5.2.3 A club which gives a split class may offer prizes and trophies on the basis of scores earned in each section.
- 5.2.4 Only prizes and/or trophies that are listed in the premium list may be awarded. (36-09-11)
-

6 ENTRIES & END OF TRIAL

6.1 Entry Requirements

- 6.1.1 Every dog entered in an approved obedience trial or sanctioned obedience match must be one of the following:
- (a) Registered with the CKC
 - (b) Have an Event Registration Number
 - (c) Have a Performance Event Number
 - (d) Eligible for registration with the CKC
 - (e) Have a Miscellaneous Certification Number (MCN) if it belongs to a CKC listed breed.
- 6.1.2 To be eligible to compete at approved obedience trials or sanctioned obedience matches a dog must meet the requirements of Section 6.1.1, and:
- (a) Must be at least 6 months of age.
 - (b) May be spayed, neutered, or debarked.
 - (c) May not be lame (it is the judge's responsibility to determine whether a dog is lame).
 - (d) May not compete if it has tape or bandages that may impair its working ability (such a dog must be immediately excused and under no circumstances may it be returned later for judging after the tape or bandages have been removed).
- 6.1.3 If a dog is not registered individually in the records of the CKC, it may be entered at a trial held under these rules as a "listed" dog, provided that:
-

-
- (a) If born in Canada, it is eligible for individual CKC registration.
 - (b) If not born in Canada it is eligible for individual registration in the records of the CKC.
 - (c) If it is a foreign born and owned dog, an Event Registration Number or CKC registration number is obtained from the CKC within 30 days of the first trial entered.
- 6.1.4 The entry of a listed dog at an obedience trial held under these rules (sanctioned obedience matches excluded), must be accompanied by the appropriate listing fees. All fees, listing and recording, must be remitted to the CKC by the club or association holding the trial, within the 21 days following the trial.
- 6.1.5 The CKC has the authority, at any time, to require the owner of a “listed” dog to submit proof of the dog’s eligibility for registration in the CKC stud book, and if the CKC is satisfied that the dog is not eligible for registration, it shall have the right to order the cancellation of all scores and prizes earned by the dog at trials held under these rules. Failing to comply with the CKC’s request to return ribbons and/or prizes to the clubs concerned automatically renders the owner of the dog ineligible to enter any dog in any competition approved by the CKC.
- 6.1.6 The CKC shall have the authority to advise a person entering a dog at an obedience trial that he may no longer include in the name of a dog any name which, in the opinion of the CKC, infringes on the rights of any person, partnership, or company whose kennel name has been registered by the CKC, or where such name is considered to be similar to a kennel name registered with any other national kennel club with whom the CKC has working arrangements with regard to mutual protection of registered kennel names. Where a person has been advised that he may no longer include a particular name in the name of a dog and the person continues to enter the dog at obedience trials with such name included, the CKC shall have the authority to cancel all awards, scores and prizes earned by the dog at obedience trials held after the original advice was communicated to the owner of the dog.
- 6.1.7 Subject to the provisions stated in these rules, no dog may be entered in any class for which it is not eligible at the time entries for the trial close. The entry of a dog that is improperly entered in a class for which it is not eligible cannot be altered to another class after entries close except as provided in section 6.9.7.
-

-
- 6.1.8 (37-09-11) No entry shall be made at any obedience trial of any dog which the judge, or any member of his immediate family owns, has owned (wholly or in part), sold, held under lease, or handled in the ring, within 6 months prior to the date of the trial. However, the above limitations shall not apply at sanctioned obedience matches or to substitute or replacement judges at official trials.
- 6.1.9 Every dog must be the bonafide property of the person listed as owner.
- 6.1.10 A dog may only be entered once in each class.
- 6.1.11 If the name of a dog which has earned a qualifying score at any obedience trial is subsequently changed, the old name must be given on the entry form at the next 2 obedience trials at which the dog is entered under its new name.
- 6.1.12 (37-09-11) The Obedience Trial Committee of any trial may decline any entry or remove any dog from its trial for just cause and no one shall have any claim or recourse against the organization holding the trial or any official connected therewith. Said officials must file their reasons for doing so with the CKC not less than 21 days after the trial has been held.
- 6.1.13 (37-09-11) All entries must be in the hands of the trial secretary by the official closing date and time. Clubs accepting any entries after the closing date shall be subject to an administrative fee as set by the Board.
- 6.1.14 When an obedience trial is held in conjunction with a conformation show, a dog can be entered in obedience classes only; however, in such cases, the entry form must state “for obedience trial competition only” followed by the class or classes entered. If, however, a dog is also entered for competition in the conformation show, the Conformation Show Rules must also be observed.

6.2 Entry Forms

- 6.2.1 The following information must appear on each entry form:
- (a) Registered name of dog
 - (b) CKC individual registration number (if registered in the CKC studbook), EventRegistration Number (ERN), Miscellaneous Certification Number (MCN) if it belongs to a listed breed, or Performance Event Number (PEN)

-
- (c) Name of breed
 - (d) Variety (if applicable)
 - (e) Sex of dog
 - (f) Date & place of birth
 - (g) Name of sire and dam
 - (h) Name of breeder(s)
 - (i) Class(es) entered
 - (38-09-11) (j) Required jump height if applicable
 - (k) Name and complete address of owner of the dog
 - (l) Signature and telephone number of the owner or authorized agent
 - (m) Name of handler if the dog is not to be handled by the owner or a member of the owner's immediate family.

6.2.2 (38-09-11) The dog must jump the height listed on the entry form. When a dog is entered in both Open and Utility in the same trial the same jump height must be used for both classes. A list of jump heights for each entry, as noted on entry form, must be compiled and provided to the table steward prior to the start of the trial.

6.2.3 A trial-giving club must reject an incomplete entry form, and promptly return it to whomever submitted it, be it the owner, lessee or authorized agent.

6.3 Entry Fees

6.3.1 A club may not accept an entry fee other than that which is published in the premium list or entry form or in any way discriminate between entrants.

6.3.2 The entry of a dog at a trial held under these rules must be accompanied by the entry fee.

6.3.3 Tendering of a dishonoured cheque or credit card in payment of entry fees shall be considered non-payment of entry fees, and is an offence punishable by disciplinary action and cancellation of awards.

6.3.4 Non-compliance with this section of these rules shall be considered an offence punishable by disciplinary action and cancellation of awards.

6.4 Dogs Must Compete

- 6.4.1 Any dog entered and received at an obedience trial must compete in all exercises of all classes in which it is entered, unless excused by the judge, official veterinarian, superintendent, or the Obedience Trial Committee chair. If excused by the official veterinarian, the excuse must be in writing on the form provided and attached to the judge's book. If the dog is excused by either the superintendent, judge, or Obedience Trial Committee chair, a note to this effect must be written on the inside cover of the judge's book and the reason stated thereon.

6.5 Bitches In Season

- 6.5.1 Bitches in season are not permitted to compete. The judge of an obedience trial must remove from competition any bitch in season, or any bitch which appears so attractive to males as to be a disturbing element.
- 6.5.2 When a bitch comes into season after entry of the bitch has been submitted to the trial secretary, a veterinarian's certificate, certifying that the bitch was in season within the 10 day period preceding the trial, must reach the trial secretary on or before the date of the trial. The trial-giving club must refund the entry fee, service charge and listing fee. The refund and the terms thereof must be clearly stated in the premium list.

6.6 Health

- 6.6.1 No dog may be entered at a trial held under these rules if the dog:
- (a) Is known to have distemper, parvovirus, kennel cough or other communicable disease, or
 - (b) Has recovered from infection with canine distemper or canine parvovirus within the last 14 days.
- 6.6.2 It is recommended that all dogs have a current immunization status.
- 6.6.3 Where it is found that these rules have been contravened, the dog in question shall be removed from the trial premises and the exhibitor/handler will be subject to disciplinary action.

6.7 Trial Venue & Precincts *(41-09-11)*

- 6.7.1 A club must define the precincts of the trial in the premium list. *(41-09-11)*
- 6.7.2 Only dogs entered in official classes, including Exhibition Only, are permitted within the precincts of the trial. *(41-09-11)*
- 6.7.3 There shall be no intensive or abusive training of dogs within the venue of the obedience trial. Violation of this rule may result in the removal of the dog from further competition at that obedience trial at that venue. *(41-09-11)*
- 6.7.4 No dog entered in the obedience trial will be allowed off leash unless it is in the ring being judged according to the obedience trial rules and regulations. *(41-09-11)*
- 6.7.5 Minor warming up of dogs is allowed before entering the ring. *(41-09-11)*
- 6.7.6 A dog that bites or attempts to bite another dog or a person outside the ring may be removed from the venue by the Obedience Trial Committee Chair. *(41-09-11)*
- 6.7.7 Where a person who has control or custody of a dog at a CKC event causes that dog to suffer serious injury or death through negligence or willful misconduct, the Obedience Trial Committee Chair shall file a report to the CKC for possible submission to the Discipline Committee. *(41-09-11)*
- 6.7.8 All persons must exercise care and control of any dog in their possession while attending an event. *(41-09-11)*

6.8 Class Eligibility

- 6.8.1 Where any of the obedience trial regulations require that a dog shall have won a particular obedience title before being entered in a specific class or test, eligibility to enter in that class shall be determined as follows: a dog may be entered in such a class in any obedience trial of which the final closing date occurs after the handler has been notified by at least 2 different judges that the dog has won 3 qualifying scores for the required title, even though the owner has not received official notification from the CKC that the dog has won the title. However, the owner must forfeit any prizes and qualifying scores won in that particular class, if the CKC does not subsequently notify the owner officially that the required title has been won.

-
- 6.8.2 Where any of the obedience trial regulations exclude
(42-09-11) from a particular class dogs which have won a particular obedience title, eligibility to enter that class shall be determined as follows: (with the exception of the Novice A & B classes as per section 10.5.3) a dog may continue to be exhibited in such a class after the handler has been notified by at least 2 judges that he has received 3 qualifying scores for such title. However, a dog may not be entered or exhibited in such class in any obedience trial of which the official closing date for the entries occurs after the owner has received official notification from the CKC that the dog has won the particular obedience title.
- 6.8.3 Once a dog has been entered in the Open class, it can
(42-09-11) no longer compete in the Novice A or B class. Once the dog enters the Utility A or B class, it can no longer compete in Open A. In the event that a dog is required to re-qualify, the requirements of this subsection shall not apply.

6.9 Moving Up

- 6.9.1 A dog that is registered in the records of the CKC or has a PEN, and ERN, or a MCN and has fulfilled the requirements for a title in accordance with these rules but at the time of the closing of entries for the trial has not received confirmation of the title may be moved to the next level of competition providing the request is submitted to the trial secretary on the appropriate move-up form by the owner or handler a minimum of one hour before the opening of the first trial on that day, schedule permitting.
- 6.9.2 When one or more trials are held on the same day in
(129-09-11) the same venue, the request for moving the dog up must be made a minimum of one hour prior to the scheduled start of the trial for which the dog is being moved up to, schedule permitting.
- 6.9.3 In the case of limited entry trial, move ups are per-
(129-09-11) mitted and the club is exempt from Section 4.3.4.
- 6.9.4 The Trial Secretary shall amend the judge's book and
(129-09-11) the marked catalogue, which is to be sent to the CKC with the requests attached to the appropriate entry forms.
- 6.9.5 If it is established by the CKC that a dog moved up to the next level has not completed the requirements for the lower level before moving up, then all qualifying ribbons and/or awards earned by the dog incorrectly entered shall be forfeited and cancelled by

the CKC and the owner may be subject to disciplinary action.

- 6.9.6 In order for a dog to be eligible to move up, the dog must be individually registered in the CKC or have a Performance Event Number (PEN), an Event Registration Number (ERN) or a Miscellaneous Certification Number (MCN) before entries close. The addition of a CKC number after close of entries does not make the dog eligible and will result in referral to the Discipline Committee.
- 6.9.7 Exhibitors incorrectly entered in the A class are permitted to move the dog to the corresponding B class up to one hour before the start of the trial.
(43-09-11)

6.10 End of the Trial

- 6.10.1 The club secretary or the trial secretary of the club holding an obedience trial held under these rules shall forward to the CKC all of the information contained in Appendix D – End of Trial, so as to be received not more than 21 days after the last day of the trial.
(44-09-11)
- 6.10.2 In the event that the CKC establishes that the required remittance fails to cover the prescribed fees and charges, an administrative fee as set by the Board will be payable by the trial giving club.
(44-09-11)
- 6.10.3 The CKC may require a trial-giving club to provide a report of any matter or matters connected with its trial. This must be made within 14 days of the date the club receive the request.
(44-09-11)
- 6.10.4 Non-compliance with the provisions of this section will result in an automatic administrative charge for each day over the 21 day period.
(44-09-11)

7 UNSPORTSMANLIKE CONDUCT

- 7.1 It shall be deemed unsportsmanlike conduct if a person during the running of or in connection with an event abuses or harasses a judge, trial official or any other person present in any capacity at the event.
- 7.2 Any handler who displays unsportsmanlike conduct or who is seen to kick, strike or otherwise roughly manhandle a dog at any time during the holding of

the event, may be expelled from the trial by the Obedience Trial Committee.

- 7.3 The judges shall also have the authority to expel a handler from a trial if they observe unsportsmanlike conduct on the part of the handler or see the handler kicking, striking or otherwise roughly manhandling a dog while the event is in progress. It will be the duty of the judge to report promptly to the Obedience Trial Committee the expulsion of a handler.
- 7.4 The Obedience Trial Committee shall investigate, at once, any instance of alleged unsportsmanlike conduct on the part of the handler, or any report that a handler has been observed kicking, striking or otherwise roughly manhandling a dog. If the Obedience Trial Committee, after investigation, determines that a handler is in violation of this section, and that the incident, if proven, would constitute conduct prejudicial to the sport or the CKC, it shall exercise its authority in accordance with the Complaints section of these rules.
- 7.5 The trial secretary shall submit to the CKC a complete report of any hearing action taken under this section within 21 days.

8 REGULATIONS FOR PERFORMANCE & JUDGING

8.1 Judging Standard

- 8.1.1 Standardized judging is of paramount importance. *(45-09-11)* Judges are not permitted to introduce their own variations into the exercises, but must see that each handler and dog executes the various exercises exactly as described within these rules and regulations. A handler who is familiar with these rules and regulations should be able to enter the ring under any judge without having to inquire how the particular judge wishes to have any exercise performed.
- 8.1.2 The judge will inform the first exhibitor in each class *(45-09-11)* what the heeling pattern will be ten minutes before that exhibitor enters the ring. This may be done verbally, by posting the pattern ringside or by demonstration.

-
- 8.1.3 Judges must adhere to the Obedience Trial Rules and Regulations, and must not qualify dogs that do not meet the minimum requirements.
(45-09-11)
- 8.1.4 It is the responsibility of the judge to make the tests interesting to the gallery and worthwhile to the handler. The judge must not permit judging to exceed the time limitations as specified in these rules so that the handlers and those watching do not become bored, and the competing dogs do not become tired.
- 8.1.5 The judge must remember that he is judging the dogs only on their ability to perform the tests set for them and not on their show points or conformation.
- 8.1.6 The judge must test each exhibitor/handler separately (except for the Sit and Down where groups of dogs are in the ring together).
- 8.1.7 A judge shall excuse from competition any dog or handler that interferes willfully with another competitor or competitor's dog and any dog which the judge considers unfit to compete.

8.2 Excusal, Disqualification & Reinstatement of a Dog

- 8.2.1 A dog that has been excused from the ring for any reason may not compete in any further exercises for that class.
(131-09-11)
- 8.2.2 A dog that bites or attempts to bite a judge, another person or dog in the ring shall be disqualified by the judge.
(131-09-11)
- 8.2.3 When a judge disqualifies or excuses a dog, the disqualification or excusal and the reason therefore must be recorded in the judge's book. The owner or handler of the dog must be advised of the reason before he leaves the ring.
- 8.2.4 A dog that has been disqualified may be reinstated as follows:
- (a) The owner of a dog, which has been disqualified at a trial held under these rules may, after 30 days from the date of disqualification, apply in writing to the CKC for reinstatement of the dog. A deposit, as set by the Board, must accompany the request for reinstatement.
 - (b) After the examination, the Examining Committee shall submit its report to the CKC who, in turn, will advise the owner of the results. If reinstated, half of the deposit will be returned to the owner. If not reinstated, the deposit is forfeited to the CKC.

-
- (c) Reinstatement of a dog following an examination as set forth in this section in no way affects the right of a judge to again disqualify the dog for the same or other reasons.

8.2.5 Any dog disqualified for biting or viciousness shall automatically be disqualified from entering in any other event in any other discipline until such time as the dog is officially reinstated.

8.3 Handlers with Disabilities

8.3.1 Handlers with disabilities may compete, provided (46-09-11) such handlers can move about the ring without physical assistance. The use of a wheelchair (power or manual), crutches, or cane is acceptable.

8.3.2 At the judge's discretion a modification to the exercise/ routine may be made to accommodate a handler with disabilities providing that such modification does not aid the dog's performance or inhibit other dogs and the dog is required to perform all exercises/ routine. (46-09-11)

8.3.3 The heeling exercises are expected to be performed at a brisk pace and there must be a definite change of pace during the slow and fast portion. Failure to do the above will result in a penalty, the same as for any other handler. Proper heel position must be determined prior to the commencement of the exercises and this position should be maintained throughout.

8.3.4 A handler who is blind may be assisted, if necessary, by the judge to get from one exercise to another. For the Figure Eight, the judge may permit the stewards to utter softly a verbal aid so that the handler may determine the position of the stewards. For exercises which require the judge to signal his orders to the handler, the judge may use a verbal order. After positioning a handler who is blind for a jumping exercise, the judge may permit the handler to leave the dog and walk up to the jump to feel it in order to determine its exact location. (46-09-11)

8.3.5 In the case of a handler with a hearing disability, a judge should take a position so that it will be conveniently possible for the handler to continuously observe the judge during the performance of the individual exercises. If the handler desires, the judge may use prearranged signals, in lieu of verbal commands to the handler, the handler may provide an interpreter who communicates the judge's commands or use an electronic aid to communicate. (46-09-11)

8.3.6 A handler who is prevented from throwing the dumbbell the required distance (in the Retrieve Exercises) by a physical disability may be permitted to line his dog up in the desired starting position, then on the judge's command of "Throw It," the handler may:

- (a) Give a "Stay" command, leave the dog, proceed away from the dog, throw the dumbbell and then return alongside the dog to continue the exercise
- (b) Throw the dumbbell with the aid of a device.

The same procedure may be followed for the Retrieve over the High Jump except that the handler may go up to, or go around the jump in order to throw the dumbbell the required distance.

8.3.7 In the Group Exercises extra assistance or space may be allowed depending upon the disability. However, the dogs must be in catalogue order.

8.4 Qualifying Performance

8.4.1 The orders for the exercises and the standards for judging are set forth in the following sections. The lists of faults are not intended to be complete but minimum penalties are specified for most of the more common and serious faults. A dog that makes none of the errors listed may still fail to qualify or may be scored non-qualifying for other reasons.

8.4.2 The judge shall carry a mental picture of the theoretically perfect performance in each exercise and shall score each dog against this visualized standard of perfection, which shall combine the utmost in willingness, enjoyment, and precision. Each fault or deviation from this standard must be penalized. There shall be no penalty of less than 1/2 point.

8.4.3 The judge must look for the following in testing each dog and score accordingly:

- (a) Enjoyment and willingness should be taken into consideration over a better worker that shows fear and a dislike of working.

-
- (47-09-11) (b) Talking to the dog by the handler, snapping of fingers, slapping of sides, and stamping of feet during the exercises will be penalized, even to the point of non-qualifying.
- (c) During the dog's heelwork, the handler should always walk briskly with the dog on the left side on a loose leash (guiding the dog by the leash is to be penalized).
- (d) Naturalness, gentleness and smoothness of handling are to be greatly desired.
- (e) The dog should never anticipate the handler's orders, but should wait for the commands or signals.
- (f) In all exercises where the dog must return to the handler, a dog that fails to come close enough so that the handler can touch it or recover the article without moving either foot must receive a non-qualifying score.

8.4.4 A judge shall not require any dog or handler to do anything, or penalize a dog or handler for failing to do anything, which is not required by these rules, such as requiring a dog to sit at the conclusion of Stand for Examination and Long Down.

8.4.5 A dog that fails to execute a principal designated feature of any exercise shall not be given a qualifying score in the exercise. A dog that anticipates the principal features of any exercise shall receive a non-qualifying score in that exercise.

8.4.6 A dog which, in the judge's opinion, would have failed to do a principal designated feature of an exercise had the handler not given additional commands or signals not permitted by the standard, shall be scored as though it had failed to do that particular exercise.

8.4.7 A qualifying score must never be awarded to a dog whose performance has not met the minimum requirements, that shows fear, resentment or aggression, relieves itself at any time in the obedience ring, leaves the ring during an exercise (except to complete a retrieve), or to a dog whose handler disciplines or abuses it in the ring. (See Chapter 7, Unsportsmanlike Conduct).

8.5 Judge's Orders & Signals

8.5.1 Before each or part of every exercise, a judge must ask the handler "Are You Ready?," and the exercise shall not start until acknowledged by the handler.

-
- 8.5.2 All orders or signals given to handlers shall be sufficiently clear and distinguishable for everyone to follow the judging and, at the end of each test, the judge shall say, "Exercise finished."
- 8.5.3 When giving orders (especially for heelwork), the judge must not stand at one end of the ring, but shall follow the handler at a discreet distance so that he may observe signals or undertones given by the handler to the dog.

8.6 Catalogue Order

- 8.6.1 Dogs must be judged in catalogue order to the extent that it is practical to do so without holding up the judging in any ring for a dog that is entered in more than one class at the show and/or trial.
- 8.6.2 Judges are not required to wait for dogs. It is the responsibility of each handler to be ready with his dog at ringside when required, without waiting to be called.
- 8.6.3 It is the handler's responsibility to notify the ring steward who notifies the judge if there is likely to be a conflict with the same dog being in the conformation or rally obedience ring. In the case of a conflict between an official obedience class and a rally obedience or unofficial obedience class, the official obedience class takes precedence.
- (48-09-11)*

8.7 Judge's Book

- 8.7.1 The judge shall not judge any dog until he has entered the scores of all dogs judged previously in the official judge's book, and until he has subtotaled such scores. Scores for the Long Sit and Long Down must be entered in the official judge's book immediately after each group of dogs has been judged. No scores may be changed except to correct a mathematical error. All totals must be entered in the judge's book before prizes are awarded. No person other than the judge may make an entry in the judge's book.
- 8.7.2 Following completion of the judging of each obedience class, the yellow copy of the judge's book, which sets forth the scores assigned by the officiating judge, must be posted in a prominent place, within the precincts of the trial.

-
- 8.7.3 Upon completion of the judging assignment, the judge must ensure that the cover of the judge's book is completed with start and finish times, signed and HIT recorded and awarded in the ring by the last judge completing the assignment for the trial.

8.8 Re-Judging

- 8.8.1 If a dog has failed in a particular part of an exercise, it shall not ordinarily be re-judged or given a second chance. If however, in the judge's opinion the dog's performance was prejudiced by peculiar or unusual conditions, the judge may, on a discretionary basis, re-judge the dog on the entire exercise.

8.9 Ties

- 8.9.1 In case of a tie, the dogs shall be re-tested again by having them perform individually, all or the same part of one or more of the regular exercises. In the case of a tie in Utility, the dogs shall be tested again by performing individually all or the same part of the signal exercise. The original scores shall not be changed.
- 8.9.2 In the case of a tie the judge shall inform the exhibitors involved and allow a reasonable warm up period.
(49-09-11)
- 8.9.3 In case of a tie for High in Trial, the dogs shall be tested by performing the Heel Free exercise individually.
- 8.9.4 The officiating judge of a trial must judge any run-off for High in Trial. In the event of two or more judges officiating at a single trial, the club shall designate in the premium list which judge will judge any run-off for HIT. Each Judge is responsible for breaking ties in the classes that they judge.
(49-09-11)

8.10 Scoresheets

- 8.10.1 At the conclusion of the judging of each class, judges are required to provide meaningfully marked individual scoresheets to each exhibitor.
(50-09-11)

8.11 Announcement of Scores

- 8.11.1 The judge shall not disclose any score or partial score
(51-09-11) to handlers or spectators until he has completed the judging of the entire class.
- 8.11.2 Immediately following the Pre-Novice, Novice and
(51-09-11) Open group exercises, the broad jump exercise in Novice Intermediate and the directed jump exercise in Utility, before the handlers leave the ring, the judge shall inform all handlers whether or not they have qualified.
- 8.11.3 After all the scores for the class are recorded, the
(51-09-11) judge shall call for all available dogs that have earned qualifying scores to be brought into the ring.
- 8.11.4 Before awarding the prizes, the judge shall inform the
(51-09-11) spectators as to the maximum number of points for a perfect score, and shall then announce the score of each prize winner, and announce to the handler the score of each dog that has earned a qualifying score.

8.12 Explanations & Errors

- 8.12.1 The judge is not required to explain scoring, and
should not enter into any discussion with any handler who appears to be dissatisfied. Any interested person who thinks that there may have been a mathematical error, or an error in identifying a dog, may report the facts to one of the ring stewards, the superintendent, or show or trial secretary so that the matter may be checked.

8.13 Ring Procedure

- 8.13.1 The judge shall not permit any handler to train any
dog or practice any exercise in the ring either before, during or after being judged.
- 8.13.2 Between exercises, imperfections in heeling will not
(52-09-11) be judged, but any disciplining by the handler in the ring, or any uncontrolled behaviour of the dog, such as snapping, unjustified barking, or running out of the ring, will be severely penalized by deducting points from the total score, and the judge may excuse the dog from further competition at that trial.
- 8.13.3 The judge shall attempt to standardize the heeling
(52-09-11) routine for all dogs in each class.

-
- 8.13.4 In all classes, dogs will enter the ring on a leash and proceed to the starting position of the first exercise.
- 8.13.5 In the Novice Class, the dog may be guided gently by the collar between exercises and may be guided by the collar into proper position for the next exercise.
- 8.13.6 In the Novice Intermediate, Open and Utility Classes, the dumbbell and articles shall be taken from the handler at the entrance to the ring, placed on the judges table until required, then returned before the handler leaves the ring.
(52-09-11)
- 8.13.7 In Utility, the handler shall carry the glove to the start of the seek back exercise.
- 8.13.8 In Novice Intermediate, Open and Utility, the dog shall not be put on leash or guided or controlled by the collar at any time from the beginning of the first exercise to the completion of the last exercise.
- 8.13.9 All dogs will be brought into and leave the ring on leash for all exercises.
(52-09-11)
- 8.13.10 Dogs shall not be picked up and carried in any obedience ring. The penalty imposed shall be a substantial deduction.
- 8.13.11 Any violation of the Obedience Trial Rules & Regulations committed by the handler will result in substantial or minor deductions or a non-qualifying score.
- 8.13.12 Physical guidance such as placing the dog in position with the hands or straightening the dog with the knees or feet is not permitted and shall be substantially penalized even if occurring before or between the exercises.
- 8.13.13 All exercises must be started with the dog sitting in the heel position.
- 8.13.14 In the Novice Intermediate, Open and Utility classes judges may, at their discretion verify the height of the dog at the withers as it is brought into the ring. The measurement is made using an ordinary folding ruler or steel tape that may be calibrated to show the correct jump height or an official measuring wicket if available. No other measuring device is required or acceptable in the ring. Measurements made by the judge are final and are not subject to verification.
(52-09-11)
- 8.13.15 No badges or clothing with club identification thereon, shall be worn or displayed by exhibitors/handlers when exhibiting in the ring.
(52-09-11)
-

8.14 Commands & Signals

- 8.14.1 In all parts of all exercises performed in the ring, only one single command or signal may be given by the handler. Any extra commands or signals, or the giving of a command and a signal must be penalized. Whenever the rules and regulations specify command and/or signal, the handler may give either one or the other, or both command and signal simultaneously. Where a signal is permitted and given, it must be a single gesture with either arm and hand only and the arm must be returned immediately to its original position.
(53-09-11)
- 8.14.2 When the dog is in heel position, the handler is permitted to bend body and knees so that the hand is brought to the dog's eye level when giving a signal.
(53-09-11)
- 8.14.3 Signals must be inaudible and the handler shall not touch the dog. Signaling correction to the dog from a distance is forbidden. Any unusual noises or motions may be considered to be signals.
- 8.14.4 The dog's name may be used once immediately before any verbal command, but may not be used when a signal is employed even though the standard specifies a command and/or signal. Whistling or the use of a whistle is prohibited. Any of these infractions must be penalized.
- 8.14.5 The dog's name alone may not be used as a command.
(53-09-11)
- 8.14.6 In all exercises where the dog is to return to the handler, while the dog is coming in and until the dog has sat in front, the handler must stand facing the dog with hands and arms hanging naturally at the sides. A substantial deduction shall be given for infractions of this rule.
(53-09-11)
- 8.14.7 In all exercises where the dog is required to heel free, one of the following options must be followed:
(53-09-11)
- (53-09-11)* (a) the handlers arms and hands must move naturally at the sides and must hang naturally at the sides when stopped.
 - (53-09-11)* (b) the right hand and arm must move naturally at the side, while the left hand must be held against the front of the body, centered in the area of the waist, with the left forearm held against the body.
-

-
- (53-09-11) (c) In either of the above situations, the hands and arms may be adjusted for balance during the fast pace.

8.15 Praise, Food & Petting

- 8.15.1 Moderate praise and petting is allowed between exercises, and parts of exercises, providing the dog is under control.
(54-09-11)
- 8.15.2 A dog whose handler takes food or other training aids into the ring at any time must be excused from that class.
(54-09-11)
- 8.15.3 No food, treats or training aids shall be allowed within 3.05m (10 feet) of the ring entrance.
(54-09-11)

8.16 Leash, Collar & Jacket (55-09-11)

- 8.16.1 The leash used in the Pre-Novice Classes shall be approximately 1.83m (6 feet) long and must be fabric or leather.
(55-09-11)
- 8.16.2 As each handler enters the ring, the judge shall see that the dog has on either a well-fitting plain buckle (metal or plastic) collar, martingale, slip or quick release collar. Slip collars of an appropriate single length of leather, fabric or chain with 2 rings, one on each end are acceptable. Martingale collars may be of chain, fabric, or leather; or of the half-check type, with fabric or leather around the neck, and chain in the joining loop. Fancy collars, special training collars, or collars that are either too tight or so large that they hang down unreasonably in front of the dog, are not permitted.
(55-09-11)
- 8.16.3 There shall not be anything hanging from the collar.
(55-09-11)
- 8.16.4 Collars other than those specified in these rules are not allowed within the venue. Violation of this may result in the removal of the dog from further competition at that obedience trial.
(55-09-11)
- 8.16.5 When conditions warrant and at the handler's discretion, a dog may wear a close fitting, plain sweater or jacket while competing in individual or group exercises.
(56-09-11)

8.17 Heel Position

- 8.17.1 Heel position, whether the dog is sitting, standing, lying down, or moving at heel, means that the dog's body shall be in a straight line facing the same direction as the handler. The dog's head to shoulder area should be in line with the handler's left hip and the dog should heel close to the handler but not to the point of touching.

8.18 Group Exercises

- 8.18.1 In the group exercises, a dog that leaves the place where it was left during the first portion of the group exercise must be excused prior to the second portion of the exercise.
(58-09-11)

8.19 Rings & Equipment

- 8.19.1 The superintendent and the officials of the club holding the obedience trial are responsible for providing rings and equipment which meet the requirements of these rules. However, the judge also must check the ring and equipment provided, and must report to the CKC after the trial any deficiencies that are not promptly corrected upon request.
- 8.19.2 If the trial takes place indoors, the ring should have a working area of at least 9.14m (30') wide and 12.19m (40') long. The ring must be thoroughly cleaned one hour before the judging starts if it has previously been used for breed judging. The floor shall have a surface or covering adequate to provide firm footing for the largest dogs, and rubber or similar non-slip material for the take-off and landing at all jumps.
- 8.19.3 At outdoor trials held in conjunction with a conformation show, a separate ring or rings (to be used for obedience only) shall be provided for the obedience classes. The ring size shall have a working area of at least 12.19m (40') wide and 15.24m (50') long. The ground shall be level and the grass, if any, shall be cut short.
- 8.19.4 Indoor and outdoor rings shall be enclosed with fencing or gates or rope or drapery approximately 60.9cm (2') high.

8.20 The High Jump

8.20.1 The side posts of the High Jump shall be 1.11m (4 feet) high and the jump shall be 1.52m(5 feet) wide between the posts, and shall be so constructed as to provide adjustment for each 2.54cm (1") increment, from 10.16cm (4") to 91.44cm (36"). The bottom board shall be 10.16cm (4") wide to give the minimum height required from the ground or mat surface, together with additional boards as follows:

- (a) One 2.54cm (1") board
- (b) One 5.08cm (2") board
- (c) One 10.16cm (4") board
- (d) One 15.25cm (6") board
- (e) Three 20.25 cm (8") boards

8.20.2 The jump shall be painted a flat white. The width in metric and inches shall be marked clearly on each side of each board in black, in 5.08cm (2") figures with the exception of the 2.54cm (1") board.

8.20.3 The judge and handler are responsible for making sure the dog jumps the correct height

8.20.4 Judges may, at their discretion, verify the height of any dog at the withers.

8.21 The Broad Jump

8.21.1 The Broad Jump shall consist of 5 separate hurdles, built to telescope for convenience; 3 hurdles 20.3cm (8") wide; 2 hurdles 10.2cm (4") wide, the largest measuring about 1.5m (5') in length and 15.2cm (6") in height at the highest point, all painted a flat white. The two 10.2cm (4") hurdles pushed together (to accommodate the small dogs) will represent the first 20.2 (8") hurdle in all distances jumped over 40.6cm (16").

8.21.2 The hurdles shall be used for the various jumps as follows:

- (60-09-11) (a) four 20.3cm (8") hurdles for jumps, 122cm - 183cm (48-72")
- (60-09-11) (b) three 20.3cm (8") hurdles for jumps, 71.1cm - 177cm (28-46")
- (60-09-11) (c) two 20.3cm (8") hurdles for jumps, 40.6cm - 71cm; (18-26")

-
- (60-09-11) (d) one 10.2cm (4") and one 20.3cm (8") hurdle for jump, 40.6cm (16")
- (e) two 10.2 cm (4") hurdles for jumps, 20.3cm - 35.6cm (8 - 14")

The highest hurdle shall be removed first when less than 4 hurdles are required.

- 8.21.3 The judge and handler are responsible for making
(60-09-11) sure the dog jumps the correct distance.

8.22 The Bar Jump

- 8.22.1 The Bar Jump shall consist of a bar between 5.08cm and 6.35cm (2 - 2 1/2") in diameter. It may be round or square with the 4 edges rounded sufficiently to remove any sharpness. The bar shall be marked in alternate sections of black and white of about 7.62cm (3") each. The bar shall be supported by 2, unconnected, 1.22m (4') upright posts 1.52m (5') apart. The bar shall be adjustable in 2.54cm (1") increments in height, from 10.16cm (4") to 91.44cm (36"), and the jump shall be so constructed and positioned that the bar can be knocked off without disturbing the uprights.

- 8.22.2 The judge and handler are responsible for making sure
(61-09-11) the dog jumps the correct height.

- 8.22.3 Judges may, at their discretion, verify the height of
(61-09-11) any dog at the withers.

9 PRE-NOVICE CLASS

9.1 Pre-Novice

- 9.1.1 The Pre-Novice Class is an elective class and earning the title is not a requirement to enter Novice Classes.

- 9.1.2 The Pre-Novice Class shall be for any dog of any recognized or listed breed which has not earned the title of P.C.D.
(98-09-11)

- 9.1.3 Dogs in this class may be handled by the owner or
(98-09-11) any other person.

- 9.1.4 A person may enter more than one dog in this class.
(98-09-11)

9.1.5 The same handler must handle each dog in all 5 exercises unless he has 2 or more dogs entered. In such cases, he must have an additional handler for each extra dog when they are judged together in the Group Exercise.
(98-09-11)

9.1.6 Only dogs that have not earned the title of C.D. may enter the Pre-Novice class.
(98-09-11)

9.2 Tests & Order of Judging & Scoring

9.2.1 The tests and order of judging shall be:
(99-09-11)

- (a) Heel on Leash
- (b) Figure 8
- (c) Sit for Examination
- (d) Recall
- (e) Long Sit

9.2.2 This class is scored qualify or non-qualify only. No numerical scores are awarded.
(99-09-11)

9.3 Pre-Novice Title (P.C.D.)

9.3.1 The CKC will permit the use of the letters P.C.D. , signifying Pre-Companion Dog to be used in connection with and after the name of each dog which has met the requirements for that title as hereinafter provided.

9.3.2 To be permitted to use the title of Pre-Companion Dog a dog must:
(100-09-11)

- (a) be registered with the CKC, or have an Event Registration Number (ERN), a Performance Event Number (PEN) or if listed in the miscellaneous list a Miscellaneous Certification Number (MCN).
- (100-09-11)* (b) earn a qualifying performance in each of the five (5) exercises at three (3) obedience trials held under these rules
- (100-09-11)* (c) earn three (3) qualifying performances under at least two (2) different judges.

9.3.3 When the foregoing requirements for the title Pre-Companion Dog are fully met, the owner (who must be recorded as owner in the records of the CKC) shall be entitled to a certificate issued by the CKC certifying that the title has been earned at approved trials held under CKC regulations.

9.4 Extra Commands or Signals

9.4.1 A dog, which in the judge's opinion, would have failed to do the principal designated feature of any exercise had the handler not given extra commands or signals that are not permitted shall receive a non-qualifying performance for that particular exercise. (101-09-11)

9.5 Heel on Leash

9.5.1 **The principal feature of this exercise is the ability of the dog and the handler to work as a team.** (102-09-11)

9.5.2 The orders for this exercise are: "Are you ready?," "Forward," "Halt," "Right turn," "Left turn," "About turn," "Slow," "Normal," "Fast," and "Exercise finished." They may be given in any sequence and may be repeated more than once. (102-09-11)

9.5.3 In the Pre-Novice Class, the handler shall enter the ring with his dog on a loose leash and stand still at the start position, with the dog sitting at heel position. On the judge's order, the handler may give a command or signal to heel, and start walking briskly with the dog on a loose leash. The dog shall walk close to the left side of the handler without forging, lagging or crowding, permitting the handler freedom of motion at all times. At each order to halt, the handler will stop and the dog should sit smartly at heel. The handler may give the dog a verbal command to sit. It is permissible after each halt, before moving again, for the handler to give the command or signal to heel. (102-09-11)

9.5.4 Handlers are permitted to give a maximum of two extra commands to heel provided, in the judge's opinion, the dog would have qualified without them. (102-09-11)

9.5.5 Handlers are permitted to give moderate verbal encouragement while heeling. (102-09-11)

9.5.6 When executing the slow and fast pace, handler and dog must significantly change pace from normal. (102-09-11)

9.5.7 When executing the about turn, the handler will do a right about turn in all cases. (102-09-11)

9.5.8 A non-qualifying performance shall be given to a dog which is unmanageable, or if the handler constantly controls the dog's performance by tugging on the leash, constantly adapts their pace to that of the dog, gives more than two additional commands or signals to heel or gives excessive verbal encouragement. (102-09-11)

9.6 Figure 8

9.6.1 **The principal feature of this exercise is the ability of the dog and the handler to work as a team.**
(103-09-11)

9.6.2 The orders for this exercise are: “This is the Figure 8 exercise. You may go in either direction. Are you ready?”, “Forward”, “Halt”, and “Exercise finished.”
(103-09-11)

9.6.3 In the Figure 8 exercise, the handler will stand with the dog sitting in heel position facing the judge, midway between the two stewards, who will stand about 3.66m (12') apart. The handler may go around either steward first. On the judge's order, the handler, with the dog on a loose leash shall go twice completely around the Figure 8 with one halt at the end of the exercise. The handler may give the dog a verbal command to sit.
(103-09-11)

9.6.4 Handlers are permitted to give a maximum of two extra commands to heel provided, in the judge's opinion, the dog would have qualified without them.
(103-09-11)

9.6.5 Handlers are permitted to give moderate verbal encouragement while heeling.
(103-09-11)

9.6.6 A non-qualifying performance shall be given to a dog which is unmanageable, or if the handler constantly controls the dog's performance by tugging on the leash, constantly adapts their pace to that of the dog, gives more than two additional commands or signals to heel or gives excessive verbal encouragement.
(103-09-11)

9.7 Sit For Examination

9.7.1 **The principal feature of this exercise is that the dog sit where left before and during the examination and show no shyness, resentment or aggression.**

9.7.2 The orders for this exercise are “Are you ready” “Sit your dog for examination and leave when ready,” “Back to your dog,” and “Exercise finished.”

9.7.3 On the judge's order, the handler will command or signal his dog to sit and, without further orders give the command and/or signal to stay, walk away in front of the dog to the end of a 1.83m (6') leash, turn and face the dog. The leash shall be held clear of the floor when the handler is in position.
(104-09-11)

-
- 9.7.4 The judge will approach the dog from the front and touch its head only. On the judge's order, the handler will return by walking around behind the dog to heel position.
(104-09-11)
- 9.7.5 The dog shall remain in a sitting position until the judge says "Exercise Finished".
(104-09-11)
- 9.7.6 The scoring of this exercise shall not start until the handler has given the command and/or signal to stay.
(104-09-11)
- 9.7.7 No additional commands are permitted during this exercise.
(104-09-11)
- 9.7.8 A non-qualifying performance shall be given to a dog which stands, lies down or moves away from the place where left either before or during the examination or displays shyness, resentment, or aggression at any time.
(104-09-11)

9.8 Recall

- 9.8.1 **The principal features of this exercise are that the dog stays where left, comes promptly to the handler when called and allows the handler to clip the leash onto the collar.**
- 9.8.2 The orders for this exercise are "Are you ready?," "Leave your dog," "Call your dog," "Put your leash on" and "Exercise finished."
(105-09-11)
- 9.8.3 In the recall exercise, the handler will remove the leash from the dog's collar and either hold it in one hand or place it around his neck.
(105-09-11)
- 9.8.4 On the judge's order, the handler will give the dog a command and/or signal to stay in the sitting position, leave the dog, walk about 6.1m (20'), turn and face the dog with his hands hanging naturally at his sides. On the judge's order, the handler will call or signal the dog which should come straight in at a brisk pace and sit in front of the handler. The handler may command the dog to sit. On the judge's order, the handler, without excessive bending or stretching or moving either foot, will clip the leash back on the dog. The dog should remain sitting until the judge says, "Exercise finished".
(105-09-11)
- 9.8.5 The handler may give the dog verbal encouragement once it has reached the half way point in the recall provided, if in the judge's opinion, the dog would have qualified without it.
(105-09-11)

9.8.6 A non-qualifying performance shall be given to any (105-09-11) dog which fails to stay where it is left until called, receives an additional command or signal to stay after the handler leaves, fails to come on the first command or signal or does not come close enough for the handler to clip the leash on without excessive stretching or bending or moving either foot.

9.9 Group Sit Exercise

9.9.1 **The principal feature of this exercise is for the dog to stay and remain in the sit position until the handler returns.**

9.9.2 The orders for this exercise are " Sit your dogs," "Leave your dogs," "Back to your dogs," "Exercise finished."

9.9.3 All dogs competing in a class will perform this exercise together. If, however, there are more than 8 dogs (139-09-11) competing they will be split into groups of not more than 8. Each group will be judged immediately following their individual exercises.

9.9.4 The dogs must enter the ring on leash and line up in (139-09-11) a straight line in catalogue order . Handlers' arm-bands shall be placed behind the dogs. The leash shall remain attached to the dog's collar and placed at the dog's right side.

9.9.5 On the judge's orders, the handlers shall sit their (139-09-11) dogs, give the command and/or signal to stay, immediately leave their dogs, walk about 6.1m (20'), turn and face their dogs.

9.9.6 The judging of this exercise will not start until the (139-09-11) judge orders the handlers to "Leave your dogs".

9.9.7 The judge shall take a position in the ring where both (139-09-11) the dogs and handlers can be observed. Thirty (30) seconds from the time the order to "Leave your dogs" was given, on the judge's order, the handlers must return promptly to their dogs, each walking around behind his own dog to the heel position. The dogs should not move from the sitting position until the judge says "Exercise finished".

9.9.8 No additional commands are permitted during this (139-09-11) exercise.

9.9.9 A non qualifying performance shall be given to any (139-09-11) dog which at any time during the exercise moves a substantial distance from the place it was left, goes to another dog, barks or whines unreasonably or fails to remain in the sit position until the handler has returned to heel position.

10 NOVICE CLASS

10.1 Novice A

- 10.1.1 The Novice A Class shall be for any dog of any recognized or listed breed which has not earned the title of C.D.
(63-09-11)
- 10.1.2 Only one dog per handler is allowed in this class, and that person must handle the dog in all exercises.
(63-09-11)
- 10.1.3 The handler of any dog in this class must be the owner, co-owner, or a member of their immediate families, and must be eligible to handle under section 10.1.4.
(63-09-11)
- 10.1.4 No person who has trained or exhibited a dog that has earned a C.D.X. title shall be allowed to handle a dog in this class.
(63-09-11)
- 10.1.5 When a dog is wrongfully entered in this class, any score awarded will be cancelled.

10.2 Novice B

- 10.2.1 The Novice B Class shall be for any dog of any recognized or listed breed which has not earned the title of C.D.
(63-09-11)
- 10.2.2 Dogs in this class may be handled by the owner or any other person.
(64-09-11)
- 10.2.3 A person may enter more than one dog in this class.
(64-09-11)
- 10.2.4 The same handler must handle each dog in all 6 exercises unless he has 2 or more dogs entered. In such cases, he must have an additional handler for each extra dog when they are judged together in the Group Exercises.
(64-09-11)
- 10.2.5 No dog may be entered in both the Novice A and Novice B Class at any one trial.
(64-09-11)

10.3 Novice C

- 10.3.1 The Novice C Class shall be for any dog of any recognized or listed breed that has earned the title C.D., C.D.X., U.D. or any Obedience Trial Championship Title prior to the closing date of the trial in which it is to be entered.
(65-09-11)

-
- 10.3.2 Dogs in this class may be handled by the owner or
(65-09-11) any other person.
- 10.3.3 A person may enter more than one dog in this class.
(65-09-11)
- 10.3.4 The same handler must handle each dog in all 6 exer-
(65-09-11) cises unless he has 2 or more dogs entered. In such cases, he must have an additional handler for each extra dog when they are judged together in the Group Exercises.
- 10.3.5 Dogs may compete in the Novice C class indefinitely.
(65-09-11)
- 10.3.6 Scores earned by dogs entered in the Novice C
(65-09-11) Class **are not eligible for High In Trial** and do not qualify a dog for any title.
- 10.3.7 Dogs may be entered the Novice C Class in addition
(65-09-11) to any other Official or Unofficial classes for which they are eligible.

10.4 Tests, Order of Judging & Scores

- 10.4.1 The tests, order of judging and scores for a perfect
(66-09-11) performance shall be:
- | | |
|------------------------------------|------------|
| (a) Heel on Leash and Figure Eight | 40 points |
| (b) Stand for Examination | 30 points |
| (c) Heel Free | 40 points |
| (d) Recall | 30 points |
| (e) Long Sit | 30 points |
| (f) Long Down | 30 points |
| Maximum Total Score | 200 points |

10.5 Companion Dog Title (C.D.)

- 10.5.1 The CKC will permit the use of the letters C.D., sig-
nifying Companion Dog, to be used in connection with and after the name of each dog that has met the requirements for that title as hereinafter provided.
- 10.5.2 To be permitted to use the title Companion Dog a
(67-09-11) dog must:
- (a) Be registered with the CKC, have an Event Registration Number (ERN), a Performance Event Number (PEN) or if listed in the miscellaneous list a Miscellaneous Certification Number (MCN).

(67-09-11) (b) Earn a qualifying score of more than 50% of the available points in each of the six (6) exercises and a total score of 170 or more points in the Novice Class at three (3) obedience trials held under these rules.

(67-09-11) (c) Earn three (3) qualifying scores under at least two (2) different judges in the Novice A and/or B Class

10.5.3 Once a dog has completed the requirements in 10.5.2, (137-09-11) it may continue to compete in the novice classes for 30 days or until it is awarded a high in trial.

10.5.4 When the foregoing requirements for the title Companion Dog are fully met, the owner (who must be recorded as owner in the records of the CKC) shall be entitled to a certificate issued by the CKC certifying that the title has been earned at approved trials held under CKC rules.

10.6 Heel On Leash & Figure 8

10.6.1 **The principal feature of this exercise is the ability of the dog and the handler to work as a team.**

10.6.2 The orders for this exercise are: "Forward," "Halt," (68-09-11) "Right turn," "Left turn," "About turn," "Slow," "Normal," "Fast," "Exercise finished." They may be given in any sequence and may be repeated more than once.

10.6.3 In the Novice Classes, the handler shall enter the ring (68-09-11) with the dog on a loose leash and stand still at the start position, with the dog sitting at heel position. On the judge's order, the handler may give the command or signal to heel, and will start walking briskly with the dog on a loose leash. The dog shall walk close to the handler's left side, without forging, lagging or crowding, permitting the handler freedom of motion at all times. At each order to halt, the handler will stop and the dog should sit smartly at heel without command or signal. It is permissible after each halt, before moving again, for the handler to give the command or signal to heel.

10.6.4 Any tightening or jerking of the leash or any act, signal, or command which, in the opinion of the judge, gives the dog unnecessary or unfair assistance shall be penalized, even to the point of non-qualifying.

10.6.5 When executing the slow and fast paces, the handler and dog must significantly change pace from normal.

-
- 10.6.6 The about turn will be executed by turning to the right in all cases.
(68-09-11)
- 10.6.7 After the completion of the heel portion of the exercise, the judge will order "Exercise finished" prior to the start of the Figure 8 exercise.
(68-09-11)
- 10.6.8 In the Figure 8 exercise, the handler will stand with the dog sitting in heel position facing the judge, midway between the two stewards, who will stand about 2.44m (8') apart. The handler may go around either steward first. On the judge's order, the handler with the dog on a loose leash shall go twice completely around the Figure 8 with at least one halt during and another at the end of the exercise.
(68-09-11)
- 10.6.9 A non-qualifying score shall be given to a dog which is unmanageable, or if the handler constantly controls the dog's performance by tugging on the leash, constantly adapts their pace to that of the dog or gives more than one additional command or signal to heel.
(68-09-11)
- 10.6.10 Substantial deductions shall be given for an additional command or signal to heel, for failure of the dog or handler to significantly change pace for fast or slow, failure to sit at a halt or failure to complete at least $\frac{3}{4}$ of the figure 8.
(68-09-11)
- 10.6.11 Substantial or minor deductions shall be given for poor sits, lagging, heeling wide, forging, crowding, occasional leash control, or failure of the handler to walk at a brisk normal pace, or any other imperfections in heeling.

10.7 Stand for Examination

- 10.7.1 **The principal feature of this exercise is that the dog stand where left before and during the examination and show no shyness, resentment or aggression.**
- 10.7.2 The orders for this exercise are "Stand your dog and leave when ready," "Back to your dog," and "Exercise finished."
(69-09-11)
- 10.7.3 On completion of the Figure Eight Exercise, the handler will remove the leash and give it to a steward, who will place it on the judge's table or other designated place.
(69-09-11)
- 10.7.4 On the judge's order the handler will stand and/or pose his dog. The method by which the dog is made to stand or pose is optional. The handler may take
(69-09-11)

any reasonable time in posing the dog, then without further order from the judge, will give the command and/or signal to stay, walk straight forward about 1.83m (6') turn and face the dog.

10.7.5 The judge will approach the dog from the front and touch the dog's head, withers and hindquarters only. On the judge's order, the handler will return by walking around behind the dog to heel position.

10.7.6 The dog shall remain in a standing position until the judge says "Exercise finished."

10.7.7 The scoring of this exercise will not start until the handler has given the command and/or signal to stay except for such things as rough treatment of the dog by its handler or active resistance by the dog to its handler's attempts to make it stand.

10.7.8 A non-qualifying score shall be given to a dog which sits, lies down or moves away from the place where left, either before or during the examination or displays shyness, resentment or aggression at any time.

10.7.9 Substantial or minor deductions, depending on the circumstances, shall be given for any handler who backs away from his dog, is not approximately 1.83m (6') from the dog during the examination, and for any dog that actively resists the handler's attempt to make it stand, moves its feet or sits or lies down after the examination but before the judge says "Exercise finished".

10.8 Heel Free

10.8.1 The orders and scoring for this exercise shall be the same as for the Heel on Leash. This exercise shall be done in the same manner as the Heel on Leash except that there shall be no Figure 8 and the dog is off leash. The leash shall be left on the judge's table for all work done in the Heel Free exercise.

10.9 Recall

10.9.1 **The principal feature of this exercise is that the dog stays where it is left and comes promptly to the handler when called.**

10.9.2 The orders for this exercise are "Leave your dog," "Call your dog," "Finish," and "Exercise finished."

10.9.3 On the judge's order, the handler will give the dog the command and/or signal to stay in the sitting position. (70-09-11) The handler will then walk about 12.19m (40'), turn to face the dog and stand with his arms and hands hanging naturally at his sides. On the judge's order or signal, the handler will call or signal the dog which should come straight in at a brisk pace and sit straight in front of the handler close enough so that he can readily touch the dog's head without excessive bending or stretching or moving either foot. On the judge's order, the handler will command or signal the dog which should go smartly to heel. The manner in which the dog finishes will be optional.

10.9.4 A non-qualifying score shall be given to any dog (70-09-11) which fails to stay where it is left until called, receives an additional command or signal to stay after the handler leaves, fails to come on the first command or signal, or does not come close enough for the handler to touch the dog's head without excessive bending, or stretching or moving either foot.

10.9.5 Substantial deductions shall be given for a second (70-09-11) command to stay before the handler leaves, for standing or lying down instead of waiting in the sit position, responding slowly to coming, failure to sit in front or finish, or for a handler giving an extra command or signal to sit or finish.

10.9.6 Substantial or minor deductions shall be given, (70-09-11) depending on the circumstances, for failing to come at a brisk pace, sitting out of easy reach, poor sit or finish, for interfering with the handler, or sitting between the handler's feet.

10.10 Group Sit & Down Exercises

10.10.1 **The principal features of these exercises are for (71-09-11) the dog to stay and to remain in the sit or down position, whichever is required by the particular exercise, until the handler has returned.**

10.10.2 The orders for these exercises are: "Sit your dogs" or "Down your dogs", "Leave your dogs," "Back to your dogs," "Exercise finished."

10.10.3 All dogs competing in a class will perform these exercises together. If, however, there are more than 8 dogs (71-09-11) competing they will be split into groups of not more than 8. Each group will be judged immediately following their individual exercises.

-
- 10.10.4 When the same judge judges the Novice A, B and/or (71-09-11) C classes, the classes may be combined provided the total number of dogs in the group does not exceed 8.
- 10.10.5 The dogs must enter the ring on leash and line up in (71-09-11) catalogue order along one side of the ring. Handlers' armbands, weighted with leashes, shall be placed behind the dogs.
- 10.10.6 On the judge's order, the handlers shall sit their dogs (71-09-11) and on further order the handlers shall give the command and/or signal to stay, immediately leave their dogs, walk to the opposite side of the ring and turn and face their dogs.
- 10.10.7 The judge shall take a position in the ring where both (71-09-11) the dogs and handlers can be observed. One (1) minute from the time the order to "Leave your dogs" was given, on the judge's order the handlers must return promptly to their dogs, each walking around behind his own dog to the heel position. The dogs should not move from the sitting position until the judge says "Exercise finished."
- 10.10.8 The Long Down is executed in the same manner as the (71-09-11) Long Sit except that instead of sitting the dogs, the handlers, on orders from the judge, shall down their dogs by command and/or signal. The time for this exercise shall be three (3) minutes. The dog should stay in the down position until after the judge says "Exercise finished."
- 10.10.9 The scoring of these exercises will not start until the (71-09-11) judge orders the handlers to sit or down their dogs.
- 10.10.10 A non-qualifying score shall be given to any dog (71-09-11) which at any time during the exercise moves a substantial distance from the place it was left, goes over to another dog, barks or whines unreasonably, or fails to remain in the sitting or down position (whichever is required by the particular exercise), until the handler has returned to the heel position.
- 10.10.11 A dog that leaves the place where it was left during (71-09-11) the first portion of the group exercise must be excused prior to the second portion of the exercise.
- 10.10.12 A substantial deduction shall be given for a handler (71-09-11) who repositions his dog after the dog is in the sit or down position or for a dog which sits, stands or lies down after the handler has returned to the heel position but before the judge has said "Exercise finished."
-

10.10.13 Substantial or minor deductions, depending on the
(71-09-11) circumstances, shall be given for a handler who touches the dog or its collar to get it into the sit or down position or for a dog which occasionally barks or whines or for a minor move from position.

11 NOVICE INTERMEDIATE CLASS

11.1 Novice Intermediate Class

11.1.1 The Novice Intermediate Class is an elective class
(107-09-11) and earning the title is not a requirement to enter the Open Classes.

11.1.2 Novice Intermediate Class shall be for any dog of any
(107-09-11) recognized or listed breed which has earned the title of Companion Dog, Companion Dog Excellent, Utility Dog or any Obedience Trial Championship.

11.1.3 Scores earned by dogs competing in this class **are**
(107-09-11) **not eligible for High in Trial.**

11.1.4 Dogs in this class may be handled by the owner or any
(107-09-11) other person.

11.1.5 A person may enter more than one dog in this class.
(107-09-11)

11.1.6 The same handler must handle each dog in all 6 exer-
(107-09-11) cises.

11.2 Tests, Order of Judging and Scores

(140-09-11) The tests, order of judging and scores for a perfect performance shall be:

- | | |
|---|-------------|
| (a) Heel Free and Figure 8 | (40 points) |
| (b) Stand for Examination | (30 points) |
| (c) Drop from Heel | (35 points) |
| (d) Recall holding dumbbell | (30 points) |
| (e) Recall over High Jump
holding dumbbell | (40 points) |
| (f) Recall Over Broad Jump | (25 points) |

11.3 Novice Intermediate Title (C.D.I.)

11.3.1 The CKC will permit the use of the letters C.D.I.,
signifying Companion Dog Intermediate, to be used

in connection with and after the name of each dog, which has met the requirements for that title as hereinafter provided.

11.3.2 To be permitted to use the title Companion Dog Intermediate a dog must:

- (a) be registered with the CKC, or have an Event Registration Number (ERN), or a Performance Event Number (PEN) or if listed in the miscellaneous list a Miscellaneous Certification Number (MCN).
- (109-09-11) (b) earn a qualifying score of more than 50% of the available points in each of the six (6) exercises and a total score of 170 or more points in the Novice Intermediate Class at three (3) obedience trials held under these regulations
- (109-09-11) (c) earn three (3) qualifying scores under at least two (2) different judges in the Novice Intermediate Class.

11.3.3 When the foregoing requirements for the title Companion Dog Intermediate are fully met, the owner (who must be recorded as owner in the records of the CKC) shall be entitled to a certificate issued by the CKC certifying that the title has been earned at approved trials held under CKC regulations.

11.4 Heel Free and the Figure 8

11.4.1 **The principal features are the same as in the** (111-09-11) **Novice Heel On Leash exercise.**

11.4.2 The orders and scoring for this exercise shall be the (111-09-11) same as for the Heel on leash and Figure 8 in Novice except that it is performed off leash.

11.4.3 All penalties listed under the Novice Heel On Leash (111-09-11) shall apply.

11.5 Stand for Examination

11.5.1 The principal features are the same as in the Novice (112-09-11) Stand for Examination exercise.

11.5.2 The orders and scoring for this exercise shall be the (112-09-11) same as for the Stand for Examination in Novice except the judge will approach from the front to examine the dog as in conformation, except that the judge shall not open the dog's mouth or touch the dog's testicles or tail.

11.5.3 All penalties listed under the Novice Stand for Examination shall apply.
(112-09-11)

11.6 Drop from Heel

11.6.1 **The principal features of this exercise are the heeling of the dog as described for the Heel Free Exercise, that the dog immediately respond to the handler's command and/or signal to drop, that the dog stays where left and comes promptly to the handler when called.**
(114-09-11)

11.6.2 The orders for this exercise are: "Forward," "Drop your dog," "Leave your dog," "Call your dog," "Finish," and "Exercise finished."

11.6.3 The handler will stand with his dog sitting in heel position at a point indicated by the judge. On the judge's order, the handler will command or signal the dog to heel and walk forward at a normal pace. After the handler has proceeded about 6.10m (20'), on the judge's order, the handler will command and/or signal the dog to drop. On further order from the judge, the handler will give the dog the command and/or signal to stay in the down position. The handler will then walk to the end of the ring, turn to face the dog and stand with his arms and hands hanging naturally at his sides. On the judge's order or signal, the handler will command or signal the dog to come and complete the exercise as in the Novice Recall Exercise.
(114-09-11)

11.6.4 A non-qualifying score shall be given to any dog which anticipates the drop, does not drop completely to the down position on a single command and/or signal, or for a dog that does not remain in the down position until called or signaled to come.
(114-09-11)

11.6.5 Substantial or minor deductions, depending on the circumstances, shall be made for a slow response to the handler's command and/or signal to drop or for delay or slowness in response to the recall.
(114-09-11)

11.6.6 All penalties listed under the Novice Recall and Heel Free Exercises shall also apply.
(114-09-11)

11.7 Recall Holding the Dumbbell

11.7.1 **The principal features of this exercise are that the dog takes the dumbbell, stays where left, and comes promptly to the handler with the dumbbell when called.**
(113-09-11)

11.7.2 The orders for this exercise are: “Give the dumbbell,”
(113-09-11) “Leave your dog,” “ Call your dog,” “Take it,” “Finish” and “Exercise finished.”

11.7.3 On the judge’s order, the handler, while standing with
(113-09-11) the dog sitting in heel position, holding the dumbbell directly in front of the dog, will command the dog to take the dumbbell. On further order from the judge, the handler will give the dog the command and/or signal to stay in the sitting position. The handler will then walk about 12.19m (40’), turn to face the dog and stand with his arms and hands hanging naturally at his sides. On the judge’s order or signal, the handler will call or signal the dog which should come straight in at a brisk pace and sit straight in front of the handler holding the dumbbell, without unnecessary mouthing or playing, close enough so that he can readily touch the dog’s head without excessive bending or stretching or moving either foot. On the judge’s order to take it, the handler will give a command and will take the dumbbell. The finish will be executed as in the novice recall.

11.7.4 A non-qualifying score shall be given to any dog
(113-09-11) which fails to take the dumbbell on the first command or signal, or fails to give up the dumbbell.

11.7.5 Substantial or minor deductions, depending on the
(113-09-11) circumstances, shall be made for mouthing, playing with or dropping the dumbbell or for the handler having to stretch forward to take the dumbbell.

11.7.6 All penalties listed under the Novice Recall shall also
(113-09-11) apply.

11.8 Recall Over High Jump Holding the Dumbbell

11.8.1 **The principal features of this exercise are that**
(113-09-11) **the dog takes the dumbbell, stays where left, jumps the high jump and comes promptly to the handler with the dumbbell when called.**

11.8.2 The orders for this exercise are: “Give the dumbbell,”
“Leave your dog,” “ Call your dog,” “Take it,” “Finish” and “Exercise finished.”

11.8.3 The Recall Over High Jump Holding the Dumbbell
(113-09-11) is executed in the same manner as the Recall Holding the Dumbbell except that the dog must jump the high jump. The handler must stand a minimum of 2.44m (8’) from the high jump and walk around the jump to a position in the center of and a distance of

at least 2.44m (8') beyond the jump and turn to face the dog and stand with his arms and hands hanging naturally at his sides. The high jump shall be as nearly as possible the height of the dog at the withers. (See Appendix "F" for a list of breed and age exceptions, and Appendix "G" for measurements.)

11.8.4 The judge and handler are responsible for making (115-09-11) sure the dog jumps the correct height.

11.8.5 A non-qualifying score shall be given to any dog (115-09-11) which fails to go over the high jump on the first command or signal, climbs the jump or uses the top of the jump as an aid in going over.

11.8.6 Substantial or minor deductions shall be given, (115-09-11) depending on the circumstances, for the dog touching the jump.

11.8.7 All penalties listed under the Novice Recall and (115-09-11) Novice Intermediate Recall Holding the Dumbbell shall also apply.

11.9 Recall Over Broad Jump

11.9.1 **The principal features of this exercise are that** (116-09-11) **the dog stays where left and jumps promptly on command or signal.**

11.9.2 The orders for this exercise are: "Leave your dog", (116-09-11) "Send your dog", "Finish" and "Exercise finished".

11.9.3 The handler will stand with the dog sitting in heel position at least 2.44m (8') from the jump. The jump shall be spaced so as to cover a distance equal to twice the height of the high jump, as set for the particular dog, with the low side of each hurdle and the lowest hurdle nearest the dog. (See Appendix "F" for a list of breed and age exceptions, and Appendix "G" for measurements.).

11.9.4 On the judge's order, the handler will give the dog the (116-09-11) command and/or signal to stay and walk around the jump to a position in the center of and a distance of at least 2.44m (8') beyond the jump and turn to face the dog and stand with his arms and hands hanging naturally at his sides. On the judge's order, the handler will give the command or signal to jump and the dog will clear the entire width of the broad jump without touching it and without further command or signal, return to a sitting position straight in front of the handler. The finish will be executed as in the Novice Recall.

11.9.5 A non-qualifying score shall be given to any dog which (116-09-11) fails to stay until commanded or signaled to jump, is given a second command to stay after the handler leaves, refuses to jump on the first command or signal, walks over any part of the jump, or fails to clear the full distance.

11.9.6 Substantial or minor deductions shall be given, (116-09-11) depending on the circumstances, for touching the jump.

11.9.7 All penalties listed under the Novice Recall shall also (116-09-11) apply.

12 OPEN CLASS

12.1 Open A

12.1.1 The Open A Class shall be for any dog of any recog- (72-09-11) nized or listed breed which has earned the title of C.D. but has not earned the title of C.D.X. .

12.1.2 The handler of any dog in this class must be the own- (72-09-11) er or a member of their immediate families.

12.1.3 Only one dog per handler is allowed in this class, and (72-09-11) that person must handle the dog in all exercises.

12.1.4 Any person who has trained or exhibited a dog that (72-09-11) has earned a U.D. title may not handle a dog in this class.

12.1.5 A dog which has earned its C.D.X. title is not eligible (72-09-11) for entry in this class but may be entered in the Open B Class.

12.1.6 When a dog is wrongfully entered in this class, any (72-09-11) score awarded will be cancelled.

12.2 Open B

12.2.1 The Open B Class shall be for any dog of any recog- (73-09-11) nized or listed breed which has earned the title of C.D.

12.2.2 Dogs which have earned the title of C.D.X. or U.D. (73-09-11) must enter in the Open B Class.

12.2.3 Dogs in this class may be handled by the owner or (73-09-11) any other person.

12.2.4 A person may enter or handle more than one dog in this class.
(73-09-11)

12.2.5 The same handler must handle each dog in all 7 exercises unless he has 2 or more dogs entered. In such case, he must have an additional handler for each extra dog when they are judged together in the Group Exercises.
(73-09-11)

12.2.6 No dog may be entered in both the Open A and Open B classes at any one trial.
(73-09-11)

12.2.7 A dog eligible for entry in the Utility Class at any obedience trial held under these rules is also eligible for entry in the Open Class B at the same trial.

12.2.8 Prior to the start of judging, the judge will decide the order of exercises to be performed. This order will not be disclosed to exhibitors until it is posted at ring side, approximately 30 minutes before the start of the class. In future assignments, judges are required to alternate the six orders of exercises so that each set will be used approximately the same number of times.
(73-09-11)

12.3 Tests, Order of Judging & Scores for Open A

12.3.1 The tests, order of judging, and scores for a perfect performance shall be:
(74-09-11)

(a) Heel Free and Figure Eight	40 points
(b) Drop on Recall	30 points
(c) Retrieve on Flat	25 points
(d) Retrieve over High Jump	35 points
(e) Broad Jump	20 points
(f) Long Sit	25 points
(g) Long Down	25 points
Maximum Total Score	200 points

12.4 Tests, Order of Judging & Scores for Open B

12.4.1 The tests, order of judging, and scoring for a perfect performance shall be:
(138-09-11)

OPEN 1

(a) Heel Free and Figure Eight	40 points
(b) Drop on Recall	30 points
(c) Retrieve on Flat	25 points
(d) Retrieve over High Jump	35 points

(e) Broad Jump	20 points
(f) Long Sit	25 points
(g) Long Down	25 points

OPEN 2

(a) Broad Jump	20 points
(b) Retrieve over High Jump	35 points
(c) Retrieve on Flat	25 points
(d) Drop on Recall	30 points
(e) Figure Eight and Heel Free	40 points
(f) Long Sit	25 points
(g) Long Down	25 points

OPEN 3

(a) Retrieve on Flat	25 points
(b) Drop on Recall	30 points
(c) Retrieve over High Jump	35 points
(d) Broad Jump	20 points
(e) Figure Eight and Heel Free	40 points
(f) Long Sit	25 points
(g) Long Down	25 points

OPEN 4

(a) Drop on Recall	30 points
(b) Heel Free and Figure Eight	40 points
(c) Retrieve over High Jump	35 points
(d) Broad Jump	20 points
(e) Retrieve on Flat	25 points
(f) Long Sit	25 points
(g) Long Down	25 points

OPEN 5

(a) Retrieve over High Jump	35 points
(b) Drop on Recall	30 points
(c) Figure Eight and Heel Free	40 points
(d) Retrieve on Flat	25 points
(e) Broad Jump	20 points
(f) Long Sit	25 points
(g) Long Down	25 points

OPEN 6

- | | |
|--------------------------------|-----------|
| (a) Broad Jump | 20 points |
| (b) Figure Eight and Heel Free | 40 points |
| (c) Drop on Recall | 30 points |
| (d) Retrieve over High Jump | 35 points |
| (e) Retrieve on Flat | 25 points |
| (f) Long Sit | 25 points |
| (g) Long Down | 25 points |

12.5 Companion Dog Excellent Title (C.D.X.)

12.5.1 The CKC will permit the use of the letters C.D.X., signifying Companion Dog Excellent, to be used in connection with and after the name of each dog that has met the requirements for that title as hereinafter provided.

12.5.2 To be permitted to use the title Companion Dog
(76-09-11) Excellent a dog must:

- (a) Be registered with the CKC, or have an Event Registration Number (ERN), or a Performance Event Number (PEN) or if listed in the miscellaneous list a Miscellaneous Certification Number (MCN).
- (76-09-11) (b) Earn a qualifying score of more than 50% of the available points in each of the seven (7) exercises and a total score of 170 or more points in the Open A or B Class at three (3) obedience trials held under these regulations.
- (76-09-11) (c) Earn three (3) qualifying scores under at least two (2) different judges in the Open A and/or B class.

12.5.3 When the foregoing requirements for the title of Companion Dog Excellent are fully met, the owner (who must be recorded as owner in the records of the CKC) shall be entitled to a certificate issued by the CKC certifying that the title has been earned at approved trials held under CKC regulations.

12.6 Heel Free & Figure 8 (77-09-11)

12.6.1 **The principal features are the same as in the Novice Heel On Leash exercise.**

12.6.2 The orders and scoring for this exercise shall be the
(77-09-11) same as for the Heel on leash and Figure 8 in Novice except that it is performed off leash.

12.6.3 All penalties listed under the Novice Heel On Leash (77-09-11) shall apply.

12.7 Drop On Recall (78-09-11)

12.7.1 The principal features of this exercise, in addition to those listed in the Novice Recall, are that the dog immediately respond to the handler's command or signal to drop, and remain in the down position until called or signaled to come.

12.7.2 The orders for this exercise are: "Leave your dog," "Call your dog," "Drop your dog," "Call your dog," "Finish," "Exercise finished."

12.7.3 On the judge's order, the handler will give his dog the command and/or signal to stay in the sitting position, leave the dog, and walk about 12.19m (40'), turn and face the dog. On order or signal from the judge, the handler will call or signal the dog which must come straight in at a brisk pace. While the dog is in motion, on the judge's signal, the handler will command or signal the dog to drop. Upon further order or signal from the judge, the handler will call or signal the dog to come. The dog will complete the exercise as in Novice Recall.

12.7.4 The dog will be judged on the promptness of its response to the command or signal to drop. (78-09-11)

12.7.5 A non-qualifying score shall be given any dog which anticipates the drop, does not drop completely to the down position on a single command or signal, or for a dog that drops but does not remain down until called or signaled to come. (78-09-11)

12.7.6 Substantial or minor deductions, depending on the circumstances shall be made for slow response to the handler's command or signal to drop, or for delay or slowness in response to either of the recalls. (78-09-11)

12.7.7 All penalties listed under the Novice Recall shall also apply.

12.8 Retrieve On Flat

12.8.1 **The principal features of this exercise are that the dog retrieves the dumbbell on command or signal and returns it to the handler.**

12.8.2 The orders for this exercise are "Throw it," "Send your dog," "Take it," "Finish," "Exercise finished."

12.8.3 The dumbbell shall have a single bar and be made of
(78-09-11) any rigid or hard material other than metal and must be approved by the judge. It may be painted or varnished but shall have no decorations or attachments. The size of the dumbbell shall be proportionate to the size of the dog.

12.8.4 On the judge's order, the handler will give a com-
(79-09-11) mand and/or signal to the dog to stay in the sitting position and throw the dumbbell at least 6.10m (20'). On the judge's order, the handler will give a command or signal to the dog to retrieve. The dog should go to retrieve the dumbbell at a brisk pace, return smartly and sit in front of the handler holding the dumbbell, without unnecessary mouthing or playing. On the judge's order to take it, the handler will give a command and will take the dumbbell. The finish will be executed as in the novice recall.

12.8.5 If the dumbbell is thrown unsatisfactorily, the judge
(79-09-11) may require a re-throw.

12.8.6 A non-qualifying score shall be given to any dog
(79-09-11) which fails to go out on the first command or signal, fails to retrieve, goes to retrieve before the command or signal is given, or fails to give up the dumbbell.

12.8.7 Substantial or minor deductions, depending on the
(79-09-11) circumstances, shall be made for slowness in going out or returning, slowness in picking up the dumbbell, mouthing or playing with the dumbbell, dropping the dumbbell, or reluctance to release the dumbbell to the handler.

12.8.8 All penalties listed under the Novice Recall shall also
(79-09-11) apply.

12.9 Retrieve Over High Jump

12.9.1 **The principal features of this exercise are that the dog, on command or signal, jump the high jump, retrieve the dumbbell and return over the jump to the handler.**

12.9.2 The orders for this exercise are "Throw it," "Send your dog," "Take it," "Finish," "Exercise finished."

12.9.3 The Retrieve Over High Jump is executed in the same
(80-09-11) manner as the Retrieve On Flat, except that the dog must jump the high jump. The handler must stand a

minimum of 2.44m (8') from the high jump and remain in the same position throughout the exercise. The dumbbell must be thrown a distance of at least 2.44m (8') beyond the jump. The high jump shall be as nearly as possible the height of the dog at the withers (See Appendix "F" for a list of breed and age exceptions, and Appendix "G" for measurements.).

12.9.4 The judge and handler are responsible for making sure the dog jumps the correct height.

12.9.5 A non-qualifying score shall be given any dog which (80-09-11) fails to go out over the high jump on the first command or signal, climbs the jump, uses the top of the jump as an aid in going over, or fails to return over the jump.

12.9.6 Substantial or minor deductions shall be given, (80-09-11) depending on the circumstances for touching the jump.

12.9.7 All penalties listed under the Retrieve on Flat shall (80-09-11) also apply.

12.10 Broad Jump

12.10.1 The principal features of this exercise are that the dog stay where left and jump promptly on command or signal.

12.10.2 The orders for this exercise are "Leave your dog," "Send your dog," "Finish," "Exercise finished."

12.10.3 The handler will stand with the dog sitting in heel (81-09-11) position at least 2.44m (8') from the jump. The jump shall be spaced so as to cover a distance equal to twice the height of the high jump, as set for the particular dog, with the low side of each hurdle and the lowest hurdle nearest the dog. (See Appendix "F" for a list of breed and age exceptions, and Appendix "G" for measurements.).

12.10.4 On the judge's order, the handler will give the dog the (81-09-11) command and/or signal to stay and walk to a position facing the right side of the jump about 61 cm (2') from the jump, and within the range of the first and last hurdle. On the judge's order, the handler will give the command or signal to jump and the dog should clear the entire width of the broad jump without touching it and, without further command or signal, return to a sitting position straight in front of the handler. The handler shall change position while the dog is in mid-air by executing a right turn. The finish will be executed as in the Novice Recall.

12.10.5 A non-qualifying score shall be given any dog which (81-09-11) fails to stay until commanded or signaled to jump, is given a second command to stay after the handler leaves, refuses to jump on the first command or signal, walks over any part of the jump, fails to clear the full distance.

12.10.6 Substantial or minor deductions shall be given, (81-09-11) depending on the circumstances, for the handler standing too close to the jump, not turning while the dog is in midair or for the dog touching the jump or a poor return.

12.10.7 All penalties listed under the Novice Recall shall also (81-09-11) apply.

12.11 Group Sit & Down Exercises

12.11.1 **The principal features and deductions are the same as for the Novice Group Sit & Down Exercises.**

12.11.2 The orders for these exercises are “Sit your dogs,” or “Down your dogs”, “Leave your dogs,” “Back to your dogs,” “Exercise finished.”

12.11.3 The Long Sit and Long Down exercises in the Open (82-09-11) Classes are performed in the same manner as in the Novice Classes, except that after leaving their dogs the handlers must immediately leave the ring and go to a place designated by the judge out of sight of their dogs, where they must remain until 3 minutes has passed. On the judge’s order the handlers will return to the ring and line up opposite their dogs and on further order, return to their dogs as in Novice.

13 UTILITY CLASS

13.1 Utility Class A

13.1.1 The Utility A Class shall be for any dog of any recognized or listed breed which has earned the title of (83-09-11) C.D.X. but has not earned the title of U.D.

13.1.2 Any person who has trained or exhibited a dog that (83-09-11) has earned a M.O.T.Ch title may not handle dogs in this class.

-
- 13.1.3 The handler of any dog in this class must be the owner or a member of their immediate families. (83-09-11)
- 13.1.4 Owners may enter more than one dog in this class. The same person must handle the dog in all exercises. (83-09-11)
- 13.1.5 When a dog is wrongfully entered in this class, any score awarded will be cancelled. (83-09-11)

13.2 Utility Class B

- 13.2.1 The Utility B Class shall be for any dog of any recognized or listed breed which has earned the title of C.D.X. or U.D. (84-09-11)
- 13.2.2 Dogs in this class may be handled by the owner or any other person. (84-09-11)
- 13.2.3 Owners may enter more than one dog in this class. The same person must handle the dog in all exercises. (84-09-11)
- 13.2.4 No dog may be entered in both the Utility A and Utility B classes at any one trial.
- 13.2.5 Prior to the start of judging, the judge will decide the order of exercises to be performed. This order will not be disclosed to exhibitors until it is posted at the ring side, approximately 30 minutes before the start of the class. In future assignments, judges are required to alternate the six orders of exercises so that each will be used approximately the same number of times. (84-09-11)

13.3 Tests, Order of Judging & Scores for Utility A

- 13.3.1 The tests, order of judging and scores for a perfect performance shall be: (85-09-11)
- | | |
|---|------------|
| (a) Seek Back | 30 points |
| (b) Scent Discrimination
Article No. 1 | 30 points |
| (c) Scent Discrimination
Article No. 2 | 30 points |
| (d) Signal Exercise | 40 points |
| (e) Moving Stand | 30 points |
| (f) Directed Jumping | 40 points |
| Maximum Total Score | 200 points |

13.4 Tests, Order of Judging & Scores for Utility B

13.4.1 The tests, order of judging and scores for a perfect performance shall be:
(86-09-11)

UTILITY 1

- | | |
|--|-----------|
| (a) Seek Back | 30 points |
| (b) Scent Discrimination
Article No.1 | 30 points |
| (c) Scent Discrimination
Article No.2 | 30 points |
| (d) Signal Exercise | 40 points |
| (e) Moving Stand | 30 points |
| (f) Directed Jumping | 40 points |

UTILITY 2

- | | |
|---|-----------|
| (a) Signal Exercise | 40 points |
| (b) Scent Discrimination
Article No. 1 | 30 points |
| (c) Scent Discrimination
Article No. 2 | 30 points |
| (d) Seek Back | 30 points |
| (e) Moving Stand | 30 points |
| (f) Directed Jumping | 40 points |

UTILITY 3

- | | |
|--|-----------|
| (a) Directed Jumping | 40 points |
| (b) Moving Stand | 30 points |
| (c) Seek Back | 30 points |
| (d) Scent Discrimination
Article No.1 | 30 points |
| (e) Scent Discrimination
Article No.2 | 30 points |
| (f) Signal Exercise | 40 points |

UTILITY 4

- | | |
|--|-----------|
| (a) Scent Discrimination
Article No.1 | 30 points |
| (b) Scent Discrimination
Article No.2 | 30 points |
| (c) Seek Back | 30 points |
| (d) Signal Exercise | 40 points |
| (e) Moving Stand | 30 points |
| (f) Directed Jumping | 40 points |

UTILITY 5

- | | |
|--|-----------|
| (a) Moving Stand | 30 points |
| (b) Directed Jumping | 40 points |
| (c) Signal Exercise | 40 points |
| (f) Seek Back | 30 points |
| (d) Scent Discrimination
Article No.1 | 30 points |
| (e) Scent Discrimination
Article No.2 | 30 points |

UTILITY 6

- | | |
|--|-----------|
| (a) Seek Back | 30 points |
| (b) Signal Exercise | 40 points |
| (c) Directed Jumping | 40 points |
| (d) Moving Stand | 30 points |
| (e) Scent Discrimination
Article No.1 | 30 points |
| (f) Scent Discrimination
Article No.2 | 30 points |

13.5 Utility Dog Title (U.D.)

13.5.1 The CKC will permit the use of the letters U.D., signifying Utility Dog, to be used in connection with and after the name of each dog which has met the requirements for that title as hereinafter provided.

13.5.2 To be permitted to use the title Utility Dog a dog
(87-09-11) must:

- (a) Be registered with the CKC, or have an Event Registration Number (ERN), or a Performance Event Number (PEN) or if listed in the miscellaneous list a Miscellaneous Certification Number (MCN).
- (87-09-11) (b) Earn a qualifying score of more than 50% of the available points in each of the six (6) exercises and a total score of 170 or more points in the Utility Class at three (3) obedience trials held under these regulations.
- (87-09-11) (c) Earn three (3) qualifying scores under at least two (2) different judges in the Utility A and/or B class.

13.5.3 *(88-09-11)* When the foregoing requirements for the title of Utility Dog are fully met, the owner (who must be recorded as owner in the records of the CKC) shall be entitled to a certificate issued by the CKC certifying that the title has been earned at approved trials held under CKC regulations.

13.6 Seek Back

13.6.1 **The principal features of this exercise are the heeling of the dog as described for the Heel Free Exercise and that the dog shall, on command, seek and retrieve the glove and return promptly with it to the handler.**

13.6.2 *(88-09-11)* The orders for this exercise are: "Forward," (followed by any other orders which the judge may give from the Heel Free routine), "Drop it," "Halt," "Send your dog," "Take it," "Finish," "Exercise finished." The judge must include at least one right or left turn in the heeling pattern. The glove will be dropped anywhere other than the center line of the send away.

13.6.3 *(88-09-11)* The glove must be plain, dark in color, and approved by the judge. It must be carried in the handler's right hand.

13.6.4 *(88-09-11)* The handler will stand with the dog sitting in the heel position and on the judge's order, will signal or command the dog to walk at heel. The handler and dog will execute the portions of the heel free exercise as the judge orders. On the judge's order to "Drop it", the handler will surreptitiously drop the glove while walking with the dog at heel. When the handler and the dog have proceeded at least 9.14m (30') after dropping of the glove, the judge will order the handler to turn and halt facing the end of the ring where the glove was dropped. Then on order from the judge, the handler will give the command or signal to seek and retrieve the glove.

13.6.5 *(88-09-11)* The handler must not point to the glove, but may point in the direction of the trail. He is to remain in the place from which the dog was sent. The dog may retrieve either by sight or scent and is expected to pick up the glove smartly and return briskly to the handler. The exercise is completed as in the Retrieve On Flat Exercise.

13.6.6 *(88-09-11)* A non-qualifying score shall be given any dog which fails to leave the handler on the first command, goes before commanded, does not continue to seek, does

not find and pick up the glove, does not return close enough for the handler to take it without moving either foot, or refuses to give up the glove.

13.6.7 Substantial or minor deductions, depending on the (88-09-11) circumstances, shall be given for imperfections in heeling, playing with the glove, going or returning slowly, failure to return directly, or reluctance to release the glove.

13.6.8 All penalties listed under the Heel Free and Retrieve (88-09-11) On Flat exercises shall also apply.

13.7 Scent Discrimination

13.7.1 **The principal features of this exercise are the dog's selection of the handler's articles from among the other articles by scent alone, and returning the article promptly to the handler.**

13.7.2 The orders for each of these exercises are "Take an (88-09-11) article," "Are you ready?" "Send your dog," "Take it," "Finish," and "Exercise finished."

13.7.3 The judge must ensure that the same two (2) mate- (88-09-11) rials from two of the three (3) article sets are used for each exhibitor. The materials to be used for each trail will be posted at ringside 30 minutes prior to the start of judging.

13.7.4 The Scent Discrimination exercise consists of 2 sep- (89-09-11) arate exercises in which the dog must select an article by scent. The articles shall be provided by the handler and shall consist of 3 sets of 5 identical articles. One set will be made of wood, one of metal, and one of leather. The articles may be items of everyday use. The size of the articles will be proportionate to the size of the dog. The metal articles will be of rigid metal. The articles in each set will be legibly numbered with a different number, and must be approved by the judge. The judge will select the two articles to be used. These 2 articles shall be placed conveniently within reach of the handler and shall not be handled by anyone else. The remaining 13 articles will be placed in full view, about 6.09m (20') in front of the handler and dog, about 15.24cm (6") apart and may be handled by the steward or judge.

13.7.5 After the articles are placed, the handler will turn his (89-09-11) back to the articles. On the judge's order, the handler will choose 1 of the 2 designated articles. The handler should confirm the number of the article with the

judge and one steward. The judge will make certain the handler scents each article with their hands only. The handler's hands must remain in plain sight at all times. When ready, the handler will put the article on the judge's book or clipboard. The judge will ask "Are you ready?" then place the scented article among the other articles.

13.7.6 Taking the article from the handler will be considered the first order, and scoring of the exercise will begin at that time.
(89-09-11)

13.7.7 On the judge's order, the handler may send the dog either directly or from heel position.

(a) If sending the dog directly, the handler may give the dog his scent by placing the palm of one hand in front of the dog's nose and returning it to the original position then give the command or signal to retrieve before executing the right about turn towards the articles.

(b) If sending from heel position, the handler will give the dog the command or signal to heel, execute a right about turn, then stop, facing the articles. The dog should execute the turn with the handler and sit at heel. The handler may give the dog his scent by placing the palm of one hand in front of the dog's nose and returning it to the original position before giving the command or signal to retrieve.

The method by which the handler sends the dog must be the same for both articles.

13.7.8 The dog shall go briskly to the articles, but may take a reasonable time to select the correct article provided the dog works continuously. After finding and picking up the correct article, the dog should bring it briskly to the handler. The exercise is completed as in the Retrieve on Flat exercise.
(89-09-11)

13.7.9 The same procedure shall be followed in each of the two (2) Scent Discrimination Exercises. Should an incorrect article be retrieved in either exercise, the incorrect article shall be placed on the judge's table or chair and the judge must remove the handler's scented article from the remaining articles. After the completion of the exercise, the articles shall be picked up and removed.
(89-09-11)

13.7.10 A non-qualifying score shall be given any dog which fails to go to the articles on the first command or signal, fails to retrieve the correct article, goes to the articles before the command or signal is given, fails to
(89-09-11)

return close enough for the handler to take it without moving either foot, fails to give up the article or if the handler changes his method of sending the dog.

13.7.11 Substantial deductions shall be given for a dog that is excessively slow going or returning, or which picks up an incorrect article, even if the dog puts it down immediately.
(89-09-11)

13.7.12 Substantial or minor deductions, depending on the circumstances, shall be given to a dog which does not work continuously or plays excessively with or mouths the articles.
(89-09-11)

13.7.13 All penalties listed under the Retrieve On Flat Exercise shall also apply.
(89-09-11)

13.8 Signal Exercise

13.8.1 **The principal features of this exercise are the heeling of the dog as described for the Heel Free Exercises, and the dog's ability to respond correctly to the handler's signals.**

13.8.2 The orders for this exercise are the same as in the Novice Heel Free exercise as well as "Stand your dog" and "Leave your dog". In addition the judge will signal the handler to drop, sit, come and "finish" the dog in that order.
(90-09-11)

13.8.3 In the Signal Exercise the heeling is done in the same manner as the Novice Heel Free Exercise except that throughout the entire exercise the handler uses signals only and should not speak to the dog at any time.
(90-09-11)

13.8.4 Following a heeling pattern executed as in the Novice Heel Free Exercise, on the judge's order, while heeling at a normal pace, the handler shall signal the dog to stand in the heel position near one end of the ring. On further order, the handler shall signal the dog to stay, then walk to the far end of the ring, turn and face the dog. On specific signals from the judge, the handler shall signal the dog to drop, sit, come and finish.
(90-09-11)

13.8.5 Each signal must be given smartly with one single gesture, using either arm and hand only. The arm must be returned immediately to its original position.
(90-09-11)

13.8.6 A non-qualifying score shall be given to any dog which fails to stand, remain standing where left, drop, sit, come close to the handler on a single signal or to a handler that gives an audible command to the dog to do any part of these exercises.
(90-09-11)

-
- 13.8.7 Substantial deductions shall be given for any audible
(90-09-11) command given during the heeling part of the exercise or for the finish.
- 13.8.8 Substantial or minor deductions, depending on the
(90-09-11) circumstances, shall be given for a dog that makes minor moves during the stand, drop, and/or sit portion of the exercise.
- 13.8.9 All penalties listed under the Novice Heel and Recall
(90-09-11) Exercises shall also apply.

13.9 Moving Stand & Examination

- 13.9.1 **The principal features of this exercise are that the dog heel, stand and stay as the handler moves away, accept the examination without shyness, resentment or aggression and return to the handler on command.**
- 13.9.2 The orders for this exercise are: “Forward,”
(90-09-11) “Stand,” “Call your dog,” “Finish” and “Exercise finished”.
- 13.9.3 The handler will stand with his dog sitting in heel
(90-09-11) position at a point indicated by the judge. On the judge’s order the handler will command or signal the dog to heel and walk forward at a normal pace. After the handler has proceeded about 3.05m (10’), on the judge’s order, the handler will command without pausing and/or signal the dog to stand and continue forward about 3.05m - 3.66m (10’-12’), then turn around and stand facing the dog. The dog must stand and stay in position. The judge will approach from the front to examine the dog as in conformation, except that the judge shall not open the dog’s mouth or touch the dog’s testicles or tail. On the judge’s order or signal, the handler will command or signal the dog to come and complete the exercise as in the Novice Recall Exercise.
- 13.9.4 A non-qualifying score will be given to any dog that
(91-09-11) displays fear, resentment, or aggression, moves from the place where it was left, sits or lies down before it is called, repeatedly whines or barks, stands before commanded or fails to heel, stand, stay or to accept the judge’s examination or returns to the handler.
- 13.9.5 Substantial or minor deductions, depending on the
(91-09-11) circumstances, shall be given to a handler that hesitates or pauses while giving the stand command and/or signal, or a dog which moves its feet while remaining in place.

13.9.6 All penalties listed under the Novice Heel Free, (91-09-11) Stand for Examination and Recall Exercises shall also apply.

13.10 Directed Jumping

13.10.1 **The principal features of this exercise are that the dog shall go away from the handler in the direction indicated, stop when commanded, and jump as directed.**

13.10.2 The orders for this exercise are: “Send your dog”, (92-09-11) “High jump,” “Bar jump,” “Finish” and “Exercise finished”.

13.10.3 The handler will stand with the dog sitting in heel (92-09-11) position on the center line of the ring about 6.09m (20') from the line of the jumps. The jumps shall be placed midway in the ring at right angles to the sides of the ring, not less than 4.27m (14') apart. The bar jump is to be placed on one side and the high jump on the other side. Jump heights are to be set as in the Retrieve Over High Jump exercise.

13.10.4 In the first half of this exercise, on the judge's order, (92-09-11) the handler will command and/or signal the dog to go forward at a brisk pace between the jumps to the other end of the ring to an equal distance beyond the jumps and in the approximate center, at which point the handler will command the dog to sit. The dog should stop, turn to face the handler and sit. The dog need not sit squarely at this point.

13.10.5 The judge will then designate which jump (bar jump (92-09-11) or high jump) is to be jumped first; whereupon, the handler will command and/or signal the dog to return over the designated jump. The order of the jumps shall be the same for all dogs. The jump shall be jumped clear. The signal must be a single gesture with one arm and hand only, and the arm must be immediately returned to its original position. While the dog is in midair, the handler may turn to face the dog as it lands. The dog shall sit in front of the handler and finish as in the Recall Exercise.

13.10.6 The same procedure will be followed for the second (92-09-11) half of the exercise except the opposite jump will be taken. It is the judge's option to designate which jump is to be taken first but both jumps must be taken to complete the exercise.

-
- 13.10.7 A non-qualifying score shall be given to a dog that does not leave the handler on the first command and/or signal, leaves before the command and/or signal is given, does not go out between the jumps, stops before commanded, does not stop on command at least 3.05m (10') beyond the jumps, does not jump as directed on the first command in either half of the exercise, takes a jump before commanded, climbs the jump, or knocks off the bar or to a handler that gives a second command to sit while the dog is still in motion.
(92-09-11)
- 13.10.8 Substantial deductions shall be given to any dog which does not sit on command or to a handler who gives a second command to sit after the dog has stopped.
(92-09-11)
- 13.10.9 Substantial or minor deductions, depending on the circumstances, shall be given to any dog which does not stop in the approximate center of the ring about 6.09m (20') beyond the line of the jumps, is slow in going or returning, touches the jumps or to a handler that turns to face the dog before it has jumped or after it has landed.
- 13.10.10 All penalties listed under the Recall Exercises shall also apply.
(92-09-11)
-

14 OBEDIENCE TRIAL CHAMPIONSHIPS

14.1 Obedience Trial Champion

- 14.1.1 Any dog having attained the 3 obedience trial titles of C.D., C.D.X. and U.D. shall be recognized as an Obedience Trial Champion, and shall be entitled to bear the prefix O.T.Ch. before its name.
(94-09-11)

14.2 Obedience Trial Champion Excellent

- 14.2.1 The CKC will permit the use of the letters O.T.Ch.X. to be used as a prefix of the name of any dog which has met the requirements for that title as hereinafter provided.
(95-09-11)
- 14.2.2 This title may only be earned after the completion of the O.T.Ch. title.
(95-09-11)
-

14.2.3 The dog must qualify in both the Open B and Utility B Classes in the same trial on 5 different occasions.
(95-09-11)

14.3 Master Obedience Trial Champion

14.3.1 The CKC will permit the use of the letters M.O.T.Ch. to be used as a prefix of the name of any dog which has met the requirements for that title as hereinafter provided
(96-09-11)

14.3.2 Points for this title may only be accumulated after the completion of the O.T.Ch. title.
(96-09-11)

14.3.3 Points may be accumulated simultaneously with credits toward both the O.T.Ch.X. and M.O.T.Ch. titles. However, the M.O.T.Ch. title will not be awarded until completion of the O.T.Ch.X. title.
(96-09-11)

14.3.4 One High In Class placement is required in either the Open B or Utility B Class but no minimum score is required.
(96-09-11)

14.3.5 A dog must acquire a total of 40 points to earn a M.O.T.Ch. title. A minimum of 15 points must be obtained from both the Open B and Utility B classes. The remaining 10 points can be obtained from either class.
(96-09-11)

SCALE OF POINTS

Open		Utility	
190 to 191.5	1 point	185 to 187.5	1 point
192 to 193.5	2 points	188 to 190.5	2 points
194 to 195.5	3 points	191 to 193.5	3 points
196 to 197.5	4 points	194 to 195.5	4 points
198 to 199.5	5 points	196 to 198.5	5 points
200	6 points	199 to 200	6 points

14.4 Grand Master Obedience Trial Champion

14.4.1 The CKC will permit the use of the letters G.M.O.T.Ch. to be used as a prefix of the name of any dog which has met the requirements for that title as hereinafter provided.
(97-09-11)

14.4.2 Requirements for this title may only be accumulated after the completion of the Master Obedience Trial Champion Title.
(97-09-11)

14.4.3 The requirements are:

(97-09-11)

- (a) a minimum score of 195 points in both the Open B and Utility B classes at the same trial at ten (10) separate trials.
- (b) pairs must be earned under a minimum of ten (10) different judges. Pairs may be counted under two (2) different judges, provided it's the same trial.
- (c) a high in trial with a score of 195 or higher out of the Open B class.
- (d) a high in trial with a score of 195 or higher out of the Utility B class.

14.4.4 The High In Trial do not need to be earned as part of a pair.

(97-09-11)

15 EXHIBITION ONLY CLASS

15.1 Exhibition Only

15.1.1 This is an official class. A dog may be entered for Exhibition Only, which must be specified, on the entry form. All dogs entered in this class shall be listed in the catalogue with the same particulars as for a dog entered for competition. No dog so entered can compete in any Regular class, however, it may be entered in and compete in any Unofficial class or Parade if provided for in the classification of the trial, and on payment of the prescribed fees. If applicable, the listing fee is payable. A listing fee is not required for a listed dog entered in Exhibition Only (not entered for any competition).

16 UNOFFICIAL CLASSES

16.1 Unofficial Classes

16.1.1 Unofficial obedience classes may be offered at the option of the trial-giving club and may be held by any club holding an approved obedience trial, providing all the official classes are offered. All dogs entered in the Unofficial Classes must be entered in one of the Official Classes or Exhibition Only.

16.1.2 All Unofficial Classes may be judged by a CKC approved obedience judge, an applicant or apprentice judge, or by a person who has attained at least an O.T.Ch.

16.1.3 All ribbons and rosettes shall be green. Only dogs (117-09-11) receiving a qualifying score will receive ribbons, trophies or prizes as per section 5.1.7.

16.1.4 The following sections list the recognized unofficial obedience classes.

16.2 Graduate Novice Class

16.2.1 The Graduate Novice Class is open to any dog that (118-09-11) has not earned a qualifying score toward the C.D.X. title, but has obtained the title of C.D prior to the closing date of the trial in which it is to be entered.

16.2.2 The owner or any other person may handle dogs in (118-09-11) this class.

16.2.3 A person may enter more than one dog in this class. (118-09-11)

16.2.4 The same handler must handle each dog in all 6 exercises (118-09-11) unless he has 2 or more dogs entered. In such cases, he must have an additional handler for each extra dog when they are judged together in the Group Exercises.

16.2.5 The Graduate Novice exercises will be performed (118-09-11) and judged as in the official Novice Class, except that the Heel Free and Figure 8, Drop on Recall, Long Sit and Long Down Exercises will be performed and judged as in the official Open Class.

16.2.6 The tests, order of judging and scores for a perfect (118-09-11) performance shall be:

(a) Heel on Leash (No Figure 8)	40 points
(b) Stand for Examination	30 points
(c) Heel Free and Figure 8	40 points
(d) Drop on Recall	30 points
(e) Long Sit	30 points
(f) Long Down	30 points
Maximum Total Score	200 points

16.3 Graduate Open Class

16.3.1 *(119-09-11)* The Graduate Open Class is open to any dog that has not earned a qualifying score toward the U.D. title, but which has obtained the title of C.D.X. prior to the closing date of the trial in which it is to be entered.

16.3.2 *(119-09-11)* The owner or any other person may handle dogs in this class.

16.3.3 *(119-09-11)* A person may enter more than one dog in this class.

16.3.4 *(119-09-11)* The same handler must handle each dog in all 6 exercises unless he has 2 or more dogs entered. In such case, he must have an additional handler for each extra dog when they are judged together in the Group Exercises.:

(a) Heel Free and Figure 8	40 points
(b) Stand for Examination	30 points
(c) Drop on Recall	30 points
(d) Select and Retrieve Wooden Article	30 points
(e) Directed Jumping	40 points
Maximum Sub-Total	170 points
(f) Long Sit (3 min. with handler out of sight)	30 points
Maximum Points	200 points

16.3.5 *(119-09-11)* The tests, order of judging and scores for a perfect performance shall be:

(a) Heel Free and Figure 8	40 points
(b) Stand for Examination	30 points
(c) Drop on Recall	30 points
(d) Select and Retrieve	30 points
(e) Directed Jumping	40 points
(f) Long Sit	30 points
Maximum Total Score	200 points

16.3.6 Heel Free and Figure 8

(119-09-11) Same as in the Open Class except that the handler may not give any verbal commands. The handler must use signals only.

16.3.7 **Stand for Examination**

(119-09-11) Following a heeling pattern executed as in the Novice heel free exercise, on the judge's order, while heeling at a normal pace, the handler shall signal the dog to stand in the heel position near one end of the ring. On further order, the handler shall signal the dog to stay, then walk to the far end of the ring, turn and face the dog. The judge will examine the dog as in the Novice Stand for Examination, then order the handler to return to the dog. The handler will return by walking around behind the dog to heel position. The dog shall remain in a standing position until the judge says "Exercise finished."

16.3.8 **Drop on Recall**

(119-09-11) Same as in the Open Class except that the dog must be dropped between 2 lines placed across its path in the center of the ring. The distance between the 2 lines is to be approximately 2.44m (8'). At an indoor trial, the lines can be marked with chalk and at an outdoor trial, by white cord laid on the ground. The dog shall drop between the 2 lines, touching neither one. The handler must use signals only to command the dog, to come, drop and come again. The handler may use a verbal command for the stay and finish. Penalties are the same as in the Open Class except that a dog dropping with more than half of its body over either line must receive a non-qualifying score. A substantial penalty shall be given if any part of the dog's body extends over either line.

16.3.9 **Select and Retrieve Wooden Article**

(119-09-11) Same as in the Scent Discrimination Exercise in the Utility Class except that the dog must find and retrieve the handler's scented wooden article from amongst 4 other wooden articles.

16.3.10 **Directed Jumping**

(119-09-11) The handler shall stand still at the starting point, which shall be at one end of the ring. On the judge's orders, the handler and dog shall heel to the opposite end of the ring then execute an about turn and halt. On the judge's order, the handler will leave the dog and walk to the opposite end of the ring, turn and face the dog. The judge then designates the high jump to be jumped first and the handler, as in the

Utility exercise, will command and/or signal the dog to jump the high jump and complete the exercise as in the Utility class. For the second half of the exercise, the routine and orders are the same, except that the judge designates the bar jump to be jumped. Penalties are the same as in the Directed Jumping Exercise in the Utility Class plus the judge may penalize for poor heeling and a poor sit.

16.3.11 Long Sit

Same as in the Open Class.

16.4 Versatility Class

16.4.1 The Versatility Class is open to any dog that has *(120-09-11)* attained the title of C.D.X. and at least 1 qualifying score towards the Utility title, prior to the closing date of the trial in which it is to be entered.

16.4.2 The owner or any other person may handle dogs in this *(120-09-11)* class. More than one (1) dog may be entered in this class.

16.4.3 A person may enter more than one dog in this class. *(120-09-11)*

16.4.4 These exercises will be performed and judged as *(120-09-11)* specified for the Regular Classes.

16.4.5 The exercises to be performed by each dog will be *(120-09-11)* determined by the handler's drawing 1 of a set of 4 cards listing a combination of 6 exercises after the handler has entered the ring.

16.4.6 Each handler must provide a dumbbell, scent dis- *(120-09-11)* crimination articles and seek back glove.

16.4.7 The 4 routines are:

(120-09-11) Routine #1

- (a) Scent Discrimination Article No. 1 30 points
- (b) Scent Discrimination Article No. 2 30 points
- (c) Broad Jump 20 points
- (d) Novice Recall 30 points
- (e) Retrieve on Flat 25 points
- (f) Seek Back 30 points
- (g) Heel on Leash & Figure 8 35 points

Routine #2

(a) Directed Jumping	40 points
(b) Stand for Examination	30 points
(c) Retrieve over High Jump	35 points
(d) Drop on Recall	30 points
(e) Novice Recall	30 points
(f) Signal Exercise	35 points

Routine #3

(a) Drop on Recall	30 points
(b) Stand for Examination	30 points
(c) Novice Heel Free	45 points
(d) Retrieve on Flat	25 points
(e) Directed Jumping	40 points
(f) Seek Back	30 points

Routine #4

(a) Retrieve on Flat	25 points
(b) Directed Jumping	40 points
(c) Heel on Leash & Figure 8	35 points
(d) Signal Exercise	35 points
(e) Novice Recall	30 points
(f) Retrieve over High Jump	35 points

16.5 Brace Class

16.5.1 The Brace Class is open to any 2 dogs of any breed that (121-09-11) have earned the title of C.D. or higher.

16.5.2 It is not necessary that the same person owns both (121-09-11) dogs, nor that they be the same breed, except when entered in a breed specialty obedience trial.

16.5.3 The owner or any other person may handle dogs in (121-09-11) this class.

16.5.4 A person may enter more than one dog in this class. (121-09-11)

16.5.5 The same handler must handle each dog in all 6 exercises unless he has 2 or more dogs entered. In such case, he must have an additional handler for each extra dog when they are judged together in the Group Exercises.

16.5.6 The Brace Class is performed and judged in the same (121-09-11) manner as the Novice Class. The 2 dogs shall be hitched together with a brace chain or coupling and are judged on the performance of the 2 dogs as though they were one.

16.6 Team Class

16.6.1 The Team Class is open to any 4 dogs of any breed (122-09-11) that have earned the title of C.D. or higher. It is not necessary that the same person own all dogs in the team or that they be of the same breed, except when entered in a breed specialty obedience trial.

16.6.2 Five dogs may be entered, one to be considered as an (122-09-11) alternate. However, the same 4 dogs must compete in all exercises.

16.6.3 The exercises will be performed simultaneously and (122-09-11) judged exactly as specified for the Novice Class with the following exceptions:

(122-09-11) (a) The Figure 8 will be performed in the Heel Free Exercise instead of in the Heel on Leash Exercise.

(122-09-11) (b) The Stand for Examination will be done off leash with the handlers turning to face their dogs after proceeding away from them to a distance of about 1.83m(6')

(122-09-11) (c) For the Drop on Recall Exercise the dogs will first be called and dropped individually, then perform the second portion of the recall and the finish simultaneously. This exercise will be judged as specified for the Open Class.

16.6.4 Judgment will be based on the performance of the (122-09-11) dogs and handlers, plus team precision and coordination.

16.6.5 The scoring shall total 4 times the value of each individual (122-09-11) exercise listed below. Each dog receiving a non-qualifying score of an exercise will be automatically scored zero (that is, a full 1/4 off the total score for that exercise for the 4 dogs).

16.6.6 To qualify, a team must have a final score of 680 or (122-09-11) more points out of the maximum 800 points and must have earned more than 50% of the available points in each exercise.

16.6.7 SCALE OF POINTS

(122-09-11) Heel on Leash....	30 points	Team total.....	120 points
Stand for			
Examination.....	20 points	Team total.....	80 points
Heel Free.....	40 points	Team total.....	160 points
Drop on Recall...	50 points	Team total.....	200 points
Sit Stay.....	30 points	Team total.....	120 points
Down Stay.....	30 points	Team total.....	120 points
Maximum			
Total Score.....	200 points		800 points

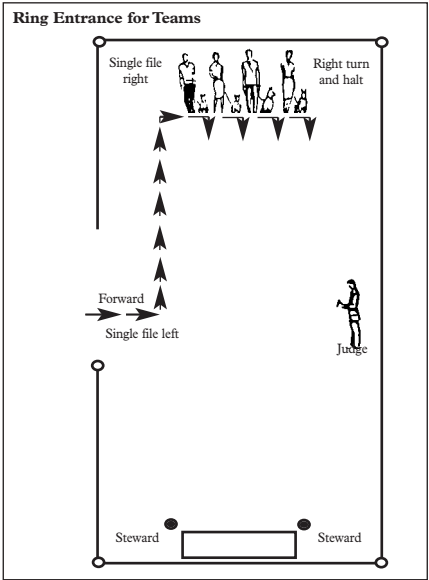

16.6.8 Heel On Leash

(122-09-11) The orders for this exercise shall be the same as for the Heel On Leash exercise in the Novice class except that there shall be no Figure 8.

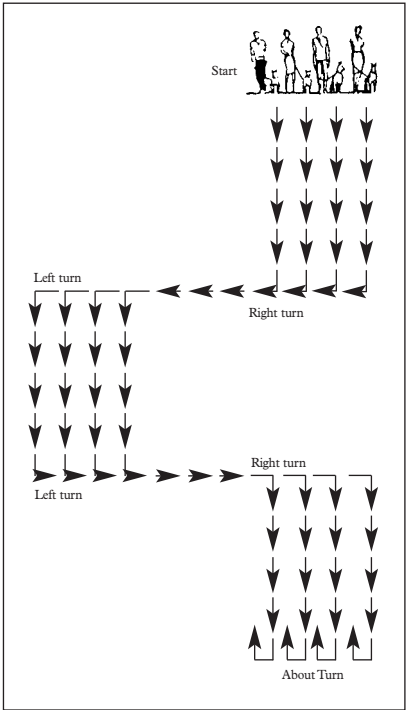

16.6.9 The judge's orders and examination will be the same (122-09-11) as in the Novice Class

16.6.9 Heel Free and Figure 8

(122-09-11) The orders for this exercise shall be the same as for the Heel on Leash Exercise in the Novice Class. On the judge's order "Prepare for Figure Eight" handlers and dogs will take position as shown in diagram. On further order from the judge, the handlers will execute the figure 8 exercise as in the Novice Class except that all handlers will go around the steward on their left first as in the diagram below.

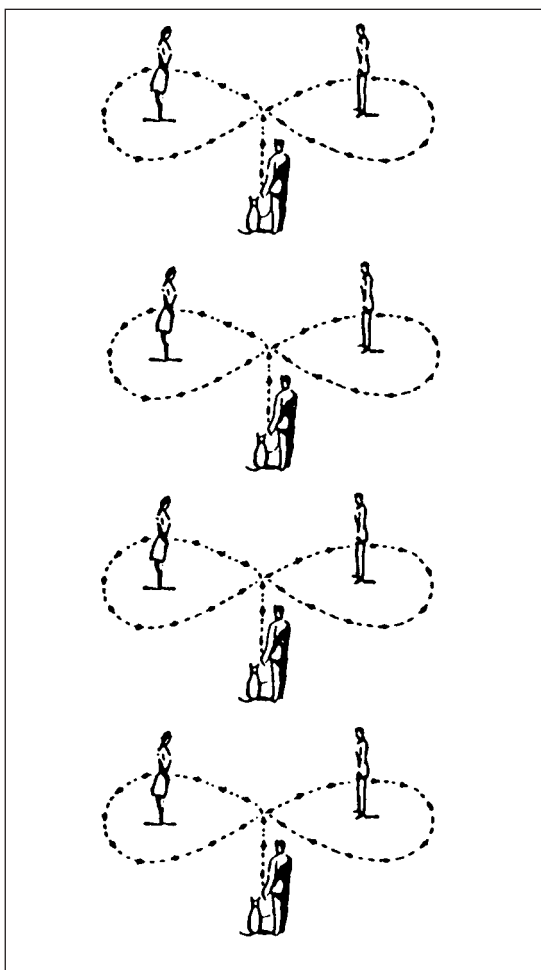

16.6.10 **Drop On Recall**

(122-09-11) The Drop on Recall will be done the same as the Drop on Recall exercise in the Open Class. Handlers will prepare to leave their dogs in a sitting position and on the judge's order, shall walk about 12.19m (40') turn to face their dogs. On the judge's order, to "Call the first dog", the first dog on the handler's right will be called and the handler will drop his dog (without command from the judge) midway between the dogs and the handlers. Each dog will remain in the down position until all 4 dogs have been called and dropped. On the order "Call your dogs" all dogs will be called together and sit in front of their handlers until the judge gives the order to finish. All four dogs should go smartly to heel position.

16.6.11 **Group Sit and Down Exercises**

(122-09-11) The group sit (1 minute) and the group down (3 minutes) will be executed with no more than 2 teams (8 dogs) in the ring at one time.

16.7 **Veteran's Class**

16.7.1 The Veterans Class shall be for any dog that has *(123-09-11)* earned the title of C.D. or higher and is 7 years old or older on the day of the trial.

16.7.2 The exercises shall be performed and judged as in the *(123-09-11)* Novice Classes.

16.7.3 Dogs entered in the Veterans Class must also be *(123-09-11)* entered in any Regular class or for Exhibition Only.

16.7.4 The owner or any other person may handle dogs in *(123-09-11)* this class.

16.7.5 A person may enter more than one dog in this class. *(123-09-11)*

16.7.6 The same handler must handle each dog in all 6 exercises unless he has 2 or more dogs entered. In such *(123-09-11)* case, he must have an additional handler for each extra dog when they are judged together in the Group Exercises.

16.8 Parade of Title Holders & Parade of Veterans

- 16.8.1 Dogs entered in Parades must be entered in a Regular Class or for Exhibition Only. (124-09-11)
- 16.8.2 Details of Parades must be included in the premium (124-09-11) list.
- 16.8.3 A club may offer a Parade of Title Holders open to any dog with an obedience title. (124-09-11)
- 16.8.4 A club may offer a Parade of Veterans open to any dog (124-09-11) 7 years of age or older on the day of the trial.

17 SANCTIONED OBEDIENCE MATCHES

- 17.1 A sanctioned obedience match is a competition at which dogs of six months of age or older, who are recognized or whose breed is included on the Miscellaneous list as designated by the Board, may compete, but not for legs for an obedience title. It is a learning experience for all trial officials, judges, stewards, handlers and exhibitors. A club shall not be permitted to hold more than one match in the same zone within a 3 month period, except at the discretion of the CKC Director for the respective zone.
- 17.2 Any CKC accredited club or association wishing to hold a sanctioned obedience match under CKC rules must obtain the approval of the CKC by submitting an application for a match date, on the form provided by the CKC, to the CKC Director for the respective zone.
- 17.3 The granting of sanctioned obedience match dates is at the discretion of the local CKC Director.
- 17.4 Dates must be applied for not less than 60 days prior to the date of the sanctioned match. Dates are allocated on a first come, first served basis. In special circumstances, the CKC Director for the respective zone may waive the 60 day requirement.
- 17.5 The Provincial or Zone Obedience Representative is responsible for the compilation of a list of persons interested in judging sanctioned obedience matches. Representatives should keep this list of such people, who appear capable of and interested in judging sanctioned obedience matches, up to date. A person

-
- should not be expected to judge classes at a level higher than that in which he has completed titles on a dog unless in special circumstances (i.e. qualified persons not available). Clubs are requested to select judges from the lists prepared by the Obedience Representatives where possible and should contact their Obedience Representatives before appointing judges.
- 17.6 A club holding a sanctioned match must appoint an obedience chair as well as a trial secretary and ring stewards. Clubs holding sanctioned obedience matches are required to have available copies of the latest edition of these Obedience Trial Rules & Regulations at all sanctioned matches.
- 17.7 Classes may be provided for all Official Classes and Unofficial Classes. Utility Class may be held only if Open and Novice Classes are offered; Open Classes may be held only if Novice Classes are offered. Unofficial Obedience Classes may be held, only if all Official Obedience Classes are offered. The order of judging is at the discretion of the club. A dog may not enter a class for which it has received a title. A dog with a title may go through the routine, but it is not eligible for ribbons or prizes. Unofficial Classes may be held at any time where they do not interfere with Regular Classes.
- 17.8 No score made at a sanctioned obedience match shall be considered as qualifying or as a leg towards a title.
- 17.9 The Obedience Trial Rules & Regulations, with the exception of those sections pertaining to titles, shall apply at all sanctioned obedience matches.
- 17.10 Ribbons or cards can be given at sanctioned obedience matches for Passing Scores and the following information must appear on the face of each ribbon/rosette: name of the club or association holding the match, "Sanctioned Obedience Match" and "Passing Score". Passing Score ribbons must be gold in colour. High in Class and High in Match ribbons/rosettes must be gold and white and clearly indicate the awards for which they are presented. All other ribbons offered must be dark green. A dog shall not be given a ribbon or a card if the dog has not earned more than 50% of the available points in each of the exercises and a total score of at least 170 points in a class.
- 17.11 The judge's books must be made up of obedience trial judges' sheets or a facsimile thereof as per the Obedience Trial Rules & Regulations.
- 17.12 The set-up procedure followed at sanctioned obedience matches should follow approved obedience trials.
-

18 PROTESTS

- 18.1 A protest against a dog may be made, by an exhibitor/handler, any member of the CKC, or a member of the club or association holding the obedience trial. It must be in writing, on a form provided by the CKC (or facsimile thereof), and be lodged with the Show Superintendent or Obedience Trial Committee Chair before the closing of the trial. A hearing shall be held prior to the departure of all parties. No protest will be entertained unless accompanied by a deposit. This deposit will be returned if the protest is sustained. If the protest is not sustained, the deposit will be forwarded to the CKC with the Obedience Trial Committee's report.
- 18.2 Where the Obedience Trial Committee consists of more than 5 persons, the Show Superintendent or Obedience Trial Committee Chair of the trial-giving club shall name 5 members of the Obedience Trial Committee to act on any protest received by the trial-giving club.
- 18.3 Written copies of all decisions on protests must be forwarded immediately to the Discipline Committee of the CKC. The Discipline Committee may take such action as it deems fit in connection with such protest, provided no appeal is submitted to the CKC within 10 days of the event on which the decision of the Obedience Trial Committee was rendered. Such action may include barring the dog from future CKC approved events, imposition of an administrative fee, and/or cancellation of awards. The fact that the Obedience Trial Committee did not sustain a protest in no way inhibits the right of the Discipline Committee to take such action, as it deems advisable.
- 18.4 An appeal to the Discipline Committee of the CKC from a decision of the Obedience Trial Committee where a dog has been protested must be forwarded to the CKC within 10 days of the date on which the decision was rendered, together with a deposit.
- 18.5 If a trial-giving club fails to hear a protest as prescribed above, or in the opinion of the Discipline Committee improperly handles a protest, the Discipline Committee shall have the authority to take such action as it deems fit and necessary, and it may at the same time take disciplinary action against the officials of the trial-giving club concerned.

19 COMPLAINTS

- 19.1 A complaint against a person regarding a violation of the rules and regulations related to obedience trials must be in writing, on a form issued by the CKC (or facsimile thereof), and must be accompanied by a deposit. A deposit is not required on a complaint alleging that a judge officiating at an obedience trial held under these rules and regulations has been subject to indignities of any kind during the progress of the trial.
- 19.2 A complaint should be lodged with the Show Superintendent or Obedience Trial Committee Chair of the trial-giving club no later than 15 minutes after the completion of judging of the trial, or should the complainant choose to do so, a complaint may be submitted directly to the CKC within 10 days of the trial. All such complaints shall constitute complaints under the CKC By-laws and the provisions of same shall apply.
- 19.3 Any complaint against the club holding the trial or any of its officials must be submitted directly to the CKC within 10 days of the trial. All such complaints shall constitute complaints under the CKC By-laws and the provisions of same shall apply.
- 19.4 A complaint shall be restricted to any of the following:
- (a) An act of omission or commission on which is based an allegation of a violation of the Obedience Trial Rules & Regulations.
 - (b) Any act on which an allegation of misconduct is based.
 - (c) The alleged failure of an officiating judge to excuse or remove from competition a dog for which a provision for excusing or removal from competition appears in these rules and regulations.
- 19.5 Where the Obedience Trial Committee consists of more than 5 persons, the Show Superintendent or Obedience Trial Committee Chair shall name 5 members to form an Obedience Trial Committee to act on complaints received by the trial-giving club.

-
- 19.6 When a complaint is received against a judge by the trial-giving club, the club will hold a hearing while all parties are still in attendance. The report and all statements given by all parties will be forwarded to the Discipline Committee along with the deposit from the complainant. The Obedience Trial Committee will not render a decision but will collect all pertinent information.
- 19.7 Upon receipt of a complaint the Obedience Trial Committee of the trial-giving club shall conduct an investigation as soon as possible thereafter, but in any event, within 14 days of receipt, conduct a hearing in accordance with procedures set out in the Procedure for Conducting an Obedience Trial Committee hearing as provided in these regulations.
- 19.8 The Obedience Trial Committee shall promptly forward the complaint, the deposit and a record of the hearing together with its recommendation on the disposition of the complaint to the CKC. Copies of the record of the hearing and the Committee's recommendation will be forwarded to the parties concerned at the same time.
- 19.9 Notwithstanding any contrary provisions in these rules and regulations, the procedure specified herein for dealing with complaints shall govern.
- 19.10 Disciplinary action will be taken against any official and the trial-giving club of which he is an official when it is established to the satisfaction of the CKC that an attempt was made to discourage the submission of a complaint.
- 19.11 Disciplinary action will be taken against a trial-giving club which fails to properly deal with complaints as provided in these rules and regulations.

20 DISCIPLINE

- 20.1 The Discipline Committee may take disciplinary action against any club, person, partnership, company or organization for any act of omission or commission, which violates any section or sections of the rules and regulations for CKC obedience trials. Such action will be taken as provided for in the By-laws of the CKC.

-
- 20.2 No person shall abuse a dog on the grounds or premises of a trial or conduct themselves in a manner considered prejudicial to the best interests of the trial.
- 20.3 Any club, member, person, partnership, company or organization availing themselves of the privilege of participating in any capacity or manner whatsoever at an obedience trial shall, by such participation, be deemed to have agreed to the authority of the CKC and its Board as conferred on the CKC by its By-laws and all other rules and regulations adopted by the CKC.
- 20.4 At its discretion and subject to the appeal process, the Discipline Committee may cancel any or all qualifying scores earned by a dog owned by a person debarred, deprived, suspended or expelled of all privileges of the CKC when such wins were earned following the date on which such act occurred that resulted in disciplinary action.
- 20.5 The administration to a dog competing at an obedience trial of a drug or any substance, in any form, which alters the nervous system by stimulation, sedation or tranquilization shall be considered as misleading the judge and will be considered misconduct. The person or persons responsible will be subject to disciplinary action in accordance with this section.
- 20.6 Any person, either within or outside the judging ring, who does anything calculated to attract, distract or otherwise interfere in any way with the attention, deportment, or performance of a dog under judgment, may be disciplined by the Discipline Committee in whatever way it considers to be in the best interest of the club, or the judge may take summary action.
- 20.7 It shall be the duty and obligation of the trial-giving club to see that a judge, club official, ring steward, volunteer, or competitor at an Obedience Trial held under these regulations, is not subject to indignities of any kind. The Obedience Trial Committee Chair shall promptly report to the CKC any infringement of this regulation, and the Discipline Committee shall have the authority to take such action as it deems fit on receipt of a report indicating that this has occurred. A copy of this regulation shall be prominently placed in every premium list and catalogue.

21 PROCEDURE FOR CONDUCTING AN OBEDIENCE TRIAL COMMITTEE HEARING

- 21.1 It is essential that the defendants be given the opportunity to be present during the whole hearing and to testify and present their own witnesses. If a defendant refuses to attend or defend himself, the hearing may proceed without him. In notifying the defendant of the hearing, it is essential that he be informed specifically of the nature of the charges against him and that a record of such notice be made.
- 21.2 The complainant must also be informed of the hearing and allowed to be present throughout the whole hearing.
- 21.3 Both the complainant and defendant should be informed that they may be represented by legal counsel or an agent at the hearing if they choose but this is not necessary.
- 21.4 The chair is to call the meeting to order and then announce: "We are proceeding by reason of our appointment to the Obedience Trial Committee by (name of trial-giving club)."
- 21.5 The chair shall identify all persons present and the reason for their presence (i.e. complainant, defendant, witness) and then ask the witnesses to withdraw until required to give evidence. After giving evidence a witness may be excused.
- 21.6 The complaint is to be read except that if the complainant and defendant agree, it may be necessary to relate only the substance of the complaint as set out on the Official Complaint form.
- 21.7 The chair is to ask the defendant whether he wishes to admit or deny the complaint as it has been read or stated.
- 21.8 The complainant is to give evidence on the complaint. The defendant then may question him. At the chair's invitation, any member of the Committee may question the complainant. If the complainant has brought witnesses, such witnesses may then give evidence individually. Each witness may be questioned by the defendant or any member of the Committee. Each witness is to leave the hearing after evidence has been given.

-
- 21.9 Upon completion of the evidence given by the complainant and any witnesses appearing on his behalf, the defendant may then give evidence and may then be questioned by the complainant or any member of the Committee. If the defendant has brought witnesses, such witnesses may then give evidence individually. Each witness may be questioned by the complainant or any member of the Committee.
- 21.10 The chair may then call any other witness, which the Committee considers appropriate to the proper hearing of the complaint.
- 21.11 The complainant may then have the opportunity of summing up the complaint and the evidence presented in support thereof. The defendant shall have the opportunity of summing up his own defense and any evidence presented in support of his own defense.
- 21.12 The Chair shall announce that the Committee will be submitting a report on the hearing together with its recommendation on the disposition of the complaint to the Discipline Committee of the CKC and the parties concerned. All but the Committee members shall be dismissed so that the matter may be considered.
-

22 PARTICIPATION

- 22.1 The participation in any manner or in any capacity at a competitive event held under these rules shall be considered a privilege accorded to any person by the CKC and such privilege may be extended and withdrawn by the Discipline Committee.
- 22.2 Any person availing himself of the privilege of participating in any manner, shape or form and in any capacity, including that of a spectator at a competitive event held under these rules shall, by such participation, be deemed to have agreed to the authority of the CKC and its Board.
- 22.3 No person who has been expelled, deprived of privileges, suspended or debarred by the CKC may enter a dog, compete, exhibit, judge, act as agent or handler for any competitor, take a dog into any competition or be connected in any capacity with competitive events held under these rules.
-

-
- 22.4 A club holding an obedience trial under these rules shall not engage in any capacity a person who is under suspension or expulsion, debarred or deprived of privileges by the CKC.
- 22.5 Any person who has lost the right to participate in events in their country of residence shall not, while such a loss of privilege is in effect, participate in any Canadian Kennel Club approved event. Any wins by a dog that is exhibited or handled by such individual shall automatically be canceled.
-

23 NO LIABILITY

- 23.1 The CKC shall not be responsible to any member, person, partnership, club or corporation for any loss, damage or injury arising at or by reason of any obedience trial held under any rules adopted by the CKC.
-

24 AMENDMENTS

- 24.1 These rules are subject to amendment by the Board.
- 24.2 Amendments to these rules may also be proposed by a person, association, club, representative group or body by presenting such proposal to the Board for its consideration. In such circumstances, the Board will forward the proposal to the Obedience Council for its consideration and input, prior to the Board making its final decision.
- 24.3 Any amendment to these rules shall be approved by a simple majority vote of the Board.
- 24.4 The effective date of any approved amendment shall be set by the Board.
- 24.5 The Board, at its sole discretion, may choose to perform a non-binding poll of the membership to attain general input prior to making a final decision on any proposed amendment to these rules.
- 24.6 Upon the Board making its final decision with respect to any amendment to these rules, the membership shall be advised by placing a notice in the Official Section as soon thereafter as is reasonably possible.
-

APPENDIX A

OBEDIENCE TRIAL SAMPLE JUDGING CHARTS

for PRE-NOVICE, NOVICE, NOVICE INTERMEDIATE, OPEN & UTILITY

Section 9
(125-09-11)

Pre-Novice Class
Obedience Trial Sample Judging Chart

CANADIAN KENNEL CLUB  CLUB CANIN CANADIEN							
JUDGE'S BOOK FOR OBEDIENCE TRIAL / LIVRE DU JUGE POUR CONCOURS D'OBÉISSANCE							
PRE-NOVICE CLASS / CLASSE PRÉ-NOVICE							
SCORE – QUALIFY OR NON-QUALIFY POINTAGE – QUALIFICATION OU NON-QUALIFICATION							
CATALOGUE No. N° DE CATALOGUE	10	11	12	13	14	15	16
HEEL ON LEASH MARCHE AU PIED EN LAISSE	Q	Q	Q	NQ	Q	A	Q
FIGURE EIGHT HUITE DE CHIFFRE	Q	Q	Q	Q	Q	B	Q
SIT FOR EXAMINATION ASSIS POUR EXAMEN	Q	NQ	Q	Q	Q	S	Q
RECALL RAPPEL	NQ	Q	Q	Q	Q	E	Q
LONG SIT ASSIS PROLONGÉ	Q	Q	Q	Q	Q	N	Q
LESS PENALTY MOINS PENALITÉ							
TOTAL SCORE POINTAGE TOTAL	NQ	NQ	Q	NQ	Q		Q
FINAL QUALIFYING SCORE POINTAGE DE QUALIFICATION FINAL			Q		Q		Q

QUALIFYING SCORES EARNED BY DOGS No.
POINTAGES DE QUALIFICATION DÉCERNÉS
AUX CHIENS N° _____

NOTE TO JUDGE: It is imperative that the rating earned by a dog in each test be marked in the applicable square on this report.

NOTA : la note obtenue par un chien dans chaque exercice doit être inscrite dans la case appropriée.

Section 10
(125-09-11)

Novice Class
Obedience Trial Sample Judging Chart



CANADIAN KENNEL CLUB

CLUB CANIN CANADIEN

JUDGE'S BOOK FOR OBEDIENCE TRIAL / LIVRE DU JUGE POUR CONCOURS D'OBÉISSANCE

NOVICE CLASS / CLASSE NOVICE

Enter points off for each exercise under appropriate dog number /
Inscrire dans la case du chien concerné le nombre de points retirés pour chaque exercice

CATALOGUE No. N° DE CATALOGUE	21	22	23	24	25	26		
HEEL ON LEASH & FIGURE 8 MARCHE AU PIED EN LAISSE ET HUIT DE CHIFFRE	2.5	6.5	A	5.5	2.5	3		
STAND FOR EXAMINATION DEBOUT POUR EXAMEN	0	NQ	B	EXC	0	0		
HEEL FREE MARCHE AU PIED SANS LAISSE	2	8	S		2.5	3.5		
RECALL RAPPEL	0.5	2.5	E		0.5	1.5		
SUB TOTAL TOTAL PARTIEL	5	NQ	N		5.5	8		
LONG SIT ASSIS PROLONGÉ	0	0	T		0	NQ		
LONG DOWN COUCHÉ PROLONGÉ	0	0			0	NQ		
LESS PENALTY MOINS PÉNALITÉ								
MAXIMUM SCORE POINTAGE MAXIMAL	200 points	200 points	200 points	200 points	200 points	200 points	200 points	200 points
TOTAL POINTS OFF / TOTAL DES POINTS RETIRÉS	5	NQ			5.5	EXC		
TOTAL SCORE POINTAGE TOTAL	195	NQ			194.5	EXC		
FINAL QUALIFYING SCORE POINTAGE DE QUALIFICATION FINAL	195				194.5			

QUALIFYING SCORES EARNED BY DOGS No.
POINTAGES DE QUALIFICATION DÉCERNÉS
AUX CHIENS N° _____

NOTE TO JUDGE: It is imperative that the rating earned by a dog in each test be marked in the applicable square on this report.

NOTA : la note obtenue par un chien dans chaque exercice doit être inscrite dans la case appropriée.

Section 11
(125-09-11)

Open A Class
Obedience Trial Sample Judging Chart



CANADIAN KENNEL CLUB

CLUB CANIN CANADIEN

JUDGE'S BOOK FOR OBEDIENCE TRIAL / LIVRE DU JUGE POUR CONCOURS D'OBÉISSANCE

OPEN A CLASS / CLASSE OUVERTE A

Enter points off for each exercise under appropriate dog number /
Inscrire dans la case du chien concerné le nombre de points retirés pour chaque exercice

CATALOGUE No. N° DE CATALOGUE	31	32	33	34	35	36	
HEEL FREE MARCHE AU PIED SANS LAISSE	1.5	2	5	2.5	NQ	0.5	
DROP ON RECALL COUCHÉ SUR RAPPEL	0.5	NQ	2	1	2.5	0	
RETRIEVE ON FLAT RAPPORT	0.5	0.5	1.5	0.5	2	0	
RETRIEVE OVER HIGH JUMP RAPPORT AU-DESSUS DU SAUT EN HAUTEUR	1	1.5	2.5	1	1.5	0	
BROAD JUMP SAUT EN LONGUEUR	0.5	1	1	0.5	0.5	0	
SUB TOTAL TOTAL PARTIEL	4	NQ	12	5.5	NQ	0.5	
LONG SIT ASSIS PROLONGÉ	0	0	25	0	0	0	
LONG DOWN COUCHÉ PROLONGÉ	0	0	0	0	0	0	
LESS PENALTY MOINS PÉNALITÉ	0	0	EXC	0	NQ	0	
MAXIMUM SCORE POINTAGE MAXIMAL	200 points	200 points	200 points	200 points	200 points	200 points	200 points
TOTAL POINTS OFF / TOTAL DES POINTS RETIRÉS	4	NQ	EXC	5.5	NQ	0.5	
TOTAL SCORE POINTAGE TOTAL	196	NQ	EXC	194.5	NQ	199.5	
FINAL QUALIFYING SCORE POINTAGE DE QUALIFICATION FINAL	196			194.5		199.5	

QUALIFYING SCORES EARNED BY DOGS No.
POINTAGES DE QUALIFICATION DÉCERNÉS
AUX CHIENS N° _____

NOTE TO JUDGE: It is imperative that the rating earned by a dog in each test be marked in the applicable square on this report.

NOTA : la note obtenue par un chien dans chaque exercice doit être inscrite dans la case appropriée.



CANADIAN KENNEL CLUB

CLUB CANIN CANADIEN

JUDGE'S BOOK FOR OBEDIENCE TRIAL / LIVRE DU JUGE POUR CONCOURS D'OBÉISSANCE

OPEN B CLASS / CLASSE OUVERTE B

ORDER OF EXERCISES (1 - 6) <u>4</u> ORDRE DES EXERCICES (1 - 6) <u>4</u>	Enter points off for each exercise under appropriate dog number / Inscrire dans la case du chien concerné le nombre de points retirés pour chaque exercice							
CATALOGUE No. N° DE CATALOGUE	41	42	43	44				
DROP ON RECALL COUCHÉ SUR RAPPEL	0.5	NQ	0.5	0.5				
HEEL FREE & FIGURE 8 MARCHÉ AU PIED SANS LAISSE ET HUIT DE CHIFFRE	3.5	2.5	1.5	2.5				
RETRIEVE OVER HIGH JUMP RAPPORT AU-DESSUS DU SAUT EN HAUTEUR	NQ	1.5	1	1.5				
BROAD JUMP SAUT EN LONGUEUR	0.5	0.5	0.5	1				
RETRIEVE ON FLAT RAPPORT	1.5	1	0.5	0.5				
SUB TOTAL TOTAL PARTIEL	NQ	NQ	4	6				
LONG SIT ASSIS PROLONGÉ	0	0	0	0				
LONG DOWN COUCHÉ PROLONGÉ	0	0	0	0				
LESS PENALTY MOINS PÉNALITÉ			5					
MAXIMUM SCORE POINTAGE MAXIMAL	200 points	200 points	200 points	200 points	200 points	200 points	200 points	200 points
TOTAL POINTS OFF / TOTAL DES POINTS RETIRÉS	NQ	NQ	9	6				
TOTAL SCORE POINTAGE TOTAL	NQ	NQ	191	194				
FINAL QUALIFYING SCORE POINTAGE DE QUALIFICATION FINAL			191	194				

QUALIFYING SCORES EARNED BY DOGS No.
POINTAGES DE QUALIFICATION DÉCERNÉS
AUX CHIENS N° _____

NOTE TO JUDGE: It is imperative that the rating earned by a dog in each test be marked in the applicable square on this report.

NOTA : la note obtenue par un chien dans chaque exercice doit être inscrite dans la case appropriée.

Section 13
(125-09-11)

Novice Intermediate Class
Obedience Trial Sample Judging Chart



CANADIAN KENNEL CLUB

CLUB CANIN CANADIEN

JUDGE'S BOOK FOR OBEDIENCE TRIAL / LIVRE DU JUGE POUR CONCOURS D'OBÉISSANCE

NOVICE INTERMEDIATE CLASS / CLASSE NOVICE INTERMÉDIAIRE

Enter points off for each exercise under appropriate dog number /
Inscrire dans la case du chien concerné le nombre de points retirés pour chaque exercice

CATALOGUE No. N° DE CATALOGUE	51	52	53				
HEEL FREE & FIGURE 8 MARCHÉ AU PIED SANS LAISSE ET HUIT DE CHIFFRE	2.5	1	3.5				
STAND FOR EXAMINATION (Off Leash) DEBOUT POUR EXAMEN (sans laisse)	0	0.5	0.5				
DROP FROM HEEL AU PIED COUCHÉ	1	0.5	NQ				
RECALL HOLDING DUMBBELL RAPPEL EN TENANT L'HALTÈRE	0.5	1	1.5				
RECALL OVER HIGH JUMP HOLDING DUMBBELL RAPPEL AU DESSUS DU SAUT EN HAUTEUR EN TENANT L'HALTÈRE	0.5	0.5	2.5				
RECALL OVER BROAD JUMP RAPPEL AU DESSUS DU SAUT EN HAUTEUR EN TENANT L'HALTÈRE	0	0.5	0.5				
LESS PENALTY MOINES PÉNALITÉ							
MAXIMUM SCORE POINTAGE MAXIMAL	200 points	200 points	200 points	200 points	200 points	200 points	200 points
TOTAL POINTS OFF / TOTAL DES POINTS RETIRÉS	4.5	4	NQ				
TOTAL SCORE / POINTAGE TOTAL	195.5	196	NQ				
FINAL QUALIFYING SCORE POINTAGE DE QUALIFICATION FINAL	195.5	196					

QUALIFYING SCORES EARNED BY DOGS No.

POINTAGES DE QUALIFICATION DÉCERNÉS
AUX CHIENS N°

NOTE TO JUDGE: It is imperative that the rating earned by a dog in each test be marked in the applicable square on this report.

NOTA : la note obtenue par un chien dans chaque exercice doit être inscrite dans la case appropriée.

Section 14
(125-09-11)

Utility A Class
Obedience Trial Sample Judging Chart



CANADIAN KENNEL CLUB

CLUB CANIN CANADIEN

JUDGE'S BOOK FOR OBEDIENCE TRIAL / LIVRE DU JUGE POUR CONCOURS D'OBÉISSANCE

UTILITY A CLASS / CLASSE UTILITÉ A

Enter points off for each exercise under appropriate dog number /
Inscrire dans la case du chien concerné le nombre de points retirés pour chaque exercice

CATALOGUE No. N° DE CATALOGUE	61	62	63	64	65		
SEEK BACK CHERCHE ET RAPPORTE	0	0.5	2.5	2.5	0.5		
SCENT DISCRIMINATION Article 1 DéTECTION AU FLAIR Article n° 1	0.5	1	3	2	0.5		
SCENT DISCRIMINATION Article 2 DéTECTION AU FLAIR Article n° 2	1.5	0.5	3.5	2.5	0		
SIGNAL EXERCISE EXERCICE SUR SIGNAUX	0.5	1.5	1.5	6.5	0.5		
MOVING STAND DéPLACEMENT AVEC ARRÊTS ET EXAMEN	0.5	0.5	0	EXC	0		
DIRECTED JUMPING SAUTS DIRIGÉS	6.5	1	NQ		0.5		
LESS PENALTY MOINS PÉNALITÉ							
MAXIMUM SCORE POINTAGE MAXIMAL	200 points	200 points	200 points	200 points	200 points	200 points	200 points
TOTAL POINTS OFF / TOTAL DES POINTS RETIRÉS	9.5	5	NQ		2		
TOTAL SCORE POINTAGE TOTAL	190.5	195	NQ		198		
FINAL QUALIFYING SCORE POINTAGE DE QUALIFICATION FINAL	190.5	195			198		

QUALIFYING SCORES EARNED BY DOGS No.
POINTAGES DE QUALIFICATION DÉCERNÉS
AUX CHIENS N° _____

NOTE TO JUDGE: It is imperative that the rating earned by a dog in each test be marked in the applicable square on this report.
NOTA : la note obtenue par un chien dans chaque exercice doit être inscrite dans la case appropriée.

Section 15
(125-09-11)

Utility B Class
Obedience Trial Sample Judging Chart



CANADIAN KENNEL CLUB **CLUB CANIN CANADIEN**
JUDGE'S BOOK FOR OBEDIENCE TRIAL / LIVRE DU JUGE POUR CONCOURS D'OBÉISSANCE

UTILITY B CLASS / CLASSE UTILITÉ B

ORDER OF EXERCISES (1 – 6) 5 Enter points off for each exercise under appropriate dog number /
ORDRE DES EXERCICES (1 – 6) 5 Inscrire dans la case du chien concerné le nombre de points
retirés pour chaque exercice

CATALOGUE No. N° DE CATALOGUE	71	72	73	74				
MOVING STAND DÉPLACEMENT AVEC ARRÊTS ET EXAMEN	0.5	0	1.5	1				
DIRECTED JUMPING SAUTS DIRIGÉS	3	0.5	NQ	3.5				
SIGNAL EXERCISE EXERCICE SUR SIGNAUX	1.5	0	0.5	1.5				
SEEK BACK CHERCHE ET RAPPORTE	0.5	0	0	0.5				
SCENT DISCRIMINATION Article 1 DÉTECTION AU FLAIR Article n° 1	1	0.5	0.5	1.5				
SCENT DISCRIMINATION Article 2 DÉTECTION AU FLAIR Article n° 2	2	0	0.5	1				
LESS PENALTY MOINS PÉNALITÉ								
MAXIMUM SCORE POINTAGE MAXIMAL	200 points	200 points	200 points	200 points	200 points	200 points	200 points	200 points
TOTAL POINTS OFF / TOTAL DES POINTS RETIRÉS	8.5	1		9				
TOTAL SCORE POINTAGE TOTAL	191.5	199		191				
FINAL QUALIFYING SCORE POINTAGE DE QUALIFICATION FINAL	191.5	199		191				

QUALIFYING SCORES EARNED BY DOGS No.
POINTAGES DE QUALIFICATION DÉCERNÉS
AUX CHIENS N° _____

NOTE TO JUDGE: It is imperative that the rating earned by a dog in each test be marked in the applicable square on this report.

NOTA : la note obtenue par un chien dans chaque exercice doit être inscrite dans la case appropriée.

APPENDIX B

PREMIUM LIST

(126-09-11)

1. The following information must appear on the cover or first inside page excluding the inside cover of the premium list:
 - (a) The words “Official Premium List”
 - (b) The name of the club or association holding the event
 - (c) The type of event being held (i.e. All Breed Obedience Trial, Specialty Obedience Trial, etc.)
 - (d) Dates of the events
 - (e) Date and time of the official closing of entries. (Closing date must not be less than 10 days prior to the date of the trial.)

2. The following information must appear in a Premium List:
 - (a) Exact location of the event (may include a map showing the location of the site)
 - (b) The statement “These events held under the rules of The Canadian Kennel Club”
 - (c) A statement whether the trial is indoors, outdoors or both
 - (d) If the trial is outdoors, a statement as to whether or not cover will be provided in case of inclement weather
 - (e) A list of the club officers (addresses may be given if desired)
 - (f) A list of the Obedience Trial Committee including the address and phone number of the Obedience Trial Secretary
 - (g) The address and phone number of where entries are to be sent (if different from the Obedience Trial Secretary)
 - (h) A statement as to where entries are to be sent
 - (i) A list of the judges and their mailing addresses
 - (j) A listing of each judge’s assignments for each day
 - (k) A list of awards and prizes, if offered (Note: trophies do not need to be described in detail)

-
- (l) If money is to be offered as a prize, the amount for each award must be stated
 - (m) The amount of entry fee for each class
 - (n) The name of the Chief Executive Officer of The Canadian Kennel Club and the address of the Head Office
 - (o) The name of the CKC Director for that zone
 - (p) The name of the Obedience Representative for that zone
 - (q) A statement defining the precincts of the trial. A building or specific area may be designated, but it must be clearly defined
 - (r) A statement whether the trials are limited or unlimited (as per 4.4.1)
 - (s) A statement to include the wording of section 20.7 from the discipline section regarding indignities.
3. Clubs are free to include other rules and regulations as they deem necessary. However, if other rules are included, they become part of the Premium List and will be enforced.
-

APPENDIX C

CATALOGUE

(127-09-11)

1. The following information must be listed on the outside front cover or the first page of the catalogue:
 - (a) The name of the club or association holding the event
 - (b) The dates of the trials
 - (c) The statement "These events held under the rules of The Canadian Kennel Club"
 - (d) Exact location of the trial
 - (e) List of the Obedience Trial Committee including the Obedience Trial Chair
 - (f) Name, address and phone number of the Trial Secretary
 - (g) The name and address of The Canadian Kennel Club
 - (h) The name, address and telephone number of the CKC Director and the CKC Obedience Representative for the zone in which the trial is to be held
-

-
- (i) A complete list of the judges and their mailing address
 - (j) A listing of each judge's assignments for each day
2. The information in the catalogue for each dog must be in the following order:
- (a) Catalogue number of the dog
 - (b) Registered name of the dog (in capital letters only)
 - (c) Breed of dog
 - (d) Canadian Kennel Club registration number (if given), or indicate "listed"
 - (e) Date of birth
 - (f) Name of breeder(s)
 - (g) Registered name of sire
 - (h) Registered name of dam
 - (i) Place of birth
 - (j) Name of owner(s)
 - (k) Agent (if applicable)
 - (l) Required jump height if applicable

APPENDIX D

END OF TRIAL

(128-09-11)

1. At the end of a trial, the club must forward to the CKC all of the information outlined below so as to be received not more than 21 days after the last day of the trial:
 - (a) One marked catalogue indicating the scores made in all classes and all absentees noted.
 - (b) One unmarked catalogue.
 - (c) All entry forms;
 - (d) All judges' books marked and signed by the officiating judge;
 - (e) All recording fees as prescribed by the CKC;
 - (f) All listing fees for the entries of non-registered dogs;
 - (g) The signed certification over the signature of any one of the club's executive or other authorized signing officer which will include the total number of listed, absent and total dogs entered in competition.
 - (h) Apprentice judge's books and reports
 - (i) All Observers' Forms duly completed and sealed in separate envelopes.
 - (j) A form for each judge showing the calculation of times for each class that they judged and a total for the day. These calculations shall be in minutes and shall be based on the entries at the time of closing.
 - (k) Any other information or reports as may be required by the CKC

APPENDIX E

CONSTRUCTION SPECIFICATIONS

(DETAILS OF JUMPS)

Details of High Jump

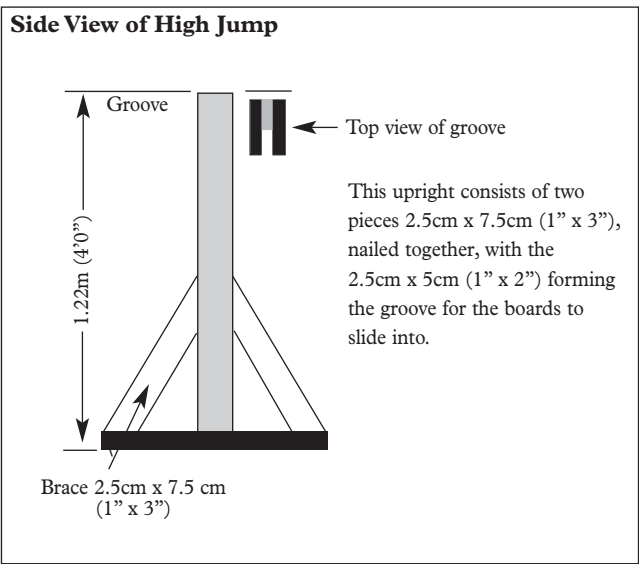
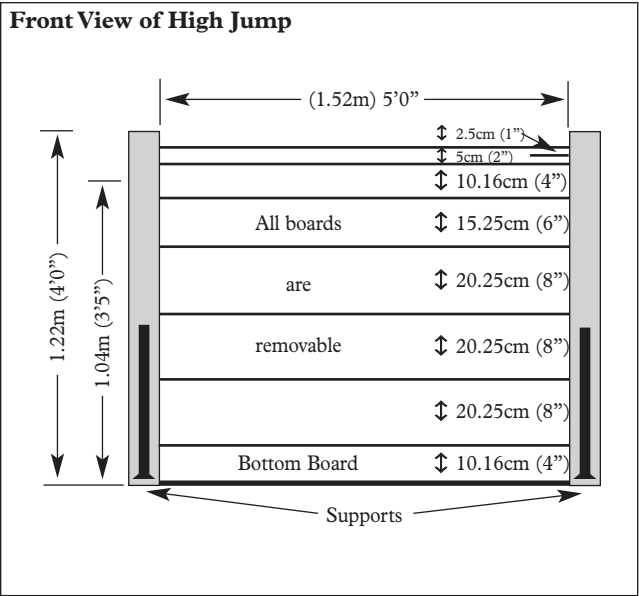

Details of Broad Jump

Front View of Broad Jump

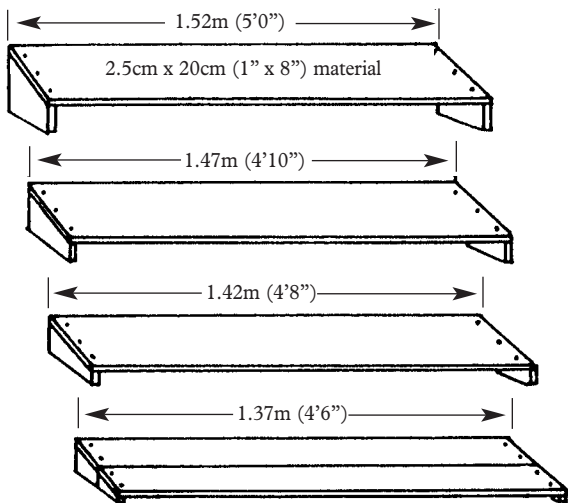

End View of Four Hurdles

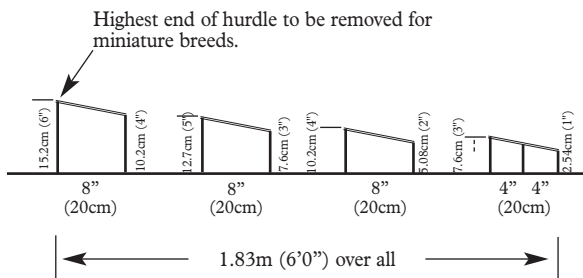

This jump is made of four separate hurdles, spaced so as to make jump 1.83m (6 feet) overall. The four sections, built to telescope for convenience, are painted a flat white.

NOTE:

The lowest hurdle consists of two 10.2"cm (4") hurdles pushed together.

Details of Bar Jump

Front View of Bar Jump

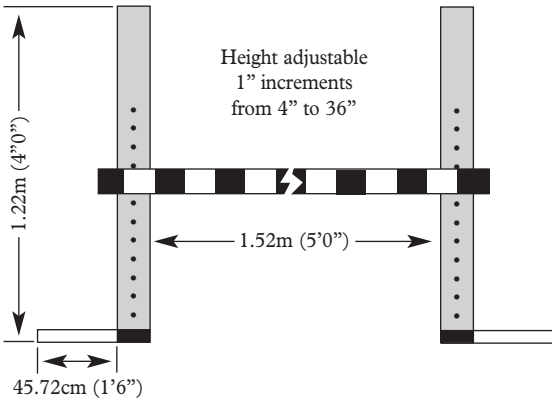

Side View of Bar Jump

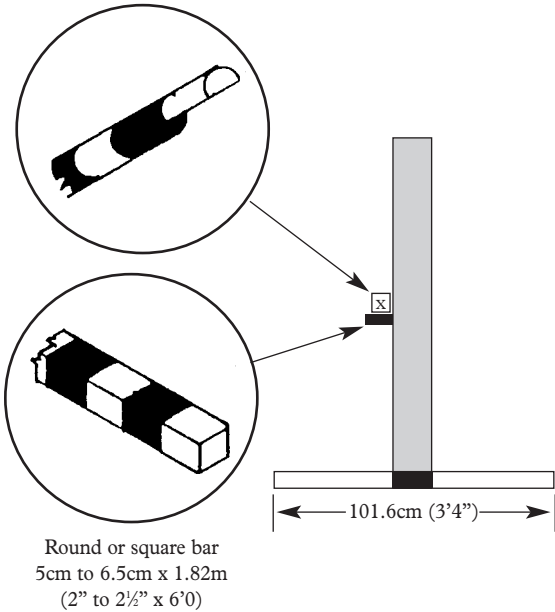

APPENDIX F

BREED SPECIFICATIONS

(RETRIEVE OVER HIGH JUMP)

Small Breeds:

Basset Hound
Bulldog
Cesky Terrier
Clumber Spaniel
Dachshunds (all six varieties)
Dandie Dinmont
French Bulldog
Pekingese
Petit Basset Griffon Vendeen
Scottish Terrier
Sealyham Terrier
Skye Terrier
Welsh Corgi

Giant Breeds:

Bernese Mountain
Black Russian Terrier
Bloodhound
Bullmastiff
Great Dane
Great Pyrenees
Greater Swiss Mountain Dog
Irish Wolfhound
Leonberger
Mastiff
Neopolitan Mastiff
Newfoundland
Saint Bernard

Veteran dogs at least 7 years of age on the day of the trial, at the option of the handler

APPENDIX G

JUMP HEIGHTS

Breeds jumping 3/4 of their height at the shoulders jump the following heights for High and Bar Jumps, and twice that distance for the Broad Jump. Veteran dogs, at the option of the handler, may jump 3/4 of the height required for their breeds.

Measured height of dog at withers	Height to be jumped
15 cm (6")	10 cm (4")
17.5 cm (7")	12.5 cm (5")
20 cm (8")	15 cm (6")
22.5 cm (9")	17.5 cm (7")
25 cm (10")	17.5 cm (7")
27.5 cm (11")	20 cm (8")
30 cm (12")	22.5 cm (9")
32.5 cm (13")	25 cm (10")
35 cm (14")	27.5 cm (11")
37.5 cm (15")	27.5 cm (11")
40 cm (16")	30 cm (12")
42.5 cm (17")	32.5 cm (13")
45 cm (18")	35 cm (14")
47.5 cm (19")	37 cm (14")
50 cm (20")	37.5 cm (15")
52.5 cm (21")	40 cm (16")
55 cm (22")	42.5 cm (17")
57.5 cm (23")	42.5 cm (17")
60 cm (24")	45 cm (18")
62.5 cm (25")	47.5 cm (19")
65 cm (26")	50 cm (20")
67.5 cm (27")	50 cm (20")
70 cm (28")	52.5 cm (21")
72.5 cm (29")	55 cm (22")
75 cm (30")	57.5 cm (23")
77.5 cm (31")	57.5 cm (23")
80 cm (32")	60 cm (24")
82.5 cm (33")	62.5 cm (25")
85 cm (34")	65 cm (26")
87.5 cm (35")	65 cm (26")
90 cm (36")	67.5 cm (27")

The background is a solid yellow color. It features several faint, large-scale logos of the Canadian Kennel Club (CKC) and stylized maple leaves. The CKC logo consists of a shield with a dog's head, a banner with the word 'INCORPORATED', and the text 'FOUNDED 1888 FONDE' below it. The maple leaves are large and detailed, with prominent veins.

THE CANADIAN KENNEL CLUB

200 Ronson Drive, Suite 400
Etobicoke, Ontario
M9W 5Z9

Telephone (416) 675-5511

Fax (416) 675-6506

E-mail: information@ckc.ca

Web Site: www.ckc.ca