

BULL DOLLY

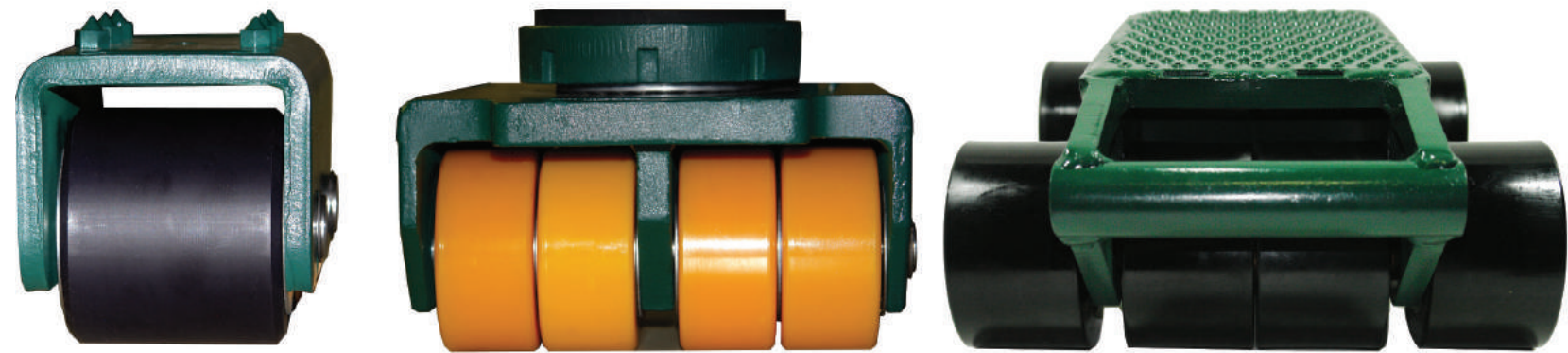

BULL DOLLY

The Hilman Bull Dolly Series are a lightweight, cost effective solution for moving heavy equipment such as large safes, chillers, condensers and other machinery.

1-6 TONS



Lightweight, Cost Effective- Offers different wheel options to protect floors and a variety of top styles for straight moving or turning.

9-18 TONS



Higher Capacity, Large Foot-print - allows user to spread the load over greater area up to 18 tons!

4-72 TON KITS



Prepackaged Kits - come equipped with everything needed to move heavy equipment with ease!



FLOOR PROTECTION

Polyurethane and Nylon wheel options are non-marking and can be used on a variety of floor surfaces.

MAINTENANCE FRIENDLY

Our dollies have very few moving parts minimizing maintenance requirements.

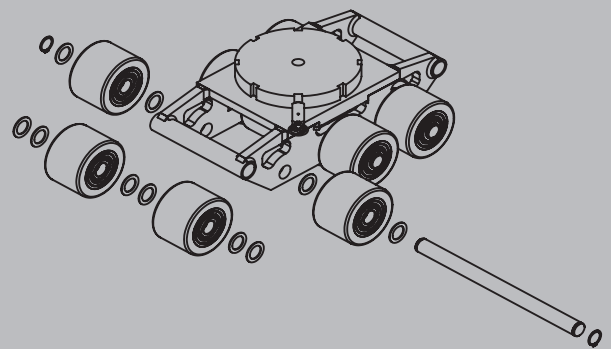

EASY TO MANEUVER

Bull Dollies are ideal for positioning and moving heavy loads either in a straight line or where turns are needed.

ADVANTAGES

Choose Rigid for straight or Swivel for easy turning.

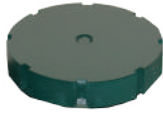

SMOOTH STEEL TOPS (S)
ideal for weld-mounting the rollers to equipment or as a base unit for a variety of top modifications.



PADDED STEEL TOPS (P)
allow some compression and provide a non-slip surface for moving on less than perfect floors.

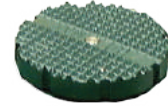

DIAMOND STEEL TOP (D)
spike-like steel grid able to grip into wood and provide a secure move for crated or palletized equipment.

VERSATILE TOP PLATES



LOW PROFILE

LOCK
enables the units to be used as swivel or rigid top dollies

WHEEL OPTIONS

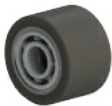

NYLON WHEELS
for good floor protection and favorable wear. They will not "set" if left under load (static) for a period of time

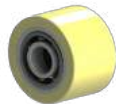

POLY WHEELS
are a softer wheel that provide excellent floor protection on tile floors



STEEL WHEELS
provide the best wear characteristics and are great for durable floors

MAINTENANCE FRIENDLY
wheel & axle design has very few moving parts for easy maintenance

LARGER FOOTPRINT
to spread the load over greater area



MULTI-FUNCTIONAL HANDLE
for pulling

HANDLE & ALIGNMENT BAR
larger models have a handle for pulling or you can use a standard 1 inch alignment bar to stabilize heavy loads or connect multiple dollies



KITS

Lightweight, Cost Effective – easy to maneuver heavy equipment such as large safes, chillers, condensers and machinery.

KBSP-24P

KBSS-12S

KBSD-4N



Product Number	Kit Capacity	Dolly Capacity	Top Style Description	Roller Material	Kits Include	Weight	
						lbs.	kgs.
KBRD-4N	4 ton	1 ton	Rigid Diamond	Nylon	(4) BRD-1N Dollies, (2) Handles, (4) Pre-load pads	75	34
KBRD-4P	4 ton	1 ton	Rigid Diamond	Polyurethane	(4) BRD-1P Dollies, (2) Handles, (4) Pre-load pads	75	34
KBRD-4S	4 ton	1 ton	Rigid Diamond	Steel	(4) BRD-1S Dollies, (2) Handles, (4) Pre-load pads	75	34
KBSP-4N	4 ton	1 ton	Swivel Padded	Nylon	(4) BSP-1N Dollies, (2) Handles	85	39
KBSP-4P	4 ton	1 ton	Swivel Padded	Polyurethane	(4) BSP-1P Dollies, (2) Handles	85	39
KBSP-4S	4 ton	1 ton	Swivel Padded	Steel	(4) BSP-1S Dollies, (2) Handles	85	39
KBSD-4N	4 ton	1 ton	Swivel Diamond	Nylon	(4) BSD-1N Dollies, (2) Handles, (4) Pre-load pads	83	38
KBSD-4P	4 ton	1 ton	Swivel Diamond	Polyurethane	(4) BSD-1P Dollies, (2) Handles, (4) Pre-load pads	83	38
KBSD-4S	4 ton	1 ton	Swivel Diamond	Steel	(4) BSD-1S Dollies, (2) Handles, (4) Pre-load pads	83	38
KBRD-12N	12 ton	3 ton	Rigid Diamond	Nylon	(4) BRD-3N Dollies, (2) Handles, (4) Pre-load pads	91	41
KBRD-12P	12 ton	3 ton	Rigid Diamond	Polyurethane	(4) BRD-3P Dollies, (2) Handles, (4) Pre-load pad	91	41
KBRD-12S	12 ton	3 ton	Rigid Diamond	Steel	(4) BRD-3S Dollies, (2) Handles, (4) Pre-load pads	91	41
KBSP-12N	12 ton	3 ton	Swivel Padded	Nylon	(4) BSP-3N Dollies, (2) Handles	100	45
KBSP-12P	12 ton	3 ton	Swivel Padded	Polyurethane	(4) BSP-3P Dollies, (2) Handles	100	45
KBSP-12S	12 ton	3 ton	Swivel Padded	Steel	(4) BSP-3S Dollies, (2) Handles	100	45
KBSD-12N	12 ton	3 ton	Swivel Diamond	Nylon	(4) BSD-3N Dollies, (2) Handles, (4) Pre-load pads	102	46
KBSD-12P	12 ton	3 ton	Swivel Diamond	Polyurethane	(4) BSD-3P Dollies, (2) Handles, (4) Pre-load pads	102	46
KBSD-12S	12 ton	3 ton	Swivel Diamond	Steel	(4) BSD-3S Dollies, (2) Handles, (4) Pre-load pads	102	46
KBSS-12N	12 ton	3 ton	Swivel Smooth	Nylon	(4) BSS-3N Dollies, (2) Handles	102	46
KBSS-12P	12 ton	3 ton	Swivel Smooth	Polyurethane	(4) BSS-3P Dollies, (2) Handles	102	46
KBSS-12S	12 ton	3 ton	Swivel Smooth	Steel	(4) BSS-3S Dollies, (2) Handles	102	46
KBRD-24N	24 ton	6 ton	Rigid Diamond	Nylon	(4) BRD-6N Dollies, (2) Handles, (4) Pre-load pads	196	89
KBRD-24P	24 ton	6 ton	Rigid Diamond	Polyurethane	(4) BRD-6P Dollies, (2) Handles, (4) Pre-load pads	196	89
KBRD-24S	24 ton	6 ton	Rigid Diamond	Steel	(4) BRD-6S Dollies, (2) Handles, (4) Pre-load pads	196	89
KBSP-24N	24 ton	6 ton	Swivel Padded	Nylon	(4) BSP-6N Dollies, (2) Handles	216	98
KBSP-24P	24 ton	6 ton	Swivel Padded	Polyurethane	(4) BSP-6P Dollies, (2) Handles	216	98
KBSP-24S	24 ton	6 ton	Swivel Padded	Steel	(4) BSP-6S Dollies, (2) Handles	216	98
KBSD-24N	24 ton	6 ton	Swivel Diamond	Nylon	(4) BSD-6N Dollies, (2) Handles, (4) Pre-load pads	216	98
KBSD-24P	24 ton	6 ton	Swivel Diamond	Polyurethane	(4) BSD-6P Dollies, (2) Handles, (4) Pre-load pads	216	98
KBSD-24S	24 ton	6 ton	Swivel Diamond	Steel	(4) BSD-6S Dollies, (2) Handles, (4) Pre-load pads	216	98
KBSS-24N	24 ton	6 ton	Swivel Smooth	Nylon	(4) BSS-6N Dollies, (2) Handles	213	97
KBSS-24P	24 ton	6 ton	Swivel Smooth	Polyurethane	(4) BSS-6P Dollies, (2) Handles	213	97
KBSS-24S	24 ton	6 ton	Swivel Smooth	Steel	(4) BSS-6S Dollies, (2) Handles	213	97

INDIVIDUAL

Bull Dollies are ideal for positioning and moving heavy loads either in a straight line or where turns are needed.

Offers different wheel options to protect floors and a variety of top styles for straight moving (Rigid) or turning (Swivel).

Rigid Diamond



Product Number	Roller Capacity	Top Style Description	Roller Material	Height		Width		Length		Weight	
				inches	mm	inches	mm	inches	mm	lbs.	kg
BRD-1N	1 ton	Rigid Diamond	Nylon	4	102	4.43	113	6.5	165	9	4
BRD-1P	1 ton	Rigid Diamond	Polyurethane	4	102	4.43	113	6.5	165	9	4
BRD-1S	1 ton	Rigid Diamond	Steel	4	102	4.43	113	6.5	165	9	4
BRD-3N	3 ton	Rigid Diamond	Nylon	4.36	111	5.23	133	8	203	13	6
BRD-3P	3 ton	Rigid Diamond	Polyurethane	4.36	111	5.23	133	8	203	13	6
BRD-3S	3 ton	Rigid Diamond	Steel	4.36	111	5.23	133	8	203	13	6
BRD-6N	6 ton	Rigid Diamond	Nylon	4.45	113	10	254	11	279	34	15
BRD-6P	6 ton	Rigid Diamond	Polyurethane	4.45	113	10	254	11	279	34	15
BRD-6S	6 ton	Rigid Diamond	Steel	4.45	113	10	254	11	279	34	15

Swivel Diamond



BSD-1N	1 ton	Swivel Diamond	Nylon	4.43	113	4.43	113	6.5	165	11	5
BSD-1P	1 ton	Swivel Diamond	Polyurethane	4.43	113	4.43	113	6.5	165	11	5
BSD-1S	1 ton	Swivel Diamond	Steel	4.43	113	4.43	113	6.5	165	11	5
BSD-3N	3 ton	Swivel Diamond	Nylon	4.79	122	5.23	133	8	203	16	7
BSD-3P	3 ton	Swivel Diamond	Polyurethane	4.79	122	5.23	133	8	203	16	7
BSD-3S	3 ton	Swivel Diamond	Steel	4.79	122	5.23	133	8	203	16	7
BSD-6N	6 ton	Swivel Diamond	Nylon	5.1	129	10	254	11	279	39	18
BSD-6P	6 ton	Swivel Diamond	Polyurethane	5.1	129	10	254	11	279	39	18
BSD-6S	6 ton	Swivel Diamond	Steel	5.1	129	10	254	11	279	39	18

Swivel Padded



BSP-1N	1 ton	Swivel Padded	Nylon	4.99	127	4.43	113	6.5	165	12	5
BSP-1P	1 ton	Swivel Padded	Polyurethane	4.99	127	4.43	113	6.5	165	12	5
BSP-1S	1 ton	Swivel Padded	Steel	4.99	127	4.43	113	6.5	165	12	5
BSP-3N	3 ton	Swivel Padded	Nylon	5.35	136	5.23	133	8	203	15	7
BSP-3P	3 ton	Swivel Padded	Polyurethane	5.35	136	5.23	133	8	203	15	7
BSP-3S	3 ton	Swivel Padded	Steel	5.35	136	5.23	133	8	203	15	7
BSP-6N	6 ton	Swivel Padded	Nylon	6.6	142	10	254	11	279	39	18
BSP-6P	6 ton	Swivel Padded	Polyurethane	6.6	142	10	254	11	279	39	18
BSP-6S	6 ton	Swivel Padded	Steel	6.6	142	10	254	11	279	39	18

Swivel Smooth



BSS-3N	3 ton	Swivel Smooth	Nylon	4.79	122	5.23	133	8	203	16	7
BSS-3P	3 ton	Swivel Smooth	Polyurethane	4.79	122	5.23	133	8	203	16	7
BSS-3S	3 ton	Swivel Smooth	Steel	4.79	122	5.23	133	8	203	16	7
BSS-6N	6 ton	Swivel Smooth	Nylon	4.85	123	10	254	11	279	38	17
BSS-6P	6 ton	Swivel Smooth	Polyurethane	4.85	123	10	254	11	279	38	17
BSS-6S	6 ton	Swivel Smooth	Steel	4.85	123	10	254	11	279	38	17

Note: All Swivel Top Styles Include Locks

HIGH CAPACITY

9, 12 and 18 ton models have a larger footprint to spread the weight of the load over greater area. Our larger dollies also feature a multi-functional carrying handle that can not only be used to position the unit, but can also fit an optional standard 1 inch alignment bar to stabilize heavy loads.

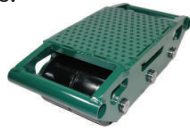

INDIVIDUAL

Product Number	Roller Capacity	Top Style Description	Roller Material	Height		Width		Length		Weight	
				inches	mm	inches	mm	inches	mm	lbs.	kg
BRD-9P	9 ton	Rigid Diamond	Polyurethane	5.63	143	8.125	206	18.32	465	111	50
BSS-9P	9 ton	Swivel Smooth	Polyurethane	6.86	174	8.125	206	18.32	465	119	53
BSP-9P	9 ton	Swivel Padded	Polyurethane	7.86	199	8.125	206	18.32	465	120	54
BSD-9P	9 ton	Swivel Diamond	Polyurethane	6.98	177	8.125	206	18.32	465	119	53
BRD-12P	12 ton	Rigid Diamond	Polyurethane	5.63	143	8.125	206	18.32	465	122	55
BSS-12P	12 ton	Swivel Smooth	Polyurethane	6.86	174	8.125	206	18.32	465	130	58
BSP-12P	12 ton	Swivel Padded	Polyurethane	7.86	199	8.125	206	18.32	465	131	59
BSD-12P	12 ton	Swivel Diamond	Polyurethane	6.98	177	8.125	206	18.32	465	127	57
BRD-18P	18 ton	Rigid Diamond	Polyurethane	5.63	143	8.125	206	18.32	465	146	66
BSS-18P	18 ton	Swivel Smooth	Polyurethane	6.86	174	8.125	206	18.32	465	153	69
BSP-18P	18 ton	Swivel Padded	Polyurethane	7.86	199	8.125	206	18.32	465	155	70
BSD-18P	18 ton	Swivel Diamond	Polyurethane	6.98	177	8.125	206	18.32	465	146	66
BRD-9N	9 ton	Rigid Diamond	Nylon	5.63	143	8.125	206	18.32	465	111	50
BSS-9N	9 ton	Swivel Smooth	Nylon	6.86	174	8.125	206	18.32	465	119	53
BSP-9N	9 ton	Swivel Padded	Nylon	7.86	199	8.125	206	18.32	465	114	51
BSD-9N	9 ton	Swivel Diamond	Nylon	6.98	177	8.125	206	18.32	465	110	49
BRD-12N	12 ton	Rigid Diamond	Nylon	5.63	143	8.125	206	18.32	465	122	55
BSS-12N	12 ton	Swivel Smooth	Nylon	6.86	174	8.125	206	18.32	465	130	58
BSP-12N	12 ton	Swivel Padded	Nylon	7.86	199	8.125	206	18.32	465	119	53
BSD-12N	12 ton	Swivel Diamond	Nylon	6.98	177	8.125	206	18.32	465	115	52
BRD-18N	18 ton	Rigid Diamond	Nylon	5.63	143	8.125	206	18.32	465	146	66
BSS-18N	18 ton	Swivel Smooth	Nylon	6.86	174	8.125	206	18.32	465	153	69
BSP-18N	18 ton	Swivel Padded	Nylon	7.86	199	8.125	206	18.32	465	132	59
BSD-18N	18 ton	Swivel Diamond	Nylon	6.98	177	8.125	206	18.32	465	128	58



SETS

Product Number	Set Capacity	Dolly Capacity	Top Style Description	Roller Material	Set Includes	Weight lbs. kg
RS-BSP-36P	36 ton	9 ton	Swivel Padded	Polyurethane	(4) BSP-9P Dollies, (2) Handles	409 181
RS-BSP-48P	48 ton	12 ton	Swivel Padded	Polyurethane	(4) BSP-12P Dollies, (2) Handles	443 200
RS-BSP-72P	72 ton	18 ton	Swivel Padded	Polyurethane	(4) BSP-18P Dollies, (2) Handles	517 234
RS-BSD-36P	36 ton	9 ton	Swivel Diamond	Polyurethane	(4) BSD-9P Dollies, (2) Handles	401 181
RS-BSD-48P	48 ton	12 ton	Swivel Diamond	Polyurethane	(4) BSD-12P Dollies, (2) Handles	435 197
RS-BSD-72P	72 ton	18 ton	Swivel Diamond	Polyurethane	(4) BSD-18P Dollies, (2) Handles	509 230
RS-BSP-36N	36 ton	9 ton	Swivel Padded	Nylon	(4) BSP-9N Dollies, (2) Handles	372 168
RS-BSP-48N	48 ton	12 ton	Swivel Padded	Nylon	(4) BSP-12N Dollies, (2) Handles	395 179
RS-BSP-72N	72 ton	18 ton	Swivel Padded	Nylon	(4) BSP-18N Dollies, (2) Handles	445 201
RS-BSD-36N	36 ton	9 ton	Swivel Diamond	Nylon	(4) BSD-9N Dollies, (2) Handles	364 165
RS-BSD-48N	48 ton	12 ton	Swivel Diamond	Nylon	(4) BSD-12N Dollies, (2) Handles	386 175
RS-BSD-72N	72 ton	18 ton	Swivel Diamond	Nylon	(4) BSD-18N Dollies, (2) Handles	436 197

MODIFIED

Bull Dollies can be modified in a number of ways to meet specific project needs. From frame size to wheel elevation, Hilman can make a complete solution for you.

WIPERS & BRUSHES



FRAMES & HOLE PATTERNS

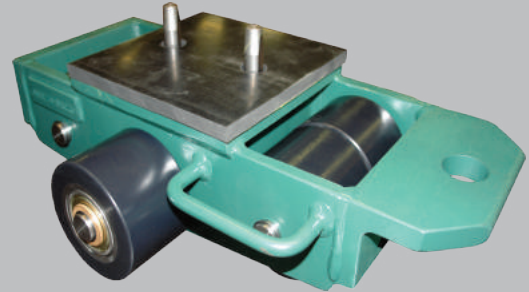

ACCU-ROLL GUIDANCE



HYDRAULIC CYLINDERS



SPECIAL TOPS



ROCKER TOPS

