

# The Business Capability Map:

## The “Rosetta Stone” of Business/IT Alignment

by William Ulrich, Senior Consultant,  
Cutter Consortium; and Michael Rosen,  
Director, Enterprise Architecture Practice

Business architecture, in general, and capability mapping, in particular, have injected clarity into the complex business/IT transformation puzzle. The business capability provides the link between two complex, yet disparate, environments: business architecture and IT architecture. This *Executive Report* discusses how capability mapping enables business analysis and business/IT architecture alignment. Among the topics discussed are capability mapping, IT architecture transformation, the use of capabilities to specify service-oriented architecture (SOA), and the transformation of core IT architectures.

# Report

Executive

MAY 6, 2015 WORKSHOP

# Business Architecture: A Practical Workshop for Novices & Journeymen



Explore a robust, integrated and tested approach that businesses are using to deliver business-wide benefits.

Are you tired of theories, hype and piecemeal approaches to business architecture? This **Cutter Summit 2015** workshop with Cutter Senior Consultant William Ulrich will show you how today's business architecture incorporates a widely agreed upon foundation, formal framework and best practices that are spreading organically across a myriad of industries.

This half-day workshop is collocated with **Summit 2015 in Cambridge, MA, and runs 9am - 1pm on May 6**. You'll explore a robust, integrated and tested approach that businesses are using in practice to deliver enterprise-wide benefits. Workshop Outline:

- Introducing Business Architecture: Delivering Transparency to the Business Ecosystem
- Understanding the Business Architecture Value Proposition: A Strategic Perspective
- Building the Core: Capability, Value, Information & Organization Mapping
- Moving from Strategy through Execution: Strategy, Initiative, Stakeholder, Policy & Product Mapping
- Aligning Related Business Disciplines: Case Management, BPM & Business Requirements Analysis
- Business Architecture & IT Architecture: Transformation Definition and Solution Deployment
- Governance, Sponsorship & Getting Started: Key Takeaways

**Register Today!**

## **Business Architecture: A Practical Workshop for Novices & Journeymen**

May 6, 2015 (collocated with Cutter Summit 2015, 4-6 May 2015)

Le Méridien Hotel, Cambridge, MA, USA

Register now at [www.cutter.com/summit.html](http://www.cutter.com/summit.html) or call **+1 781 648 8700** (team discounts available). Register for the half-day workshop alone for \$695 or the entire three-day Summit for \$2495. Don't miss your chance to gain advice and recommendations from Cutter thought leaders who are ready to help you untangle your trickiest business technology problems.

# Access to the Experts

Cutter Consortium is a unique IT advisory firm, comprising a group of more than 100 internationally recognized experts who have come together to offer content, consulting, and training to our clients. These experts are committed to delivering top-level, critical, and objective advice. They have done, and are doing, groundbreaking work in organizations worldwide, helping companies deal with issues in the core areas of software development and agile project management, enterprise architecture, business technology trends and strategies, innovation, enterprise risk management, metrics, and sourcing.

Cutter offers a different value proposition than other IT research firms: We give you *Access to the Experts*. You get practitioners' points of view, derived from hands-on experience with the same critical issues you are facing, not the perspective of a desk-bound analyst who can only make predictions and observations on what's happening in the marketplace. With Cutter Consortium, you get the best practices and lessons learned from the world's leading experts — experts who are implementing these techniques at companies like yours right now.

Cutter's clients are able to tap into its expertise in a variety of formats, including print and online advisory services and journals, mentoring, workshops, training, and consulting. And by customizing our information products, training, and consulting services, you get the solutions you need while staying within your budget.

Cutter Consortium's philosophy is that there is no single right solution for all enterprises, or all departments within one enterprise, or even all projects within a department. Cutter believes that the complexity of the business technology issues confronting corporations today demands multiple detailed perspectives from which a company can view its opportunities and risks in order to make the right strategic and tactical decisions. The simplistic pronouncements other analyst firms make do not take into account the unique situation of each organization. This is another reason to present the several sides to each issue: to enable clients to determine the course of action that best fits their unique situation.

## Expert Consultants

Cutter Consortium products and services are provided by the top thinkers in IT today — a distinguished group of internationally recognized experts committed to providing top-level, critical, objective advice. They create all the written deliverables and perform all the consulting. That's why we say Cutter Consortium gives you *Access to the Experts*.

**For more information, contact Cutter Consortium at +1 781 648 8700 or [sales@cutter.com](mailto:sales@cutter.com).**

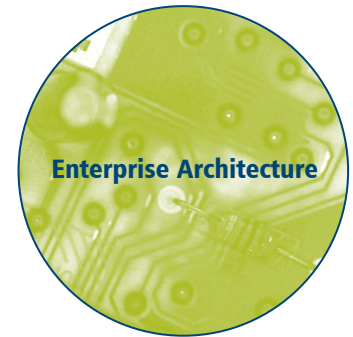

*The Enterprise Architecture Advisory Service Executive Report is published by the Cutter Consortium, 37 Broadway, Suite 1, Arlington, MA 02474-5552, USA. Client Services: Tel: +1 781 641 9876; Fax: +1 781 648 8707; E-mail: [service@cutter.com](mailto:service@cutter.com); Web site: [www.cutter.com](http://www.cutter.com). Group Publisher: Kara Letourneau, E-mail: [kletourneau@cutter.com](mailto:kletourneau@cutter.com). Managing Editor: Cindy Swain, E-mail: [cswain@cutter.com](mailto:cswain@cutter.com). Print ISSN: 1554-7108 (Executive Report, Executive Summary, and Executive Update); online/electronic ISSN: 1554-7116.*

*©2011 Cutter Consortium. All rights reserved. Unauthorized reproduction in any form, including photocopying, downloading electronic copies, posting on the Internet, image scanning, and faxing is against the law. Reprints make an excellent training tool. For more information about reprints and/or back issues of Cutter Consortium publications, call +1 781 648 8700 or e-mail [service@cutter.com](mailto:service@cutter.com).*



Rob Austin



Ron Blitstein



Christine Davis



Tom DeMarco



Lynne Ellyn



Tim Lister



Lou Mazzucchelli



Ken Orr



Robert Scott

# The Business Capability Map:

## The “Rosetta Stone” of Business/IT Alignment

### THIS MONTH’S AUTHORS



**William Ulrich**  
Senior Consultant, Cutter Consortium



**Michael Rosen**  
Director, Cutter Enterprise  
Architecture Practice

Over the past several years, the business capability has moved to the front and center of business analysis and planning. As a view of a business, the robustness and versatility of the business capability has boosted its use within business planning teams, executive steering committees, business architecture teams, and business/IT transformation initiatives. This *Executive Report* discusses why the business capability has emerged as the “Rosetta Stone” for business communication and collaboration and, more specifically, business/IT alignment (see sidebar). As a key aspect of business transformation efforts, the business capability serves as an essential communication medium between a business and an organization’s ability to transform itself through the use of IT.

### IN THIS ISSUE

- 2 The Basics: What Is a Business Capability and Why Use It?
- 5 Mapping Business Capabilities
- 14 Role of Capabilities in Business/IT Transformation Planning
- 22 Conclusion
- 22 Endnotes
- 23 About the Authors

The report focuses on the use of the business capability as the lynchpin communications vehicle for business/IT transformation planning as well as providing a vocabulary for business to communicate and collaborate with IT architecture and IT solution delivery teams. While the report focuses on the business capability as the missing link in business-to-business and business-to-IT communications, we incorporate additional familiar concepts into the discussion, including value streams, business processes, and information assets from a business perspective, and application and information architecture from an IT perspective.

Collectively, these business and IT architecture representations provide views of the business/IT ecosystem that enable both business and IT professionals to communicate and collaborate on equal footing. With these representations as the backdrop, this report provides a building block approach to business capabilities, discusses how capabilities relate to the business architecture as a whole, and offers an approach for using capabilities as a basis for planning and executing a business/IT transformation program.

## THE BASICS: WHAT IS A BUSINESS CAPABILITY AND WHY USE IT?

We start with the basics, which includes defining the business capability and its role in business analysis and business/IT transformation.

### Defining the Business Capability

A business capability, or simply a “capability,” defines *what* a business does. It does not communicate or expose *where, why, or how* something is done — only what is done. Specifically, the business capability is “a particular ability or capacity that a business may possess or exchange to achieve a specific purpose or outcome.”<sup>1</sup> This is the standard definition for a capability and has been in common use for the past several years in the business architecture community.

Understanding what a business does is just as important as understanding “how” something is being done.

### DECRYPTING THE “ROSETTA STONE”

The Rosetta Stone, originally created in 196 BC, was inscribed with an ancient decree written in three languages: ancient Egyptian hieroglyphics, Egyptian demotic script, and ancient Greek. Because the same text was written in three languages, both well understood and poorly understood, it became a critical artifact in civilization’s ability to understand ancient Egyptian hieroglyphics. The Rosetta Stone has since become an idiom for any type of key useful for decrypting encoded information between well-understood and poorly understood communication mediums. (Taken from [www.ancientegypt.co.uk/writing/rosetta.html](http://www.ancientegypt.co.uk/writing/rosetta.html).)

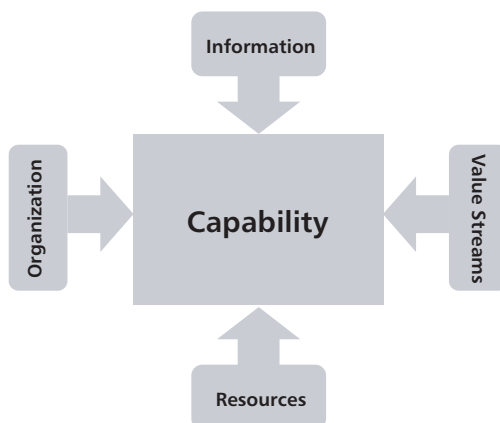

©TSA, Inc.

Figure 1 — Capabilities relate to other aspects of a business.

Focusing on what a business does provides a method to analyze complex business environments in ways that can be readily digested by executives and planning teams. Viewing a business as a set of basic capabilities opens the door to being able to visualize business ecosystems in a wide variety of ways while not obfuscating the message. More detail is available by zooming in on lower levels within a given capability.

Consider the example of the high-level business capability called “customer management.” This business capability is common to most businesses. A government may use the term “constituent” or “stakeholder,” or a hospital may use the term “patient,” but the concept remains the same. Customers are external stakeholders to which a business delivers products and/or services in exchange for monetary (or nonmonetary) value. Most businesses have the ability to manage the various aspects of a customer. Customer management is considered a Level 1 capability. Level 2 capabilities within customer management may include customer information management or customer trend analysis.

Capabilities can be decomposed, typically from Levels 1-3 for purposes of planning and Levels 4-6 for purposes of detailed business/IT mapping. Therefore, when viewing a capability, it is important to remember that you are always viewing what is being done and not the related aspects of the business on which one or more capabilities depend.

Deconstructing a given business capability, which is an abstraction of the business itself, provides a better sense as to how capabilities fit in the overall view of the business. Figure 1 provides an external view of a capability by highlighting the fact that a business capability is related to the business in many ways. For example, a customer information management capability would naturally rely on customer information. In addition, various organization units have certain capabilities related to customer management.

Organizational mapping is particularly important. Consider that retail banking, mutual fund management, and investment management lines of business (LOBs) all have customer information management capabilities. Establishing a common view of customer and a common way to manage the customer requires these LOBs to collaborate and consolidate their thinking. This is not a task that can, or should, be left up to IT. Because it is a business decision, it requires the business to take action.

Resources are a general category that includes technologies, funding, and other assets as appropriate. Funding is of particular interest to many executive teams when it

comes to improving or enabling a given business capability. The technologies portion of the resource category can include a wide range of information technologies that enable or automate a given capability. We will discuss the specifics of application architecture, including service-oriented architecture (SOA), within the context of business/IT alignment.

Value streams, a key component of the business ecosystem, may take a little more explanation. Value streams depict *how* a business achieves value for an internal or external stakeholder. They are defined as an end-to-end collection of activities that create a result for a customer.<sup>2</sup> Value streams are a very high-level view of value accretion, broken into stages. Value stream stages further decompose into business processes, which typically define the details below various stages of a given value stream. We will discuss this concept later in the report. The important point to remember is that the business capability has relationships to other aspects of the business and the IT architecture.

One more important point is that Figure 1 does not imply that a capability contains or somehow encompasses or subsumes organization units, information, resources, or value streams. This common misperception has resulted in a degree of confusion with capability mapping. Relationships between the capability and other aspects of the business or IT architecture are just that — relationships. It is the power of these relationships that provides the visibility required to assess the root cause of a given issue and determine the overall impact of what it will take to address that particular issue.

Relationships to any given capability can number in the hundreds when traced across business units, technologies, processes, and information assets. But these complexities can remain out of view unless a particular initiative or a planning team requires drilling down into more detail. For example, if procurement management is poorly deployed and costing the company much more than it should, management would want to get to the specific lower-level capability causing the problem. In this example, a vendor information management capability may be found to be scattered across dozens of business units. Additional drill-down analysis determines that a value stream called “procure resources” is implemented via dozens of parallel, yet uncoordinated processes, each of which rely on their own disparate software systems and tracking databases. In this case, the capability was the lynchpin to identifying the business units and related suppliers, processes, and supporting technologies that require attention. Note that this research could be done informally, but the business

capability and related business abstractions provide a vocabulary, analytical discipline, and formal mapping structure that can be institutionalized for countless similar challenges that emerge on a regular basis in organizations. This further demonstrates the power of the business capability in various stages of business/IT alignment planning, and deployment.

## Basic Capability Principles

Understanding, using, and representing a set of business capabilities for a business is challenging for many management teams. Establishing certain principles (“agreed-upon truths to guide our actions”) streamlines efforts to understand, explain, define, map, and use capabilities for planning and executing business/IT transformation efforts. These 10 principles are:

1. **Capabilities define what a business does, not how a business does something.** Resist temptation to mix these concepts because it will destabilize the use of business capabilities downstream. This is the number one test to determine if a capability is actually a capability and not a value stream or a process.
2. **Capabilities are nouns, not verbs.** The passive approach to specifying a capability (e.g., investment management) reflects one of the differences between the capability and a value stream or business process — where an active verb/noun construct is used (e.g., issue license). This principle helps reinforce Principle 1.
3. **Capabilities are defined in business terms, not technical terms.** Business professionals, from the front lines to the executive suite, should be able to look at one or more capabilities and immediately understand what they mean in terms of their unique business environment. Just because an application automates a capability is no reason to put a technical spin on the name and replicate it in the capability map. (Capability mapping will be introduced in a later section.)
4. **Capabilities are stable, not volatile.** There is a fundamental set of capabilities that are required for a particular organization to conduct business. These capabilities rarely change within an organization, although there are many capabilities that are deployed in suboptimal ways. For example, management may argue that customers have the ability to manage a portfolio of products or services, but doing so may be cumbersome and lack basic automation and reconciliation abilities. The capability still exists but is considered to be weakly deployed. These capabilities should still be defined

so they can be considered in planning activities. Adding a new capability occurs, but this is generally not done at the highest level unless there is an executive-level change to the business model or business strategy. For example, if a company that sells its products to other manufacturing companies moves into the retail business, new capabilities to manage the retail business are likely to emerge.

5. **Capabilities are not redundant.** Capabilities show up on a capability map once and only once for a business, regardless of how many business units possess that particular capability, how many business processes deploy it, or how many application systems implement it. For example, claims management would only show up once on a capability map, even though multiple product lines of an insurance business have this capability.
6. **There is one capability map for a business.** Any given business should have one capability map that spans organizational boundaries. Unfortunately, this principle is violated constantly. In one case, we worked with a financial institution that had multiple capability maps — one for each business unit. There was no effective way to view the business in aggregate because each map was a view of the organization from a singular perspective. When this occurs, the ability to bring transparency to the business typically required by strategic initiatives is clouded to the point where these capability maps offer marginal, if any, value outside a given business unit.
7. **Capabilities map to, but are not the same as, an LOB, business unit, business process, or value stream.** An LOB is not a capability. The names may have similarities and LOBs are a useful consideration when building capabilities, but there is rarely a one-to-one correspondence between LOBs and capability. Similarly, when a capability decomposes to a given level, it does not become a process, task, or activity. These are distinct abstractions of the business and mingling them compromises the value they offer in business analysis and transformation planning and deployment. For example, a capability maps succinctly to a business unit, initiative, information asset, and application or service. Mapping processes to these business and IT abstractions, however, creates a muddled view because a given process may cross dozens of business units and IT deployments in extraneous ways that have little to do with the capability under review. A capability does not decompose into a process; a process does not decompose into a capability.

8. **Capabilities have relationships to IT deployments and future-state IT architecture.** Capabilities identify the fundamental functions, activities, and abilities that are required for an enterprise to thrive. Capabilities align directly to SOA implementations. Keep in mind, however, that capabilities may or may not be automated via back-end application architectures, SOA business services, COTS software, or even desktop environments. Capabilities may be entirely manual in nature.
9. **Automated capabilities are still business capabilities — not IT capabilities.** This principle refers to a common trap. IT occasionally introduces the concept of an “IT capability,” which means that it is a business capability implemented in an application. This is not an IT capability; it is an automated business capability. IT as a business unit does, however, have certain capabilities related to provisioning IT infrastructure, building software, and managing operational solutions.
10. **Capabilities are of most value when incorporated into a larger view of an enterprise’s ecosystem.** We will discuss how capabilities fit into the business and IT architecture views in later sections. While useful as a stand-alone planning and discussion paradigm, leveraging capabilities to their fullest potential requires that they be incorporated into the overall picture of the business/IT ecosystem.

These principles are useful in guiding implementation actions for defining, communicating, and leveraging business capabilities in analysis, planning, and transformation exercises. Evaluating transformation analysis and planning against these principles should ensure that your efforts are balanced and are applying best practices, which in turn should keep projects focused and on track.

### Why Capability Is the Missing Link in Business/IT Transformation

The emergence and growing popularity of the business capability is due to a combination of factors that enable business/IT transformations:

- **Capabilities provide business with a common language.** Capabilities offer a way in which business executives can gain a common understanding of which portion of their business they need to address. This is particularly true for business issues and strategies that cross divisional, business unit, or even enterprise boundaries. For example, if the product design capability within product management is somehow

impaired, executives have a common language to discuss the problem, regardless of the division, department, or even outsourced business units in question. Similarly, if customer management requires attention in an enterprise where customers are shared across LOBs and product lines, capability analysis provides a common focal point around which to assess the situation and establish a solution roadmap.

- **Capabilities enable laser-like business investment focus.** An enterprise will spend money to ensure that a given capability is adequately supporting the business. For example, if executives sense that the money management capability is somehow inferior or lacking, they will agree to make an investment in improving that capability. Another view of this same scenario is that your business is already investing significantly in improving money management, but executives cannot articulate exactly how much budget is allocated to these efforts across multiple divisions and business units. Capability-based investment analysis is a growing trend in business circles and enables a focused strategy aimed at improving a given business capability. This type of analysis requires the ability to envision a capability as it “fans out” across a business and related IT architectures, focusing specifically on the areas of impact for the capability at risk.
- **Capabilities serve as a baseline for strategic planning, change management, and impact analysis.** Capabilities provide a business-oriented starting point for any discussion around strategic planning and help determine the impacts of those plans from an enterprise perspective. In our money management example, there are countless processes, information views, and technology resources that enable money management. As a rule, there is little visibility into the impacts of any change driven by a strategy to realign money management based on weaknesses in the current business model or deployment of that model. Capabilities serve as the common starting point, or Rosetta Stone, for tracking the horizontal and vertical impacts of strategic and tactical directives from the executive team.
- **Capabilities lead directly to business service specification and design.** Capabilities represent a business-focused abstraction of the singular functions and information that IT systems must provide — in other words, a fundamental representation of the business requirements. SOA business and information services provide “one way to do one thing” and “one place to get one kind of information” across the entire enterprise. Where better to get the

requirements for what a service must provide but directly from business needs?

Consider the customer management capability. Customer management involves numerous teams, multiple divisions, hundreds of processes and subprocesses, dozens of back-end application systems and databases, and countless desktop systems. Attempting to absorb this wealth of information — assuming it is even available — as an initial step in seeking a resolution to the loss of customers is not only impossible but counterproductive. The limited view from any one perspective leads to Band-Aid solutions, redundant yet poorly coordinated projects, and even more frustration on management’s part.

When a capability map is established and linked to other views of the business and IT architecture, the resulting map becomes extremely powerful in terms of focusing on one or multiple issues. Many times there is no reason to dismantle an entire set of applications. One insurance company we’ve worked with focused its efforts on one low-level capability, and with minimal investment, improved customer retention dramatically in a very short time frame, allowing it to architect and implement a longer-term, SOA-based solution to consolidating customer information.

Using the business capability as the focal point for problem analysis, strategic planning, investment determination, and initiative funding allows management to cut through the complexity inherent in most enterprises. Using capability analysis offers executives, planning teams, and steering committees a way to communicate *what* must be resolved without initially delving into the details of the *how*. At the same time, it allows the *how* to be tied directly to the *what*, formalizing alignment and enabling validation that a given effort is achieving the desired business results.

The alternative to this approach typically involves repeating the same baseline analysis, which usually is done in piecemeal fashion, is highly silo-focused, and tends to focus on IT solutions first instead of as an outgrowth of the business analysis and business strategy. In the absence of capability-based planning and transformation, the challenges facing analysis and planning will continue, redundant and suboptimal solutions will be pursued, and investments will continue to miss the mark in terms of real business value.

## MAPPING BUSINESS CAPABILITIES

Capabilities find a home in the “capability map.” The capability map is simply a blueprint of the capabilities





©TSA, Inc.

Figure 2 — Three-level capability decomposition.

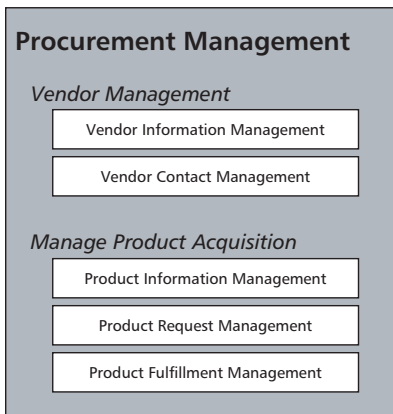

©TSA, Inc.

Figure 3 — Capability decomposition: procurement example (Levels 1-3).

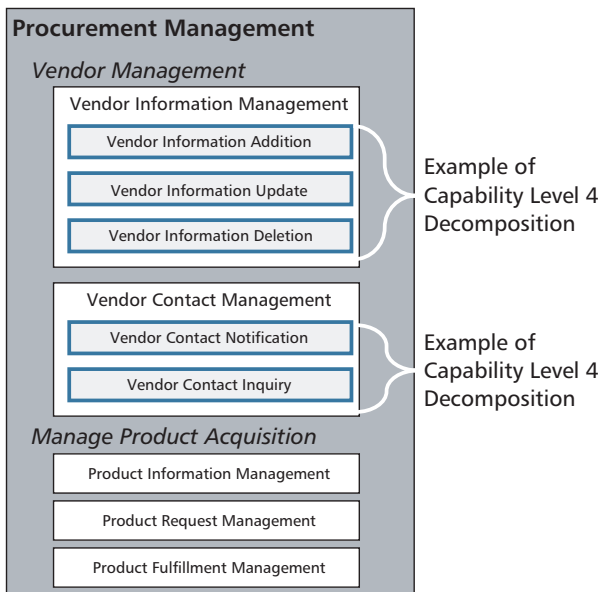

©TSA, Inc.

Figure 4 — Capability decomposition: procurement example (Level 4).

for a given business. The map is a common way for businesses to document and visualize capabilities within the context of various analysis or planning exercises.

### Deconstructing the Business Capability

Building a capability map is an exercise in introspective analysis and decomposition. This begins with understanding how a capability is defined and viewed. Figure 2 shows the common three-level decomposition for a business capability. This decomposition approach, which can go deeper where appropriate to the level of analysis desired, is a standard way of depicting a capability.

Each level in Figure 2 has a name associated with it (i.e., foundation capabilities, capability groups, and business capabilities). While these are useful delineation points, the level is typically used to describe the depth of capability decomposition (e.g., Level 2) in common usage.

The three-level concept can be taken down further, typically going to a maximum of five or six levels. At the sixth level, a capability is very detailed, but this becomes more important when engaging in business/IT architecture mapping. Levels 4-5 capabilities get to a level of granularity that map to deployed business logic, such as SOA business services, within application architectures, or to other automations. For purposes of high-level planning and analysis, capability maps typically do not decompose capabilities below Level 3. Level 3 capabilities can be used as requirements input for high-level IT analysis. Figure 3 depicts an example of a Level 1 capability called “procurement management” that has been decomposed into two Level 2 and multiple Level 3 capabilities.

When decomposing a capability, there should be at least two or more levels, as shown in Figure 3. The procurement example demonstrates how each decomposition level is a refinement of the previous parent level. It also demonstrates how each capability level remains a capability insofar as the term is a noun, not a verb, and still describes what the business does, not how it does it. Figure 4 carries this example one step further by taking the capability decomposition down to a Level 4.

Many organizations using capabilities have only gone down to Level 3. Level 4/5 decomposition is important when a business wants to clearly articulate and align (or not align) specific abilities across business units or LOBs. In addition, a 4/5 decomposition provides the business driver for identifying, reusing, consolidating, and/or deactivating business logic in current-state

applications and defining common services in the future-state IT architecture. The procurement management capability example we have been reviewing is only a single, Level 1 capability. In practice, business architects would create a capability map that represents the business as a whole, including all the Level 1 capabilities and their decompositions.

### Breaking Down the Capability Map

So the capability map is the commonly used business blueprint for depicting a set of capabilities for a business. Note that we use the term “business” as opposed to “enterprise” because a business may extend beyond the bounds of an enterprise. Consider an insurance/financial institution that offers health, life, and disability insurance to customers but actually outsources all life- and disability-related capabilities. Or consider the company that has outsourced HR management, IT management, or procurement management. These are capabilities that are handled by external companies. Therefore, a capability map should be viewed as business-wide and not just enterprise-wide.

Figure 5 depicts an example of a partially completed capability map for Level 1 capabilities. The capability map in Figure 5 is meant to be generic but certainly leans more toward that found within a services organization as opposed to a manufacturing, transportation, or mining/agricultural business. There are several commonalities within this capability map to capability maps for other businesses. For example, the concept of customer management, account management, and product

management are universally accepted concepts but not necessarily applicable to every business.

The layering structure within the capability map example in Figure 5 is a common way for the business to stratify a capability map into groups, with each layer representing a set of capabilities as they relate to the viability of the business and the bottom line. The “strategic” layer includes capabilities that reflect executive priorities. Investment management, for example, falls into this category. What is incorporated into this layer is unique to a given set of executive priorities and related mission. In Figure 5, one strategic capability may stand out as unusual — government relations management. However, in certain transportation or communications industries, this may be a top priority and significant focal point for executives.

The “value-add” tier of the capability map goes to the heart of what an enterprise does to ensure viability and thrive in the marketplace. Customer, product, and account management are major areas that a given enterprise will dedicate significant resources to — although not necessarily in the most effective manner. These customer-facing capabilities are core to a given business and must deliver acceptable levels of value for a given business to continue to thrive. A lack of focus on customer-facing capabilities can often explain why many institutions have such a fragmented, highly redundant, and inconsistent set of practices and supporting technologies for managing customers, accounts, and products.

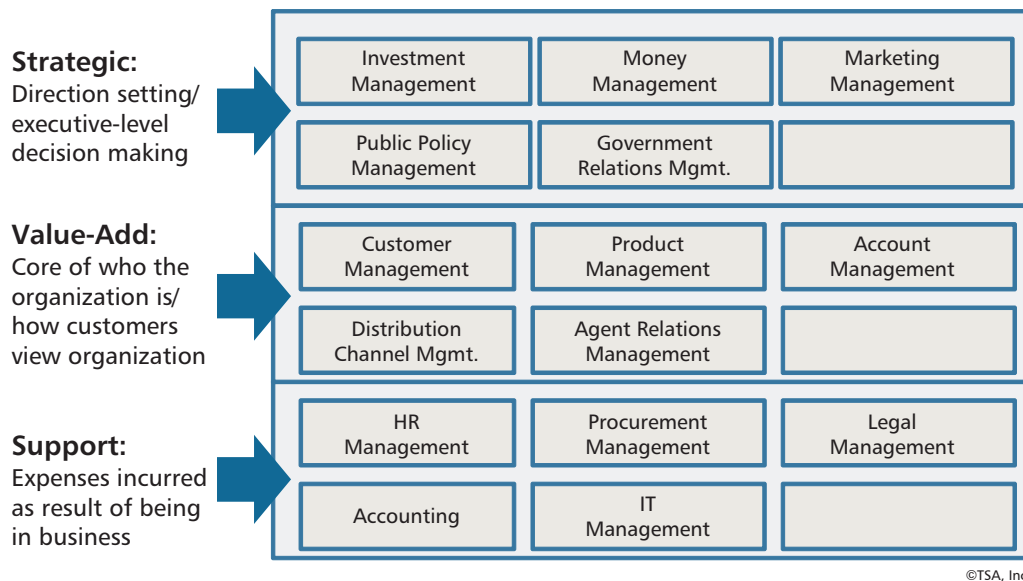

Figure 5 — Sample Level 1 capability map.

Many major multiline insurance and/or financial companies, for example, manage customers in independent silos, using independent business processes and application environments. This can only be ignored by executives until it impacts the bottom line in a way that customers or stockholders take notice. At that point, action must be taken.

Finally, the “support” layer of capabilities represents certain abilities that an organization must have to function as a business. HR, financial management, and legal management are prime examples. These capabilities are also common targets for outsourcing, given that they truly are supporting capabilities.

One interesting example shown in Figure 5 involves procurement management — the capability we decomposed previously in Figures 3 and 4. Procurement at a financial firm, insurance company, or even a government agency is likely a supporting capability, and some of these organizations have outsourced procurement for that very reason. A different industry may look upon procurement with a different focus. Auto manufacturers, for example, would raise procurement management to at least the role of value-add and possibly to the strategic level.

The capability map is the main way in which management and other business professionals view a set of capabilities for an organization. While the map is the main visual used to understand a business via capabilities, it is not the only way in which to visualize capabilities. It is also important to understand that behind the map is a formal representation of capabilities, decomposition relationships, concise definitions for each capability, and mappings to other aspects of the business and IT architecture. The “knowledgebase” concept for enabling these expanded views of capabilities will be discussed later.

## Building the Capability Map

The first rule in building the capability map ties back to one of our core principles: there is one capability map for a business. This means that every business unit within a given enterprise should contribute to and leverage the map. When organizations have multiple maps, one for each division for example, capability-based planning and transformation across business units is almost impossible. Consider if you tried to chart a route across the country using only a collection of city maps to guide you. You would never see the big picture. In addition to not being able to see the big picture, executives that have to assess issues and chart strategies have no common language that they can

use when looking across business units unless a single capability map is applied enterprise-wide. Note that an exception to this may involve multiple agencies within a federal or other large government or truly autonomous divisions within a conglomerate.

The second rule, driven by a combination of Principles 5 and 6, is that “every capability is rationalized into a single occurrence.” For example, there is only one account management capability, even if, for example, this capability represents abilities common to all financial and insurance business divisions within an enterprise. Compromises in naming conventions, a key requirement in creating a capability map, can result in hybrid names, such as account and policy management or policy and contract management. This is fully acceptable as long as all divisional business leaders and inputting managers agree that this is the terminology that should be used.

With these rules as a baseline, we have outlined a series of 10 steps for building and validating a capability map:

- 1. Obtain an industry template if possible.** If there are examples, templates, or consultancy-supplied capability maps that your organization can obtain in advance of starting a mapping effort, these should be incorporated into the analysis process. Keep in mind that templates are only starting points, not ending points.
- 2. Draft an organization-specific Level 1 capability map.** This step involves either refining an acquired template or drafting a baseline map using commonly found capability categories. Inputs to this step include templates from Step 1 (where available), organization models or charts, information asset (e.g., customer, product, account) definitions, and additional high-level business views. Refine or create the initial draft using enterprise-specific inputs and a set of commonly found capabilities that would include the following categories:
  - Customer or equivalent external stakeholder management
  - Product or service management
  - Account, policy, contract, or similar management
  - Additional external stakeholder relations management
  - Investments, marketing, and other strategic management
  - Industry-specific categories, such as claims, routing, or money management

- Support capabilities, including accounting, HR, IT, and legal management
3. **Finalize Level 1 capability map.** This involves holding a facilitated session with senior business representatives from each LOB. The deliverable from this step will be the final draft of a Level 1 capability map. This session includes:
    - Reviewing the initial draft or “straw man” capability map created in Step 2
    - Establishing concise definitions for each capability, specifically the descriptive portion of the capability (e.g., product, account, money, customer)
    - Viewing capabilities and related definitions through an information-related lens (e.g., customer management capability should align with a common definition of “customer”)
    - Rationalizing capability names across LOBs and divisions (e.g., policy versus contract)
    - Ensuring that no capability gaps exist within the final Level 1 map
  4. **Publish the Level 1 capability map.** Many organizations may not be familiar with business capabilities and will need a little bit of time to get used to the concepts. The best way to make this introduction is with the highest-level capabilities. While Level 2/3 decompositions may result in additional Level 1 refinements, publishing the initial version of the map can elicit questions and feedback from the business and present an opportunity to explain the concepts, value, and benefits with key stakeholders. We note here that publishing in this context involves socializing and soliciting additional insights and feedback.
  5. **Establish Level 2 capability decomposition priorities.** This step can be prioritized by executives seeking more information or may move to complete the entirety of the Level 2 capability mappings for the business. One common approach involves leaving supporting capabilities until they are required and focusing on value-add capabilities first because this is the core of a given business model. Strategic capabilities may be decomposed at the directive of a given management initiative or as a subsequent or interdependent step to decomposing value-add capabilities.
  6. **Decompose Level 2 capabilities.** Using the Level 1 capability map as a baseline, decompose selected

Level 1 capabilities (prioritized in Step 5) by working with business line professionals for each category. This entails holding working sessions for each Level 1 capability or set of related capabilities. For example, if claims management is targeted for decomposition, work with business managers from all claims areas to depose the entirety of what is done within a claim. Note that Level 3 capability decomposition may be pursued concurrently but requires validation by business professionals with knowledge of the details below Level 2. If a Level 2/3 decomposition can be accomplished concurrently with the same teams, the process can be completed more efficiently. This step includes:

- Holding facilitated sessions for each level capability targeted for decomposition
  - Ensuring that all LOBs are represented as appropriate to the topic (e.g., health claims, life claims, auto claims, homeowner claims)
  - Leveraging information asset views, although at an additional level of detail than used for capability Level 1 analysis (e.g., customer name, customer address, customer number)
  - Leveraging organization charts and other high-level business
7. **Establish Level 3 capability decomposition priorities.** This step is similar to the Level 2 priority setting step (Step 5). While it is important to establish and document Level 3 capabilities for value-add and strategic capabilities, certain business priorities, strategies, or directives can dictate a focus on a subset of capabilities as a priority. Priority setting should be completed prior to moving forward with Level 3 decomposition.
  8. **Decompose Level 3 capabilities.** This step follows a similar approach to the process of decomposing Level 2 capabilities with the exception of the level of participation. Level 3 decomposition may require another level of business professionals below the management layer that worked on Level 2 decomposition. At a minimum, these professionals will need to review and validate Level 3 capabilities.
  9. **Socialize and refine the capability map.** Each participant at each step of the way should have the opportunity to informally review and provide feedback to the capability map as it evolves. This step, however, involves a formal review and finalization of the work done to this point. At a minimum, the original executive team that worked on the initial

capability map should be reassembled to review and sign off on the final capability map.

**10. Publish the capability map.** Capability maps take a long time to complete in their entirety, and some organizations do not decompose certain Level 1 capabilities until they require them. This is normal and is particularly true for supporting capabilities. Do not wait for all capabilities to be decomposed. Publish the capability map in a location where it can be accessed by anyone who chooses to view it and where the most current version will be available as the map evolves, with the standard internal privacy and security considerations.

Once the initial version of the capability map has been published, capability mapping to additional aspects of the business architecture and IT architecture can move forward.

### Incorporating Capability into Business Architecture

Business architecture is defined as a blueprint of the enterprise that provides a common understanding of the organization and is used to align strategic objectives and tactical demands.<sup>3</sup> Incorporating capabilities into the larger business architecture is important because business-to-business and business-to-IT mappings provide the basis for much of the analysis associated with business/IT transformation. Traditionally, capability maps were detached from other models and structures, and this was not conducive to transformation planning or deployment.

While a number of business-to-business mappings fall under the umbrella of business architecture, we are only focusing on a subset relevant to most business/IT

transformation initiatives. The business-to-business mappings include the following:<sup>4</sup>

- Organization unit decomposes into organization unit.
- Organization unit is a business partner.
- Organization unit has capability (Level 1 or Level 2) depending on level of organization unit.
- Capability Level 1 decomposes into capability Level 2.
- Capability Level 2 decomposes into capability Level 3.
- Capability Level 3 decomposes into capability Levels 4, 5, and 6 as required.
- Capability Level 3 maps to various stages within the value stream.
- Value stream stage decomposes into business process.

We repeated the capability decomposition mapping here because it must be represented within the business architecture knowledge base along with each of the other mapping categories discussed in the above bullets. Organization-unit-to-business-capability mapping is important because it identifies the groups of business communities that have an interest in a given capability. This is where transformation discussions should begin because business/IT transformation requires an understanding of the breadth and depth of the stakeholder community and each stakeholder’s concerns. Any transformation approach will more than likely impact multiple stakeholders. Figure 6 depicts business unit/business capability mapping within the context of a social networking diagram. This business architecture blueprint shows how three business units (i.e., property

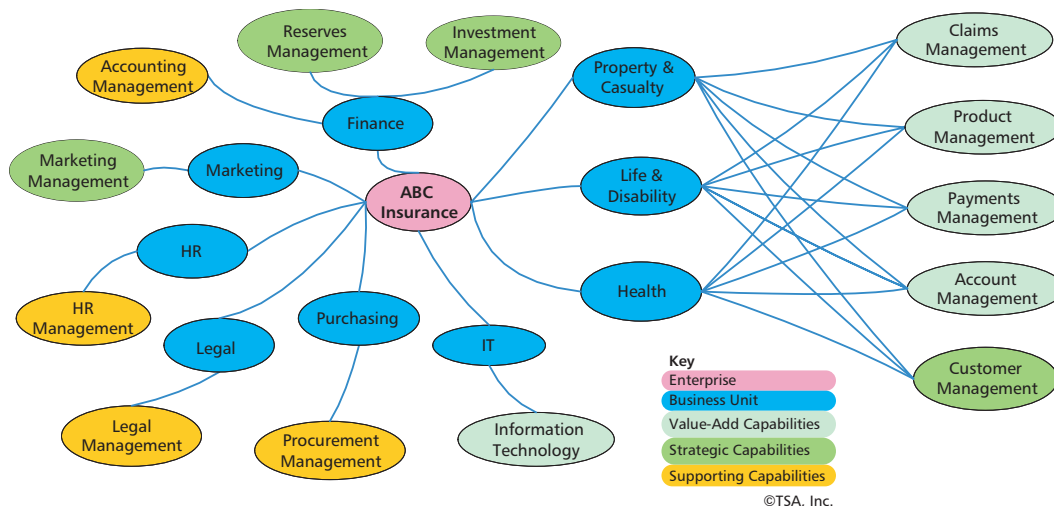

Figure 6 — Organization-unit-to-business-capability mapping.

and casualty, life and disability, and health) share common capabilities: claims, product, payment, account, and customer management (shown to the right of the diagram).

Capability-to-business-unit (i.e., organization) mapping is normally the starting point for a transformation discussion. The reason for starting with capability and business unit is that it is an essential step to identifying horizontally shared capabilities (e.g., customer management) and pinpointing the business areas to focus on first. While this high-level map may look like something that every manager should have blazoned in their collective consciousness, this is not always the case. One reason for this is that different business units often have misaligned definitions for terms as basic as product, customer, or account. In addition, moving to an analysis of exactly which business units have certain capabilities can get quite complex. Once this information is captured in the business architecture, however, the research has already been completed. Capability-to-business-unit mappings are particularly stable. Even reorganizations have a marginal impact.

Capability-to-business-unit mapping is important but there is another aspect of the business architecture that is required to complete at least the highest-level view of business transformation planning — the value stream. As we discussed previously, a value stream is an end-to-end collection of activities that creates a result for a customer. This means that a value stream begins with a stakeholder triggering the first stage of the value stream and ends when a product or service, notification, a degree of satisfaction, or other communication is delivered back to that stakeholder.

Value streams are decomposed into a series of stages that move from left to right with an arrow connecting each stage. Value is accrued at each stage. Stages are expressed in verb/noun format such as “process payment.” Consider a value stream where a policy is prospected, sold, recorded, paid for, and the stakeholder is notified accordingly. A sample value stream is shown in Figure 7.

Value streams should not be confused with business processes because they represent a high-level view

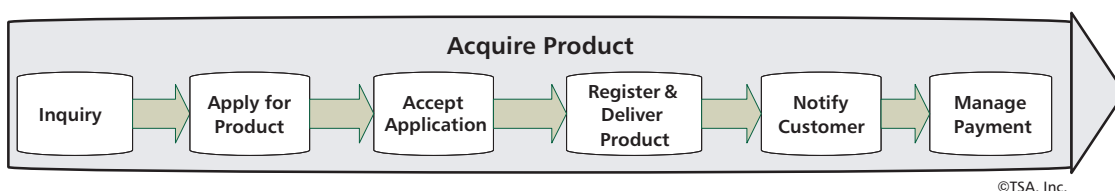
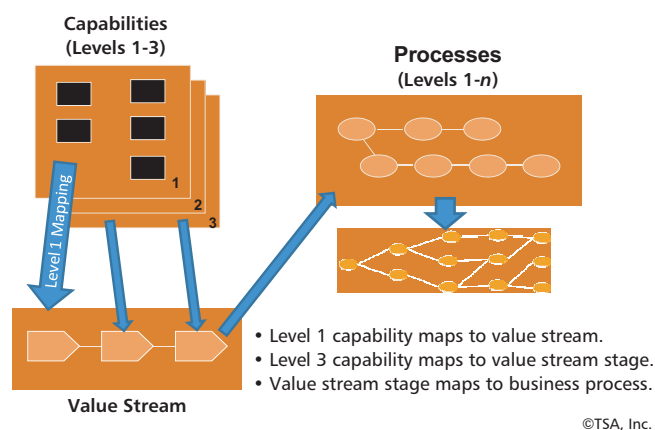

Figure 7 — Value stream example.

that aggregates all paths, rolled up into an executive friendly view void of decision structures, alternate routes, or information. Process analysts often call this the “happy path.” Value streams enable a wide range of capabilities and capabilities can be mapped to each stage of the value stream. Capability, value stream, and business process mapping is shown in Figure 8.

Figure 8 shows how the highest-level capability maps to an entire value stream. This is primarily for planning purposes. For example, a customer management Level 1 capability may map to two value streams: manage customer information and process claim. Assume that the company allows a customer to update personal information at the same time as sending in a claim to the insurance company. The value stream stage called “update customer information” would then be mapped to the Level 3 capabilities that the stage enabled. This mapping approach plays an important role in front-end/back-end IT architecture transformation initiatives. When project teams align, consolidate, and automate processes across a value stream, underlying business capabilities that are enabled by that value stream are likely to require modernization or service enablement. This concept provides a roadmap for process/user interface transformation along with the synchronized transformation and deployment of back-end application architectures.

Stages within the value stream map to business processes, which typically do not represent end-to-end



©TSA, Inc.

Figure 8 — Capability, value stream, business process mappings.

implementations — unlike the value stream. The value stream represents all processes, regardless of where they are performed or how many stages they cover, within an enterprise that can be mapped to a particular set of value accretion stages. The mapping concept in Figure 8 accommodates both current-state and target-state views. Representing the current state, however, is an important step in understanding where processes can be aligned, combined, synchronized, connected, and ultimately automated in a target state. The value stream provides transformation teams with a current-state and target-state view of opportunities to transform organizations across business units, product lines, and even enterprise boundaries.

Collectively, you can use the capability map and value stream for root-cause analysis, strategic planning, funding allocation, initiative planning, and deployment priority setting and management.

### Business Architecture Knowledgebase

Many capabilities map to multiple organization units, value streams, information assets, and technology deployments. This is where best practices and standards become important. Best practice-based mappings leverage a simple data model or a metamodel to map capability, value stream, and other aspects of business architecture. This enables business architecture teams to scale up analysis efforts as they incorporate more concepts, additional business units, and required levels of granularity. This formal mapping concept is implemented through the business architecture knowledgebase.

The business architecture knowledgebase formalizes the way in which information about the business — including organizational structure, capabilities, value streams, information assets, project initiatives, customers and partners, and related IT assets — is stored, related, and viewed. In a book coauthored with Neal McWhorter, we write:

The knowledgebase provides a vehicle for capturing, assimilating, viewing and sharing a wide range of information that can be readily transformed into useful business blueprints for business and IT professionals.<sup>5</sup>

The knowledgebase can exist in a variety of forms. Some organizations store this information in a database. Microsoft Access is even used in some cases. Others have found that a more robust solution is required long term. Various architecture tool providers, such as MEGA or Troux, offer the underlying repositories that business architects can then customize to represent information about the business. The knowledgebase

should be customizable to the appropriate degree to represent the business and IT assets required for transformation planning and management.

The IT assets being represented in this planning-level business repository would be minimal, while other more extensive IT deployment views could take over the task of tracking IT assets undergoing transformation. Fortunately, the tools we've mentioned support both the business and the IT side of the equation.

### Incorporating Capabilities into Enterprise Architecture

In addition to their fundamental role in business architecture, business capabilities provide an important link between business requirements and the IT solutions across all of the domains of enterprise architecture (EA), as illustrated in Figure 9.

The typical EA stack of architectural domains (business, information, application, and technology) is shown at the top of the figure. Business capabilities are a primary deliverable of the business architecture. We can see that the capabilities can be mapped to value streams, as described earlier. Of course, capabilities require both processes (functional aspects) and information. Information architecture is responsible for defining the fundamental business entities of an enterprise, which should relate directly to information required by the capabilities. We should differentiate, however, that information assets enabling capabilities within business architecture — including customer, product, account, and similar concepts — are part of a business view that is separate from IT-defined information (also called data) architectures.

Application architecture is responsible for defining three important aspects of applications:

1. The fundamental reference architecture that defines how applications will be constructed
2. The integration of applications (both functions and data)
3. Maintaining a portfolio of applications and systems

Modern enterprises today are using SOA as their fundamental reference architecture. A layered reference architecture is shown at the bottom of Figure 9. From bottom to top, the layers are:

- **Operational resources.** This layer consists of existing applications, legacy, and COTS systems, including customer relationship management (CRM) and enterprise resource planning (ERP) packaged applications. These applications provide business operations — transactions that represent single logical

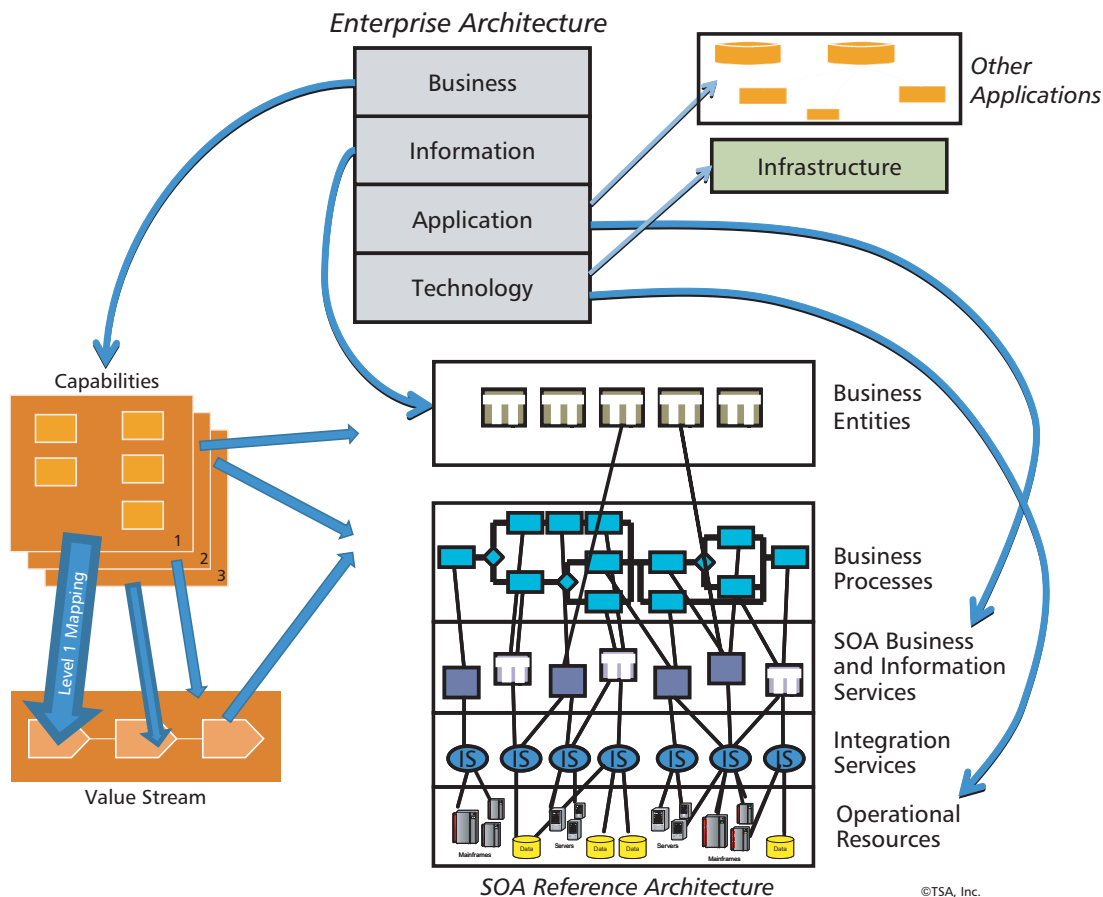

Figure 9 — The role of business capabilities in EA.

units of work in the enterprise's operational systems. Execution of an operation will typically cause one or more persistent data records to be read, written, or modified in a system of record (SOR). Operations have a specific, structured interface and return structured responses. Data at this layer resides in existing applications or databases.

- **Integration services.** Integration services provide integration between and access to existing applications. The separation between the integration services and the business services is critical to maintaining a flexible enterprise environment. This involves transformation of data and function from existing systems to what is desired at the business-service level.
- **SOA business and information services.** Business services provide high-level business functionality throughout the enterprise. Information services provide consolidated, cleaned, and rationalized data about business entities. This layer provides a service interface abstraction and integration of the layer below, breaking the direct dependence between

processes, entities, and existing systems. Services are a managed, governed set of enterprise assets responsible for ensuring conformance to service-level agreements (SLAs). Business services represent logical groupings of operations. For example, view customer profile, look up customer by telephone number, list customers by name and postal code, and save data for new customer all represent the associated operations within the logical service. Note that all operations or data will not necessarily come from the same operational systems, or in some cases, the operations will be replicated across multiple similar systems. Thus, the business and information services provide a virtual implementation of related business operations.

- **Business processes.** A business process consists of a series of operations that are executed in an ordered sequence according to a set of business rules. Business processes are composed of business and information services and typically encompass multiple service invocations. Examples of business



processes are: initiate new employee, sell products or services, and fulfill order.

Previously, we explored the mapping of capabilities and value streams to business processes. Figure 9 illustrates that mapping (capabilities and value stages can be implemented by processes) but expands it to show the relationship between those processes and information and the underlying SOA layers.

Completing our discussion of EA, the technology architecture describes the systems and infrastructure that support the enterprise's application and information. This will include a specific infrastructure to support SOA, such as an Enterprise Service Bus (ESB). But the particular infrastructure is not a concern at the business and information architecture levels. Rather, it is a detail of the implementation. It is important to understand this distinction in interactions with business professionals.

Of course, many systems, applications, and data exist that will not be part of SOA but may continue to provide important functions and information to the enterprise. At a minimum, these systems will be important in understanding the requirements for transformation planning. For completeness, at the top right of Figure 9, we show that the application and technology architectures must account for these systems.

## **ROLE OF CAPABILITIES IN BUSINESS/IT TRANSFORMATION PLANNING**

The business capability plays an important role in strategic planning for business as well as for business/IT alignment. There are several factors that make the business capability an essential aspect of strategic and transformational planning.

### **The Need for Capability-Based Planning**

Situations requiring capability-based strategic planning and investment analysis are commonplace. For example, what if a capability is inadequate or lacking to the point where it is causing market share losses, revenue drops, customer attrition, or regulatory violations? Leveraging a capability-oriented view of your business to address these challenges provides commonality of views across business units and between business and the IT organization. This allows executive teams to view the situation from a holistic perspective, not as a series of piecemeal problems and solutions across various business unit silos.

Consider our previously introduced customer management example. Organizations manage aspects of a customer in many places and in many ways. When one ponders all of the ways in which a business manages a customer, the complexity becomes overwhelming. Enterprises spend a significant amount of time, resources, and executive mindshare on issues such as customer analysis, customer retention, customer information tracking, and customer portfolio management. When customer attrition increases or customer complaints escalate, it triggers considerable executive level debates.

Boards can get involved, marketing develops new campaigns, and IT pours more money into software-related investments to attempt to reverse the tide of customer attrition. While the cause of the problem may be generally known, it is often difficult to articulate and even more difficult to nail down an agreed-upon strategy that will address the problem in short order. Frustration rises among executives because the underlying cause is either unknown or too complex to grasp. This environment gives rise to the "shot in the dark" or "shotgun" solutions.

Shot-in-the-dark solutions attempt to address an issue that is not fully understood due to its inherent complexity. This approach is often characterized by launching multiple parallel efforts within various business units to patch together a solution to a problem that requires a holistic approach. Shotgun solutions, on the other hand, tend to take the form of large-scale, multiyear initiatives covering a wide swath of the IT architecture. Only 3% of these types of projects, which run from US \$10 million and up, have a chance of success.<sup>6</sup>

Making matters even more complex for executive planning teams are the myopic solutions brought to the table by various business units or IT. These proposed initiatives are characterized by solutions that address an issue for a given LOB but do little for, or even complicate, capability deployment from an enterprise perspective. This situation typically manifests itself via funding models driven by a business unit executive that "just needs a problem fixed." Too often, IT tends to view business challenges, such as the customer information issue, as one of data mapping and reconciliation, or as a connectivity issue that can be addressed via an ESB. Without proper business involvement, the approach sidesteps the business-driven analysis needed to ensure that the root cause of the problem is addressed and instead results in redundant, conflicting, and budget-busting projects and solution proliferation.

Making matters worse is that most of the solutions put on the table do not take an enterprise view of an issue. In our customer information example, where customer management is entrenched across every division of the enterprise and even outsourced in some cases, this is a recipe for disaster. Yet, solution teams continue to somehow convince executives to launch an expensive, multiyear effort to reconcile data, deploy costly integration schemes, or even invest in entirely new infrastructures with little clarity as to how these solutions will fix the problem. Individual business units — flying in the face of a consolidated, cohesive solution and approach to these enterprise-wide challenges — continue to sponsor and fund parallel efforts, which address only part of the problem and ultimately run into conflict while eating up scarce resources and delivering little value.

Applying shot-in-the-dark and shotgun solutions when a laser-like resolution is required is a choice of last resort. Unfortunately, the last-resort approach is taken much too often and typically tied to the lack of visibility into the horizontal and vertical impacts of the problem and proposed solutions. The better, alternative approach is to focus on the business capability or capabilities that are underperforming and drive change out from that point across the entire business and into the IT architecture.

### Capability-Based Analysis and Planning

Executives use capability maps as input to strategic business analysis and planning, particularly when viewed as a color-coded “heat map.” Figure 10 shows an example of a heat map. In this example, certain Level 3 capabilities have been coded or marked as underperforming (yellow) or in serious need of attention (red). Those capabilities performing as expected are shown as green, while those capabilities with no color designation have either not been evaluated or are not of interest (not shown in the figure).

In Figure 10, vendor information management was fragmented in such a way that it was costing the organization millions of dollars a year in overpayments, missed consolidation opportunities, or excess management and effort. Consolidating this capability into a single business unit addressed the issue, but this required a broader understanding of where those capabilities currently existed. Although many organizations have addressed vendor and procurement challenges, it is much more difficult to address problems when the issues and solutions are larger and spread across many business units, processes, and technology deployments.

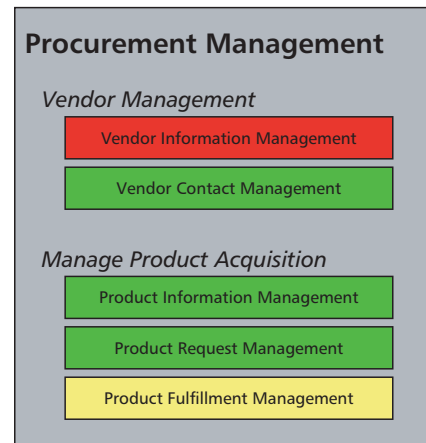

©TSA, Inc.

Figure 10 — Heat mapping a business capability.

Heat map analysis is only the first step in determining where to look to address a particular issue. The discussions that result from such an analysis are shown in Figure 11.

Figure 11 illustrates the use of focusing issue analysis and resolution discussions on business capabilities and not on a given business unit, person, or technology deployment. In this example, you can see that vendor contact management has been marked as “red” according to standard heat map protocol, showing that this capability is a problem area requiring management attention. In this example, vendor data was scattered across many business units, managed by numerous teams, and identified as a priority issue that had to be addressed. As a rule, problem analysis typically jumps to a solution before proper analysis has been performed. Pinpointing the capability-based limitations or issues is an objective vehicle for moving beyond the first-trap solution.

Once the issues have been identified, the first step in planning a solution is to determine what is being done to date to address a particular limitation within a capability. There are normally numerous “in flight” initiatives underway at any given enterprise, and capabilities can point the way here as well. By determining how many in-flight projects are currently impacting or planning to impact a set of capabilities under review, executives can assess the amount of investments already being made to address a particular problem. If those projects are viewed collectively, from the impact they will make or not make on a given capability, and the overlap, incompatibility, or synergy they bring, executives can determine if they should continue funding, consolidate, or even cancel certain initiatives.

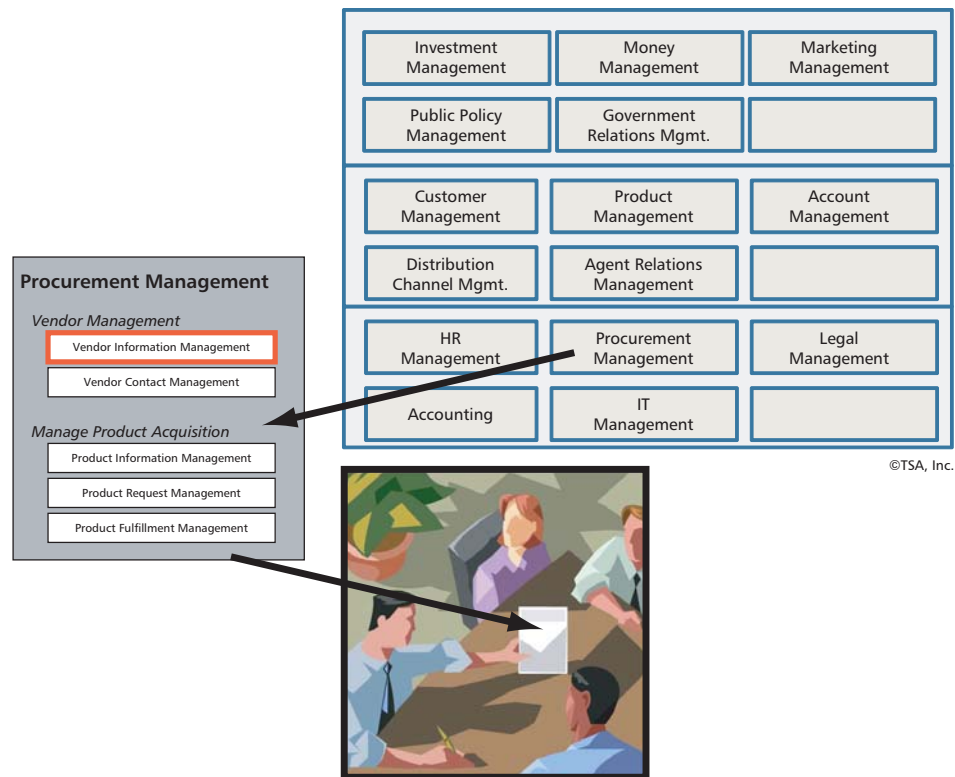

Figure 11 — Capability-based strategic planning.

Carrying the concept of capability-focused investment analysis to the next step, capability-based planning enables executives to discuss where to focus funding and how to stage an initiative to gain the most value out of their investments in the least amount of time. Right now, many major initiative investments are geared at some grand goal, like totally revamping the entire order processing and fulfillment process. Yet these initiatives tend to be long term and can lack focus on delivering near-term value.

For example, if you are losing customers and market share, there is an expectation on the part of the executive team that the issue will be addressed quickly. One company found that there had been a 10-year initiative underway to rethink customer management, all the while customers were walking away from the company. The work completed by this project was incorporated into the new strategy, thereby building upon work already completed and delivering value quickly and for a fraction of the amount spent to date.

The important consideration here is to determine and review all major areas where work must be done in order to rectify a given business issue. This involves driving the analysis down to increasing levels of detail that allow work to begin on a resolution while more details are uncovered as part of the implementation or

during a parallel phase. Figure 12 highlights the high-level to low-level mappings that enable business/IT transformation planning to move from the capability across value streams and business processes and into various aspects of the IT architecture.

We introduced a portion of these mappings in Figure 8 and have now extended the analysis into the application architecture and the user interface layer. This simple view, which is fully supported by the business architecture knowledgebase, takes a business-first approach to transformation analysis and planning. The concept shown in Figure 12 provides the foundation for two important aspects to business/IT alignment.

Value stream/process/user interface mapping enables the alignment, consolidation, and automation of business processes using new front-end BPM automation tools, and, where applicable, case management for complex, document-driven states across a value stream. In addition, capability/application/information architecture mapping enables prioritization and phased deployment of new services and modernization of backed architectures. The connecting point is the link between business capability and value stream.

There are several important principles that support the use of this mapping concept. These include:

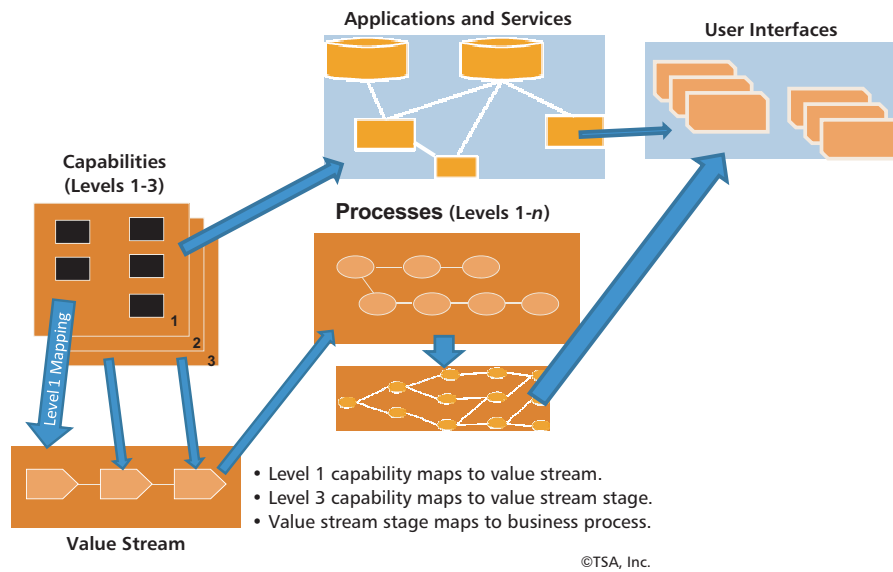

Figure 12 — Capability, value stream, business process mapping to IT architecture.

- Capabilities define which value streams require analysis and transformation.
- Value stream-driven, business process alignment analysis enables prioritization and roadmap development for rapid response resolution of front-line business issues.
- Value stream analysis is the basis for horizontal and vertical business process alignment.
- Business capabilities are robust representations of fundamental (and unique) business requirements and therefore provide a concise mapping to target-state SOA business and information services.
- Business capabilities provide the foundation for current-state application architecture analysis, decoupling, and transformation.
- Business capabilities form the basis for longer-term transformation of information assets and back-end data architectures.
- Business and IT architectures evolve at a pace that enables continuous business/IT synchronization.
- Business and IT architectures evolve at a pace that the business can both drive and absorb.

These principles drive much of the transformation roadmap development and initiative deployment. The concept is based on the premise that front-end architectures (where processes meet user interfaces and user-deployed technologies) can evolve at a pace that can be decoupled from the evolutionary pace of

back-end architectures (IT applications, middleware, and data sources). This means that business processes can be aligned, consolidated, modified, and automated under a general architecture strategy that provides rapid business ROI. As this occurs, back-end application and data architecture strategies and plans can evolve, resulting in a phased migration of these back-end architectures to the new target state. We will apply these concepts to our transformation roadmap discussion in the next section.

### Business/IT Transformation Roadmap Development

A business/IT transformation roadmap is a high-level vision of the major phases, steps, and related dependencies to be considered as a strategy evolves. The important concepts that go into building a roadmap include:

- Business vision for what should be accomplished
- Business capabilities and value streams impacted by a given strategy or executive mandate
- Time frame requirements and related business priorities
- Analysis as to which aspects of a given strategy should come first based on business priorities
- IT vision that corresponds to the business vision
- Service, information, and technology infrastructure required to support the transition
- Governance requirements to enable a sustainable business/IT transformation initiative

For example, we discussed the loss of customers and how it was impacting the business. In our prior example, customer management capability decomposition, related business mapping, and root-cause analysis found that several lower-level capabilities within customer management were performing at suboptimal levels. The same customers were being viewed as multiple stakeholders across different business units, forcing customers to receive conflicting company information, clouding the status of a given customer when viewed across product lines, and generally aggravating customers who were making inquiries.

One of the lower-level capabilities in question was called “information verification.” This was initiated whenever a new or returning customer tried to acquire a product from a different LOB than the customer had dealt with in the past. Several value streams required the information verification capability, one of which was the acquire product value stream. Figure 13 shows this value stream and the various capabilities it enables along the bottom.

This analysis determined that this capability and several related capabilities that spanned multiple value streams had to be incorporated into the roadmap. While the impact on the update customer information value stream was much more significant and required a priority-based reworking of underlying processes, the impact on the value stream in Figure 13 was much more subtle.

The holistic analysis of these value streams and capabilities allowed planning teams to identify the SOA

business and information services required to consolidate, aggregate, and enhance the existing system in order to automate this particular capability. The impact to the value stream and underlying processes was limited to the third stage of the value stream, allowing management to minimize investment in this value stream. Analysis showed that the update customer information value stream, on the other hand, required reworking the front end of a number of processes deployed across multiple business units.

In the case of the update customer information value stream (not shown in our example), underlying processes required significant aggregation and consolidation within the initial and back-end stages. The initial stage, called “accept customer request,” had to be augmented with a second stage called “route customer request.” This was an adjustment to the value stream driven by the need to ensure that all product lines, business units, and outsourced business units received customer change requests. This required the addition of a new Level 3 capability and a new corresponding SOA service to handle customer requests and transparently perform contact information aggregation and consolidation. Coupled with process changes and automation of Stage 1 of the value stream, the work to add this capability was minimal but yielded significant benefits.

Additional back-end application and data architecture changes were also identified, as shown in Figure 14. These changes impacted much of the core of the value stream and required back-end applications to begin using a newly created service for managing customer information. These collective changes were envisioned

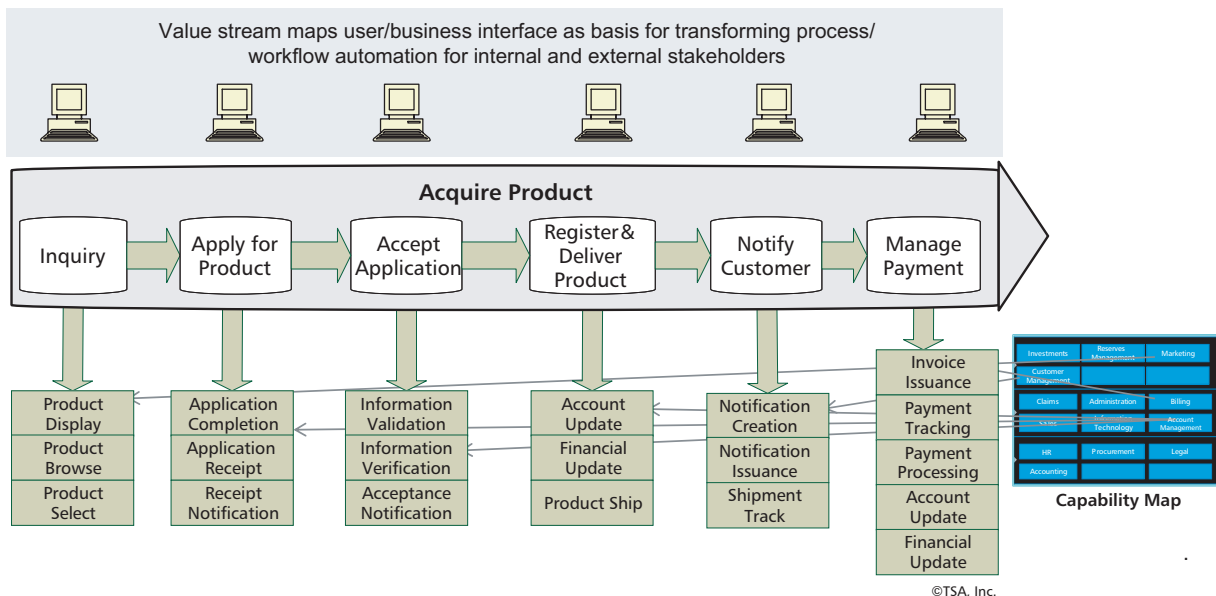

Figure 13 — Value stream-driven view of process alignment and automation.

over a much longer period of time. The value delivered near term, however, through simple changes to the front end of one value stream, and a small subset of associated business capabilities (automated via SOA services) delivered significant business value.

The transformation roadmap had to include value stream/process automation of selected stages in the near term, small capability automation steps, longer-term SOA creation and deployment, consolidation of back-end data architecture focused on customer information, and phased decoupling and migration of back-end application systems to begin using the new services where applicable. In addition to the value stream/process automation work, SOA deployment, and back-end modernization, the capability-based analysis approach also allowed planning teams to identify the specific business information and related data architecture changes required over the long term.

A capability-driven, business/IT transformation roadmap, as our example highlights, allows executives, planning teams, and architecture teams to balance investments and resources where they provide important payback in the near term and address the longer-term needs. Thus, a long-term strategy unfolds based on these early efforts. This demonstrates the importance of foregoing shotgun and shot-in-the-dark solutions for focused

strategies that pinpoint the issues requiring resolution and build a basis for executive buy-in and funding.

### Extending Capability Mapping into IT Architecture Planning, Creation, and Design

A major challenge of IT planning is dealing with the current state of redundant and overlapping applications and information. For example, mergers and acquisitions instantly result in redundant applications and data. Siloed IT support for business units is another prime cause (e.g., in finance, it's not unusual to see every business unit implement their own "risk evaluation" system). Regardless of the causes, every organization has this problem to some extent, and business needs to identify the redundancies and overlaps and create solutions that eliminate them and consolidate functions and information. This is especially critical in scenarios where the business needs to operate across business units more effectively.

One approach has been to map business processes to the systems that implement them, but often the processes themselves are redundant and overlapping. The complexity (many-to-many associations) of these maps do not yield a clear and understandable approach. Instead, we use the business capability as the fundamental concept, yielding a much clearer picture of

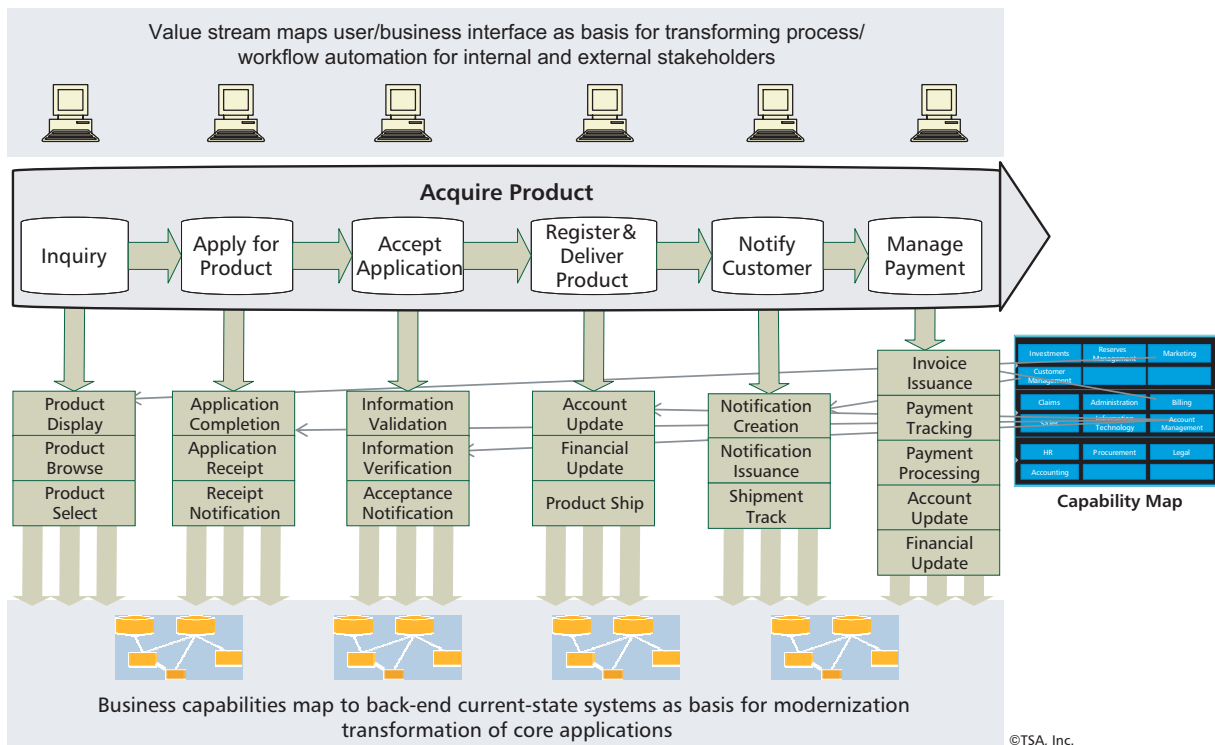

Figure 14 — Value stream/capability mapping to back-end application architecture.

the overlap between systems supporting the same capability.

Figure 15 illustrates the concepts of this mapping. The left side of the drawing shows a (simplified) current state, where capabilities are mapped to the applications and data that support them. Three important issues can be identified by this mapping:

1. **Redundancies.** The same capability is implemented by multiple systems. We would expect to see a fair amount of redundancy in most enterprises. It is not unusual to see 10 or 20 different systems supporting the same capability.
2. **Overlaps.** Some systems implement multiple capabilities or portions of capabilities. It is common to have both redundancies and overlaps.
3. **Gaps.** Capabilities that have been identified as necessary to meet (new) business requirements do not yet exist. In establishing the new capabilities, it is important to avoid creating new redundancies and overlaps.

IT architecture planning desires to address all three of these issues:

1. To remove redundancies by eliminating and consolidating duplicate systems and information

2. To reduce overlaps by breaking capabilities out into more modular systems
3. To fill gaps by enhancing existing systems or acquiring new ones

The right side of Figure 15 shows the future state, where capabilities are implemented by business and information services and where redundancies, overlaps, and gaps have been eliminated, resulting in a simplified and streamlined set of operational systems.

Of course, this is easier said than done, but business capabilities provide the intermediate abstraction that brings clarity to an otherwise fuzzy problem. Business capabilities provide the link between two complex, disparate environments: that of the business and IT architectures. The capability view of the business provides the high-level foundation for alignment between them. Capability maps don't reduce the complexity; rather, they illustrate it in ways that provide new insight. Capability maps link the capabilities up to the strategies, goals, objectives and down to the processes, applications, systems, services, and sourcing that implement them.

A key step in planning and implementing this transition is dealing with existing applications. Again, capabilities can play a key role in enabling the intelligent and effective modernization of existing applications.

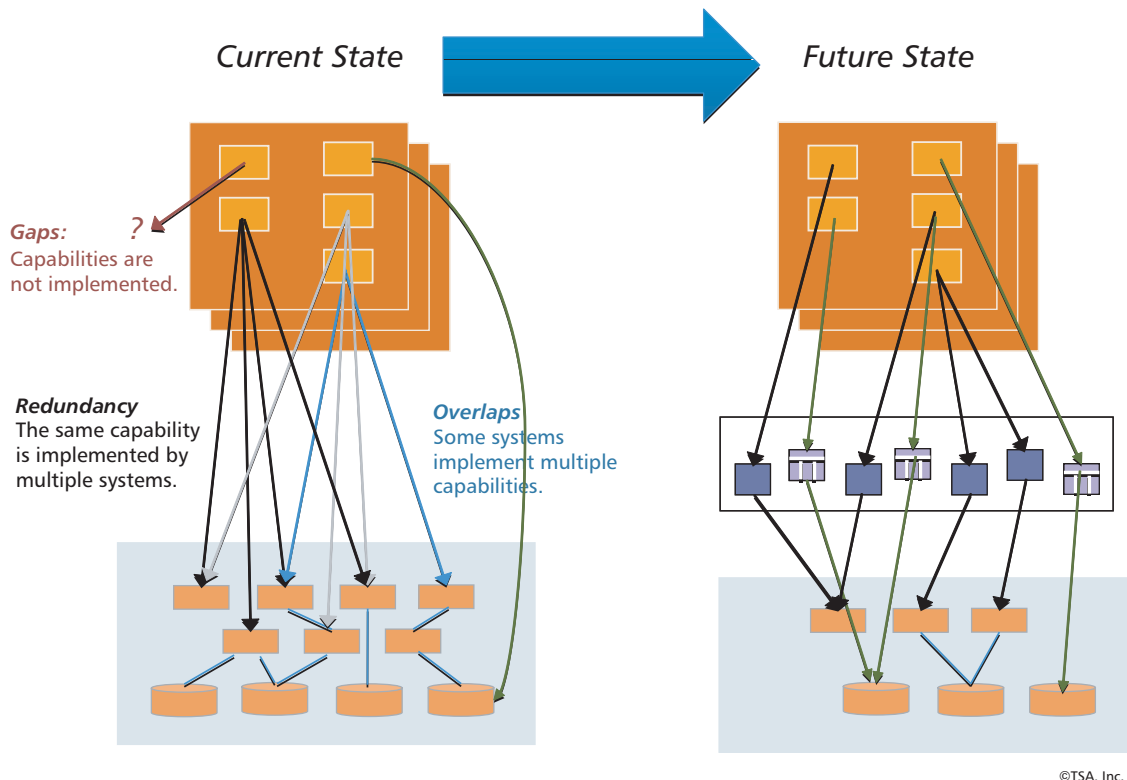

Figure 15 — Capability mapping to future-state architecture.

## Capability-Driven IT Architecture Modernization

When it comes to back-end application architecture transformation, capabilities truly are the Rosetta Stone that IT architects and analysts have been seeking. We have seen architecture teams attempt to map applications to value streams and business processes only to be frustrated at the large number of many-to-many mappings. In many organizations, a given value stream will touch many organizations and require automation from a large number of diverse and redundant applications. For purposes of application architecture transformation planning, the value stream/application mapping approach is highly inadequate. When capabilities are introduced into the equation, however, the clarity of where, when, and how value stream/business process changes require new services deployments or transformational changes to back-end application architectures emerges. The key here is identifying where along a value stream certain capabilities exist and must be automated or otherwise modernized.

In our transformation roadmap section, we discussed how capabilities map to various stages within a value stream and that these capabilities also map to back-end applications. Like SOA initiatives that benefit from understanding where capabilities can drive the need for new services, capabilities also drive the evolution (modernization) of current-state application architectures in a variety of ways. Figure 16 shows the Level 4 capabilities, introduced in Figure 4, mapped to a set of existing applications and subsystems. This mapping concept, fully supported by the business architecture knowledgebase, provides a roadmap approach to where and when certain back-end application logic should be consolidated, eliminated or deactivated, migrated, or begin to invoke a new service in the evolving SOA environment.

The analysis required to perform this mapping evolves through various stages of implementation, as outlined by priorities set within the business/IT transformation roadmap. Back-end information architectures must undergo similar incremental evolution and must be synchronized with this effort. Under this approach, the current-state application architecture undergoes a series of evolutionary upgrades, moving continuously toward a new target state. This effort evolves into a phased synchronization with the automation and synchronization of front-end value streams and business process and must fully support the decoupling and evolution of middleware deployments.

SOA provides another advantage in support of this evolutionary approach. It is expected that a service will continually undergo an evolutionary cycle, and, that for some period of time, multiple versions of the same service will be supported. This means that applications can be transitioned to use a service now, at the same time as the service is evolving. An application will be guaranteed to be supported on a given version of the service for an agreed-upon time frame (typically 18-24 months after the next major service version). In the mean time, new versions of the service will be enhanced to support the transition of additional applications. In the future, when the earlier applications need to undergo some sort of maintenance, they will also upgrade to the latest service version. We have seen this incremental approach used to successfully migrate 80 different product lines onto a common representation of a customer over a multiyear period.

Figure 17 shows one example of a back-end transformation path that can occur for a set of applications. In this example, the current-state applications have been analyzed and mapped to certain business capabilities. A subsequent set of steps served to slice out software

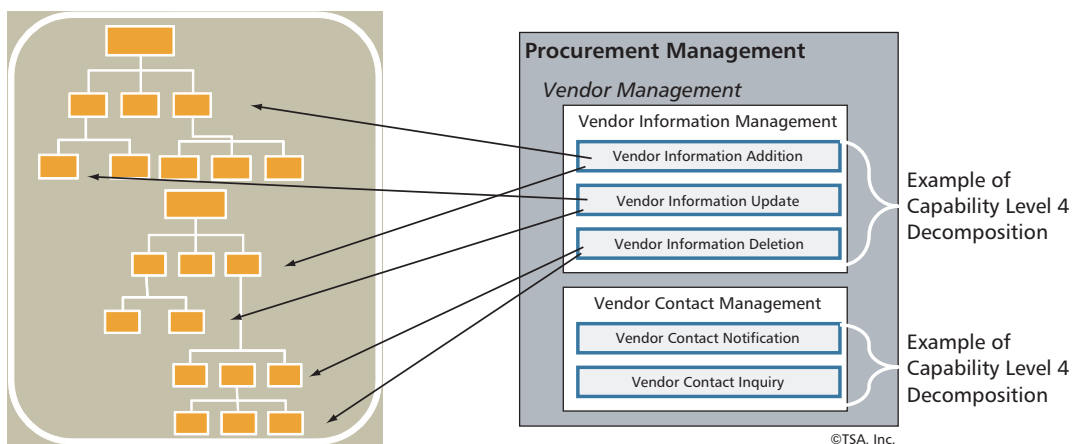

Figure 16 — Capability-to-back-end application architecture mapping.



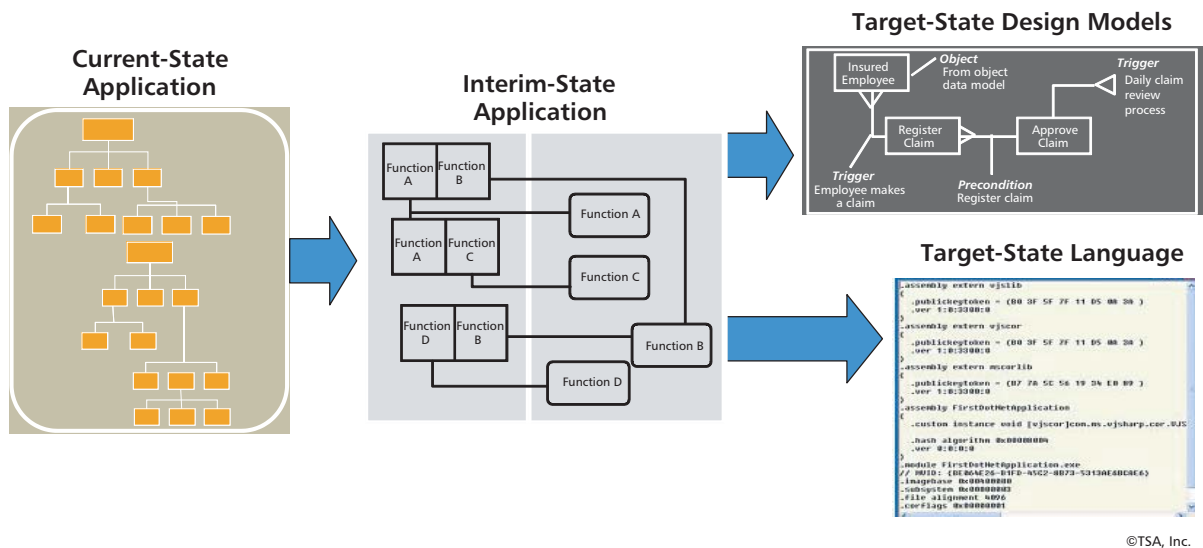

Figure 17 — Capability-based transformation to back-end application architecture via modernization.

that is no longer active, consolidate software logic that is still in use and critical to the business, and create an interim application deployment of highly componentized application software. This concept is enabled by powerful modernization tools that can analyze as well as decouple application software from the viewpoint of systemic (versus program by program) perspective.

The concepts in Figure 17 can be implemented in various ways. This includes the slicing of business logic from current-state applications with the intent to reuse that logic in a deployed service, the extraction of business rules with the intent that these rules can be moved into model-driven paradigms, and the redeployment of that logic in either a code-based or executable model-based representation. The key is to leverage business capabilities as the driver of this effort, which can include taking those capabilities down to Levels 4, 5, or even 6. Over time, the current-state architecture is transformed into a new target architecture that aligns with new SOA deployments, information, and front-end, process-centric changes.

## CONCLUSION

We have described the business capability map as the Rosetta Stone of business/IT alignment. The metaphor suggests that a disparity exists between the intentions of the business and the IT systems used to automate it. As anyone in either business or IT knows, this disparity is real, and both constituents have been struggling to bridge the gap for decades. Unfortunately, these efforts have met with little success — until now.

What has been missing is a key that is capable of expressing the important concepts and translating between them. The business capability, by describing what the business needs to do, not how it should be done, provides a concise vocabulary in business terms that can drive transformation initiatives. The capability view of the business provides the high-level foundation for alignment and bridges the business/IT chasm.

In this *Executive Report*, we have covered what a capability is, how to identify and define the capabilities, and how to use them to plan for and achieve a successful business transformation. We're confident that they can play a key role in your business transformation efforts going forward.

## ENDNOTES

<sup>1</sup>Homann, Ulrich. "A Business-Oriented Foundation for Service Orientation." Microsoft, February 2006 (<http://msdn.microsoft.com/en-us/library/aa479368.aspx>).

<sup>2</sup>Whittle, Ralph, and Conrad B. Myrick. *Enterprise Business Architecture: The Formal Link Between Strategy and Results*. CRC Press, 2004.

<sup>3</sup>See [bawg.omg.org](http://bawg.omg.org) and [www.businessarchitectureinstitute.org](http://www.businessarchitectureinstitute.org).

<sup>4</sup>Ulrich, William. "Capabilities & Value Streams: Business Architecture's Essential Alliance." BPM Institute, 22 November 2010 ([www.bpminstitute.org/articles/article/article/capabilities-value-streams-business-architecture-essential-alliance.html](http://www.bpminstitute.org/articles/article/article/capabilities-value-streams-business-architecture-essential-alliance.html)).

<sup>5</sup>Ulrich, William, and Neal McWhorter. *Business Architecture: The Art and Practice of Business Transformation*. Meghan Kiffer Press, 2010, p. 210.

“Chaos Summary 2008: The 10 Laws of Chaos.” The Standish Group, 2008.

## ABOUT THE AUTHORS

**William M. Ulrich** is a Senior Consultant with Cutter’s Business-IT Strategies, Enterprise Architecture, and Government & Public Sector practices and President of TSG, Inc., a management consulting firm that specializes in business and IT planning and transformation strategies. Mr. Ulrich has more than 30 years’ experience in the business-IT management consulting field. He serves as strategic advisor and mentor on business-IT alignment initiatives and continues to work as a workshop leader and author. He has the unique ability to cross business and IT boundaries to facilitate and streamline business-IT transformation strategies. Mr. Ulrich’s workshops on business-IT architecture alignment have been widely attended by organizations worldwide. His ability to communicate fluently with business executives and professionals and IT executives and professionals has enabled him to help organizations craft transformation strategies that deliver incremental and ongoing business value while managing risk and costs at each stage of deployment.

Mr. Ulrich currently serves as Cochair of the OMG Business Architecture Special Interest Group, Editorial Director of the Business Architecture Institute, Cochair of the OMG Architecture-Driven Modernization Task Force, and is a member of the EA Advisory Board for Penn State. His latest books include *Business Architecture: The Art and Practice of Business Transformation* and *Information Systems Transformation: Architecture-Driven Modernization Case Studies*. The approaches outlined in these two publications provide a balance to the challenges inherent in delivering business-driven, business/IT transformation. He can be reached at [wulrich@cutter.com](mailto:wulrich@cutter.com).

**Michael Rosen** is Director of Cutter Consortium’s Enterprise Architecture practice and Senior Consultant with its Business-IT Strategies practice. He is an accomplished architect and technical leader with extensive experience in EA, SOA, business architecture, product strategy and development, software architecture, consulting and mentoring, distributed technologies, and industry standards.

Mr. Rosen specializes in architecture and IT strategy for Global 1000 clients in finance, insurance, government, and telecommunications. Throughout his career, he has been a frequent technical trainer, speaker, and writer on such topics as EA, application integration with SOA, Model Driven Architecture (MDA), and Enterprise 2.0 and collaboration architecture. In addition to his position as Cutter’s EA Practice Director, Mr. Rosen is Chief Scientist with Wilton Consulting Group. He previously served as CTO of Azora Technologies, a startup focused on SOA analysis, design tools, and reference architecture; CTO of M2VP, Inc., a consultancy for IT architecture, where he developed the company’s practice area using MDA; Chief Enterprise Architect at IONA Technologies, PLC, where he engaged in the development of the overall product architecture for its next-generation Web services platform and in the creation of the reference architecture for building applications on that platform. Prior to IONA, Mr. Rosen was Chief Enterprise Architect at Genesis Development, where he provided architecture consulting on large-scale applications and infrastructure. Before joining Genesis, he was a product architect, technical leader, and developer for numerous Web services, Java, CORBA, COM, messaging, transaction processing, DCE, networking, and operating system products for several vendors, including BEA and Digital.

Mr. Rosen has authored dozens of articles and reports and is coauthor of *Applied SOA: Service-Oriented Architecture and Design Strategies*; *Developing E-Business Systems and Architectures: A Manager’s Guide*; and *Integrating CORBA and COM Applications*. He is a founding member of the Business Architect’s Guild and is active in industry standards with the OMG. He can be reached at [mrosen@cutter.com](mailto:mrosen@cutter.com).

# Consulting



## Enterprise Architecture

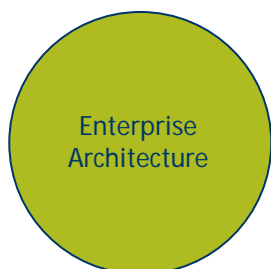

## Enterprise Architecture Consulting

Cutter Consortium offers advice and guidance from world-renowned consultants. The Consortium features a faculty whose expertise and credentials are unmatched by any other service provider.

Moreover, unlike many other consulting firms that use senior partners to sell a job but then assign junior staff to actually perform the work at the customer's site, Cutter has no junior staff and deploys only its expert Senior Consultants, Fellows, Architects, and Technical Coaches on every assignment. The Consortium's great strength is that it can draw on its more than 150 best-in-class consultants to assemble the ideal team for your organization, tackling any challenge that might arise, and offering a complete solution from assessment through implementation.

In addition, Cutter does not rely on off-the-shelf solutions like so many consulting firms. Cutter's customized EA engagements are designed specifically to meet the needs of the individual client. We see that many clients have similar problems; therefore, we have developed templates around these common areas to act as a starting point for discussions that will refine the focus, output, and duration of the project to match the client's particular needs and circumstances.

### Enterprise Architecture or SOA Maturity Assessment

Through a qualitative and quantitative evaluation of your architecture and organization, Cutter's maturity assessment program provides a relative comparison of the organization to industry norms and identifies strengths and areas needing attention.

Cutter's approach to architecture assessment is first to understand the goals and drivers of the architecture program and then to evaluate the initiative in terms of meeting those goals. This leads to the selection and prioritization of specific architectural characteristics and evaluation criteria to apply during the assessment. Specific architectural best practices and processes that lead to meeting the program goals are identified. These should fit the enterprise's environment, culture, structure, processes, organization, and so forth. The overall maturity is based on an evaluation of the criteria, processes, and practices.

Cutter applies an additional important dimension to the evaluation by identifying specific areas of value (or ROI) that can be delivered to the enterprise based on meeting certain maturity targets and criteria. This allows decision makers to understand and evaluate the value that an investment in the architecture program will bring.

The final step in the assessment process is to develop a roadmap for architecture to deliver value and meet the enterprise goals. The roadmap includes specific maturity targets and checkpoints that allow the organization to quantitatively measure the progress of the EA program with regard to specific criteria, processes, practices, and results.

The engagement includes a report summarizing the maturity assessment process; the level of maturity of the client organization; strengths, weaknesses, and recommendations; and the roadmap.

### Enterprise Architecture Enablement

Cutter's enterprise architecture enablement program allows companies to receive an expert objective opinion on the current state of their enterprise or service-oriented architecture (SOA) initiatives and to work with Cutter's Senior Consultants to formulate an end-state vision and prioritized action plan.

Because the enablement program is limited in scope to four or five days, it provides a low-cost, low-risk approach that demonstrates the value that Cutter can bring to your organization, allowing your organization and Cutter to get familiar with one another and,

together, to determine how to maximize the value of any further consulting.

The enablement includes a report summarizing the engagement along with an initial high-level architectural vision and roadmap. Although every report is different, a sample table of contents might include:

- Executive summary
- Impressions
- Goals, deliverables, and strategy
- Evaluation of specific questions addressed during the engagement
- Recommendations
- Action plan

## Enterprise Architecture, Business Architecture, or SOA Program Development

Cutter works with many organizations that currently have or are initiating architectural programs. The most common scenarios are:

- Initiating a new architecture program, moving beyond the pilot project
- Rolling out an EA or SOA program
- Expanding EA's reach and influence with business architecture
- Addressing an existing program that is not delivering the expected value
- Evaluating an existing program to keep it aligned with industry best practices

Cutter works with clients to address the issues and develop a strategy that is right for their organization. For example, an SOA rollout program would recommend a high-level strategy and roadmap for transitioning to an SOA. The roadmap would specify checkpoints, time frames, and result targets and include the relative priority, scope, and deliverables of specific activities, such as:

1. Alignment of architecture with business and organizational strategy
2. Pilot projects
3. Infrastructure and tools improvements or deployment

4. Development or improvement of specific architectural processes
5. Organizational goals and structure
6. Architectural governance
7. Metrics
8. Development of specific architectural artifacts
9. Communications
10. Education and mentoring

## Architecture Review and Action Plan

The Architecture Review and Action Plan provides an in-depth evaluation of your enterprise's architecture. It takes an architectural approach to addressing specific questions and concerns that you may have. It is intended to clarify business, application, and technology discussions and help your organization make specific technology decisions.

This approach analyzes the enterprise architecture and infrastructure that will be required to meet your objectives, whether they involve an EA, an organizational transition, or the implementation of a single application using architecture-focused development techniques. The approach articulates the business, technology, and development goals as well as the architectural requirements implied by these goals. And it highlights technical issues that might impede achievement of these requirements and goals.

An important deliverable of an Architecture Review and Assessment is the initial design of a target architecture. This could be a high-level SOA, a draft business architecture, or an application or technology architecture. For example, a draft technical architecture might present the services, frameworks, and design patterns that constitute a true enterprise-scale architecture that is tailored to your enterprise's current situation and future goals.

The Assessment includes an in-depth report, typically on the order of 75 pages, which takes 20-25 days to research and to produce. A sample table of contents might include:

- Executive summary
- Goals and strategy
- Evaluation of current architecture
- Target architecture
- Specific requirements addressed by target architecture
- Recommendations
- Action plan

## A Sampling of Additional Consulting and Training Offerings

- **Architectural Development.** Cutter will create specific architecture deliverables, including target architectures, specifications, and models.
- **Independent Design Review.** Our EA team can perform a detailed evaluation and provide recommendations of project architectures and designs. This provides your organization with independent expert analysis of projects against industry best practices and standards as well as specific project requirements and goals. This is often used to validate the design of a project that is being outsourced.
- **Periodic Reviews.** Periodic reviews of architectures and programs by a Cutter Senior Consultant typically occur two to four times per year and provide the CIO, Chief Architect, or Director of Architecture with specific reviews and recommendations.
- **Strategic Advice and Alignment.** Occurring periodically like the reviews, these strategic advice and alignment engagements focus on providing strategic technology advice to the CIO or others at the executive level.
- **Custom Training and Mentoring.** Cutter's training options range from half-day executive seminars, to one- or two-day workshops, to a comprehensive six-course curriculum. Our techniques include presentations, hands-on workshops, and on-the-job mentoring.

# Enterprise Architecture Practice

Today the demands on corporate IT have never been greater. Cutting costs and accelerating time to market for individual line-of-business projects are still priorities, but even that's not nearly enough anymore. Companies are now looking for strategies to better leverage their entire IT infrastructure. They want IT to deliver sophisticated enterprise applications that can provide value across many lines of business and provide marked differentiation from their competitors. The Enterprise Architecture Practice provides the information, analysis, and strategic advice to help organizations commit to and develop an overarching plan that ensures their whole system fits together and performs seamlessly.

The Enterprise Architecture Practice offer continuous research into the latest developments in this area, including Web services, enterprise application integration, XML, security, emerging and established methodologies, Model Driven Architecture, how to build an enterprise architecture, plus unbiased reports on the vendors and products in this market. Consulting and training offerings, which are customized, can range from mapping an infrastructure architecture to transitioning to a distributed computing environment.

## Products and Services Available from the Enterprise Architecture Practice

- The Enterprise Architecture Advisory Service
- Consulting
- Inhouse Workshops
- Mentoring
- Research Reports

## Other Cutter Consortium Practices

Cutter Consortium aligns its products and services into the nine practice areas below. Each of these practices includes a subscription-based periodical service, plus consulting and training services.

- Agile Product & Project Management
- Business Intelligence
- Business-IT Strategies
- Business Technology Trends & Impacts
- Enterprise Architecture
- Enterprise Risk Management & Governance
- Government & Public Sector
- Innovation & Enterprise Agility
- IT Management
- Measurement & Benchmarking Strategies
- Social Networking
- Sourcing & Vendor Relationships

# Senior Consultant Team

Our team of internationally recognized specialists offers expertise in security issues, e-business implementation, XML, e-business methodologies, agents, Web services, Java EE, .NET, high-level architecture and systems integration planning, managing distributed systems, performing architecture assessments, providing mentoring and training, overseeing or executing pilot projects, and more. The team includes:

- Michael Rosen, Practice Director
- Paul Allen
- Scott Ambler
- Douglas Barry
- Dan Berglove
- Udi Dahan
- Max Dolgicer
- Don Estes
- Pierfranco Ferronato
- Clive Finkelstein
- Jerry Grochow
- Michael Guttman
- David Hay
- Tushar K. Hazra
- Dave Higgins
- Bartosz Kiepuszewski
- Sebastian Konkol
- Arun K. Majumdar
- Terry Merriman
- James Odell
- Ken Orr
- Mark Peterson
- Jorge V.A. Ronchese
- Oliver Sims
- Borys Stokalski
- William Ulrich
- Mitchell Ummel
- Jeroen van Tyn
- Jim Watson
- Tom Welsh