

Don't forget  
to check the  
light bulbs

# 1982 Avion Owner's Manual

White wire is ground in RV

Gas tanks - pressure needs to be at 11 - 40 lb tanks  
Hot water heater - if it doesn't light push button again  
Hot water heater - Drain from outside -  
Do not use pump when hooked up to water  
Leave 12V - Switch on when going to storage

switch  
#1 - Black } water  
#2 - Gray }

Water: add 4 Efferdent tablets to tank to freshen the water

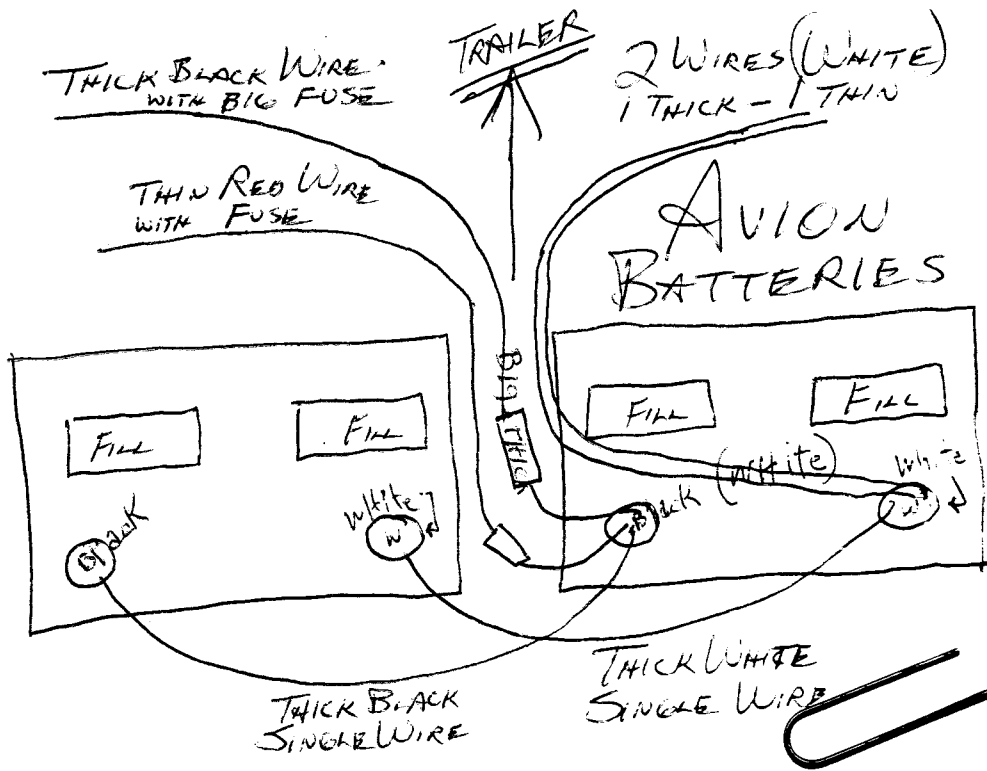

---

Welcome to the era of Avion... the finest travel trailer ever built.

Your Avion brings together in one beautifully-crafted unit the essential trailering values of roadability, livability and durability. It has been designed and engineered without compromise to remain a timeless classic in styling and function for many years to come.

Avion is manufactured to exacting quality control standards by Avion Coach Corporation, a wholly-owned-and-operated subsidiary of Fleetwood Enterprises, Inc. ... the world's largest, most experienced, most successful builder of recreational vehicles and mobile homes. Your new coach is the flagship product of the Fleetwood family, which includes such other familiar names as Terry, Prowler, Wilderness and Taurus trailers, and Pace Arrow, Tioga, Jamboree and Southwind motor homes.

Fleetwood has attained top position in the industry through the efforts of its founder and Board Chairman, John C. Crean. The company was originally established in 1950 as Coach Specialties, to manufacture an improved recreational vehicle venetian blind that he had invented and patented. Within a short time, however, he was also building a line of travel trailers, and the Fleetwood name emerged. What had started as a one-man business grew rapidly under the leadership and innovative marketing skills of John Crean into a far-reaching operation comprising over 50 manufacturing plants, 7000 employees, and more than 2700 authorized dealers who sell and service Fleetwood recreational vehicles in the United States and Canada.

This Owner's Manual is your guide to the operation and maintenance of your Avion. It has been prepared to familiarize you with the many features and capabilities of your new coach and to help you avoid unnecessary problems. We encourage you to read the Manual carefully and to keep it in your Avion at all times. A thorough knowledge of what to expect, and how to correct minor difficulties, will give you a feeling of complete confidence whenever and wherever you travel.

---

Avion incorporates latest state-of-the-art engineering and fine craftsmanship into every coach it builds. All systems and appliances function together to provide home-like conveniences for your traveling and camping enjoyment. Like all fine equipment, your Avion requires care and regular maintenance to keep it performing at peak efficiency. A basic understanding of how Avion's systems operate will enable you to accomplish many service and maintenance functions yourself, if you wish.



*John Crean*

Your Avion is protected by Fleetwood's full warranty for a period of one year from date of purchase. See page 104 for warranty information. For more information about your nearest Avion authorized service representative, please call our nationwide toll-free number: (800) 854-4755. In California, call toll-free (800) 442-4804.

Due to variations in the availability of materials, and our continuous program of product development and refinement, Avion Coach Corporation reserves the right to change specifications without notice. All information contained in the Owner's Manual is based on the latest product data available at time of publication. If you have any questions regarding changes that may be incorporated into your trailer, please call the manufacturing plant for details (616) 927-2271.

---

## **Preparation**

Tow Vehicle	2
Accessories	3
Loading	4

---

## **Towing**

Hitching Up	10
Towing Tips	12

---

## **Travel**

When to Go	18
Where to Stay	20
Brief Stopovers	20
Lengthy Stops	21
Travelcade Club	24

---

## **Exterior**

Exterior Identification	28
Care of Exterior Surfaces	30
Features	30
Tires and Wheels	35
Braking System	38
Suspension System	41

---

## **Interior**

Furniture and Features	46
Care of Interior Surfaces	52
Monitor Panel	54
Floor Plans	54

---

## **Systems**

LPG System	60
Fresh Water System	62
Drainage System	68
Electrical System	72

---

## **Appliances**

Refrigerator	82
Range and Oven	86
Microwave Oven	90
Furnace	92
Water Heater	95
Air Conditioner	98

---

## **Maintenance**

Winter Storage	102
Full One Year Warranty	104
Maintenance Schedule	106
Maintenance Record	107
Specifications	108

---

<b>Index</b>	111
--------------	-----

---

# Preparation

---

Tow Vehicle

2

---

Accessories

3

---

Loading

4

---

# Tow Vehicle

There is no substitute for proper equipment when it comes to towing the additional weight of a trailer. Your tow vehicle must be adequately equipped and maintained to insure both safety and continued trouble-free performance.

Proper equipment includes an engine with sufficient power to safely pull your Avion up long grades even under the most adverse conditions, as well as the correct drive and axle ratios, cooling system capability, tires, suspension and electrical system. Your Avion dealer will be happy to discuss tow car specifications with you.

Whether you plan to buy a new car or use your present one for towing purposes, we recommend that you purchase a trailer towing package. A typical package consists of heavy-duty springs, shock absorbers, radiator, alternator and battery. Many new car packages also feature heavy-duty fan and flasher units, and an automatic transmission cooler. Availability of these items may vary with vehicle manufacturer. Tires of the correct size and load capacity to carry the added hitch weight must also be used.

In addition, you should seriously consider installing a load equalizing-type trailer hitch with a friction type sway control, such as those manufactured by Reese Products, Inc. and Eaz-Lift Spring Corporation. This type of hitch spreads the weight of the coach as evenly as possible over all the wheels and axles, as well as providing for somewhat increased driving stability. The friction type sway control provides increased stability, and improves trailer handling during emergency maneuvers and in crosswinds. Always inspect your hitch regularly. Tighten loose nuts and bolts, and immediately repair or replace any cracked or worn parts.

A 2-5/16-inch hitch ball should be mounted on your tow vehicle. The distance from the top of the ball to the ground, measured with tow vehicle unloaded, will differ according to the model of your trailer. At the proper height, and with an equalizing-type hitch correctly adjusted, your Avion will ride level. Although the trailer design permits safe towing even when it is not perfectly level, and your tow car may ride slightly lower at the rear, we recommend that both vehicles sit as level as possible.

If your tow car is equipped with adjustable road-leveling air shocks, the rear wheels may become overloaded. This can be corrected easily by weighting the car with a simulated typical load of passengers and luggage, then resetting the shocks to "level". Record the air pressure for future reference. To be sure you do not exceed the tow vehicle's rear Gross Axle Weight Rating (GAWR), tow vehicle as described in Loading page 4.

**Caution: Follow your vehicle manufacturer's recommendations on load limits, wiring modifications, and hitch and brake controller installation. If you are in doubt, consult your Avion dealer for assistance.**

# Loading

Correct loading of your Avion is necessary to avoid damage to equipment carried inside, as well as to the tow vehicle and the trailer itself. The suggestions below are designed to assure safe loading and to prevent possible overloading of the coach.

## Inside Your Avion

1. Make certain that everything in the trailer is stored properly... especially breakable items.
2. Prepare the refrigerator by wedging rolled-up towels around containers so they will not move or topple. We recommend using square plastic containers with tight-sealing lids for maximum stability and safety. **Do not** leave ice cubes in the freezer compartment unless the refrigerator is operating while you travel. Be sure the travel latch is engaged to prevent refrigerator doors from opening.
3. Latch all drawers, cabinets and closet doors securely.
4. Do not place objects on top of beds while traveling. The vibration of the mattress and springs has a tendency to move everything forward. If the brakes are applied too quickly, items may be thrown to the floor and damaged.
5. Place heavy gear as close to the floor as possible, and forward of the center of the trailer.

**Warning:** Your Avion has been scientifically balanced for even weight distribution. **Do not** add heavy objects such as a motor bike, tool boxes, jacks, etc., to the rear of the coach. This could upset the weight balance, possibly causing instability and excessive sway while towing. If it is necessary to load heavy objects in the trailer **temporarily**, always place them as close as possible to the area either directly above the axles or slightly forward of the axles.

6. **Do not overload.** Refer to **Weights**, page 7, for maximum cargo weight, hitch weight and gross vehicle weight.
7. Do not carry passengers in the coach while it is in motion. It was not intended for this purpose. Furthermore, many states have laws which prohibit this practice.

## Vehicle Weights

Overloading places undue stress on the trailer and can cause it to become awkward and unsafe. Your Avion has been engineered to function at its **Gross Vehicle Weight Rating (GVWR)** when fully loaded with all necessary traveling supplies. Thus, trailer weight and load distribution are major factors in safe and economical operation.

The GVWR is located on a metal certification plate mounted on the road side of the coach near the front. See illustration. Also shown on this plate are the **Gross Axle Weight Ratings (GAWR)**. These are the maximum allowable weights per axle when the trailer is hitched to the tow vehicle. The ratings help you establish the proper weight and balance for efficient, safe towing. Traveling as lightly as possible provides for better fuel economy, decreased engine loads, and ease of handling.

The recommended method for determining whether your Avion is within the prescribed limits is to weigh it **fully loaded**. Public scales for this purpose may be located by checking the Yellow Pages under "Weighing—Public," or by contacting a truck service center.

The following step-by-step procedure should be used for weighing the trailer and tow car. The vehicles must first be properly hitched together and fully loaded for travel, including fresh water tank, water heater, LPG bottles, supplies, gear and passengers.

1. Drive the tow car forward until the **front wheels** are on the scale, and take a reading. **The load on the front wheels must not exceed the tow vehicle front GAWR as specified in the tow vehicle owner's manual or certification tag**

## Vehicle Weighing

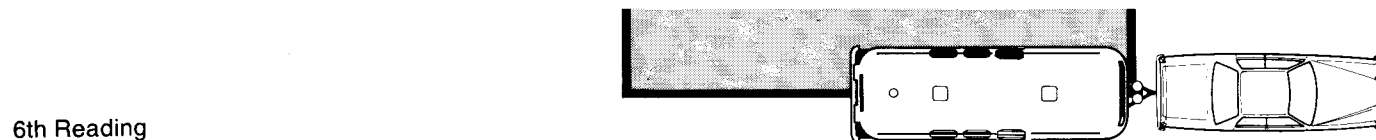
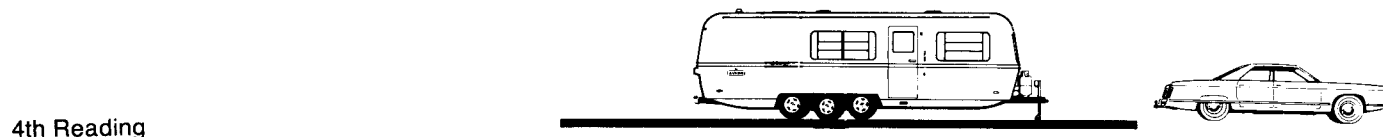
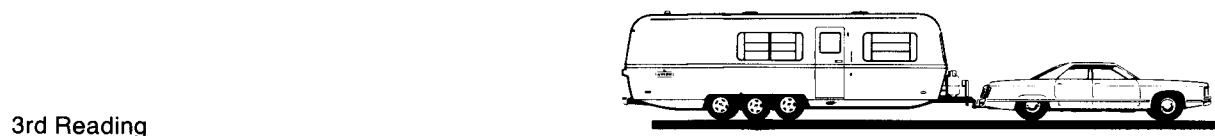
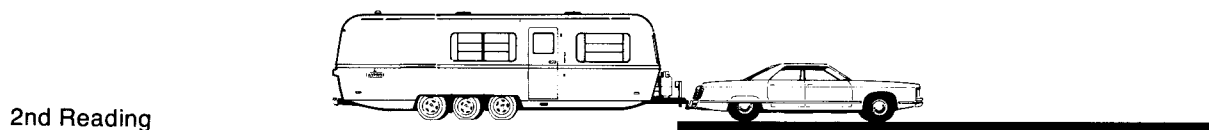
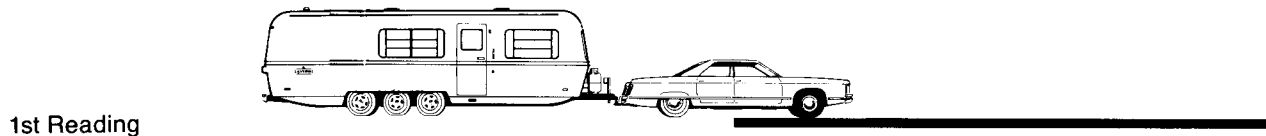

<b>1st Reading</b>	Load on front axle of tow vehicle
<b>2nd Reading</b>	Gross connected tow vehicle weight, including trailer tongue weight
<b>2nd Reading minus 1st Reading</b>	Load on rear axle of tow vehicle
<b>3rd Reading</b>	Total weight of tow vehicle and trailer
<b>3rd Reading minus 2nd Reading</b>	Load on axles of trailer
<b>4th Reading</b>	Gross vehicle weight of trailer
<b>5th Reading</b>	Weight of one side of trailer, while connected to tow vehicle
<b>6th Reading</b>	Weight of opposite side of trailer, while connected to tow vehicle (should nearly equal 5th reading)



2. Pull forward until **both the front and rear wheels** of the tow vehicle are on the weighing platform, and take a second reading. The first figure represents the load supported by the **front axle** of the tow car; the second figure is the **gross connected tow vehicle weight, which must not exceed the tow vehicle GVWR**. The load on the **rear axle** of the tow car is determined by subtracting the first reading from the second reading. The difference, which includes the trailer tongue weight, **must not exceed the tow vehicle rear axle GAWR**.
3. Now drive forward until **both the tow car and trailer** are on the weighing platform, and take a third reading. This figure is the **total weight** of the combined tow vehicle/trailer configuration. To arrive at the trailer's axle load, subtract the second figure (gross connected tow vehicle weight) from this third figure. **The load on the coach axles must not exceed the total of the coach's axle GAWRS.**
4. The **gross weight** of the loaded trailer can be obtained by uncoupling the tow car and driving it off the scale, leaving only the coach on the platform. This fourth reading is your Avion's **Gross Vehicle Weight. It must not be more than the GVWR listed on the certification plate.**
5. Side-to-side weight distribution should be as nearly equal as possible. It can be ascertained by weighing first one side of the trailer and then the other, **while it is properly hitched to the tow vehicle.**

### **Tongue Weight**

The maximum recommended figure for your Avion's trailer tongue weight is 1000 pounds, and should be within 10-15% of coach weight. Trailer tongue weight can be calculated using public scales, or you can determine it at home as an aid to loading using the following method. See photo.

1. Chock all trailer wheels, in front of and behind the tires.
2. Place a lifting jack under trailer tongue rail and raise the coach. Remove the dolly wheel from the jack post.
3. Face the front of the coach and position an ordinary bathroom scale on the ground to the **left** of the trailer hitch jack post and in line with it. The center of the scale should be exactly **two feet** from the centerline of the jack post.
4. Place a block of wood (about the same thickness as the scale) on the ground to the **right** of the jack post, in direct line with the post and the scale. The center of the block should be exactly **one foot** from the centerline of the jack post.
5. Position a short piece of pipe on the center of the scale and another on the center of the wood block, both at right angles to the front of the trailer.
6. Lay a 4' x 4" x 4" piece of wood across the two pieces of pipe. This cross member should be exactly under the jack post.
7. Lower the trailer tongue until the jack post rests on the cross member and is fully supported by it.
8. Level the trailer front and rear.
9. Check the scale and **multiply the weight reading by three** (the total number of feet along the cross member between the wood block and the scale). If the weight exceeds the limit of the bathroom scale, simply increase the distance between scale and jack post by one-foot increments until a reading is obtained (you will also have to use longer cross members to span the increased dimension). **Always remember to multiply the weight reading by the exact number of feet between the bathroom scale and the wood block.** The resulting figure is the **trailer tongue weight**. This method can also be used to weigh your supplies while loading, in order to develop a well-balanced pattern.

### *Tongue Weight*

### **Selecting a Hitch**

We recommend the use of a top-grade load-equalizing hitch similar to the types manufactured by Reese Products, Inc. and Eaz-Lift Spring Corporation. A properly coupled load-equalizing hitch divides the trailer's tongue weight into three parts and saves wear and tear caused by uneven weight distribution. Approximately one-third of the weight is supported by the trailer's axles and the other two-thirds are supported by the tow car's front and rear axles. **If any axle weight rating is exceeded, equalizer settings must be changed and/or cargo moved or eliminated, to bring all axles within prescribed limits.** Periodically reweigh your coach and tow car to guard against overloading.

### **Tow Vehicle Tire Pressure**

Correct loading also means correct tow car tire pressure. An equalizing hitch increases the load on each wheel of the tow vehicle, and additional tire pressure is required to compensate for the extra burden. Refer to your tow car operating manual for instructions, and in no case exceed the maximum pressures shown on the tire sidewalls. The pressure must be measured when the tires are cold. Adjusting tire pressure when the tires are warm will cause under inflation and possible tire failure.

## Proper Load Distribution

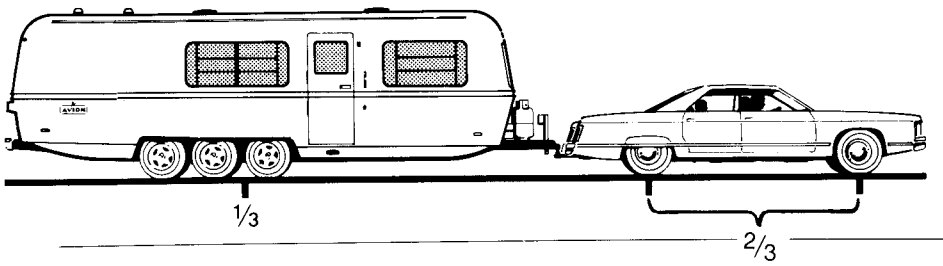

## Improper Load Distribution

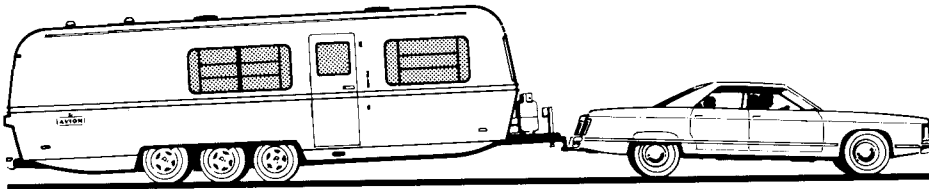

Hitch Too High

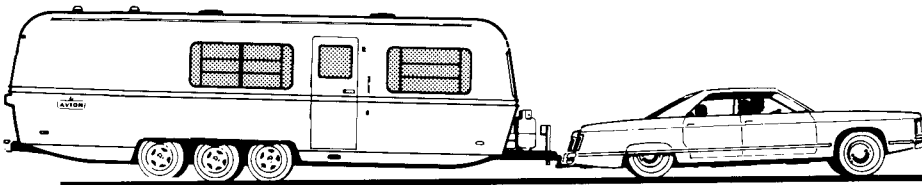

Hitch Too Low

## Trailer Weights and Ratings

Model	Gross Vehicle Weight Rating (GVWR)	Gross Axle Weight Rating (GAWR)	Cargo Capacity
V	9500	2950 per axle (8850 total)	2200
P	8550	3940 per axle (7880 total)	2200

# Towing

Hitching Up

10

Towing Tips

12

# Hitching Up

Hitching up your Avion in preparation for travel will become routine procedure with experience. You should follow the recommended step-by-step method the first time and every time you hitch up the trailer. Additional measures to observe in preparing the coach for travel after a lengthy stop are covered in the **Travel** section, page 22.

## Hitch-Up Procedures

1. Raise the front of the trailer with the post jack.
2. Back your tow car into position, with the hitch ball under the trailer hitch socket. If you are working alone, we suggest using a hook-up mirror to give you a view of the trailer hitch while backing up.
3. After the hitch ball has been positioned under the hitch socket, make sure the locking lever has been raised and pushed to the rear, then lower the front end of the trailer onto the hitch ball. Rock the tow vehicle back and forth several times to seat the socket and ball fully, then place the ball lock into position. The lock should be secured by inserting a hitch safety pin or small lock through the hole immediately to the rear of the latch.
4. Raise the front of the coach again (the tow car will come up with it), and attach the leveling bars. When the trailer is then lowered, the tow vehicle should be slightly down at the rear. If it is high in the rear, stays level or is excessively down at the rear, adjust the leveling bars as needed.

If the leveling bars are adjusted too loose, weight does not transfer to the tow vehicle front wheels, possibly causing poor handling and rear axle overload. Adjusting leveling bars too tight transfers excessive weight to the tow vehicle front wheels causing poor handling, loss of rear wheel traction and possible trailer jack knifing.

When properly leveled, the hitch load is equally distributed for optimum steering control and balance, with a little less than one-

third of the weight on the tow vehicle's front wheels, a little more than one-third on its rear wheels, and approximately one-third on the trailer's wheels. The hitch bars will have a noticeable arc or "bowing" effect when it has been correctly installed. You can save time on subsequent hitch-ups by marking the appropriate chain links with tape, so you will know exactly how high to raise the bar.

5. Remove the dolly wheel or any blocks that may have been used under the post jack, and retract it to the highest position. Hook up electrical connections from tow vehicle to trailer and anchor the break-away switch cable to the tow vehicle hitch frame.
6. Your Avion is equipped with two safety chains that are attached to the trailer tongue. Cross the chains under the hitch and thread them through their respective eyes on the hitch, adjacent to the side of the tow car's centerline. Each chain should then be hooked back through itself, using the special terminal links provided. Adjust each chain length so that it is as short as possible while still permitting full turns without becoming taut. Both chains should have the same amount of slack, and they should be short enough to hold the trailer tongue off the ground in the event it becomes uncoupled.
7. Install and tighten the friction type sway control.
8. Inspect tire condition on trailer and tow car, and make it a practice to check air pressure on a regular basis.
9. Recheck all previous steps, and then pull forward 20 or 30 yards to test the brakes.

## Final Check List

- Wheel lug bolts tight
- Coupler latched and secured with hitch safety pin
- Safety chains secured to tow car
- Break-away switch cable attached to tow car hitch frame
- 7-way connector plugged into tow car electrical system
- Sway control installed and tightened.
- Trailer batteries connected and charged
- Jacks stored and blocks removed
- Trailer running lights working
- Brake controller operating
- Mirrors adjusted

- Hitch Post Jack
- Break-Away Switch Cable
- Locking Lever & Safety Pin
- Coupler
- Dolly Wheel
- Electrical Connector
- Leveling Bars
- Sway Control
- Safety Chains
- Hitch

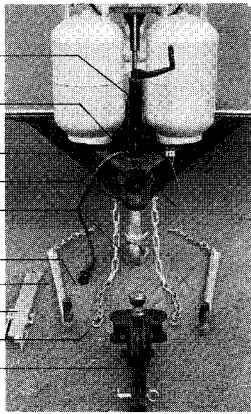

*Hitching Up Equipment*

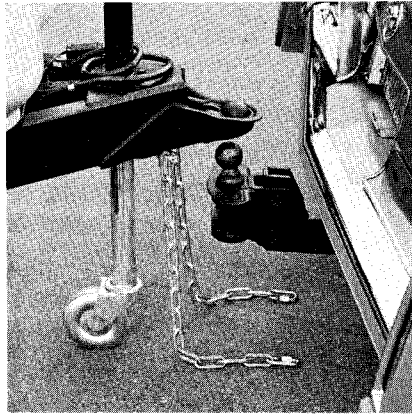

*1. Extend post jack, back up car.*

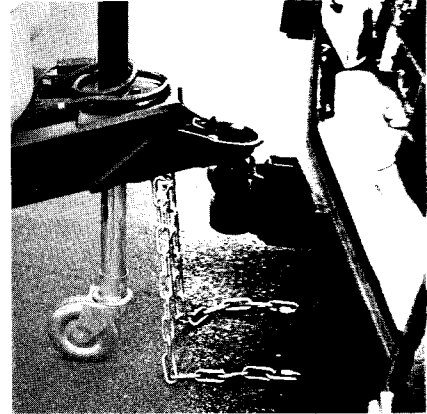

*2. Lower trailer, insert safety pin.*

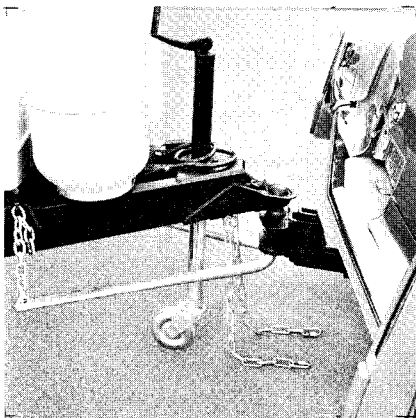

*3. Raise trailer and car, attach bars.*

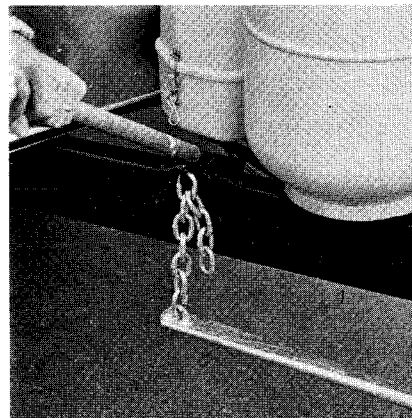

*4. Adjust leveling bars.*

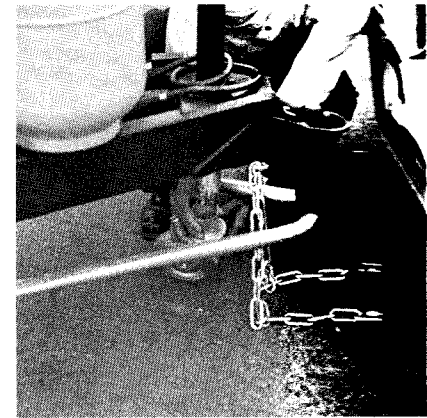

*5. Remove dolly wheel.*

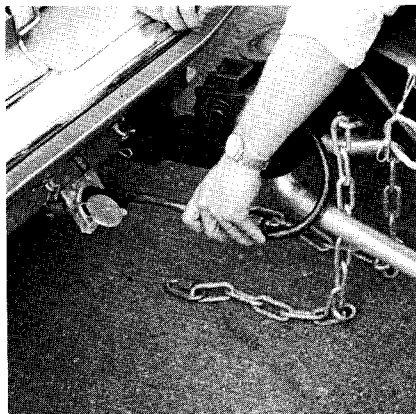

*6. Hook up electrical connector.*

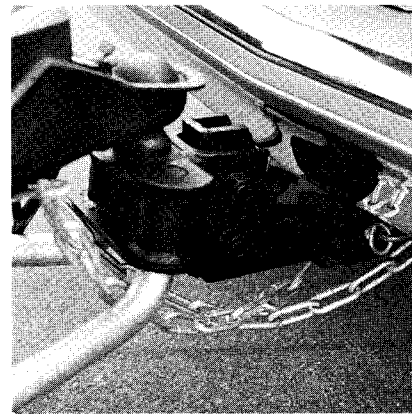

*7. Connect safety chains.*

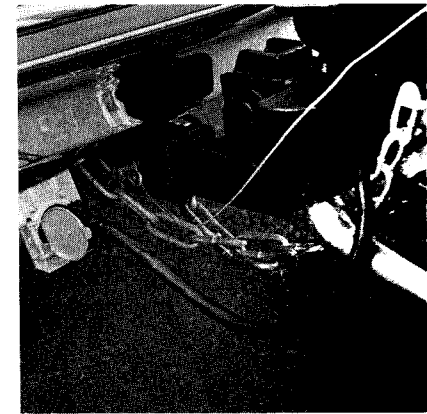

*8. Connect break-away switch cable.*

# Towing Tips

A thorough knowledge of the proven driving techniques used in trailering will assure many years of safe, carefree operation of your Avion. We urge you to observe these towing tips whenever traveling.

## Equipment

- 1. Rear View Mirrors.** Your tow car can be outfitted with various types of outside mirrors. Most states require one mirror extending from each side of the tow car to provide the driver with a clear view when passing and when being passed. Check for specific laws in the states where you plan to travel. Mount and adjust outside mirrors to show the side of your trailer and as much of the adjacent rear and side views of the road as possible. Make it a habit to check all rear view mirrors frequently.
- 2. Brake Controller.** Your Avion's electric brakes are activated by a brake controller installed in the tow car. When the car brake pedal is depressed, the controller **automatically** applies the trailer brakes at the same time as, or slightly before, the car brakes engage. Select a brake controller that can also be operated **manually** in emergency situations to help correct any excessive sway of the trailer. For more information about the operation of the brake controller, see **Brakes**, page 38.
- 3. Lights.** Inspect all exterior lights on trailer and tow car periodically, to be certain you can see and be seen.
- 4. Emergency Equipment.** Before starting any trip, always have on board wheel blocks, lifting jacks, flares, tool kit, flashlight with fresh batteries, first aid kit, and a fully-charged fire extinguisher.

## Road Courtesy

- 1. Practice Means Proficiency.** Save time and avoid frayed nerves for yourself and other drivers on the road. Learn the feel and handling characteristics of your new Avion by practicing **before** you head into city traffic or onto the highway. A large, empty parking lot is ideal for practicing turns, stopping, backing up, and parking, until you feel comfortable and competent.
- 2. Turning.** Your Avion coach has a **tighter** turning circle than the tow car, which means you must make **wider** turns than you are accustomed to with your car alone ... especially in city driving and when negotiating sharp turns. You can visualize exactly how the two vehicles move in relation to each other by examining their tire tracks. See illustration.
- 3. Entering Traffic.** Inspect your brakes, tires and hitch before getting underway. Check traffic in all directions, then signal your intention to pull away. When clear, start slowly while observing the trailer in your mirrors, then move carefully into the appropriate lane.
- 4. Passing.** When passing another vehicle, remember that your tow car will accelerate more slowly than usual because of the added weight of the trailer. Allow ample passing time and distance, and once past the other vehicle, allow for trailer length clearance before returning to the original lane. Use your outside rear view mirrors to assure safe maneuvering.
- 5. Towing Speed.** Probably the greatest factor in safe, pleasant towing is maintaining reasonable vehicle speed. Lowering of speed increases trailer towing stability and reduces emergency stopping distances. If you are new to travel trailering, substantially reduce your driving speed while towing. With experience, you will be able to determine the maximum safe speeds for all towing conditions. Slower speeds will also increase fuel economy.

6. **Towing Stability.** Speeds, cargo weight distribution, and wind conditions are the principal factors affecting trailer towing stability. Reduced trailer towing stability can be recognized by the tendency of the trailer to sway from side-to-side after quick course changes, in cross winds, or while being passed by trucks or buses.

If the trailer begins to sway strongly from side-to-side, make as little steering corrections as possible. Using the hand lever on the trailer brake controller, firmly apply the trailer brakes to pull the trailer straight behind the tow vehicle, and reduce speed. (NOTE: Brake pedal mounted controls may not allow for independent operation.) Do not attempt to stop the trailer swaying by making quick steering changes or by forcefully applying the tow vehicle brakes.

If a reduction in trailer stability has occurred, stop as soon as possible. Correct the situation by shifting weight forward in the trailer. If it is not practical to stop immediately, reduce speed until the trailer stops swaying.

Since cargo weight in the rear of the trailer can reduce towing stability, avoid storing heavy objects in the rear of the trailer or on the rear bumper. Empty waste holding tanks before traveling whenever possible.

Heavy cross winds, particularly gusts below canyons or at other exposed locations, can cause excessive trailer swaying or loss of control. Under these conditions, reduce speed until control can be maintained.

Equalizing hitches improve towing stability and should be used on all travel trailers except 5th wheel trailers. In addition, sway control devices are offered by most hitch manufacturers that will help reduce swaying, and will improve trailer handling during emergencies or in crosswinds. Be sure to follow the hitch and sway-control manufacturer's instructions. Correct use of these devices will increase stability, but should not be considered a substitute for prudent speed, proper cargo loading, safe weather conditions, and towing experience.

### Turning

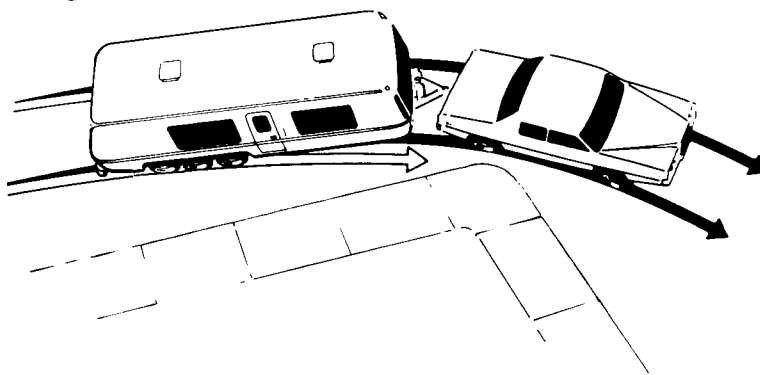

### Passing

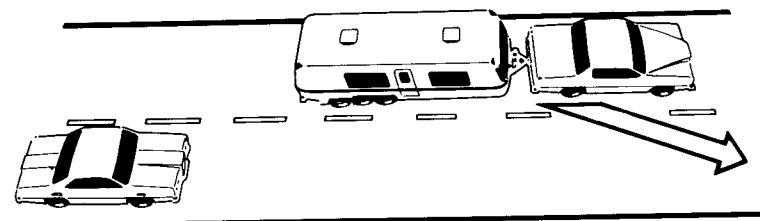

### Being Passed

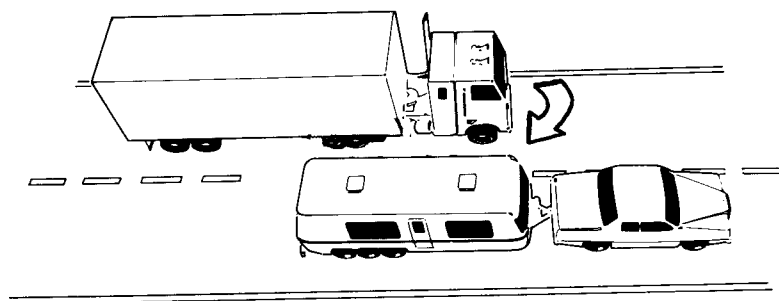

## Backing Up

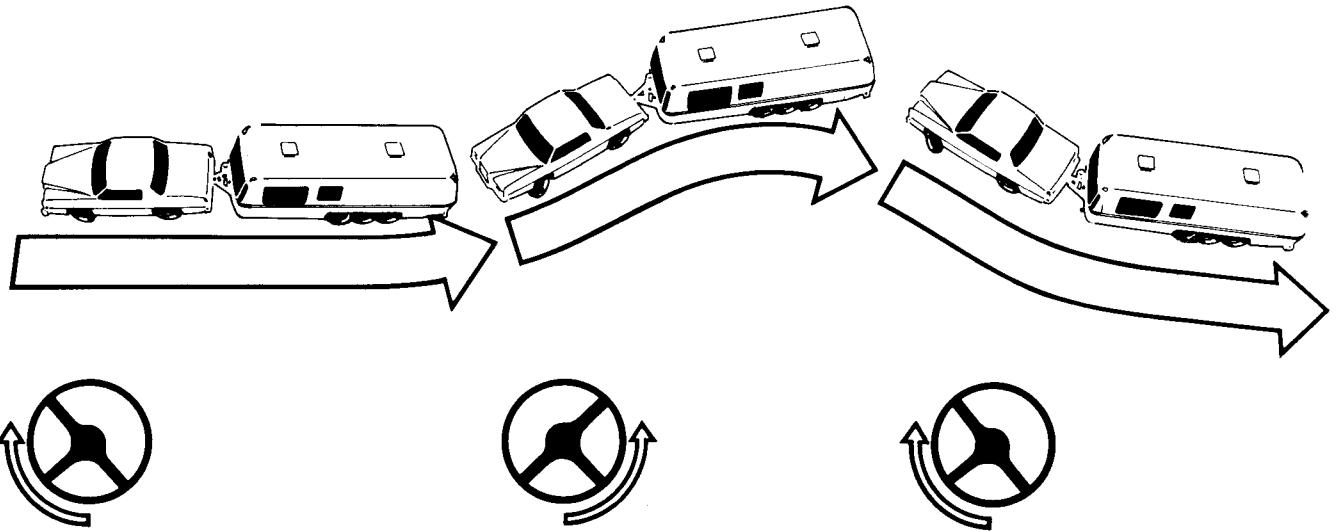

14

Small but sudden course changes can occur when a vehicle towing a travel trailer is passed from the rear by a large flat-fronted vehicle such as a truck or bus. These course changes happen when the side wind from the flat front blows against the side of the trailer. As the truck front passes the rear of the trailer, the tow vehicle will tend to turn away from the truck, and as the truck front passes the trailer wheels, the tow vehicle will turn back toward the truck.

When a large flat-fronted vehicle passing from behind causes your vehicle to change course make as little steering correction as possible, remembering that the tow vehicle will be turned back toward its original course as soon as the truck front passes the

trailer wheels. Avoid quick steering corrections that can inadvertently magnify these course changes and start trailer swaying.

7. **Passing.** When passing another vehicle, remember that your tow vehicle will accelerate more slowly than usual because of the added weight of the trailer. Allow for clearance of the trailer before returning to the original lane. Use your outside rear view mirrors and proper turn signals to assure safe maneuvering.

8. **Stopping.** The increased weight of the car-trailer combination requires greater stopping distances. Maintain at least twice the normal stopping distance while towing your trailer.

9. **Backing Up.** Here is an easy way for new trailerists to remember the way to turn the steering wheel when backing a trailer. Place your hand at the bottom of the steering wheel. To turn the trailer to the left, move your hand to the left (turn steering wheel clockwise). To turn the trailer to the right, move your hand to the right (turn the steering wheel counterclockwise). Your car should go the opposite way that you want the trailer to turn. In time, and with a little practice, backing will be accomplished with little effort. Always be aware that you have poor visibility to the rear. Someone standing outside at the rear of the trailer guiding your actions will assure safe backing.



## Weather and Road Conditions

**1. Towing in Hot Weather.** High outside temperature alone is usually insufficient to cause overheating of your tow car. However, additional factors such as pulling up a long or steep grade, slowing after sustained high-speed driving, or idling in traffic, can cause a temporary cooling system overload. When this happens, turn off the air conditioning in your car and pull into a turnout or rest stop as soon as possible. With the transmission in "neutral" and the parking brake engaged, step on the accelerator to increase engine idling speed. Run engine at fast idle for five minutes. Also open the hood to check for cooling system leaks, broken fan belts and other possible malfunctions, such as a broken thermostat.

**Caution: Do not check radiator coolant level while engine is hot. Automobile cooling systems operate under high pressure, and the radiator cap should never be removed while engine is overheated.**

If no problems are evident, the radiator fan will reduce cooling system temperature sufficiently to have you underway again in a few minutes. Drive slowly for several minutes before resuming normal speed. If overheating recurs or persists, have it corrected at the earliest opportunity.

**2. Towing in Inclement Weather.** Do not downshift to slow the trailer and tow car on wet or icy pavement. The rear wheels may skid if you do so. In the event of a skid, switch your brake controller to **manual** and gently apply the **trailer brakes only**, in order to help realign the vehicles.

Road salts used for snow and ice removal may be injurious to the trailer finish. You can prevent such damage by waxing the surface prior to exposure and washing it immediately after exposure. See page 30 for additional information on care of exterior surfaces.

**3. Towing in Wind.** Heavy cross winds, particularly gusts below canyons or at other exposed locations, can cause excessive trailer swaying or loss of control. Under these conditions, reduce speed until control can be maintained.

If the trailer begins to sway strongly from side-to-side, make as little steering corrections as possible. Using the hand lever on the trailer brake controller, firmly apply the trailer brakes to pull the trailer straight behind the tow vehicle, and reduce speed. (NOTE: Brake pedal mounted controls may not allow for independent operation.) Do not attempt to stop the trailer swaying by making quick steering changes or by forcefully applying the tow vehicle brakes.

**4. Towing Downhill.** Shift the transmission into low gear, if possible. Engine compression will then act to slow both vehicles. If speed begins to increase again, lightly pump the brakes several times. **Do not ride the brakes or pump them forcefully.** Take dips and road irregularities slowly and carefully. Remember: Your Avion's wheels must clear these road hazards, too.

**5. Parking on Hills.** Chock all trailer wheels, leave the transmission in gear, and apply the hand brake on your tow car. **Do not use trailer brakes for parking.** Always turn the front wheels of the tow car into the curb to prevent possible runaway.

**6. Towing in Mud and Sand.** Use your forward momentum with as little additional power as possible. Roll into the tracks of the vehicle ahead in the highest gear you can maintain without the engine lugging. If your rig should become mired, **do not** unhitch the coach. Call for road service and have the vehicles pulled out together.

**7. Towing on Gravel or Dirt Roads.** Plan your route to avoid driving long distances over inferior roads. Stones and other debris thrown onto the front of your Avion by the tow car's rear tires can scratch or dent the aluminum surface. If you find it necessary to travel under such conditions, we suggest taping heavy sheets of plastic or cardboard to the lower front end portion of the coach.

**8. Towing in Traffic.** On two-lane roads, other vehicles will rapidly line up behind you unless normal speed is maintained. Safety and courtesy dictate that you signal, pull into a turnout, and allow others to pass. **Avoid pulling onto shoulders except in cases of emergency.** On freeways, expressways and other multi-lane roads, pick the lane you want and stay in it. You should not drive in the high-speed (inside) lane when pulling a trailer. Always check mirrors and exercise additional caution when entering or exiting freeways, or when changing lanes.

# Travel

When to Go	18
Where to Stay	20
Brief Stopovers	20
Lengthy Stops	21
Travelcade Club	24

# When to Go

Trailer is much more than a summertime activity. The true enthusiasts enjoy traveling year-round to experience the changing seasons and take advantage of wide-open highways, uncongested campsites, uncrowded tourist attractions and, in many instances, off-season rates.

## Insulation

Your Avion is truly an "all-weather" trailer, thanks to a combination of sophisticated climate control systems and effective insulation. Avion utilizes urethane foam... the most efficient and versatile material on the market today. The insulation capability of urethane is almost twice that of the next best product, offering both low thermal conductivity and low moisture vapor permeability.

Avion constructs its coaches with the insulation as an integral part of the walls, rather than using batting or sheets of material. First, the outer skin is assembled, then foam is sprayed into all interior cavities, and finally the inner wall panels are attached. This method of construction not only provides better insulation, it also results in more rigid walls, making the aluminum skin less susceptible to dents.

Even the floor of your Avion trailer is fabricated with extra care. A full 1½ inches of rigid foam insulation is sandwiched between two layers of plywood flooring, and finished with sturdy sheet metal on the underbelly.

## Cold Weather Traveling

Avion trailers have been designed to make winter trips enjoyable and comfortable, even under prolonged sub-freezing conditions. For maximum comfort, simply take the kind of steps you would to keep your home warm during cold weather.

- 1. Keep your trailer heated.** Avion is equipped with a forced air furnace that operates equally well whether the coach is stopped or moving. Leave the heat on at all times to protect water systems. It is also more economical in the long run to maintain a constant "room temperature" than to warm the trailer from a cold start. All **internal** doors and folding partitions should be kept slightly ajar when the coach is occupied, to assure free air circulation throughout the interior.
- 2. Carry ample LPG.** Because of increased fuel consumption during cold weather, you should always have a sufficient supply on hand when you need it.
- 3. Use outside electricity.** The more external power you use, the less the drain on trailer batteries. For extended stays, especially, locate a 110-volt electrical hook-up. If none is available, you must use internal battery power, but sparingly. Avion's self-contained electrical system is designed to operate many hours on its fully-charged batteries. When recharging is necessary, find an external 110-volt power source or run your tow vehicle's engine at fast idle. One hour of recharging will give you about four hours of available power. See **Battery** section, page 78.

**Caution: Carbon monoxide fumes from the car engine exhaust can be potentially dangerous. Whenever the trailer batteries are being charged by the tow vehicle, be sure the windows in the front end of the coach are closed to prevent fumes from entering. Do not run the engine in a confined area.**

**4. Guard against heat loss.**

Your Avion trailer has been constructed with extensive foam insulation to retain as much of the internal temperature as possible, but a few additional precautions will result in even greater heat retention. Driving during sunlight hours will take advantage of solar radiation on the trailer and avoid the heat-robbing effects of cold winds. Draw all window shades and drapes to prevent heat loss through the glass, and keep the exterior door closed whenever possible.

**Caution: In sub-freezing weather, insulate the external water and solid waste lines to prevent possible damage.**

### ***Warm Weather Traveling***

Trailing during the summer months will be a more pleasureable experience if you observe these travel tips.

- 1. Park in shady areas whenever convenient.** This is especially important during midday hours, when the sun's rays are strongest. Under most conditions, the same superior insulation that keeps your Avion warm in the winter will keep it comparatively cool during the summer.
- 2. Keep roof vents open slightly to maintain fresh air circulation inside.** The vents have been designed to remain open even when it rains. While traveling, crank open only the **rear** portion of the vents. All windows should be kept tightly **closed** while traveling, in order to avoid creating cross-ventilation air drafts that can pull in dust and dirt while the coach is in motion.

- 3. Watch your tow car's cooling system closely.** Remember, the engine is pulling a heavier load than normal, causing it to run at higher temperatures, even with special heavy-duty components. Overheating is most likely to occur while driving in stop-and-go traffic or pulling up long or steep grades. Driving in hot weather under such conditions tends to magnify the possibility of overheating. See **Towing Tips**, page 12.

- 4. Plan ahead.** Your daily itinerary should take into account the higher traffic volume during summer months. This can be offset somewhat by taking advantage of longer daylight driving hours. It is also prudent to write or phone ahead for campsite reservations during vacation seasons. If you intend to enter state and national parks, you may find it more economical to purchase season permits where available, rather than paying a fee every time you visit a controlled area. Also secure proper hunting and fishing licenses and observe the local seasons and limits.

---

## Where to Stay

Your Avion provides you with a home environment virtually any place you travel. You can park in safety and comfort wherever you choose, as long as the site is relatively level and firm, and camping does not violate local ordinances. Once off the highway, you will encounter almost unlimited possibilities by using a little imagination and creative exploration.

Public and private campgrounds and trailer parks offer sites to satisfy many differing tastes and needs. Some have swimming pools, restaurants, general stores, playgrounds, sports areas, outdoor cooking facilities, cable television hook-ups, and just about any of the other conveniences of a modern resort hotel. Many sites offer complete facilities for power, water and waste disposal hook-up, while others have more primitive accommodations (usually national and state parks, forests and monuments). Because your Avion coach is completely self-contained, you can park in comfort regardless of the area you select.

We suggest that you pick up any of the campground guides available

through automobile clubs, the National Park Service, or state and local tourist bureaus. These guides provide detailed information on locations, facilities, accommodations, activities, periods of operation, and fee schedules.

If you prefer not to stay in a campground, simply ask the local residents when you arrive in the general area where you plan to stop for the night. Also check with the police department, sheriff, ranger station or chamber of commerce. These people know the area and they are usually eager to help. If public land is not available, farmers will sometimes allow you to stay on their property, and local merchants or service station operators may give you permission to use their parking lots overnight.

Write or telephone ahead, whenever possible, and you will know what is likely to be available. If you are intent on staying at trailer parks or campgrounds, we recommend that you make advance reservations, especially during vacation seasons.

20

---

## Brief Stopovers

Select a parking spot and position the trailer. If the site is relatively level, it is not necessary to use blocks or stabilizing jacks. **However, you should always chock the wheels and lower the post jack.** This will ease the pressure on the tow car's suspension and give the coach greater stability. If the only available site is on an incline, park facing **down** the slope. This will make it easier to level the trailer.

It is not necessary to hook-up to outside power and water for overnight stops, since your Avion is a completely self-contained unit. The refrigerator can operate on the trailer's LPG system, as well as from available 110-volt external power. Light the refrigerator pilot if you will be running it on LPG. Also light the range and oven pilots if you plan to use the oven. The water heater and furnace operate by electronic ignition and thus have no pilots.

That's all there is to it! When stopping for only one or two nights, it is unlikely that you will run down the batteries, exhaust the fresh water supply, or fill the rinse water and solid waste tanks. Just relax and enjoy your stay. There is not even a need to unhitch your tow car... unless you want to drive into town or go sightseeing. Whatever you choose to do, it's a nice feeling to know your luxurious accommodations are prepared for the night.

# Lengthy Stops

Camping for an extended period requires a more complete setup, in order to utilize the trailer's full capabilities. Observe the following procedures.

1. **Select and prepare the site.** Look for a parking area that is as level as possible, but if you do find it necessary to select an incline, make certain the vehicles face **downhill**. Always carry a shovel and some boards to assist you in preparing the site. They come in handy for lowering bumpy areas and elevating ground depressions, which can cause the coach to lean.
2. **Check trailer for level.** Use a carpenter's or spirit level to determine whether the coach is on a horizontal plane. The level should be placed on top of a counter inside or on the A-frame of the trailer tongue. If leveling is required, it should first be done from side-to-side and then from front-to-rear. See Illustration, page 23.
3. **Level from side-to-side.** To bring the low side of the trailer up to level, place 4'x6"x2" boards (additional board length is necessary for triple axle models) on the ground where the low-side trailer wheels will rest, then drive the coach onto this "ramp" until the wheels are centered. We suggest tapering the ends of the boards so that the tires roll onto them easily. Chock all wheels to prevent the coach from moving. Do not attempt to level the trailer by digging holes for the high-side wheels.
4. **Level from front-to-rear.** Uncouple the vehicles and adjust the trailer hitch jack post up or down until the trailer is level.

5. **Position stabilizing jacks.** If blocks or stabilizing jacks are used to steady the coach, they should be placed under the frame at the front and rear. Any additional jacks that may be needed for leveling on extremely bumpy terrain must be positioned **under the main frame rails only**. Use heavy-duty lifting jacks for this purpose. If your Avion is equipped with the optional stabilizing jacks, they are permanently attached to the trailer for ease and convenience.

**Caution: Stabilizing jacks are not designed to support the weight of the trailer; that is the job of the tires. The jacks should be extended only enough to support the frame and hold it firm. Never use them for lifting the coach.**

6. **Hook up the utilities.** The water intake line and 110-volt electrical cable are located in a locked compartment on the road side at the rear. Open the hinged access cover and pull out the water hose and power cable far enough to reach the hook-up couplings, then connect them. For special instructions on grounding the power cable, refer to **Electrical** section, page 72. You can close the access cover to keep out dirt by seating the water and power lines in the built-in, adjustable-length slots. Connect the sewage and rinse water outlet hose to the outside sewer hook-up. The outlet is located behind a hinged door on the road side of the coach, behind the wheels. Drain rinse water holding tank and leave valve open. Disconnect hose from sewage outlet, swivel the sewage outlet down, swing door up and latch it, and reconnect sewer hose to the outlet. See **Drainage** System, page 68.

**Important:** If outside utilities are not available, regularly check the Monitor Panel for condition of batteries, fresh water supply, and solid waste and rinse water holding tanks. Service them as required.

7. **Turn on LPG.** Open the gas valve, then light the pilots on your refrigerator (if operating on LPG). See **Appliances** section.
  8. **Raise television antenna.** Raise the roof-mounted TV antenna, and adjust for the best reception. You may prefer to use the cable television hook-up, if this service is available at your campsite. Use the terminal housed inside the 110-volt power cord compartment, and switch your TV lead-in from the "TV Antenna" jack to the "Cable TV" jack. See page 33.
  9. **Recharge batteries.** Extended stays utilizing internal power place a burden on the trailer's storage batteries, so conserve electricity whenever you can. The on-board system will operate for many hours on fully-charged batteries. To recharge, run your tow car engine at fast idle. One hour of recharging will provide about four hours of electrical current. Be sure the 7-way connector is hooked up between trailer and tow car before charging.
3. Turn off the LPG supply valve and all pilot light valves on refrigerator, range and oven.
  4. Store all gear as outlined in **Loading** section, page 4.
  5. Close all windows (close roof vents or adjust for travel, if desired; page 48), lower the optional television antenna and lock the main door. Fold the step into its "traveling" position under the coach. Retract the optional front and side awnings and latch them securely.
  6. Retract or remove the stabilizing jacks or blocks from underneath the trailer, hitch up the vehicles for travel, and unchock the wheels. Do not forget any leveling ramps that might have been used.
  7. Clean up all litter that accumulated during your stay. You should leave the area in as good condition as when you arrived. Campers appreciate each other's consideration.

**Caution: Carbon monoxide fumes from the car engine exhaust can be potentially dangerous. Whenever the trailer batteries are being charged by the tow vehicle, be sure the windows in the front end of the coach are closed to prevent fumes from entering. Do not run the engine in a confined area.**

### **Leaving the Campsite**

Preparations for departure should follow this step-by-step procedure to assure that nothing is overlooked.

1. Disconnect power cord and water hose from the outside hook-ups and stow. Also disconnect cable TV, then close and lock compartment.
2. Drain solid waste and rinse water holding tanks and secure dump valves. Disconnect sewer hose from utility hook-up and trailer sewage outlet, flush with clear water, and stow in hinged compartment located behind the rear bumper. Swivel sewage outlet up, replace outlet cap, and latch access door. See **Drainage** section, page 68.

### **Waste Disposal**

Stop at a sanitary dumping facility if you have used the internal water or waste holding systems for an extended period without being connected to a sewer line. Many service stations and roadside rest stops provide public facilities designed for discharging rinse water and solid waste holding tanks and taking on fresh water. Acquire a booklet listing available stations in the areas where you will be traveling. For detailed information on emptying the rinse water and solid waste holding tanks, see **Drainage** section, page 68.

### **Final Check List**

- 110-volt power cord disconnected
- Water hose disconnected
- Sewer hose disconnected
- Windows closed
- Roof vents closed
- TV antenna retracted
- Refrigerator doors locked
- Storage compartments closed and locked
- Interior lights off
- LPG appliances off
- Folding step retracted
- Main door locked
- Wheel lug bolts tight
- Coupler latched and secured with hitch safety pin
- Safety chains secured to tow car
- Break-away switch cable attached to tow car hitch frame
- 7-way connector plugged into tow car electrical cable
- Trailer batteries connected and charged
- Jacks stored and blocks removed
- Trailer running lights working
- Brake controller operating
- Mirrors adjusted
- Side and front window awnings up and latched

## Trailer Leveling

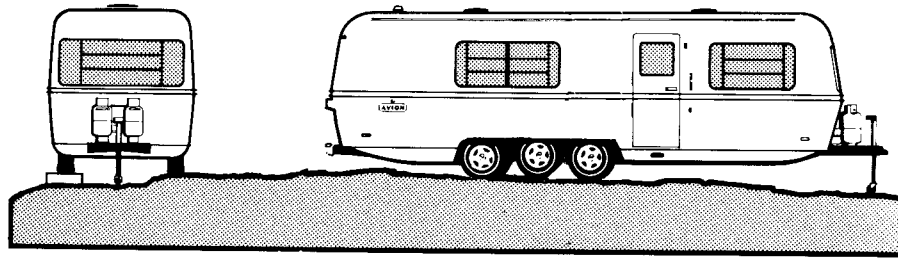

Step 1. Side to Side

Step 2. Front to Rear

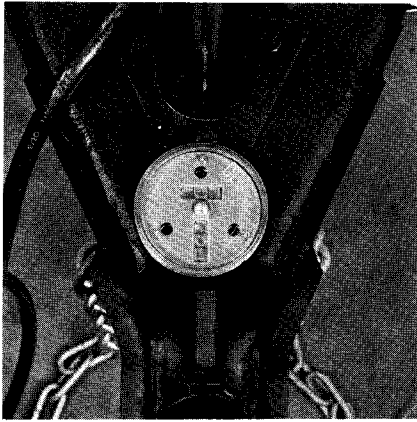

Spirit Level

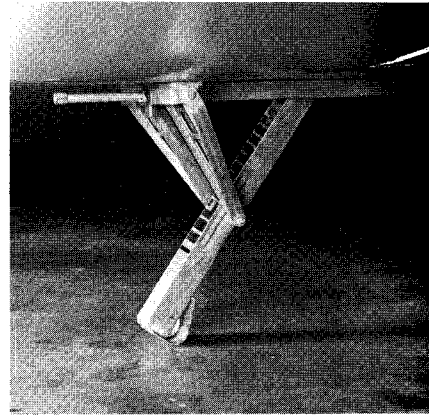

Stabilizing Jacks

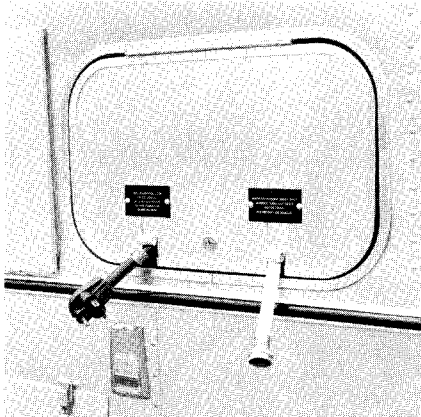

Utility Connections

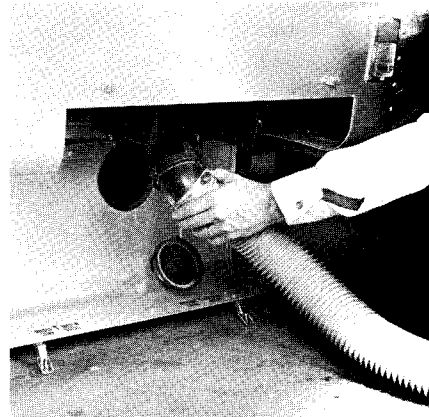

Sewage Hose Connection



---

# Avion Travelcade Club

New travel horizons will be open to you through the Avion Travelcade Club... a private, non-profit organization with a membership limited to Avion owners.

The club brings together families of different ages and diverse backgrounds who share interests common to all trailering enthusiasts: Love of the outdoors, the urge to travel, and a spirit of adventure.

Club gatherings foster goodwill and provide companionship, enjoyment, recreation, and the opportunity to make new and lasting friendships.

## Organization

More than 3000 families belong to the Avion Travelcade Club worldwide. There are 35 separate units in the United States alone, each representing a state or larger area. These units are grouped geographically into larger entities to allow for efficient coordination of activities.

Avion owners who belong to their state units automatically receive membership status in the International Avion Travelcade Club, as well, and are welcome to participate in the rallies of any other unit.

## Activities

Club programs include unit rallies, travelcades and international rendezvous assemblies.

**1. Unit Rallies.** Each unit holds at least two rallies per year, usually in the spring and fall. They generally take place over long weekends and in locations easily reached by unit members. Other units hold monthly rallies. Unit officers are elected by the membership at the annual fall gathering.

- 2. Travelcades.** A travelcade is an organized trip over a predetermined route, for sightseeing and leisurely travel. Local units sometimes stage occasional travelcades lasting from a few days to two weeks, while regional, national and international travelcades may run several weeks and include trips to neighboring states, Mexico or Canada. Each is under the leadership of a travelcade director to assure a safe and enjoyable experience.
- 3. International Rendezvous.** At least three of these large-scale rallies are held each year, in the north during the summer and the south during the winter. They run 4-5 days and are sometimes staged in conjunction with an international travelcade. International officers and regional district governors are elected by the membership at these events.

Avion travelcades are the ideal means of traveling for those who are hesitant about making long trips alone. Travelcades offer security in addition to the fun and fellowship of traveling together and participating in group activities.

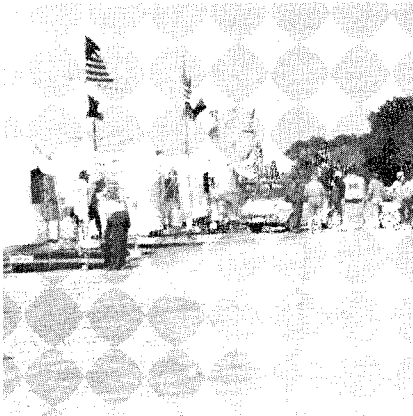

*International Rendezvous*



*Club Insignia*

### **Membership Information**

Members of the Avion Travelcade Club receive their own individual registration number decal for the coach, as well as Travelcade Club insignia and unit name crescent decals for the coach and car windshield. Decals are also furnished showing participation in each international travelcade.

Every member also receives a subscription to the monthly Avion Travel News and a yearly directory of membership, club bylaws, and other information.

For details on membership and dues, ask your Avion dealer for the descriptive brochure and the name and address of your local unit secretary.

# Exterior

---

Exterior Identification	28
Care of Exterior Surfaces	30
Features	30
Tires and Wheels	35
Braking System	38
Suspension System	41

---

# Exterior Identification

28

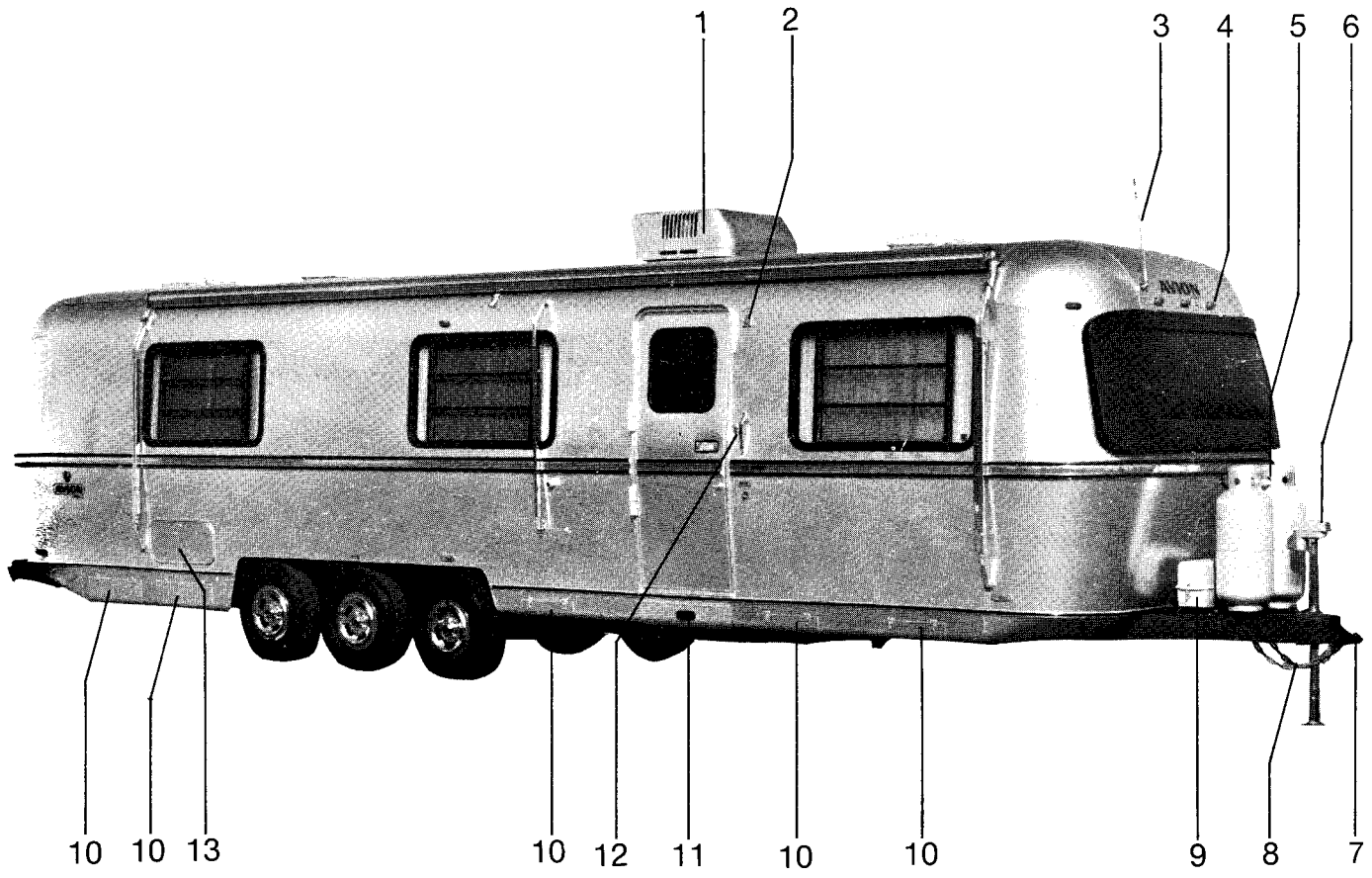

No.	Description	Page No.
1.	Air Conditioner (Optional)	98
2.	Patio Convenience Light	108
3.	Radio Antenna	34
4.	Running Lights	108
5.	LPG Tanks And Regulator	60
6.	Electric Jack (Optional)	32
7.	Hitch	2
8.	Safety Chains	10
9.	Batteries	74
10.	Storage Compartment	—
11.	Folding Step	32
12.	Dead Bolt Lock	—
13.	Trunk Door	—

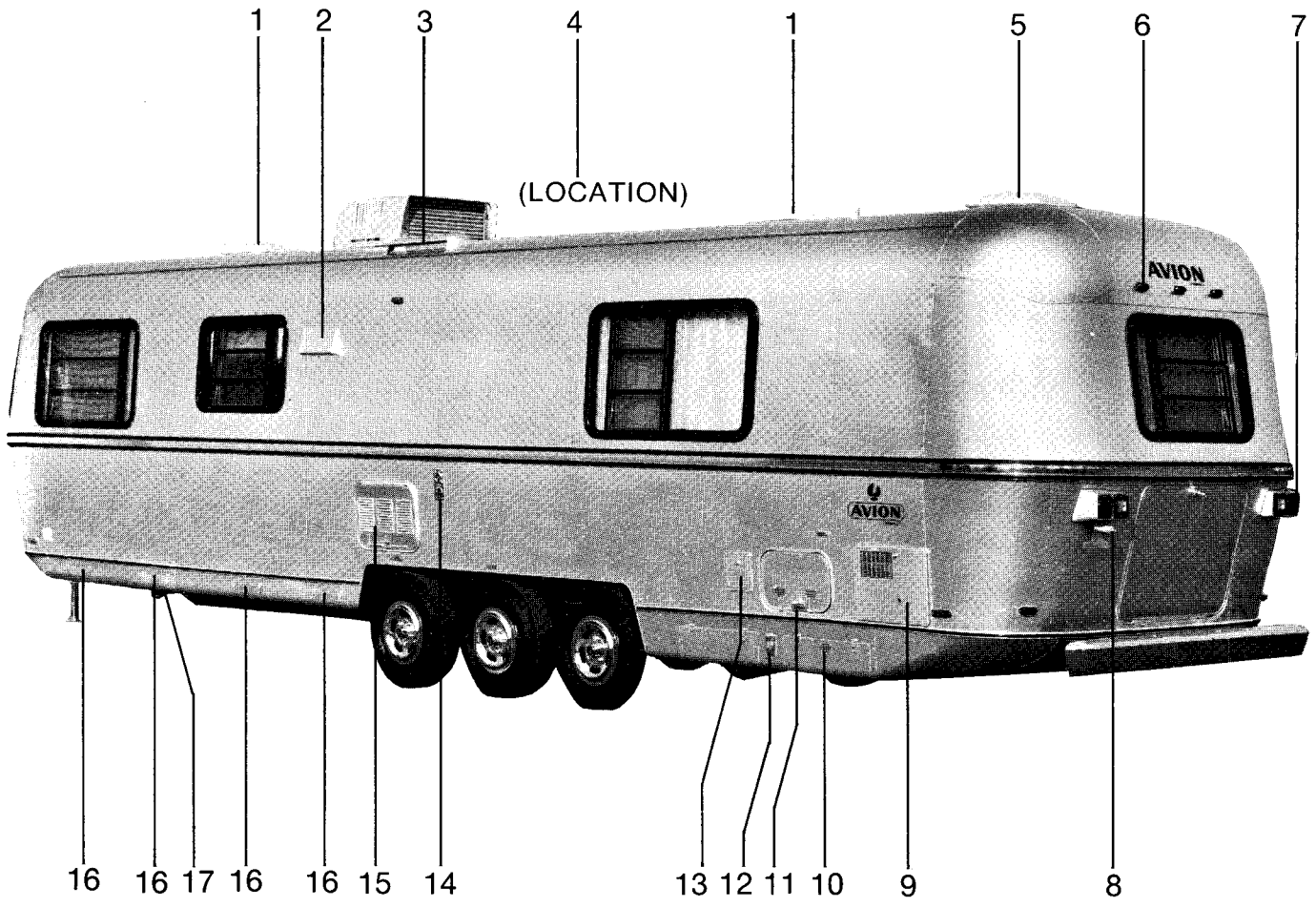

**No. Description**

**Page No.**

1. Roof Vent	48	10. Waste Outlet	68
2. Range And Oven Vent	88	11. Utility Access	21
3. Refrigerator Vent	—	12. Utility Convenience Light	108
4. T.V. Antenna (Optional)	33	13. Water Fill Compartment	62
5. Bathroom Exhaust Fan	51	14. Furnace Vent	92
6. Running Lights	108	15. Refrigerator Access Compartment	82
7. Stop, Tail, Turn And Backing Lights	108	16. Storage Compartment	—
8. Licens Plate Light	108	17. Stabilizing Jacks (Optional)	32
9. Water Heater Access Compartment	95		

---

## Care of Exterior Surfaces

30

The exterior skin of your Avion is fabricated of anodized aluminum for long-lasting beauty and resistance to corrosion or discoloration. You can keep it looking like new by giving it the same care as a fine automobile.

The trailer should be washed periodically with a warm solution of mild detergent or soap. **Avoid strong detergents, solvents or any abrasive cleaners.** The aluminum skin should be cool when you wash it. Pick a shady area or wait for an overcast day, but never wash it in direct sunlight.

Make sure all vents, windows, storage compartments, access panels and the main door are closed tightly, then apply the cleaning solution with a large sponge or soft cloth. Starting with the roof, wash one section at a time and rinse immediately to prevent the cleaning solution from drying on the surface. Road tars, sap, resin and other such materials should be removed as soon as you notice them, before they can harden. Use kerosene, turpentine or naphtha with a soft cloth, taking care not to scratch the surface. Rinse thoroughly with clear water and re wax the affected areas

to protect the finish. **Never use abrasive powders or strong chemicals to remove caked-on foreign matter.**

The aluminum skin should be waxed every three to six months, depending on exposure to the elements. We recommend an aircraft polish, but you may also use any good automotive paste or liquid cleaner wax. Periodic waxing will increase the life of the finish by protecting it from salt air in coastal regions, as well as from air pollution and minor scratches. It will also make subsequent cleaning easier.

The trailer hitch A-frame and back frame can be kept looking as new as the aluminum skin by painting them as needed, using a brush-on or spray lacquer.

Occasionally inspect all exterior seams for holes and cracks, which can sometimes develop from shrinkage of the sealer after prolonged exposure. A good sealant is available from recreational vehicle dealers and automotive supply stores.

---

## Features

### Main Door and Screen Door

The main door is located on the curb side of the coach and opens outward. It can be opened 180° and secured flush against the side of the trailer. Swing door open fully, then push on it until the doorstop pin engages the doorstop receptacle on the outside of the coach. The inside door handle is operated by pivoting it either up or down from its horizontal position. The outside recessed lever is operated by pulling it outward from the door.

A key-actuated lock is built into the main door for maximum safety and security when locking the trailer from the outside. To operate, insert the key and turn it **clockwise**, locking the bolt in the extended position. The bolt must be fully engaged for the door to lock, and once in that position, it cannot be accidentally retracted or vibrate back into its recessed location inside the door.

**Note:** Do not turn the key while door is still open; the extended bolt will then hit the door frame and prevent closure.

To unlock, turn key **counter-clockwise** one-half turn and use handle to open.

The main door lock is operated from inside the coach by a lever at the lower left corner of the door handle panel. Lift upward on the lever to lock the door and push downward to unlock it. Moving the inside handle either up or down will automatically release the lock.

For added security, a dead bolt lock has been installed in the entrance door. It is operated by a key from outside, and by a turn button inside.

Each dead bolt lock is individually keyed. Be sure to keep spare keys outside the trailer for emergency use

Your Avion is also equipped with a screen door, which can be opened and closed independently of the main door or coupled with it to operate as a unit. To link them together, simply push the screen door against the main door. To uncouple, press down on the release latch next to screen door handle. When joined together, access to the main door's inside handle is through a sliding aluminum panel on the screen door.

The main door is closed properly when there is no play in the handle. If you have difficulty locking the door, push or pull it gently to allow full travel of the bolt.

**Important:** Always close and lock the main door with dead bolt before towing. Road vibration may cause an unlocked door to unlatch and swing open while the trailer is in motion, resulting in possible damage.

## Windows and Screens

All windows are made of tinted high-strength safety glass. The louvered vent panes are operated by a knob located at the bottom corner of the window frame. Turn the crank clockwise to open and counterclockwise to close. **The emergency escape window is not louvered and should never be opened except in emergencies or during practice drills.** For operation of this window, see **Interior** section, page 50.

Windows may be washed with the same solution used on the exterior skin, or with any type of household window cleaner. Never clean heavily soiled window glass with a **dry** cloth, which can cause scratches, and do not use strong solvents that can damage the rubber window seals. You can keep these seals flexible and weather-tight with an application of silicone lubricant after the windows have been washed and dried.

The window screens are made of fiberglass for durability and easy care. They can be taken out for cleaning by first removing the vent pane crank handle, then lifting the screen straight up until it clears the lip on the bottom channel. Swing the bottom of the screen outward and pull down to remove.

Lightly soiled screens may be hosed off or cleaned with a damp cloth or sponge. If they have heavy

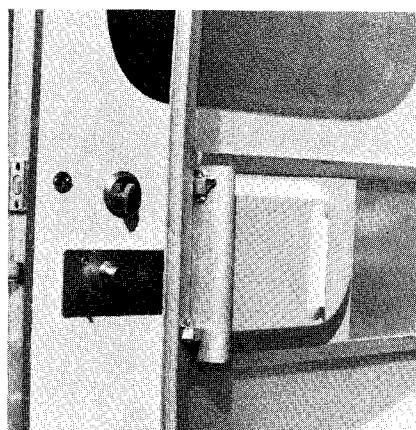

Main Door Handle and Lock

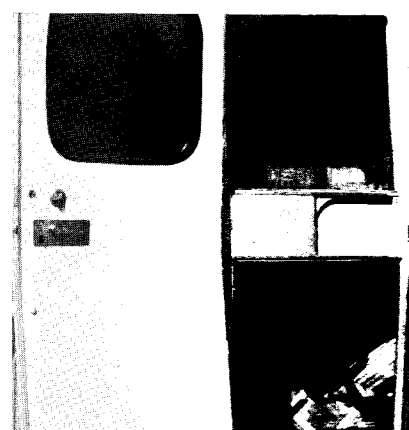

Screen Door

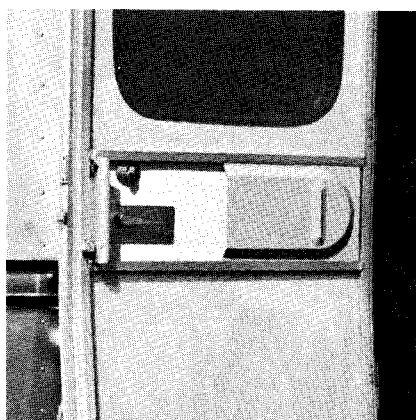

Handle Access, Doors Latched Together

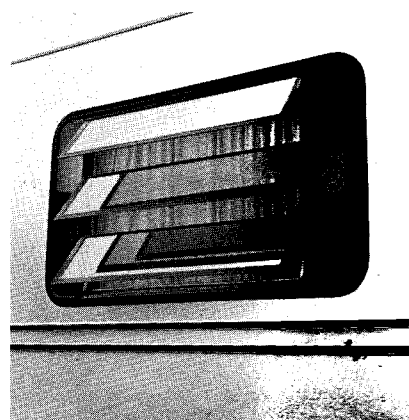

Window Opening

accumulations of dirt or other foreign matter, wash or soak them in a warm solution of detergent and water, then rinse and dry. Do not bear down on the screening material, to avoid stretching it out of shape or possibly warping the aluminum frame. **Never subject it to high heat, such as a lighted cigarette, which will cause the fiberglass to melt at point of contact.**

## Water Leaks

Water can sometimes collect inside the lower portion of window frames, usually as the result of driving in heavy rainstorms. Two or more "weep slots" in the bottom of the frame provide drainage to the outside. Keep them free of dirt, leaves and other obstructions.

If water collects and overflows the bottom channel while driving, even when the weep slots are clean, it is possible that a vacuum has been created inside the coach, drawing water through the window and preventing normal drainage.

In the event water enters around a non-opening window, remove the glazing bead and check condition of the sealing tape. Replace the tape, or caulk with a liquid sealer, if necessary.

It is also possible for leaks to occur at places other than window frames, such as through seams in the exterior skin or around outside light fixtures. You may be able to detect and seal possible areas of leakage by inspecting the seams as recommended earlier in this section, under **Care of Exterior Surfaces**, page 30.

## Folding Step

A folding step is housed directly below the doorway to facilitate entry and exit from the coach. To extend the step, grasp the handle cutout on the hinged cover panel and pull straight out as far as it will go, then let it swing down. Pivot the step out into full horizontal position. Reverse the procedure to store the folding step for travel.

For your safety, the step comes with a non-skid rubber surface. An assist grip is located to the right of the doorway for added convenience in entering and leaving the trailer.

## Storage Compartments

Your Avion features numerous storage compartments conveniently located all around the coach exterior. Some are positioned along the bottom edge of the trailer on the curb and road sides. They are hinged at the bottom and are secured with two latches at the top. A large locking trunk at the rear end of the coach can be used to store a spare tire, various jacks, lug wrench and other gear. The trunk is bottom-hinged and swings down for easy access. Another storage compartment is located directly behind the rear bumper. It may be used to stow the sewer hose and other miscellaneous equipment.

## Power Jack

Raising and lowering the trailer will be easier and faster with the optional power jack, which is operated by a spring return switch with center "off" position. Familiarize yourself with the direction of travel of the jack post and the corresponding switch direction. Raise or lower the coach by removing the switch cover and activating the switch in the appropriate direction. Internal limit switches automatically shut off the motor when the post is either fully extended or retracted. The power jack is protected by a 20 amp fuse located in the battery box on the trailer tongue.

The power jack can also be operated manually in the event of electrical failure. Remove the power head from the jack post by loosening the two allen set screws with the wrench provided, then insert the emergency handle into the coupling on top of the jack post.

**Important:** It is essential to carry out the following procedure **before** replacing power head on the jack post. Ground the power head to the trailer A-frame with 12 volts connected, then operate the switch in **post retracting** direction until the motor stops automatically. Using the emergency handle, crank jack post **clockwise** until fully retracted, then rotate handle one turn **counterclockwise**. Replace power head on post, making sure drive pin is engaged with the post coupler, then tighten allen set screws.

Minimum regular maintenance will keep the power jack operating up to design specifications.

1. **Once each year:** Remove the power head and apply a high-melting-point grease to the post coupler. **Do not** pour oil on top of the post. When replacing the power head, always carry out the synchronizing procedure outlined above.
2. **Once every two years:** Remove the housing cover and inspect gears for proper lubrication. Spread a high-melting-point grease on gear teeth. Grease is not required on the nylon timing gears. Before replacing cover, be certain the plate and limit switch unit are located correctly. Apply a small amount of sealing compound around the mating

surface of the cover before engaging the screws. Check synchronization if power head has been removed from jack post for maintenance.

## Stabilizing Jacks

Stabilizing jacks are permanently installed on the frame under the coach and are deployed only after the trailer has been leveled side-to-side and front-to-rear. To operate, position the end of the crank handle over the stabilizer nut and turn until the jack is resting firmly on the ground. Start with the low or "downhill" side, then repeat the procedure on the opposite side, putting slightly less pressure on the "uphill" side jacks after they have made contact with the ground. To raise the stabilizing jacks for travel, crank them up as far as they will go, to assure maximum ground clearance.

**Caution:** Never use stabilizing jacks to level or raise the trailer or to change a tire.

## Sway Control Device

Some types of trailer sway can be moderated by taking preventive measures, such as maintaining proper tire pressure and sound suspension systems, and distributing weight loads in accordance with design specifications.

The primary causes of sway, however, are strong wind gusts and the compression and displacement of air by large passing vehicles. These effects can be reduced by the installation of a friction-type sway control device. It attaches easily to most weight-distributing trailer hitches and can be activated or disengaged at will. Sway controls are available from most recreational vehicle supply stores and trailer hitch installers.

**Important:** Anti-sway hitches are required by law in some states. Make certain you comply where applicable.



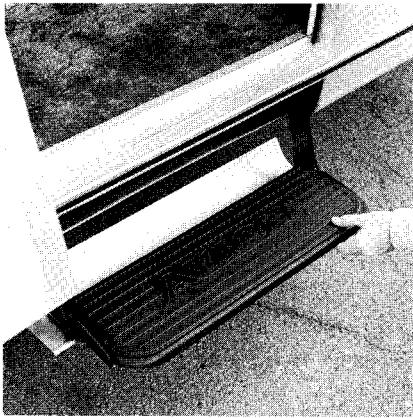

*Folding Step Extended*



*Main Door Assist Grip*

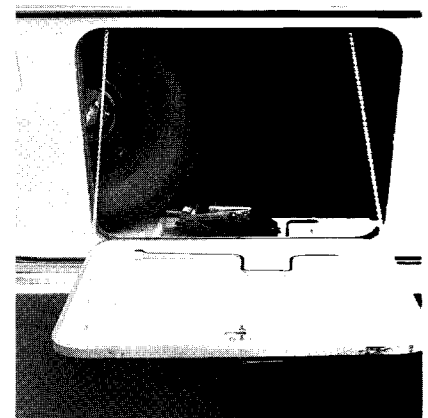

*Rear Trunk, Spare Tire Storage*

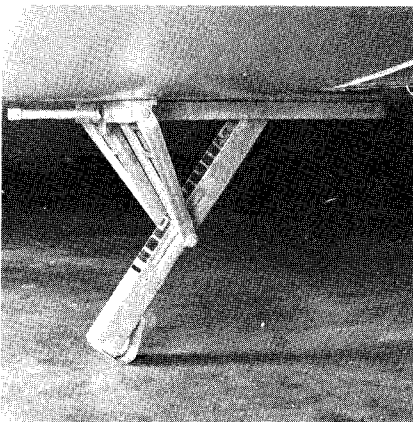

*Attached Stabilizing Jacks*

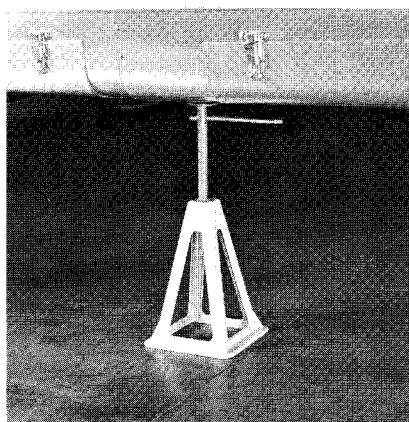

*Freestanding Stabilizing Jacks*

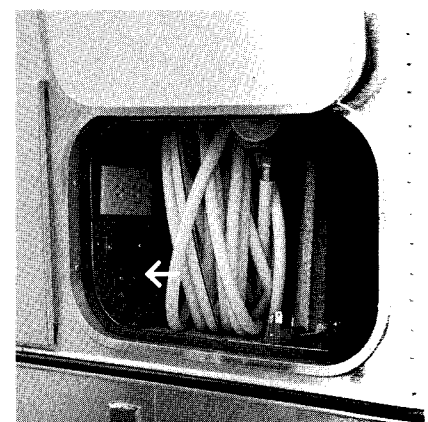

*Cable TV Terminals*

### **Television Reception System**

Your Avion has been pre-wired to receive television signals over-the-air and by cable. Two hookups are located conveniently inside the coach. They feature a combination TV antenna jack/12-volt electrical outlet, and a separate cable TV jack. Your trailer is also equipped with the roof-mounted, all channel Braund television antenna, made by the Braund Manufacturing Company. The main hookup location will include an amplifier switch and "power on" red light.

While staying at trailer parks or other facilities that offer cable television, you can take advantage of this service by hooking up to their coaxial line. A two-connection Cable TV terminal block is located in the 110-volt power cord compartment outside the trailer. Use a coaxial adaptor to connect the cable to the terminal screws, then unplug TV set lead-in wire from the TV antenna jack and plug into the adjacent Cable TV jack.

### **TV Antenna Operation**

Before extending the antenna, check for overhead obstructions such as tree limbs. Raise the antenna by pulling the ceiling crank downward and rotating the knob counterclockwise until the "stop" is reached, then back off the crank handle approximately one-half revolution. Push the crank body upward and with a slight clockwise turn, to engage the rotation pin. The antenna can now be rotated in either direction with the crank body for best reception.

**Important:** The antenna is prevented from rotating 360° in either direction by "stops." Do not attempt to rotate it beyond these points. Instead, turn in **opposite** direction.

Whenever practical, you should select a parking place that allows line-of-sight reception from the television transmitter. If you are located in a canyon or mountainous terrain, TV picture quality will be adversely affected. Poor pictures or sound can be caused by other factors, as well. Check all wiring for loose or dirty connections and possible short circuits. Also make sure the TV antenna's power amplifier switch is turned on.

34

When you are ready to lower the antenna for traveling, first rotate it clockwise to a "stop" position, thus placing it in line to be retracted into the travel support. Pull down the crank handle to disengage the rotation pin and then turn the crank handle knob **clockwise** until it reaches the lower "stop." The sound of the antenna making contact with the travel support will be audible when this happens.

**Important:** Force is not required to operate the antenna. If it does not extend, rotate and retract easily, check the installation manual.

The antenna has been fully lubricated, but it is recommended that you use a silicone spray occasionally and add a good grade of grease to the gears once a year, if needed. Consult your Braund antenna installation manual for detailed instructions.

**Important:** Never travel with the television antenna in the raised position. Any contact with overhead obstructions can damage the gears and the antenna itself.

### **Radio Antenna**

Standard equipment includes an AM/FM radio antenna mounted outside the coach at the front end. While the AM band is relatively unaffected by terrain, for optimum FM reception you should look for the same kind of line-of-sight location as television requires.

**Note:** The metal construction of your Avion acts as a shield against all radio and television signals. For satisfactory reception, therefore, you must always use an outside antenna or plug into a cable television source, where available.

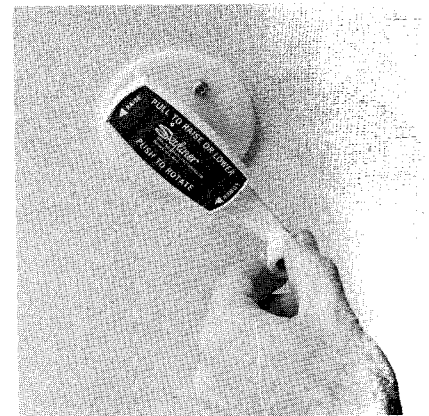

TV Antenna Controls

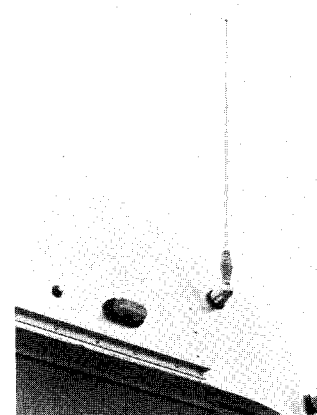

Radio Antenna

# Tires and Wheels

Your Avion is equipped with name-brand tires built to give thousands of miles of worry-free driving at sustained highway speeds. They are covered by the tire manufacturer's standard warranty. Any adjustment must be made by an authorized tire dealer who handles that particular brand.

## Tire Care

Tires that run either under-inflated or over-inflated will not perform as intended and will suffer erratic and premature tread wear. Consequently, you should check air pressure frequently with an accurate gauge. Inexpensive gauges that will give precise readings every time are readily available. **Never rely on pressure indicators that are built into service station air hoses.**

Always check air pressure when the tires are **cold**; that is, after the trailer has been stopped for three or more hours, or has been driven less than one mile from a cold start. Never bleed air from a hot tire (one that has been driven 10 or more miles at speeds in excess of 50 mph). It is normal for tire pressure to increase as much as six pounds per square inch (psi) when hot. Recommended tire pressure can vary according to model, type and size of tire and by the weight load being supported. **Inflate as close to the maximum recommended tire pressure as possible for best tread life and trailer stability. Maximum tire load and cold inflation pressure information may be found on the tire sidewall.**

Tire life can also be affected by frequency of rotation and adjustment of toe-in. Regular inspection and maintenance of these items can add many miles of tread life. See **Suspension**, page 41.

Tread is not the only part of a tire that can wear out prematurely. Sidewalls can weaken and crack from improper inflation, weight loads beyond design specifications, or the effects of air pollution and ultraviolet radiation. Park in shaded areas whenever possible and use tire covers in desert regions to block harmful rays from the sun.

If the trailer is to be out of service for any extended period, including winter storage, block up the axles to remove weight from the tires and to keep them from developing flat spots. Also reduce the air pressure to 10 psi in each tire.

**Important:** Inflate all tires to normal pressure before removing the blocks.

One additional tire care tip: Every time you check air pressure, also check tire valve stems for cracks and tighten the valve cores. Air leaks from these sources can flatten a tire as quickly as a puncture.

## Wheels

All wheels are balanced at the factory. If the tire is removed from the wheel (such as to repair a flat), place reference marks on the sidewall and rim, so that the tire can be lined up again to retain balance. See following section on **Tire Changing** for more information.

Wheel bearings should be repacked with grease and adjusted every 10,000 miles. Lug bolts should be torqued to 90-95 foot-pounds. Recheck them after the first 100 miles and before starting each trip.

Examine all suspension mounting bolts periodically to be certain they have not backed off and are snug. The axle bushing bolt should be torqued to 120-150 foot-pounds. Tighten spring hanger bolts and rocker arm link bolts until snug and then back off one half to three quarters turn. All suspension mounting bolts are self-locking.

## Tire Changing

Changing a tire on your Avion is no more difficult than changing one on your automobile, but there are some notable differences.

1. Place a jack **under the axle** of the tire you are removing. Then chock all other wheels and raise the jack until the tire barely touches the ground. This will take most of the weight off the wheel but will give you enough leverage to break the lug bolts free without the tire spinning.
2. Break the lug bolts free with lug wrench, but do not loosen.
3. Raise jack until tire is completely off the ground, unscrew all lug bolts, and remove wheel.
4. To reinstall the tire, first make sure that drum and hub are free of dirt, then lift wheel into place and line up lug bolt holes.

5. Start all lug bolts and then tighten by hand.
6. Lower the jack until tire barely contacts the ground, then finish tightening the bolts with lug wrench, using a criss-cross pattern. Bolts should be tightened to a torque of 90-95 foot-pounds.
7. Lower the jack completely and remove it. Also remove wheel chocks.
8. Recheck tightness of lug bolts after 100 miles and before each trip.
9. Handle wheels with care to avoid damaging their appearance.

## Tire Rotation

Trailer tires should be rotated every 5000 miles to promote even tread wear and long life. Rotate them sooner if irregular wear develops. The rotation pattern varies, depending on whether radial-ply tires or bias-ply tires are being used.

1. **Radial-Ply Tires.** Move front tires to the rear and rear tires to the front on the **same side** of the coach for dual axle trailers. For triple axle trailers move front tires to center position, center tires to rear and rear tires to the front on the **same side** of the coach.
2. **Bias-Ply Tires.** For double axle trailers move front tires to the rear on the **same side** of the coach. The rear tires **cross over** to the front; that is, left rear tire moves to right front and right rear tire moves to left front. For triple axle trailers move front tires to center positions, center tires to the rear on the **same side** of the coach. The rear tires cross over to the front.

The identical pattern should be used every time you rotate the tires, otherwise you will be nullifying the intended benefits.

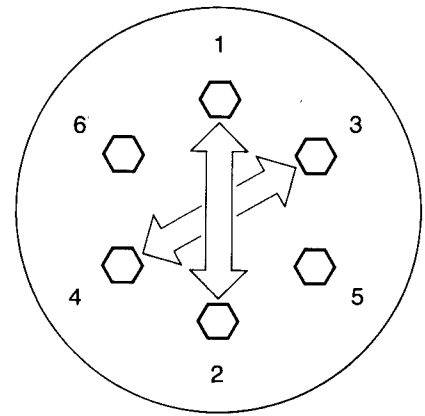

Lug Bolt Tightening Sequence

**Note:** The riding characteristics of radial and bias-ply tires differ. We recommend that you do not mix the two types on the trailer.

## Wheel Balancing

The wheels on your Avion were balanced at the factory for a precision ride. Therefore, whenever a new tire is installed on a wheel, it must be balanced. Do this as soon as possible for smoothest, safest ride. Refer to **Tire Changing**, earlier in this section, for more details.

Radial-Ply Tires

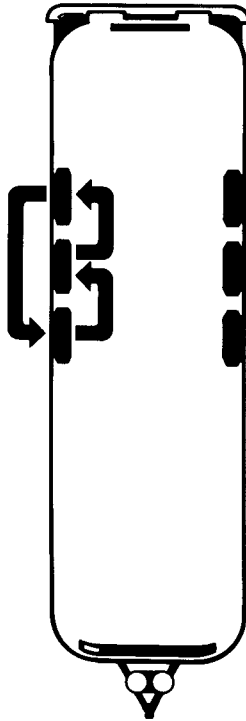

Bias-Ply Tires

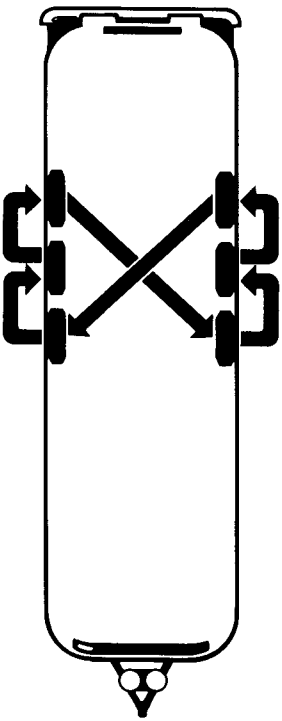

---

# Braking System

The Kelsey-Hayes Company electric brakes on your trailer are operated by 12-volt direct current from the tow vehicle. The brakes have been factory-calibrated for smooth, positive response. Routine periodic adjustments should be performed only by an Avion dealer service technician or other qualified mechanic.

## **Components of the Braking System**

The wiring system connecting trailer brakes with the tow car's electrical power begins and ends at the car battery and includes several major components, all of which must function properly for safety and responsive braking.

1. **Car Battery.** The connection is made at the starter solenoid's battery terminal or the positive post of the battery itself.
2. **Brake Controller.** The electric trailer brakes are automatically applied by the brake controller, which is mounted within easy reach of the tow car driver. When the car's brake pedal is depressed, the trailer brakes are actuated slightly before the tow car brakes, to keep the two vehicles in alignment. The lag time can be adjusted by turning the brake controller knob in accordance with instructions provided with the controller. **The new setting will be retained until a further adjustment is made.** The brake controller also has a manual

feature, which allows you to apply the trailer brakes independently of the tow car brakes. To operate, move the control lever all the way to "manual" and hold it in that position. The lever is spring-loaded and will return to the "automatic" setting when released.

Select a brake controller that will be compatible with your Avion's electric braking system, such as Kelsey-Hayes or equivalent.

**Caution: Do not install a fuse in the circuit between tow car battery and brake controller. A blown fuse would cause the controller to cease functioning both automatically and manually, causing loss of trailer braking power with no advance warning.**

3. **Connector Plug.** The 7-way connector on the trailer hitch transfers electrical power from the tow vehicle battery to the trailer brakes and exterior lighting system. Keep the plug clean, tight, and protected from the elements.

4. **Break-Away Switch.** This fail-safe device is one of the most vital components in your Avion's braking system. It automatically actuates the trailer brakes instantly in the event tow car and coach accidentally uncouple while in motion. The break-away switch goes into operation when a pull pin linked by cable to the tow car is separated from the switch. This allows two contacts in the switch to close and complete an electrical circuit, which instantaneously applies the trailer's brakes and brings it to a stop. Power for this sequence is automatically switched to the on-board trailer batteries from the tow car battery, which stops furnishing power when the 7-way connector disengages during vehicle separation.

The steel cable attached to the break-away switch pull pin must be anchored to the tow car at time of hookup. We recommend securing this cable loop to the permanent frame of the tow car hitch, not the removable section of the hitch.

The pull pin should be removed and lubricated with light household oil every three months, to assure that it will operate as intended. Before reinserting the pin, spray the inside of the break-away switch with an electrical contact cleaner to prevent corrosion.

**Caution: Do not leave pull pin out of the break-away switch for more than a few minutes, or it will run down the trailer batteries. For the same reason, never use the break-away switch as a parking brake.**

5. **Trailer Brakes.** Your Avion's brakes are actuated by electrical energy, which is converted to mechanical energy to provide the braking power for smooth, safe stops. The greater the braking effort from the brake controller, the greater the braking force applied to trailer brake drums. You can monitor the application of this braking force either by using a brake controller with built-in indicator light, or by installing a separate indicator light on the tow vehicle dashboard. The light will glow whenever trailer brakes are activated, and will become increasingly brighter as braking power is intensified.

6. **Grounding.** The electrical circuit that operates your trailer brakes can be completed only by proper grounding back to the tow car battery. **A poor ground circuit from brakes to battery can be as detrimental to efficient braking as a poor primary circuit from battery to brakes.**

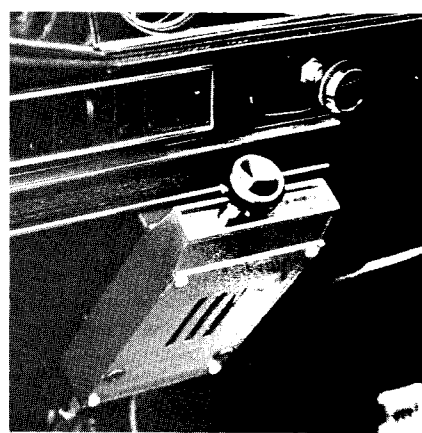

*Brake Controller*

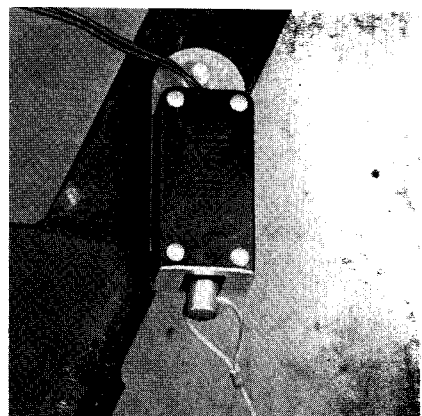

*Break-Away Switch*

## Adjusting the Brakes

While it is recommended that brake adjustments be handled by qualified technicians, the following procedure should be used if you find it necessary to perform the job yourself.

1. Remove rubber plug from the adjustment hole at base of brake drum backing plate.
2. Raise wheel off ground with a lifting jack placed under the axle (see **Tire Changing**, earlier in this section).
3. Tighten brakes by inserting a brake adjustment tool or screw-driver blade into the backing plate hole. Turn adjustment screw while spinning the wheel. When wheel begins to drag heavily, back off just enough for it to spin freely. Replace adjustment hole plug, then lower and remove the jack and repeat the previous steps with all other trailer wheels.

## Braking Tips

1. **Never use trailer brakes alone for extended periods.** They were designed to stop the coach, not the tow car. Such action would place excessive loads on the brakes, causing overheating, loss of braking power (fading), and premature wear of shoe linings and drums.
2. **Never use the tow car brakes alone.** The added weight of your trailer more than doubles the load placed on car brakes, leading to the same results as using trailer brakes alone: Overheating, brake fade and rapid wear. Driving control is also hampered when tow vehicle brakes are used alone, due to the force of the trailer pushing against the car hitch. This is especially true on slick pavement or loose gravel, and can cause jackknifing.
3. **Always use the automatic brake controller.** This synchronized braking system enables you to drive in the manner recommended by the experts: Both hands on the steering wheel. The brake controller is properly adjusted when there is a slight "lead" on the trailer brakes. This braking resistance, combined with the tow car's engine pulling power, will keep the two vehicles correctly aligned and bring them to a safe, straight stop every time.

## Brake Adjustment

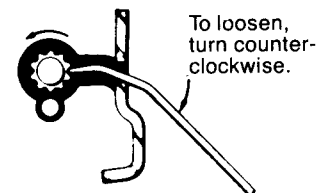
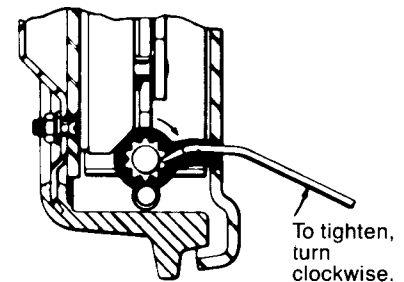
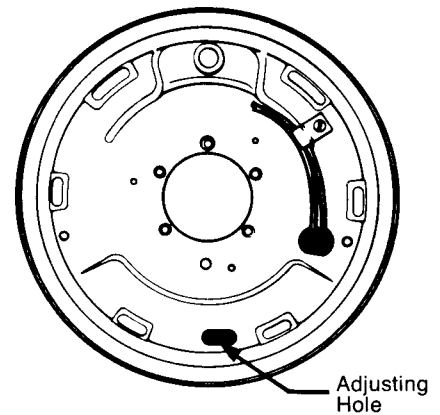



---

# **Suspension System**

Avion's exclusive Adjust-A-Ride™ All-Wheel Independent Suspension represents a significant advancement in trailer suspension systems, combining European-type independent suspension at each wheel with adjustable split axles, to meet a variety of traveling conditions. Adjust-A-Ride™ was subjected to thorough testing by an independent testing agency before being introduced as standard equipment on all Avions.

Adjust-A-Ride's split axles absorb road shocks and vibrations right at the wheel, instead of transmitting them to the opposite wheel and then through the entire coach frame and body, as happens with standard one-piece axles. Heavy duty springs and single shocks at each wheel work in unison with the split axles to further cushion the smooth ride.

The result: Adjust-A-Ride™ keeps your new Avion tracking straight and true even over irregular surfaces, with less "whipping" action. The split-axle configuration also reduces trailer lean on turns, resulting in improved handling characteristics. This provides a stable, controlled, glass-smooth ride that makes your Avion what we believe to be the easiest-towing travel trailer ever built.

The unique Adjust-A-Ride™ system also permits toe-in/toe-out adjustment, a feature not found on solid axle coaches.

## Toe-In Adjustment

Toe-in simply means that the wheels on a given axle are closer together at the front end than at the back. For **accurate tracking, maximum tread life and greatest fuel economy, your Avion should have a toe-in of zero to plus or minus 1/16-inch on each wheel.** Avion's Adjust-A-Ride™ allows you to make wheel alignment corrections yourself with minimal equipment. You will need a scissor jack and a 15/16-inch socket wrench or large adjustable-end wrench.

1. Pull the normally-loaded coach forward with a tow vehicle a minimum of 25 feet on a reasonably level surface. Let it roll to a stop without applying the brakes. This will allow the wheels to assume a normal towing position.
2. Starting with any wheel, mark a point on the tread at the front of the tire. Measure the distance between that point and the chassis rail. Locate a corresponding point on the tread at the rear of the same tire, and measure the distance between it and the chassis rail. (See Figure A. Repeat this step for each wheel.

If the difference between the front and rear measurements of a wheel is 1/8-inch or less, the wheel is properly aligned; if it is greater than 1/8-inch, a correction should be made.

3. Place a scissor jack under the inboard end of the axle, and raise it just enough to be snug. This takes the weight off of the bolt on which the axle is hinged. (See Figure B.) Note that several spacer washers are positioned on both sides of the axle bushing. The wheel is aligned by moving one or more washers from one side of the axle bushing to the other. (See Figure C.) The number of washers to be switched is determined by the difference

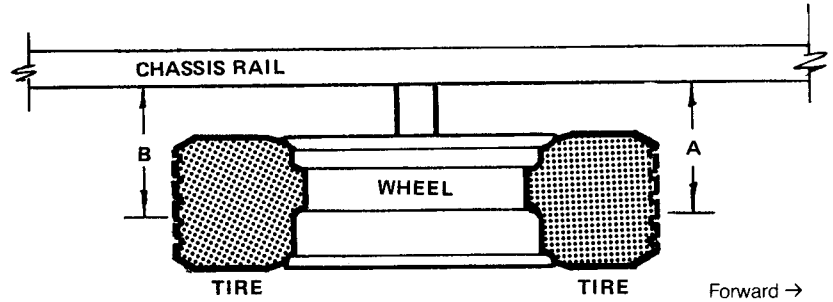

Figure A

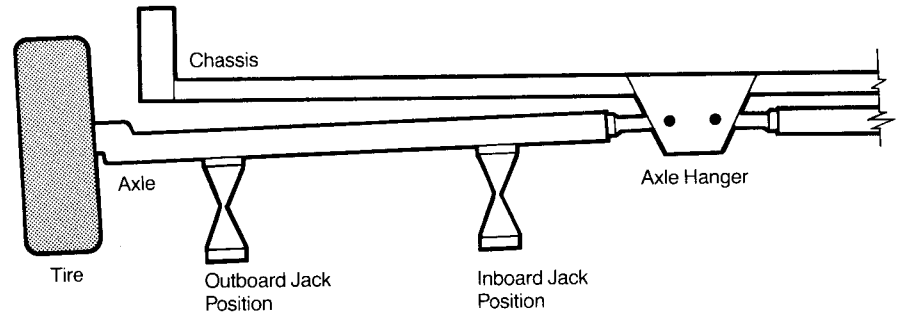
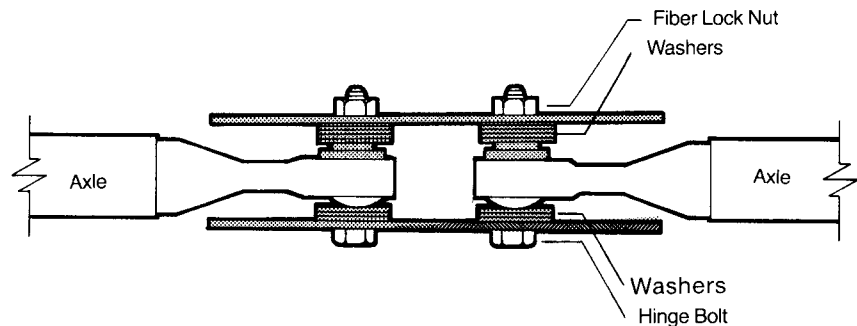

Figure B



between measurements taken in step 2. (See Figure A.) One washer is moved for each  $\frac{1}{8}$ -inch difference. For example, if the measurements were  $7\frac{5}{8}$  inches at the front of the tire and  $7\frac{7}{8}$  inches at the rear, the difference of  $\frac{1}{4}$ -inch would represent two washers. The wheel is toed-out if the front measurement is greater, and is toed-in if the rear measurement is greater. (See Figure D.)

4. After determining how many washers are to be moved and where, count the number on each side of the axle.
5. Remove fiber lock nut and tap out the hinge bolt with a hammer and punch. If the bolt does not dislodge with a little effort, raise or lower the jack until bolt is freed.
6. Relocate washers as indicated in step 3. A large screwdriver may be required for leverage when installing the last one. (See Figure E.)
7. Replace the hinge bolt and fiber lock nut. Torque to 125 foot-pounds.
8. Lower the axle, remove scissor jack and check toe-in adjustment by repeating steps 1 and 2.

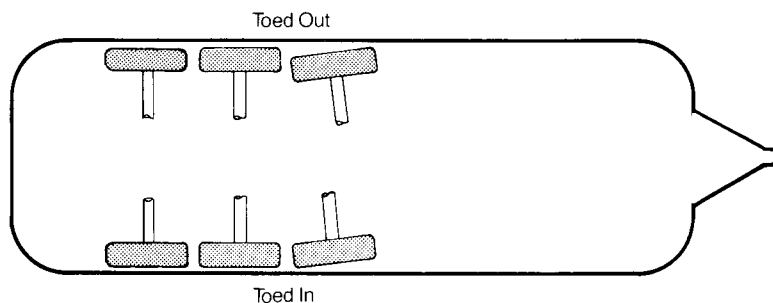

Figure D

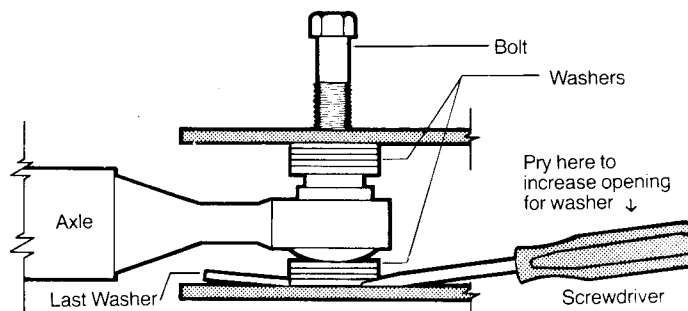

Figure E

# Interior

---

Furniture and Features 46

---

Care of Interior Surfaces 52

---

Monitor Panel 54

---

Floor Plan 57

---

# Furniture and Features

The interior of your Avion has been crafted without compromise for comfort and convenience, using materials selected for long life and ease of maintenance. While a large number of features have been included in a relatively small amount of space, extensive planning assures that everything you need is at your fingertips, yet not in the way.

The best way to fully enjoy and appreciate all of the engineering and design systems built into your coach is to thoroughly understand them. The following material provides detailed information on the location, operation and care of all of Avion's amenities.

## Beds

The beds in your travel trailer feature Sealy® Posturpedic mattresses, considered to be among the finest on the market for comfort, support and durability. Turn them periodically for maximum benefit.

1. **Sofa-Bed Into Double Bed.** To convert sofa-bed for sleeping, grasp the front rail of the seat at the middle, lift it up slightly, and pull it out as far as it will go. Then lower the back cushion until it falls into place.

Revert to sofa arrangement by pulling the back cushion upright and pushing the front rail back to its original position.

2. **Sofa Into Bed.** To convert sofa into bed, simply remove back cushions.

3. **Lounge Into Double Bed.** To convert lounge into bed, remove boards stored under lounge seats, lay them across front edges of the facing lounge frames, and place seat back cushions in position on top of the boards. Reverse the process to set up lounge again.
4. **Dinette Into Double Bed.** To convert the dinette into a bed, stand the seat cushions on edge to allow room for table to swing down, then fold up the table leg and lift table free of its wall brackets. Swing the table downward to its lower position and rest it on the supports provided. Replace cushions to form the bed.

Convert back to dinette by first positioning the cushions so they will not interfere with movement of the table. Pivot table upward and engage the wall brackets, then extend the folded leg to vertical.

5. **Making Up Fixed Beds (Twin or Double).** If your Avion is equipped with fixed beds, they can be easily prepared for sleeping by lifting the mattress slightly, pulling it away from the wall, and tucking in the bedding.



*Sofa Bed Into Double Bed - Step 1.*



*Step 2.*

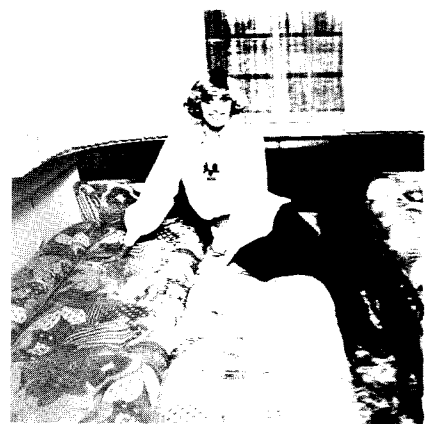

*Step 3.*



*Sofa Into Bed*

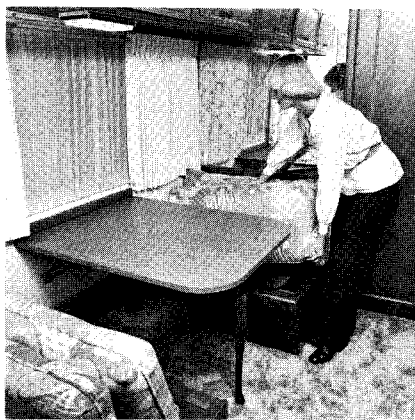

*Dinette Into Double Bed - Step 1*



*Step 2.*



*Step 3.*



*Step 4.*

---

## Extension Table

1. **Open the table** by swinging the table top up from the wall and into a horizontal position. Swing the leg down until it locks in a vertical position.
2. **Extend the table** by first releasing the latch located underneath, next to the leg. Lift table and leg slightly, and pull the telescoping frame all the way out. Insert individual leaves into the frame for desired table length, then push in the end leaf to close any gaps.
3. **Stow the table** by first removing the leaves, then lift table slightly off floor and push the frame back into its telescoped position under the table top. Fold the leg into stowed position, then swing table top down until it rests against the wall for traveling.

## Curtitions

Accordian-type curtitions allow you to change the interior configuration of the coach. They provide an open, spacious atmosphere when fully retracted, and

serve as a room divider when partially extended. They can also be fully opened and latched together for complete privacy, closing off the lounge/sleeping area from the rest of the trailer.

## Drawers and Storage Cabinets

All drawers are quality constructed of rugged poplar and feature dovetail joints for maximum strength and durability. They have been designed to remain tightly closed while traveling, and are opened by lifting slightly on the drawer knob and pulling out.

The overhead storage cabinets are hinged at the top and have two spring-loaded struts. Once opened, they will stay in that position until you close them. And once closed, they will remain that way to keep contents from spilling out during travel. Additional storage cabinets are provided under all beds and lounges.

There is even a swing-down utensil bin behind the front panel of the galley sink and a slide-out towel rack behind a door next to the gas range. They control clutter by keeping things out of sight yet handy.

## Roof Vents

The roof vents have been designed to function in any weather, letting in fresh air while keeping out precipitation. Air flow is controlled by two crank handles located at opposite ends of the vents. Each crank raises one end of the vent cover and can always be operated independently. If the vents are left open while traveling, only the **rear** portion should be raised.

To open a vent fully, rotate both crank handles counterclockwise; to close, rotate them clockwise. An electric fan inside each vent can furnish additional air circulation when the vent is open. A three-position fan switch (low-off-high) is located on the side of each roof vent screen.

Vent screens may be cleaned periodically to maintain maximum air flow and fan efficiency.

1. Remove the two crank handles with a Phillips head screwdriver.
2. Remove the six clutch-head screws holding the screen frame in place.
3. Wash screens in soapy water, taking care not to push the screening material out of shape. Allow screens to soak if there is any caked-on material. Rinse and wipe dry.
4. Reinstall screens with the clutch-head screws and attach crank handles.



*Fold-Up Table Opening—Step 1.*

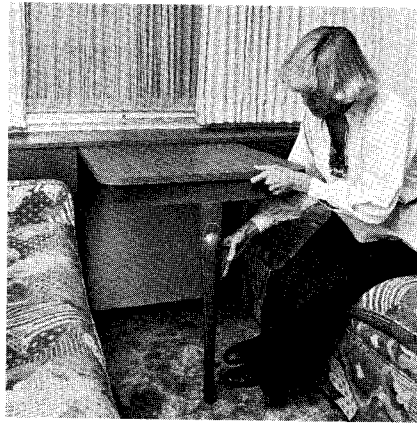

*Step 2.*



*Step 3.*



*Curtitons*



*Towel Racks*

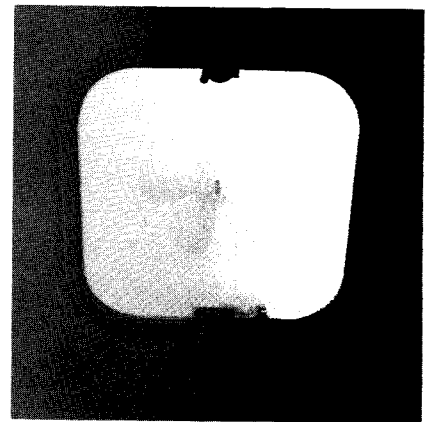

*Roof Vent*



## Emergency Window

The emergency escape window provides the safest and fastest exit when the main door is obstructed; it should be used only when absolutely necessary.

The emergency window's escape mechanism is operated by two quick-release latches that fit over projections at the bottom of the window frame. **To open, grasp the latches and lift until they clear the retainers.** The window is hinged at the top and will swing outward when pushed at the bottom.

**Caution: The emergency window has been designed to separate from the top hinge and drop out of the way when opened beyond a certain angle. You can familiarize yourself with this feature by opening the latches and holding the window on both sides while pushing out slowly until it releases from the top hinge.**

We recommend that you practice the escape procedure until it becomes automatic, and that you review it periodically. **When practicing, do not permit the window to swing out far enough to disengage from the hinge.** If it does, be prepared to catch it.

## Light Fixtures

The interior lighting system has been carefully planned to satisfy a variety of requirements throughout the coach. It gives you proper, convenient illumination when you need it and where you need it. See page 108 for bulb specifications.

1. **12-Volt fixture lights** are controlled by an on-off switch located on the individual fixture. For access to the bulb compartment, squeeze the flexible diffuser lens until it drops down (see photo). Reinstall by squeezing the lens and inserting it into the fixture frame.

2. **The range hood light** is operated by an on-off push button located on the hood frame between the light and exhaust fan. To replace the bulb, remove the retainer nuts from the hood light and exhaust fan on-off buttons and let the frame drop down, allowing access to the bulb compartment.

3. **Area lights and reading lights** are controlled by an on-off switch on the rim of the fixture itself. They have no lens diffuser and can be swiveled to concentrate light where desired. To remove the bayonet-type bulb, simply push up, give a ¼ turn and let it drop out. To install a new bulb, line up the bayonet studs with the slots inside the socket, then push up and give it a ¼ turn until it locks in place.

**Caution: The lamp cones on these fixtures become too hot to touch. Use a protective cloth when adjusting their position.**

4. **Rear bathroom mirror lights** house three bulbs and offer two lighting combinations: One bulb on, or all three bulbs on plus OFF. They are operated by a switch at the bottom of the fixture. To remove the diffuser lens for bulb replacement, squeeze the sides of the lens until it releases.

## Shower/Tub Enclosure

The enclosure is molded of special fiberglass-reinforced polyester... a high-strength, long-wearing material specifically designed to retain its beauty for many years with proper care. Clean the shower/tub with soap or detergent, or a special tub and tile product. **Never use abrasive scouring powders.** We suggest applying a coat of paste wax before using the shower/tub for the first time, and again after each heavy cleaning. This will protect the surface from stains and discoloration.

The vinyl shower curtain should be sprayed with clear water from the hand-held shower head after each use, to remove soap spots. To launder the shower curtain, hand wash or machine wash on delicate cycle using medium temperature and a mild soap. **Do not use bleach.** Remove from machine before final

spin cycle and allow to drip dry. **Do not iron vinyl curtains.** If your shower curtain has a fringe attachment, it should be hand washed only.

The shower/tub enclosure also features a removable clothes rod in addition to the regular shower curtain rod.

## Shower Head and Bathtub Spout

A single mixer knob is used to control water flow and to adjust temperature. Push knob back to turn on water, pull forward to turn it off, and rotate to adjust temperature setting.

The shower/tub faucet also features a push button directly below the control knob to divert water from the bathtub spout to the shower head. To operate the shower head, turn on faucet. Water will flow through the bathtub spout until the diverter button is depressed. Hold button in until water flows through shower head. To restore water flow to the bathtub spout, simply pull out the diverter button. In addition, the diverter button will **automatically** reset to feed water to the bathtub spout when the faucet is turned off.

The telephone-style shower head can be used interchangeably as a hand-held unit or mounted on an adjustable wall bracket. When hand-held, it conserves water by allowing you to direct the spray over the entire body. First wet down, **then turn off the water by depressing the button directly under the spray nozzle.** Apply soap and lather thoroughly, **then press the button in the opposite direction to restore flow,** and rinse. The shower head can be turned off and on in this manner without affecting water temperature setting. Because it is a volume control rather than a shut-off valve, it

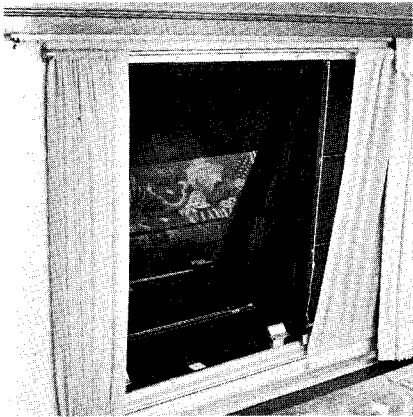

*Emergency Escape Window*

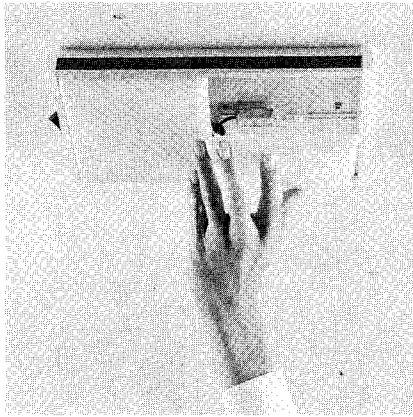

*12-Volt Fixture Bulb Replacement*



*Area Light*

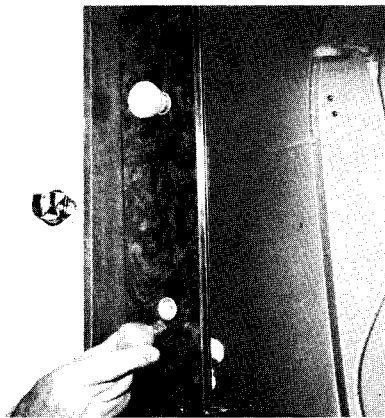

*Bathroom Mirror Light Bulb Replacement*

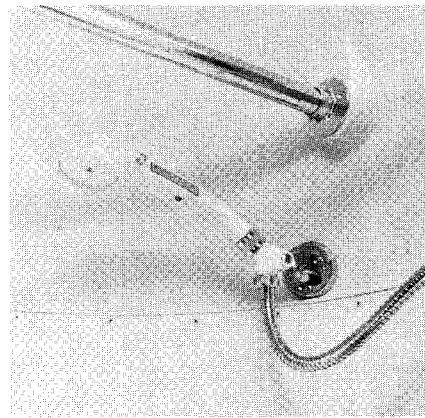

*Telephone Shower Head and Clothes Rod*

is normal for water to trickle from the spray nozzle while the shower head button is in the "off" position.

The **diverter button** should not be confused with the **shower head button**. The former diverts water flow from bathtub spout **through shower hose to shower head**. The latter simply cuts off the diverted water **at the shower head**.

### ***Bathroom Sink***

The sink is constructed of porcelain-clad steel and can be cleaned with any non-abrasive household product. The faucet is a single-control type: Push the knob back to turn on water and pull forward to turn off water. Rotate left or right to adjust temperature.

### ***Exhaust Fan***

The bathroom exhaust fan keeps the air fresh and clean, and also removes excess heat and humidity resulting from hot water usage.

---

# Care of Interior Surfaces

## Galley Sink

The sink is outfitted with a single-control faucet and spout. Push back on the lever to turn on water, and pull forward to turn it off. Water temperature is selected by moving the lever sideways: Left for hot, right for cold.

The stainless steel double sink will retain its original luster indefinitely with proper care. Boiling water will not harm the surface, but condiments such as salt, mustard, mayonnaise and ketchup can pit stainless steel if not cleaned up immediately. Ordinary soaps and detergents are recommended for routine cleaning and to prevent build-up of soap scale. Always rinse thoroughly and wipe dry with a soft cloth to prevent streaking or spotting.

Heavy food stains can be removed with a paste made of water and **slightly** abrasive cleaning powder. Always rub in the direction of the original polish marks or "grain" to avoid the formation of noticeable scratches.

An application of cleaner that leaves a thin wax coating is effective in controlling oily fingerprints. They can be removed by wiping with a soft dry cloth. The stainless steel surface should be washed and dried thoroughly before waxing.

## Counter Areas

All counter tops and splashboards are made of high pressure laminates and can be cleaned with a mild

detergent or water, or with an all-purpose household cleaner. **Do not use abrasive powders, which can scratch and dull the finish.** Always use a trivet or protective pad when placing hot utensils on counter tops.

Additional counter space is provided by two laminated boards that fit snugly over each tub of the galley sink. The bottom surface of these sink covers can be used as cutting boards.

**Important:** Never use counter tops as a cutting board. Nicks and scratches can result.

## Wall Surfaces

The interior coach walls are covered with washable vinyl-clad aluminum and may be cleaned with a mild household detergent or vinyl cleaner. **Do not use abrasive powders or strong solvents; they can damage the vinyl and dull its finish.**

## Fabrics

Interior appointments such as draperies, bedspreads, mattress covers, upholstery, and wall pads are manufactured from high quality synthetic materials and should be **dry cleaned only**. Frequent vacuuming will keep them free of dust and dirt. Minor spills should be cleaned up quickly to avoid staining. The affected area should be blotted, not rubbed, to prevent the stain from working deeper into the fabric.

## Wood Surfaces

Cabinets and other woodwork will retain their luster and beauty if you treat them as you would any fine furniture. Use a good liquid or spray product.

## Carpeting

The wall-to-wall carpeting in your coach will require occasional cleaning due to heavy foot traffic. This should be done only by a professional carpet cleaning service. The carpeting can be cleaned in place, or it can be taken up and cleaned elsewhere. Simply remove the metal strips at the doorsill, roll up the carpet and carry it out.

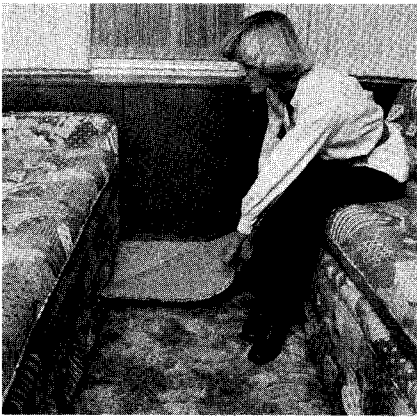

*Carpet Removal*

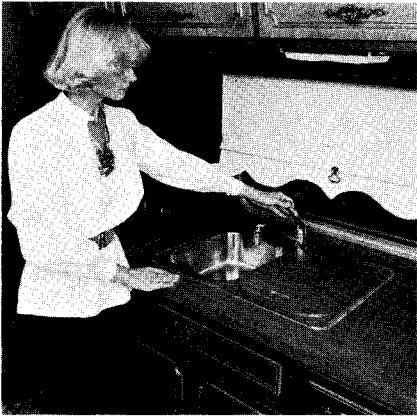

*Stainless Steel Sink*

You can keep the carpet free of ground-in dirt between major cleanings by frequent use of an electric broom or carpet sweeper. If you camp in areas where dirt is likely to be tracked into the coach, you may prefer to take out the carpet ahead of time to keep it from becoming soiled. The floor underneath is covered with vinyl and will not be harmed by foot traffic.

**Note:** Vacuum the vinyl floor before replacing carpeting.

# Monitor Panel

## General Description

The monitor panel is the nerve center of your Avion trailer. It consists of an electronic digital clock with alarm, utility systems monitor, radio/tape player, ammeter, water heater ignition switch, and 12-volt systems kill switch.

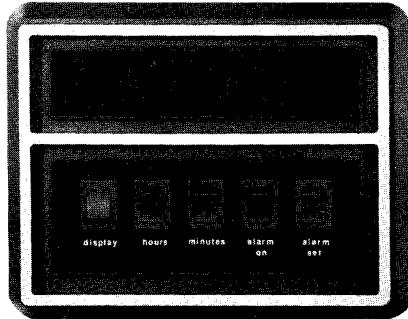

Clock

## Clock

The electronic, digital clock is a 12-hour device and uses a large, easy-to-read LED display, with AM/PM indicators, and built in alarm.

### CONTROL FUNCTIONS

**1. DISPLAY** Turns the display ON and OFF. With the display OFF, all clock functions are normal, and the clock continues to keep time. Other than intermittent use of the alarm, the display uses the largest amount of current. Turning the display OFF except to read the time will help conserve valuable battery energy.

**2. HOURS/MINUTES** These set the time. Press these switches until the correct time appears in the display. Press HOURS first, then MINUTES. Holding the switches down advances the display readout. Release the switches when the correct time is reached. If all power has been disconnected from the clock, as in a power failure, reapplication of power will produce a random display readout. Press the time set switches for the correct time. Be sure to observe the AM/PM indicators when setting the time.

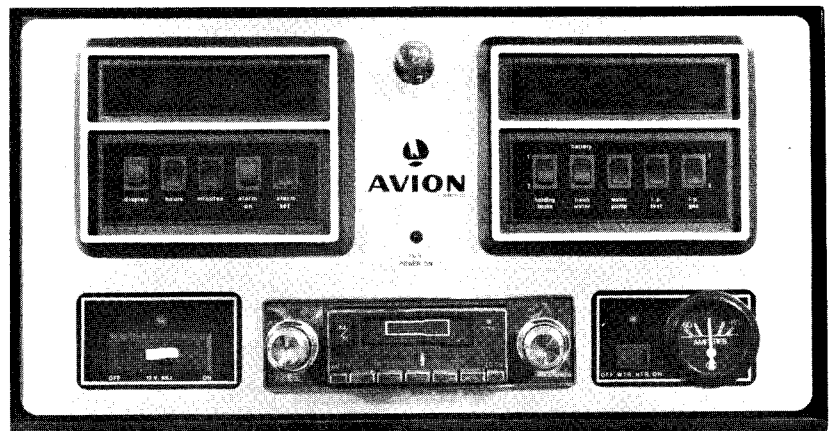

Monitor panel

**3. ALARM ON** This switch activates the clock's alarm circuits. Press this switch up to sound the alarm at the desired time.

**4. ALARM SET** Press this switch, then press the HOURS/MINUTES switches to select the alarm time. Be sure to observe the AM/PM indicators. Release the HOURS/MINUTES switches when the correct alarm time appears in the display. Release the ALARM SET switch. The display will now show the present time. To check the alarm time, press the ALARM SET switch, but don't press the HOURS/MINUTES switches unless you wish to reset the alarm.

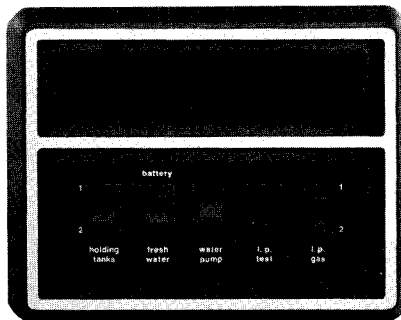

Utility monitor

## Utility Systems Monitor

This panel monitors the level of each of the holding tanks, the level of the fresh water tank, battery condition, checks the level in each of the LP gas tanks, and turns the fresh water pump on and off. Status indicators consist of 1 row of lights labeled "E - 1/4 - 1/2 - 3/4 - F" and measure levels in the holding tanks, fresh water tank, and LP tanks.

Battery condition is displayed by lights indicating "POOR - FAIR - GOOD". The word pump lights up when the water pump switch is in the "ON" position. A red LED indicator mounted between the clock and monitor panel glows when the trailer is plugged into a public utility 110-volt source. The battery is automatically charged when the 12-volt kill switch is "ON" and the trailer is plugged into 110-volt power. The systems monitor and clock are protected by a 12-volt, 20-amp fuse located on the back of the panel.

### MONITOR CONTROL FUNCTIONS

**1. HOLDING TANKS** Press the switch to 1. The level in the solid waste holding tank will be displayed on the status indicators. The display is incremental. With a FULL reading, all indicators will be on. Press switch to 2. This will indicate the level in the gray or rinse water holding tank.

**2. BATTERY/FRESH WATER** Press the switch to BATTERY. Read the battery condition in the display. Be sure all lights, fans, etc. are turned off, and the trailer is not operating on external 110-volt power. If POOR condition is indicated, restrict battery usage to a minimum and recharge the battery as soon as possible. Press the switch to FRESH WATER. the fresh water level in the tank will be shown on the display. (See holding tanks).

**3. LP TEST/LP GAS 1, 2** These switches work together to check the level of gas in the LP tanks. Press the LP test switch, then press the LP GAS 1 or LP GAS 2 switch. Read the level of each tank on the display. Gas supply can also be read on gauges installed in each tank.

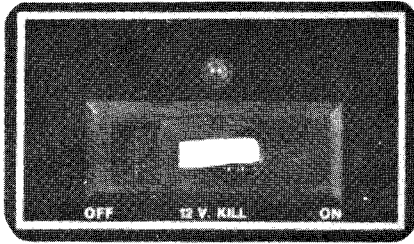

12-Volt kill switch

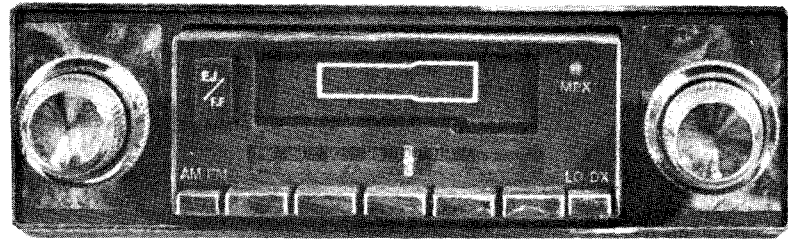

Radio tape player

### 12-Volt kill switch

This switch will completely disconnect the battery from all 12-volt circuits in the trailer including the charging circuit from the converter, and all monitor panel circuits. If you are operating on battery power, this switch must be ON. If you are on external 110-volt power, the switch may be either ON or OFF. When the trailer is not on external 110V power, a green light above the switch indicates that the kill switch is ON and the battery is in the circuit and providing power. The kill switch has a built-in 30-amp breaker that serves to prevent high-rate discharge and prolongs battery life during self contained operation.

### AM/FM /FM Stereo Radio /Tape Player

The radio/tape player with antenna is standard equipment on your Avion. High fidelity loudspeakers are installed to provide high quality, balanced sound through out the trailer. The bedroom speakers may be controlled by a switch located underneath the monitor panel cabinet. Power and speaker leads for the radio/tape player are found behind the monitor panel. The power fuse for the radio is located in the red radio power wire. See the radio manufacturer's literature for details on operation and maintenance.

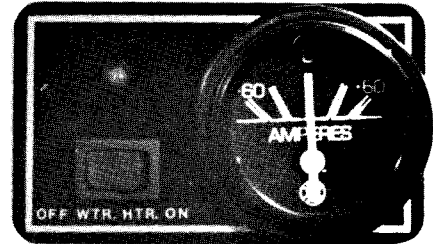

Water heater switch

### Water Heater Switch

**WATER HEATER SWITCH** Push this switch to ignite the water heater or turn it off. The light will glow if the heater's electronic ignition circuit fails to work when you press the switch. If this happens, push the switch to OFF, wait a few seconds, and push to ON again.

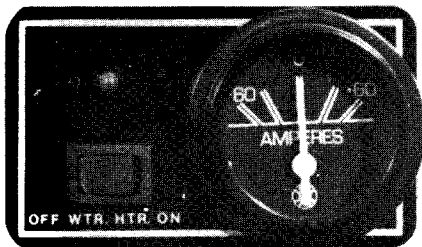

Ammeter

### Ammeter

This indicates the the rate of charge or discharge of the battery. The ammeter, along with the battery condition indicator in the systems monitor display, can help you better monitor and manage your battery needs and uses. The ammeter will not work unless the 12-volt kill switch is ON.

---

## **Power-On Light**

This signal light confirms that the trailer's electrical system is running on 110-volt external power. It also verifies that the AC/DC converter is working and that the on-board batteries are being automatically recharged.

The light is identified on the Monitor Panel as "110V Power on". If it fails to glow while on outside power, check the 3-amp fuse located at the Electrical Control Center.

## **Servicing the Monitor Panel**

To replace light bulbs or fuse, pull the spring-loaded release pin located inside the overhead cabinet immediately to the left of the Monitor Panel. The unit is hinged at the bottom and swings out and down for easy access. A cable holds the Monitor Panel in a horizontal position while it is being serviced.

When closing the Monitor Panel, raise it fully upright until it makes contact with the release pin. Push it gently on upper portion of Monitor Panel with right hand, while pulling out the release pin with left hand until it just clears the edge of the Monitor Panel and allows it to pass. Now let go of the release pin and continue to push Monitor Panel gently until the pin clicks into locked position.

**Model V—10.6 Metres (34')**

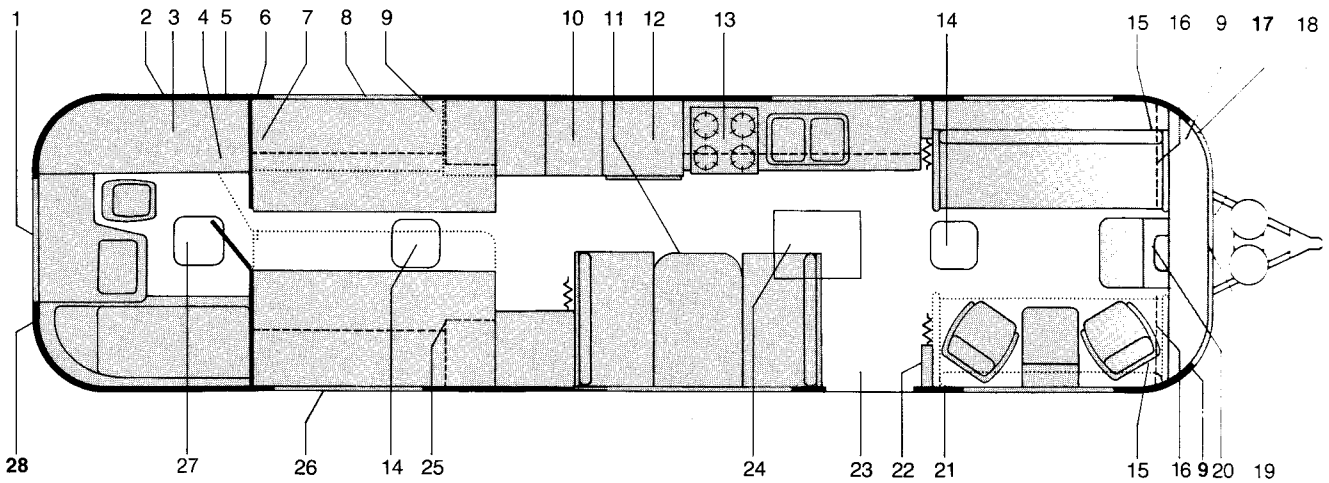

**No. Description Page No.**

1. Trunk _____	32	9. TV Jack _____	73	19. Hook-Up Convenience Light _____	72, 108
2. Utility Convenience Light _____	74, 108	10. Furnace _____	92	20. Monitor Panel _____	54
3. Water Heater _____	95	11. TV Antenna Control (Optional) _____	33	21. Patio Convenience Light _____	72, 108
4. Electrical Control Center _____	72, 108	12. Refrigerator _____	82	22. Switches _____	—
5. 110 Volt Electrical Inlet _____	74	13. Microwave Oven (over range) _____	48	23. Entry Light _____	50, 108
City Water Inlet _____	62	14. Roof Vent _____	55	24. Air Conditioner _____	—
Cable TV Hook-Up _____	33	15. Radio Speaker _____	55	25. Furnace Thermostat _____	92
Sewage Outlet _____	68	16. Reading Light _____	50, 108	26. Exterior Storage _____	32
6. Water Fill Spout _____	62	17. Radio Antenna _____	34	27. Bathroom Exhaust Fan _____	51
7. Water Pump _____	62	18. Batteries _____	72	28. Sewer Hose Storage _____	68
8. Emergency Exit _____	50				

**Model P — 9.1 metres (30')**

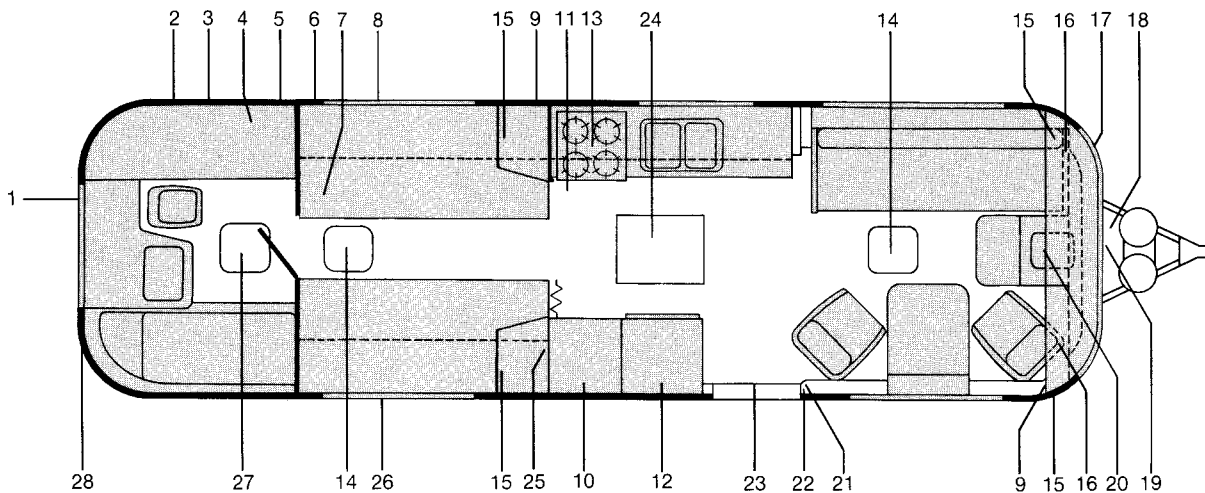



# Systems

60	LPG System
62	Fresh Water System
68	Drainage System
72	Electrical System

# LPG System

Your Avion's gas system consists of two 40-pound capacity LPG bottles, a pipe network for distribution, and various gas-fueled appliances in the coach. The entire system is engineered specifically to operate only with **liquified petroleum gas**, commonly known as LPG.

The two most widely used types of LPG are propane and butane. While your Avion can operate efficiently on either one, we strongly recommend **propane**, because of its ability to remain in a gaseous state down to 40°F. below zero. Butane, on the other hand, will remain gaseous only to 32°F. above zero (the freezing temperature of water), making it impractical for use in cold climates.

## Gas Bottles

The two LPG cylinders are located on the trailer tongue A-frame at the front of the coach. Each is equipped with a gas flow control valve. You will find that one bottle gives approximately three weeks' service in "normal" use. Consumption will increase substantially in cold weather operation, when the furnace is running and large amounts of hot water are used. Extensive cooking can also result in higher than average LPG consumption.

## Automatic Regulator

An automatic regulator is located at the LPG bottles. It has been calibrated at the factory to maintain a pressure of about 6.5 ounces per square inch throughout the system. All appliances have been adjusted to operate most efficiently at this pressure.

**Caution: If any adjustment is required, it must be made by a qualified LPG service mechanic, using special equipment.**

When the gas supply in either bottle becomes depleted, the regulator will automatically switch over to the full one for uninterrupted service.

The valves on **both** bottles must be open to permit automatic changeover. A red indicator will appear on the regulator when this has occurred, and the arrow on the flip-over lever will be pointing to the empty cylinder. Moving the lever to the opposite position will change the **reserve** (full) bottle to the **service** bottle and cause the red indicator to disappear.

**Note:** If the system is under heavy load, especially in cold weather, the **service** bottle pressure may drop enough to indicate "**reserve**," even though it still contains fuel. Do not consider the service bottle exhausted until the red indicator appears under a **light** load.

The amount of fuel remaining in each tank at any given time can be verified by checking the Monitor Panel LPG system status lights or by visual inspection of the gauges on the bottles.

## Replacing the Gas Bottles

1. Shut off the gas flow control valve on the bottle being replaced.
2. Remove gas level sensor gauge wires, then disconnect the gas line by loosening the lock nut with a wrench. The nut is **left** threading; therefore, turn it **clockwise to loosen and counterclockwise to tighten**. Tape the end of the gas line closed, even if it will be out of service for only a few minutes. Insects attracted into the tubing can often plug the line.
3. Loosen the retaining clamp nut enough to provide clearance, then remove tank. It should be moved at least 25 feet away from the trailer before being filled. Observe caution (no smoking or open flames in the area).
4. Reinstall the gas bottle by first connecting the gas line, then tighten the retaining clamp securely and turn on the flow control valve.
5. Test for gas leaks at bottle gas line connection.

## Reactivating the LPG System

Special steps must be taken to restore service in the event both cylinders have been depleted, or if your LPG system has not been used for a long period, thereby allowing air to enter the gas lines. If this happens, gas pressure must be used to force out the air before relighting the pilots.

1. Fill the gas bottles and reinstall if gas supply has been depleted.
2. Shut off all valves and gas appliances.
3. Open LPG bottle flow control valves.
4. Test for gas leaks at bottle gas line connection. (See next section.)
5. Starting with the appliance **nearest** the front of the coach (where the LPG tanks are located), turn on the pilot valve and hold a match to it until it ignites and holds a steady flame. Then move on to the next-closest appliance, and so on, until all pilots have been relighted.

## Testing for Gas Leaks

Before turning on the LPG system, make certain that appliance valves are closed, unconnected outlets are capped, and gas connections are tight. All gas fittings, except those at individual appliances, are located outside the coach for safety and serviceability. Several connections are underneath, where the main LPG line branches off to supply the separate appliances. These gas lines and fittings, as well as fittings at the appliances, should be inspected and

tested periodically for possible damage and leaks.

1. Close all appliance valves and cap unconnected outlets.
2. Turn on gas supply at LPG bottle flow control valves.
3. Brush or spray a biodegradable soap solution over all fittings and any damaged areas in the gas lines. **Do not use products containing chlorine or ammonia.**
4. Look for the appearance of soap bubbles in the area being tested. If they grow larger, there is a gas leak present.
5. LPG is intentionally "marked" with a discernible odor. **If it is detected inside the trailer, immediately extinguish all open flames, including pilot lights, and test for leaks.** Check out every location in which there is a valve, fitting or possible gas line damage.
6. Turn off the LPG supply at the gas bottle flow control valves if a leak is detected but cannot be traced to its source. Consult your Avion dealer or a competent gas appliance service center. **Do not use the system again until the leak is pinpointed and eliminated.**

## Maintenance

The only maintenance you should perform personally consists of testing for leaks on a regular basis and refilling the gas bottles. All other service functions must be handled by a qualified service technician to insure against potentially serious accidents.

**Important:** It is illegal in some states to leave the gas bottle valves open while traveling. Check with proper authorities and observe local laws.

**Caution:** Always extinguish all gas appliance pilot lights before refueling your tow vehicle.

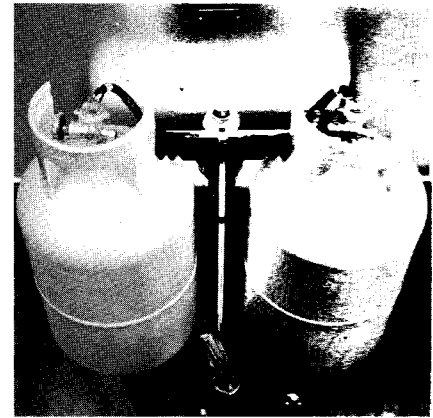

LPG Bottles and Regulator

# Fresh Water System

Your Avion is outfitted with a system designed to provide fresh water service from a city hookup or from the trailer's own self-contained supply. The system consists of a water pump, water heater, water purification system and pressure regulator, and all of the faucets, fixtures and plumbing required to deliver the water on demand.

## Fresh Water Holding Tank

The molded plastic fresh water 65-gallon holding tank is located below the coach floor at its axles. A hot air duct running from the forced air furnace to the water tank compartment provides heat for cold weather operation. Access to water tank fittings is through a cutout in the trailer floor. Water level can be checked instantly on the Monitor Panel (see page 54).

## Fill Spout

The fresh water holding tank is filled through a fill spout located behind a locking door on the outside of the coach. Simply swing down the hinged door and pull out the filler spout far enough to insert water hose. A bypass line is also provided, enabling you to fill the tank while the trailer is connected to an outside water supply. The bypass valve is located in the hose storage compartment and is accessible from outside the trailer. During the filling procedure, check fresh water holding tank level at the Monitor Panel or observe discharge from the fill spout vent. Turn off bypass valve when tank is full.

**Caution: For proper venting, always open the locking access door and pull out the fill spout before opening bypass fill valve.**

## Water Pump

The automatic water pump is mounted on the floor near the fresh water holding tank access cutout. It has been designed specifically for use with self-contained, multi-fixture water systems, and is self-priming for operation under any conditions. The pump will run even when dry, thereby preventing possible burn-out. A built-

*note*  
in discharge valve insures against back-flow into the fresh water holding tank when the system is hooked up to an outside source. The unit's hydraulic pulsation dampener and large vibration-absorbing pads provide smooth, quiet operation.

The water pump is an automatic "demand" type. It instantly begins operating when a faucet is opened, pumping a constant three-gallons-per-minute flow from fresh water holding tank to spigot. The pump automatically shuts off when the faucet is closed. Water pressure in the line must be at least 16 psi for the pump to function properly. After the pump system has been out of use for an extended period, the pressure must be brought up to minimum requirements or the pump will not operate.

Activate the water pump using the following procedure.

1. Check level in fresh water holding tank at Monitor Panel.
2. Clean the filter located in water line between pump and fresh water holding tank. Disassemble filter, remove the screens and clean them. Also clean all faucet aerators.
3. Open faucets on galley sink, bathroom sink and shower/tub. Each has a single control knob, which should be set midway between the maximum hot and cold settings to assure equal flow from both lines.
4. Turn on water pump switch at the Monitor Panel.
5. Close faucets when they start delivering a steady stream of water. Rotate control knob to **maximum hot setting** before turning off.
6. Check water pump to make sure it shuts itself off after the last faucet has been closed.

The water pump is now ready for automatic operation. It will start up whenever a faucet is opened and shut down when the faucet is closed.

**Important: When traveling, always turn off the water pump at the Monitor panel. This will eliminate the possibility of water flowing from any faucets that may have been left open inadvertently or opened during travel.**

The water pump, as any other component in the Avion fresh water system, can be damaged by sub-freezing temperatures. Refer to **Winter Storage** section, page 106, for proper steps to be taken if you do not plan to travel during cold weather.

Minor malfunctions in the water pump may be corrected by using the trouble-shooting guide on page 69. Never attempt to service the pump without first turning off the power at the Monitor Panel and opening all faucets to relieve pressure in the water system.

### **Water Heater**

The six-gallon-capacity gas water heater features pilotless electronic ignition. It is actuated by a switch on the Monitor Panel. A signal light on the Monitor Panel glows automatically in the event of a malfunction in the ignition system. See **Appliances** section, for operating instructions.

### **Water Purification System**

The water purification system is located in the cabinet below the galley sink and is connected to the **separate galley supply faucet**. It is designed to remove a variety of impurities, including suspended particulate matter and unpleasant odors and tastes, but it is not intended to eliminate bacteria. Such contamination can be treated by adding 1/6-ounce liquid chlorine bleach per 10 gallons of water to the fresh water holding tank.

The water purification system will keep water sparkling clear for cooking and drinking to the limit of

the filter life. Inspect the filter cartridge periodically for accumulations of foreign matter that might impair water flow. Replace the cartridge when flow becomes noticeably restricted or once each year.

1. Shut off water by rotating the cartridge housing valve handle **counterclockwise** as far as it will go.
2. Rotate the colored ring all the way to the **left**. It will drop approximately  $\frac{5}{8}$ -inch.
3. Lift the cartridge slightly and turn it to the **left** until it can be disengaged.
4. Lower cartridge to disconnect it from the ring, and discard.
5. With the colored ring still in the lowered position and turned all the way to the left, align the cutout under label on ring with the lug on the new cartridge.
6. Insert new cartridge upward into ring as far as it will go.
7. While holding colored ring steady, turn cartridge to the **right** until it stops. Do not force.
8. Turn colored ring to the **right** until it drives the cartridge up into the head.
9. Lock the ring in place and turn on water by rotating purifier valve handle **clockwise**. Make certain that the handle leg engages the ring locking nut to assure correct operation.



*Water Tank Fill Spout*

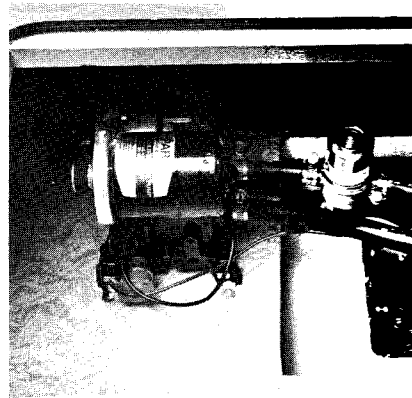

*Water Pump*

## Water Pressure Regulator

All Avion models feature an in-line water pressure regulator. It maintains a safe and constant water pressure in the on-board fresh water system while connected to an outside water supply. Sometimes these sources are subject to wide pressure variations, which can damage plumbing or water delivery components. The water pressure regulator safeguards the trailer's water system in the event of such variations.

## Faucets

The fixtures are triple chrome plated for long-lasting beauty and ease of care. All faucets turn water on and off and adjust mixture to desired temperature. The shower/tub faucet also features a pushbutton to divert water from the bathtub spout to the shower head.

See **Interior** section, page 50, for additional information on faucet operation.

## Operating the Fresh Water System

The water pump is turned on to operate your trailer's stored water system. A switch is provided on the Monitor Panel for this purpose. **The pump is not required** if you are hooking up to a city water supply.

The city water fill connection is located at the water hose storage compartment on the road side of the trailer. A short length of hose, complete with standard garden hose connector, is permanently attached to the trailer water system. The coupling should remain outside the compartment door whenever a standard garden hose is attached. A plug is provided to permit closing the end of the hose when it is not in use.

When using outside water sources for any lengthy period, you should drain the fresh water holding tank, then refill it when you disconnect from the external supply and are ready to get under way. Make certain that the fill spout is closed and the access door locked before traveling.

## Water Sanitation

In addition to adding small amounts of chlorine as described under **Water Purification System**, we recommend you observe the following measures to assure complete sanitation of your potable water system...whether it is brand new, or has been out of service for a lengthy period, or has possibly become contaminated.

1. Turn on water pump switch at the Monitor Panel and drain the fresh water holding tank. This can be done either by opening any faucet inside the coach or by opening the holding tank drain valve, which is located under a cutout in the coach floor (see photo) on the **Road Side** at the rear, under either the bed, or dinette seat, or the optional side vanity, depending on the floor plan.
2. Prepare a solution of ¼-cup household liquid chlorine bleach (5% sodium hypochlorite) to one gallon of water for each 15 gallons of holding tank capacity.
3. Close drain valve and faucets and pour chlorine solution into the fresh water holding tank filler spout, then complete filling with plain water.
4. Open sink and tub faucets individually until water flows steadily, then turn off. This will purge any air from the lines.
5. Top off holding tank with plain water and wait three hours.
6. Drain and flush the entire system with potable water (drinking quality) by opening fresh water holding tank valve or sink and tub faucets.
7. Remove any lingering chlorine taste or odor by preparing a solution of one quart vinegar and five gallons of water and pouring it into the fresh water holding tank filler spout, after closing drain valve and faucets. The solution should be allowed to agitate in the tank for several days by the normal motion of the trailer.
8. Drain the tank again and flush with potable water, with all sink and tub faucets open, then close tank valve and faucets and refill. The system is now sanitized and ready for use.

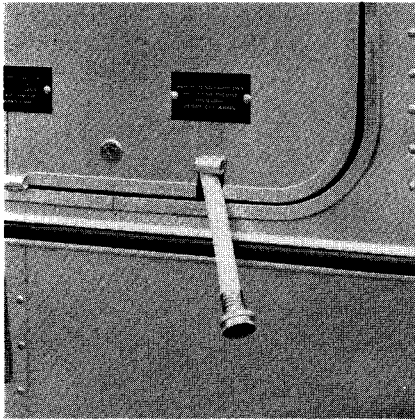

City Water Connection

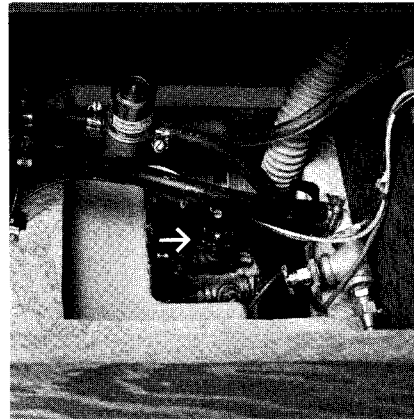

Water Tank Drain Valve

## Trouble-Shooting

Symptom	Cause	Remedy
Pump operates but no water flows through faucet.	Low level in fresh water holding tank.	Fill tank.
	Suction line clogged or kinked.	Check for obstructions.
	Air leak in suction line.	Repair or replace line.
	Loose suction line clamps or fittings.	Tighten all hose clamps and fittings.
Pump cycles on and off when faucets are closed.	Leak in plumbing.	Check for leaks and reseal.
	Defective toilet slide valve.	Replace valve.
	Internal leak in water pump.	Repair or replace pump.
	Outlet valve not sealing.	Check for proper seating and sealing.
Rough, noisy operation and excessive vibration.	Intake line restricted, kink in suction line, or fittings too small.	Check for line obstructions or restrictions and correct them. Change fittings if too small.
	Faulty pulsation dampener.	Replace dampener.
	Screws loose at pulleys or connecting rod.	Tighten screws.
Pump does not start when faucet is opened.	No electrical power to pump.	Check Monitor Panel switch and fuses.
	Outlet line clogged or kinked.	Remove obstruction.
	Defective pressure switch.	Replace switch.
Pump does not shut off when faucets are closed.	Fresh water holding tank is empty.	Fill fresh water holding tank.
	Outlet valve not sealing.	Check valve for proper seating and sealing.
	Low electrical power to pump.	Recharge batteries.
	Air in system.	Open all faucets until steady stream of water flows.
	Faulty pressure switch.	Replace switch.
	Air leak in filter.	Check filter seal and hose clamps.

**Water System Diagram**

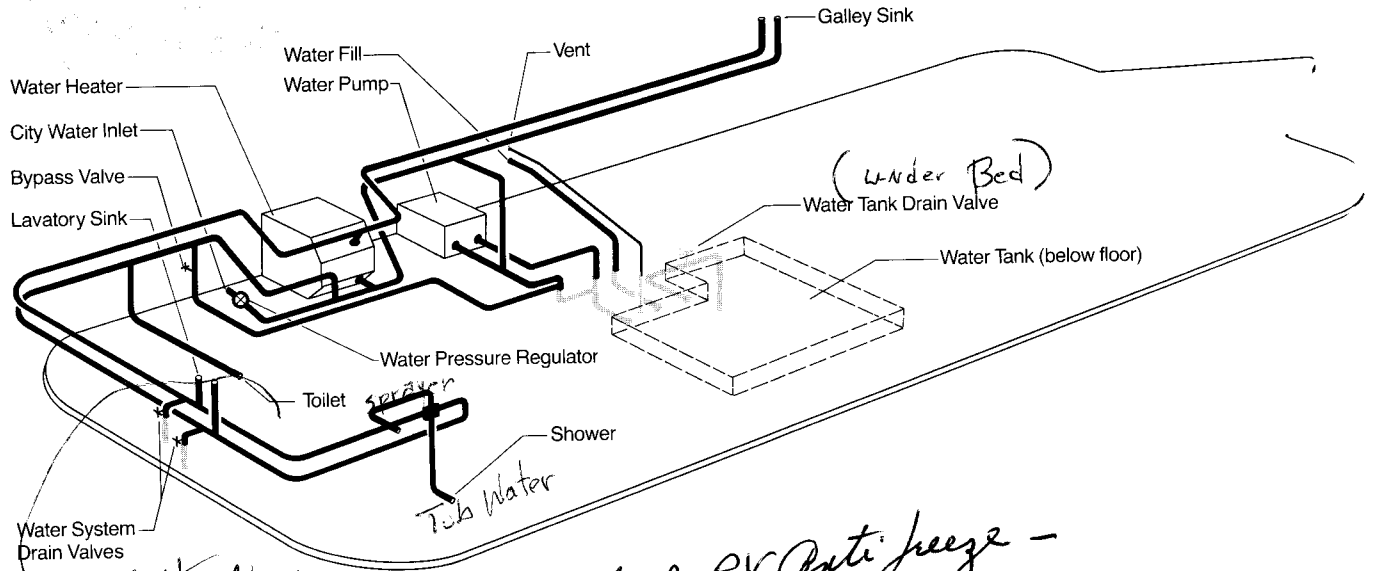

Note *for bottom of sink dead*  
 To winterize 3 gals of RV Anti-freeze -  
 On Pump - Unscrew the outside tube on the pump, this is the  
 suction side! marked with black tape. Use black plastic cap (do  
 not have round hose) See page 103 for details.  
 Put at least 1 cup in toilet, kitchen sink, +  
 bathroom sink + tub.



# Drainage System

The drainage system in your Avion consists of two major components: a 30-gallon-capacity rinse water holding tank, which stores water that has been used in the sinks and shower/tub; and a 40 gallon waste holding tank, which collects waste matter from the toilet.

The rinse water and solid waste holding tanks are located adjacent to each other on the road side of the coach near the back end. They discharge liquids and solid waste through a single sewage outlet, also located at the rear road side, behind a hinged door at the lower edge of the coach. This compartment also houses separate "T" handle dump valves for the rinse water and solid waste holding tanks.

## Hooking Up to City Sewer Inlet While Camping

1. Remove sewer hose from the rear bumper storage compartment.
2. Unlatch sewage outlet door and let it swing down.
3. Remove the drain cap and connect hose by pressing bayonet fitting onto the sewage outlet and turning clockwise until secure.
4. Connect other end of sewer hose to the city hookup inlet.
5. Open and drain solid waste holding tank, if necessary (see next section).
6. Open rinse water holding tank dump valve by pulling straight out on the "T" handle.
7. Swivel sewage outlet down, disconnect sewer hose from outlet, then close and latch the access door.
8. Reconnect sewer hose through opening in access door.

**Important: The solid waste holding tank dump valve should never remain open, even if you are camped where a city sewer hookup is available.** The volume of water used with each flush may not be adequate to fully discharge solid wastes, resulting in an unpleasant build-up that is difficult to remove.

If, however, the dump valve is left open, fill the toilet bowl with water before flushing solids, to insure adequate flow. Repeat if necessary. Depress the small toilet pedal first to fill bowl, then depress large pedal to flush.

## Emptying the Solid Waste Holding Tank While Camping

1. Run 5-6 gallons of clear water into the solid waste holding tank before using, and add an appropriate amount of chemical.
2. Disconnect sewer hose from trailer sewage outlet, lower the door for access to dump valves, and reconnect the sewer hose.
3. Open solid waste holding tank dump valve by pulling out on the "T" handle. Close valve when tank has been completely drained.
4. Fill solid waste holding tank part way (5-6 gallons) and repeat draining procedure. Make sure solid waste holding tank dump valve is closed following drainage.
5. Disconnect sewer hose from sewage outlet, close and latch access door, and connect sewer hose.

## Overloading the Solid Waste Holding Tank

Check the level in the solid waste holding tank often enough to prevent filling it completely. A system status light on the Monitor Panel will tell you the level on command. See **Interior** section, page 54. If this holding tank becomes too full, the toilet will not drain. Since the toilet uses less than

one pint of water for an automatic flush, the tank can easily accommodate the requirements of two adults for a period of several days. This can be extended to more than a week by using the water saver package, in the event you are camping where no sewer facilities are available.

### **Overloading the Rinse Water Holding Tank**

This tank accumulates rinse water from the galley sink, bathroom sink, and shower/tub. If your coach is connected to a city sewer inlet with the rinse water holding tank dump valve open, the tank will drain continuously and cannot overload. If you are camping where no such facilities are offered, you should store the rinse water until a sanitary dump is reached. The level in the rinse water holding tank can be observed at the Monitor Panel. See Interior section, page 54.

#### **Warning:**

**Holding tanks are enclosed sewer systems, and as such must be drained into an approved dump station. Both toilet and grey water holding tanks must be drained and sanitized regularly to prevent buildup of harmful or toxic materials.**

### **Shared Hookups**

You can share sewage facilities with another trailer through the use of a special "Y" fitting, available from recreational vehicle stores. The stem of the "Y" connector should be attached directly to the city inlet. Connect the sewer hose from each trailer to one of the legs of the "Y" fitting. Never empty the rinse water or solid waste holding tanks from both coaches simultaneously. If the other trailer unhooks from the "Y" fitting, remove it and reconnect your sewer hose directly to the sewer inlet.

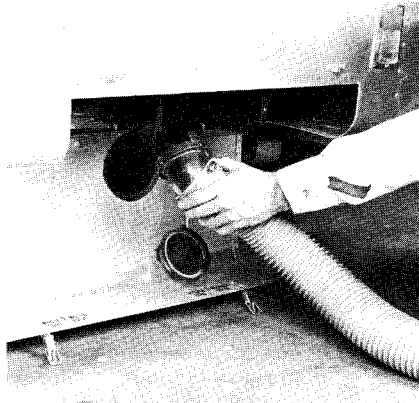

*Sewer Hose Connection (Dumping)*

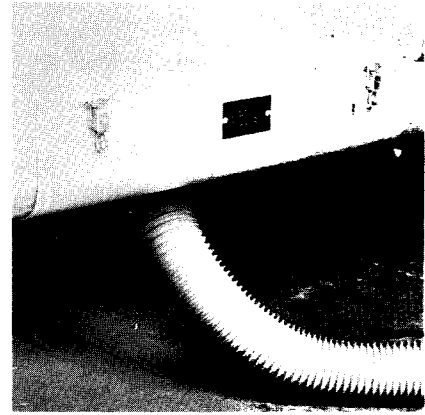

*Sewer Hose Connection (In a Park)*

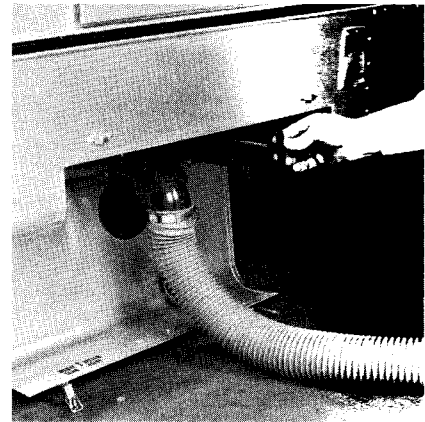

*Waste Holding Tank Drain Valves*

## Disconnecting from City Sewer Hookup

Always observe the following procedure before disconnecting from a city sewer inlet in preparation for travel.

1. Empty the solid waste holding tank and close its dump valve.
2. Empty the rinse water holding tank and close its dump valve. This will help flush the sewer hose. If the rinse water holding tank dump valve had remained **open** while you were connected to a city sewer inlet, first close it, then fill tank by opening any water faucet inside the coach. The rinse water holding tank dump valve can now be opened to flush the sewer hose, then closed.

**Important:** Always drain the solid waste holding tank first; then drain the rinse water holding tank.

3. Uncouple sewer hose at the trailer sewage outlet and flush with plain water. Then disconnect other end of hose from the city sewer hookup and stow it in the rear bumper compartment.
4. Replace drain cap on the trailer sewage outlet to prevent accidental dumping, then swivel the outlet upward into its "traveling" position.

**Important:** The sewage outlet cap must be in place while traveling, but must be removed before opening the dump valve on either tank.

5. Close and latch the sewage outlet/dump valve access door.

## Dumping at a Sanitary Facility

The same basic procedures outlined earlier in this section should be followed when using a sanitary dumping facility. Remember to empty the solid waste holding tank first and the rinse water holding tank second. When you are hooking up to a sewer inlet only long enough to drain the tanks, it is not necessary to swivel the trailer sewage outlet down and run the sewer hose through the access door hole. Simply connect the sewer hose to the sewage outlet in its "traveling" position and leave the access door open while the tanks are being emptied.

## Toilet Operation

The Thetford Aqua Magic® toilet in your Avion is pedal-operated and has a sliding, self-cleaning, positive-seal blade to prevent solid waste holding tank odors from escaping into the coach. The toilet can be operated in four different ways, depending on the amount of water you desire to use.

### Automatic Flush and Refill

1. **Depress both foot pedals** (located side by side at the right front of the toilet). This opens the slide valve and releases solid and liquid waste into the holding tank. The **small** pedal turns on the water; the **large** pedal actuates the slide valve.
2. **Keep both pedals depressed approximately one to three seconds**, until water begins to swirl in the bowl and rinses it. This time lag also fills the rim storage, which will subsequently refill the bowl and then allow it to drain.

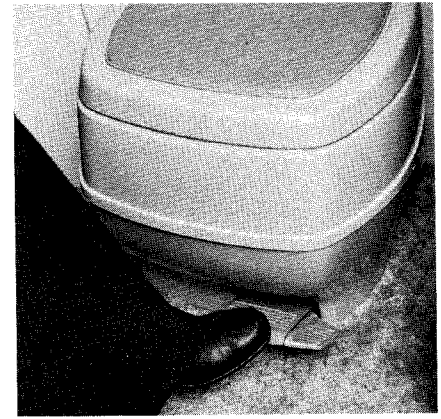

Toilet Pedal Operation



Toilet Hand Spray

3. **Release both pedals** to close the slide valve and stop the flow of fresh water. The rim storage will then drain into the bowl and refill it.

#### Flushing with Slide Valve Open for Minimum Time

1. **Depress the small (right) pedal only.** Hold it down until water begins to swirl in the bowl, then release it.
2. **Depress the large (left) pedal** to open the slide valve and discharge waste into the holding tank. The water will immediately swirl into the bowl to provide rinsing action. When the **large** pedal is depressed, it automatically operates the **small** pedal, as well. However, the time lag in the flush is eliminated because the **small** pedal turns on the water flow, and the rim storage is filled when **both** pedals are depressed.
3. **Release both pedals** to close the slide valve and stop the flow of fresh water. The bowl refills automatically from the rim storage.

#### Flushing with the Water Saver Package

1. Hold the hand spray unit (left side of toilet) directly over the bowl and push the thumb button.
2. **Depress both foot pedals.** This will open the slide valve, drop waste matter into the holding tank, and automatically release fresh water through the hand spray into the bowl.
3. Spray the bowl clean, then release the button to shut off water at the spray head.

4. **Release both pedals** to close the slide valve and to stop the flow of water through the hand spray hose.

5. Make sure the slide valve is seated properly. Be especially careful to flush bathroom tissue completely, otherwise it might prevent the valve from closing fully and sealing.

#### Flushing with the Hand Spray Only

1. **To flush liquid waste only,** wet the bowl with the hand spray before and after use. More water is required to rinse a dry bowl than a wet one.
2. **To flush liquid and solid waste together,** have just enough water in the bowl to allow for flotation of solid material. Depress the **large** foot pedal to open the slide valve and discharge waste into holding tank. Keep the valve open while rinsing bowl with the hand spray, then release the pedal. The toilet is again ready for use.
3. To refill the bowl, depress the **small** pedal until desired water level is reached, then release it.

The Aqua Magic toilet does not require any maintenance or lubrication to provide reliable service.

#### Drainage Tips

1. Never attempt to dispose of face tissues, paper towels or other materials with "wet strength" through the toilet. They do not dissolve easily and can clog the solid waste drainage system.
2. Use only water and approved chemical additives in the drainage system to avoid possible permanent damage and costly repairs.
3. Take precautions when using your trailer during cold weather. A permanent-type antifreeze may be added to the rinse water holding tank and solid waste holding tank, but never use fluids that can cause damage to the drainage system. See **Winter Storage** section, page 106, for more information.
4. Use mild household cleaners to keep the drainage system fresh and sanitary. Regular toilet bowl products can be used, but they must be flushed through the system within four hours. They should never be left in the solid waste holding tank for an extended period, because such products have an adverse effect on holding tank chemicals.

# Electrical System

Electricity for your Avion is furnished by on-board 12-volt batteries or by 110-volt external power. Some of the 110-volt current is fed to the AC/DC power converter, which in turn supplies the trailer's 12-volt system when it is not operating from the self-contained batteries.

## Electrical Control Center

The heart of Avion's 110-volt and 12-volt power systems is the Electrical Control Center. It incorporates the latest solid state technology and advanced features to insure an uninterrupted source of electricity, whether you are operating from an external 110-volt hookup or the on-board 12-volt batteries.

The Electrical Control Center is located in the bathroom, behind a storage cabinet door. It consists of three basic modules designed for years of reliable service.

**1. AC/DC Power Converter.** This module converts outside 110-volt alternating current to the 12-volt power necessary for operation of interior 12-volt lights, appliances, fans, water pump and outlets when they are not drawing current from the trailer's 12-volt batteries. The converter unit's components include a low-hum power transformer to reduce current from 110-volt AC to 12-volt AC, and solid state rectifiers or diodes to change the 12-volt AC to 12-volt DC (similar to battery current). The power converter cord plugs into a 110-volt outlet built into the Electrical Control Center.

**2. 12-Volt DC Distribution Panel.** This module supplies current to 12-volt outlets, water pump, water heater and furnace electronic ignitions, fans, and most interior lights. It contains individual fuses to protect all 12-volt circuits leading from the power converter (see page 113 for fuse sizes). The DC panel's other components include a transfer relay that automatically switches the electrical system from battery power to converter operation when the power is plugged into a 110-volt source, and a removable printed circuit board.

If the printed circuit board should malfunction, it can be replaced without exchanging the entire power converter. First remove the face plate, which is attached by two slotted hex head screws located above the 12-volt fuses. Disconnect the white nylon plug and remove the two retainer screws holding the circuit board in place. The board can now be lifted out and replaced with a new one.

**Caution: Disconnect the power cord from 110-volt supply before attempting to perform any service work on the Electrical Control Center.**

**3. 110-Volt AC Distribution Panel.** This module delivers electricity to refrigerator (while operating on 110-volt current), power converter, air conditioner, and 110-volt receptacles.

The panel is equipped with a 30-amp main circuit breaker and a series of branch circuit breakers. In the event of a 110-volt short or overload, a branch circuit breaker will automatically trip and cut off power. The breaker switch will be positioned halfway between "on" and "off" at this time. To reset, move breaker switch all the way to "off," then all the way back to "on." If it trips again, check exposed wiring for breaks and disconnect any appliances that might be overloading the circuits. The circuit breaker will not trip again if the problem has been corrected.

## Battery Charger

Whenever the trailer is connected to an external 110-volt source, the power converter will automatically bring the batteries up to full charge and then reduce to a small trickle charge to keep them in that condition. You can verify battery status by observing the "Charge Sentinel" light on the Electrical Control Center. It will glow continuously while the batteries are being charged, and then flash on and off when 90% of charge capacity has been reached. The light will continue to blink several times per second as long as the batteries are at least at 90% of full charge, and will again glow continuously when the level drops below this point.

**Important:** The "Charge Sentinel" will not function without batteries in the trailer or when the power converter is not hooked up to a 110-volt source.

### Automatic Power Relay

The Electrical Control Center features a transfer relay, which automatically switches the interior electrical system from battery power to outside power when you plug into a 110-volt supply. When the power cord is connected, a clicking sound will indicate that the transformer has been energized and all 12-volt systems are operating directly from the converter.

The transformer relay will automatically switch back to the battery mode when the power cord is unplugged, bypassing the power transformer. **Always operate the electrical system on 110-volts whenever possible, in order to conserve your batteries and keep them fully charged for use when no outside power is available.**

The power converter in this trailer is equipped with thermal overload protection. In the event of an overload it will automatically switch to battery power. When the converter cools it will switch to outside power. This condition can be noticed by the clicking of the converter relay. If this condition occurs, immediately turn **off** one or more lights to eliminate the cycling of the overload switch and keep the 12-volt AC system operating on outside power.

### Electrical Outlets

Receptacles for 110-volt use (toaster, blender or similar appliances) are located throughout the coach interior. One is also situated inside a storage compartment, near the back end of the trailer on the door side. This outlet is convenient for use with electrical rotisseries, radios, television sets and other appliances.

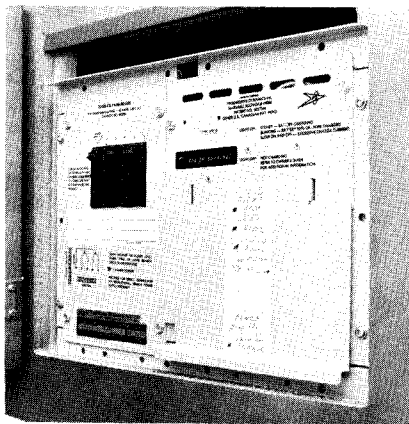

Electrical Control Center

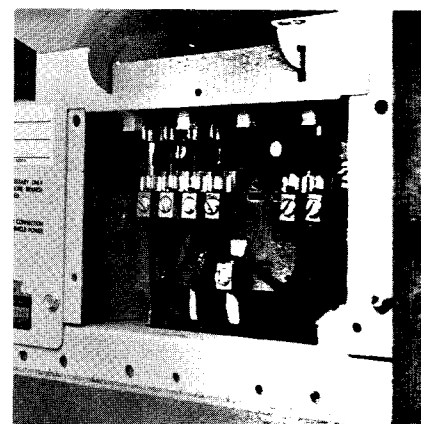

12 Volt Fuse Panel

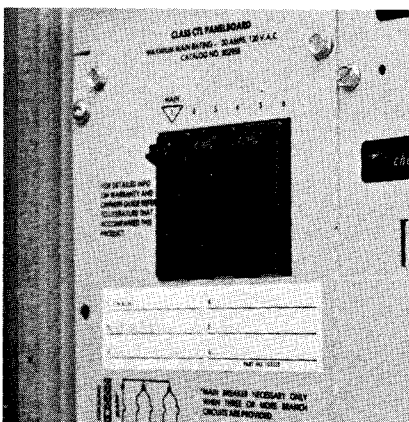

110 Volt Circuit Breakers

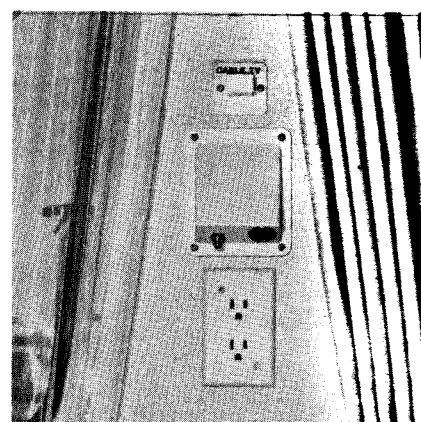

110 & 12 Volt, TV & Cable TV Receptacles

Receptacles for 12-volt use are also found at each television antenna jack.

**Note:** 110-volt outlets will function only when the coach is connected to outside power; 12-volt outlets will operate regardless of power source.

## Power Cord for 110-Volt Hookup

A 25-foot power cable for city hookup is stowed in the locking utility compartment on the road side of the trailer. Pull out the necessary length of cord and plug into 110-volt power source, making certain that the connection is secure. Position the cord so that its weight does not pull the plug loose.

Keep the utility compartment door closed and locked while outside power is being used. Slide the cord into the adjustable slot in the door.

**Caution: Never attempt to plug into 220-volt power. The electrical wiring and safety devices built into your Avion coach were not designed to handle high-level voltage, which may cause extensive damage and pose a personal safety hazard.**

## Exterior Lighting System

The electric brakes and all exterior lights (except patio, utility and hookup fixtures) operate on a separate 12-volt circuit from the tow car. They are also fused at the car. Dual fixtures on the back end of the coach, left and right, pair turn signal/brake lights (outboard) and tail/backup lights (inboard). Five clearance lamps are located at the top edge of the coach on the front end (amber), and five on the back end (red).

The patio light (white) is to the right of the main door and operates from an inside wall switch. The utility light (white) is located below the utility door and is operated by a switch inside the compartment. The hookup light (white) is located near the LPG bottles at the front end of the coach, and operates from a switch inside the entry door. See page 108 for bulb sizes.

## 7-Way Connector Power Cable

Power to the trailer's exterior 12-volt lights and electric brakes is provided through a 7-way connector cable from the tow car battery to the trailer hitch connector plug.

Take the following precautions to prevent battery drain.

1. Uncouple the 7-way connector cable when camping without 110-volt hookup for extended periods. This will keep the 12-volt appliances from drawing power from the tow car battery while it is operating on 12 volts.
2. Do not lay the trailer hitch connector plug in water; it will short and drain the trailer battery.

**Caution: Tow car wiring for the 7-way connector cable should be done only by a qualified installation technician to assure that adequate wire sizes are used for all circuits.**

## Charging Trailer Battery from Tow Vehicle

The exterior 12-volt electrical system provides a backup method for keeping the on-board trailer battery charged between hookups to 110-volt power. The 7-way connector that supplies current from tow car to exterior coach lights and electric brakes also charges the trailer battery while the car's engine is running. The black wire of the connector (No. 4 terminal) attaches to the positive terminal of the trailer battery if the tow car has a standard "negative ground" system.

## Battery

The 12-volt electrical energy for your trailer can be provided either by the on-board storage battery or by the AC/DC power converter, when connected to a 110-volt outside supply.

The battery box is designed to accept two Group 24, 85-ampere hour batteries. If two batteries are used, they should be connected in parallel to give greater reserve energy so that if one battery should fail the other will continue furnishing power to the limits of its capacity. Check the inoperative battery with hydrometer to verify its condition. If defective, remove it from the circuit and allow the other battery to operate alone. **Always reconnect batteries properly to avoid damage.**

The trailer battery is protected by a 40-amp in-line fuse located at the battery. If you are connected to 110-volt power and the battery does not charge, and the ammeter on the Electrical Control Center shows no charge, it indicates that the battery fuse has blown.

The battery should be checked periodically to verify that it is fully charged. In addition to observing the Monitor Panel and Electrical Control Center ammeter for condition, you should also use a hydrometer to test the individual cells. The battery is located inside a covered compartment on the trailer tongue A-frame, behind the LPG bottles. A fully charged battery will have a specific gravity reading of 1.260 to 1.280 at 80° F.

The electrolyte level should always cover the tops of the plates inside battery casings. **Permanent damage may occur if the plates are not fully submerged.** You can bring the electrolyte up to the correct level by adding filtered or distilled water. **Always check every cell when examining the battery.** Evaporation rates may vary from one to the other.

**Caution: Exercise proper care when checking battery. It contains strong, concentrated acid, which can burn holes in clothing and cause skin irritation. If electrolyte should splash accidentally, rinse immediately and generously with an acid-neutralizing solution of baking soda or ammonia.**

Inspect the wires and battery terminals for corrosion and poor connections, both of which can rob battery of power. **Again, be careful, since the corrosion is actually concentrated acid deposits.** Keep terminals clean by wiping them with a cloth saturated in a baking soda or ammonia solution. Heavy corrosion deposits can be removed from the terminals with a stiff wire brush. After cleaning, make sure all connections are snug and then apply a light coat of grease to protect them from further corrosion.

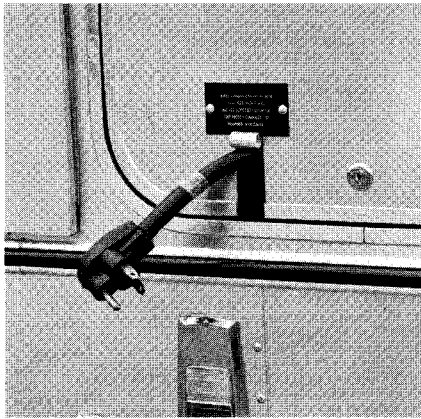

110 Volt Power Cable

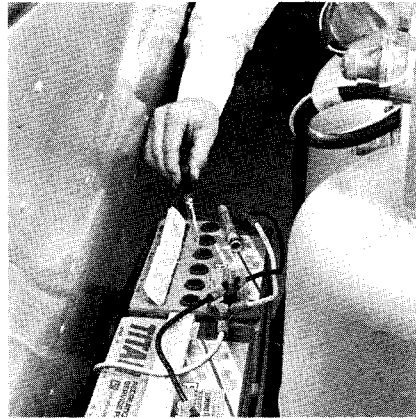

Battery Hydrometer Check



Battery In-Line Fuse

## 7-Way Connector

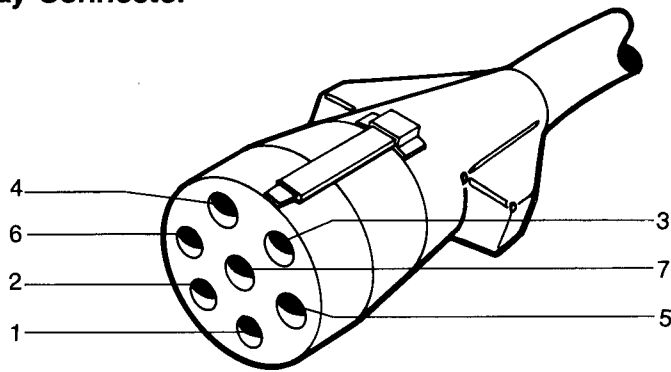

*white - ground*  
*blue - hot*  
*green - tail and clearance lights*  
*black - battery charging by tow car*  
*red - left turn signal and brake light*  
*brown - right turn signal and brake light*  
*yellow - back up lights*

Terminal Number	Wire Color	Connects To
1	White	Brakes (ground)
2	Blue	Brakes (hot)
3	Green	Tail and clearance lights
4	Black	Battery charging by tow car
5	Red	Left turn signal and brake light
6	Brown	Right turn signal and brake light
7 (center post)	Yellow	Back up lights

To prevent damage to the battery, never allow it to become fully discharged. **Specific gravity should not be permitted to drop below 1.150.** The surest way to avoid battery drain is to use an external 110-volt electrical source whenever possible. It conserves battery power and also provides automatic charging to keep them in top condition.

**Important:** Always make sure the 110-volt power cord is securely plugged into the outlet. A loose connection could break the circuit and cause battery to drain.

*white - ground*  
*blue - hot*  
*green - tail and clearance lights*  
*black - battery charging by tow car*  
*red - left turn signal and brake light*  
*brown - right turn signal and brake light*  
*yellow - back up lights*



## Trouble-Shooting

Take the time to study your Avion's electrical system, and you will discover that many minor difficulties can be corrected by referring to the following trouble-shooting guide. Major electrical repairs should be handled by an Avion Service Center.

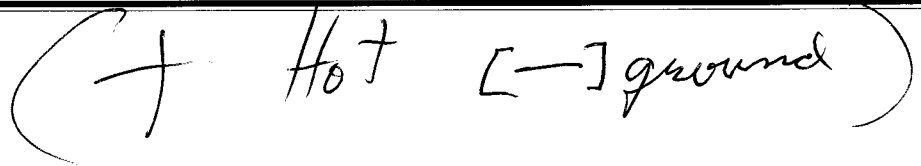

Symptom	Cause	Remedy
No 12-volt power to lights and appliances when operating on 12-volt only.	Input line and/or trailer batteries disconnected.	Reconnect input line and trailer batteries.
	Trailer batteries discharged.	Charge batteries using 110-volt power or tow car alternator.
	Trailer batteries on wrong polarity.	Reverse the polarity. Should be: (+) on hot, (-) on ground.
	Blown fuse.	Replace blown fuse.
Blown fuses or tripped circuit breaker.	Overloaded circuit (over 20 amps).	Turn off lights, appliances and other switches to reduce load. Replace blown fuse at Electrical Control Center or reset breaker.
	Electrical short.	Check Electrical Control Center for blown fuse and replace it or reset breaker. If fuse blows again or breaker trips again, see dealer to have short corrected.
Dim lights and/or sluggish fan motors.	Not operating on 60-cycle power.	Locate 60-cycle power source and hook up to it.
	Trailer batteries discharged.	Charge batteries using 110-volt power or tow car alternator.
	Trailer batteries low on water.	Check all cells and refill to correct level with distilled or filtered water.
	Trailer battery terminals not connected properly or are corroded.	Make proper connections or clean terminals and connectors and coat with light layer of grease.
Electrical Control Center will not charge batteries.	Outside 110-volt power not hooked up.	Connect power cord.
	Trailer batteries not connected or polarity reversed.	Connect batteries or reverse the polarity. Should be: (+) on hot, (-) on ground.
	Trailer battery defective.	Replace battery.
	40-amp battery fuse blown.	Replace fuse.

**Electrical System Diagrams**

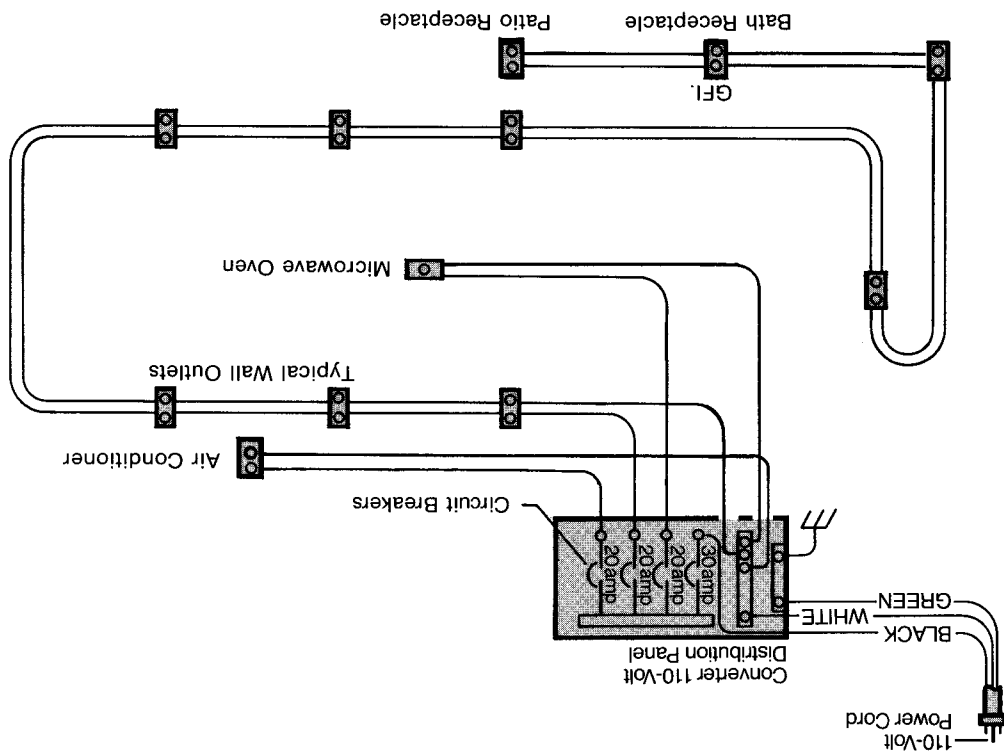

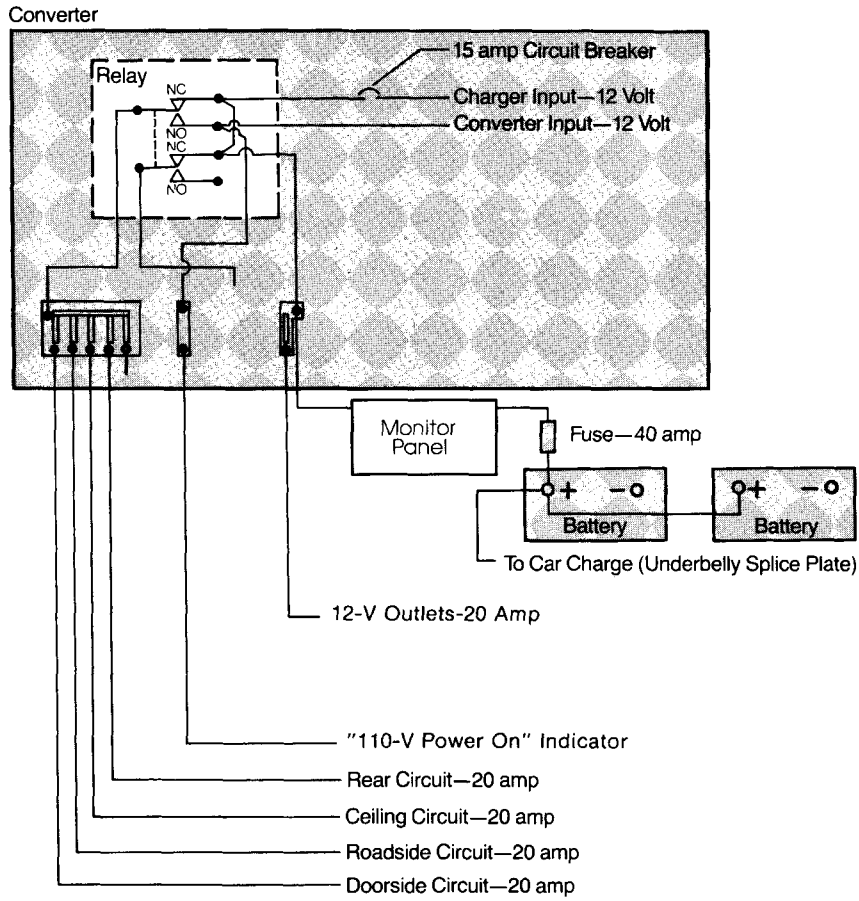

**12 Volt Interior**

**12 Volt Exterior**

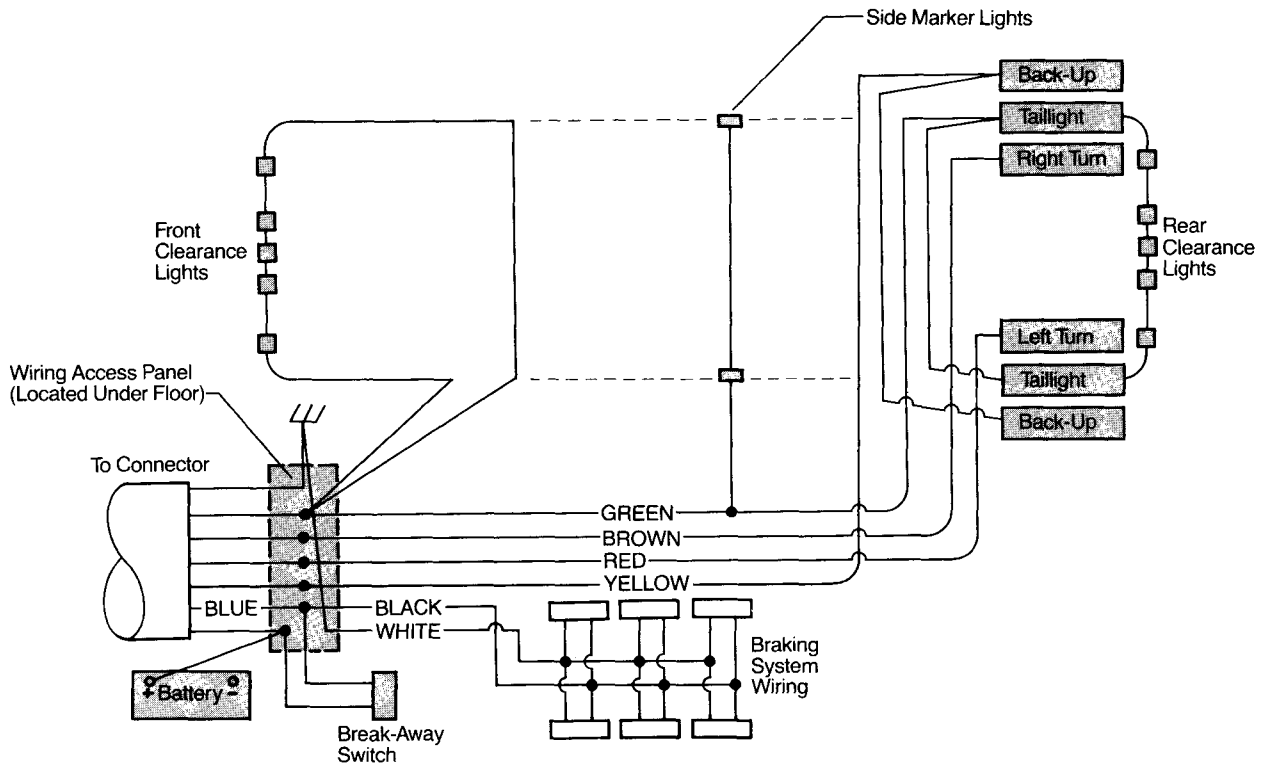

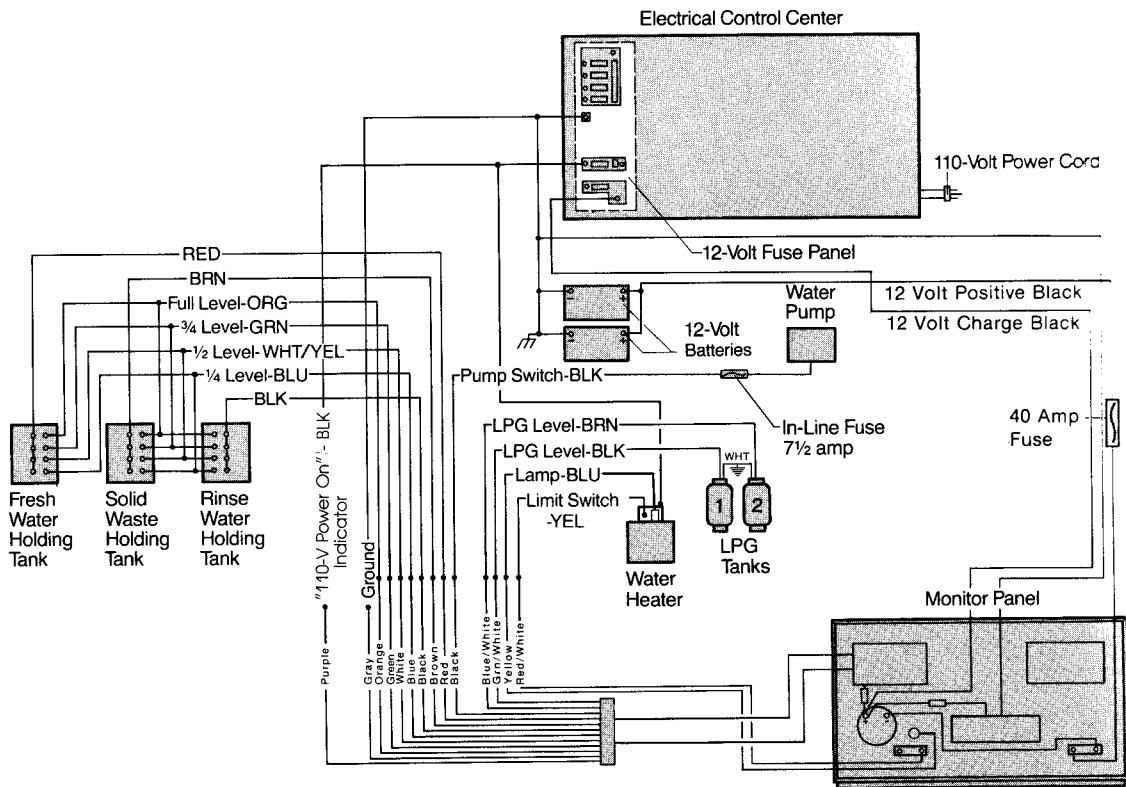

**Monitor Panel**

**Monitor Panel Terminal Strip Color Code**

12VDC Positive	①	12VDC Positive
110V Power On Indicator	②	PURPLE
Water Tank Common RED	③	RED
Solid Holding Tank Common BROWN	④	BROWN
Full ORANGE	⑤	ORANGE
GREEN	⑥	GREEN
WHITE	⑦	WHITE
BLUE	⑧	BLUE
Gray Holding Tank Common BLACK	⑨	BLACK
Water Pump BLACK	⑩	BLACK
LPG 1 BLACK	⑪	GREEN/WHITE
LPG 2 BROWN	⑫	BLUE/WHITE
Water Heater Lamp BLUE	⑬	RED/WHITE
	⑭	Ground

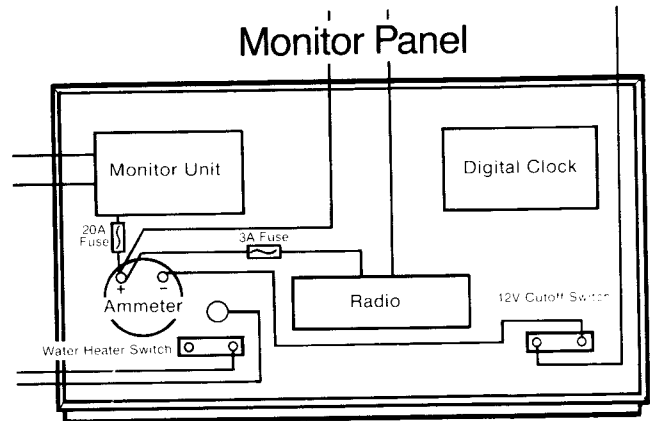

# Appliances

Refrigerator	82
Range and Oven	86
Microwave Oven	90
Furnace	92
Water Heater	95
Air Conditioner	98

# Refrigerator

The Dometic LP gas/electric refrigerator has been engineered for long life and trouble-free service. It has many of the same qualities you expect to find in a model for your home, plus additional features especially convenient for trailering.

## Leveling

To get the most out of your refrigerator, it is essential for it to operate on a level plane when the coach is stationary. Otherwise, the liquid ammonia used in the refrigeration system can collect in pockets around the evaporator coil and impede proper coolant circulation. This can cause the cooling process to stop completely in extreme cases, and may damage the cooling unit.

Check for correct positioning of the refrigerator by placing a small bubble level on the freezer shelf and observing it with the aid of a hand mirror, if necessary. If the refrigerator is not level, realign the trailer to horizontal. See section in **Lengthy Stops**, page 21 for more details.

## Power Sources

The refrigerator can operate on LPG or 110-volt external power. Operating controls for both modes are located inside the refrigerator at the bottom of the food storage compartment.

## LPG Operation

1. Turn the selector knob (A) to the "gas" position (see photo). This opens the LPG valve and automatically renders the electrical circuits inoperative.
2. Rotate the gas thermostat knob (C) to position "4."
3. Pull the knob on the flame failure safety device (D) and press the button of the piezo lighter (E). Repeat pressing of the button until gas is ignited at the burner. Ignition can be observed through the reflector (F).
4. After ignition, hold the flame failure safety knob (D) in the pulled-out position for 15 seconds, then release it and look through the reflector to verify that the burner flame remains lit. If the flame goes out, wait five minutes and repeat steps 3 and 4.
5. Reset thermostat, if necessary, to retain desired freezer and food compartment temperatures.

**Note:** If the gas system has been out of service for a long period, such as for replacement of an LPG bottle, the gas line is likely to become filled with air. If this happens, the lighting procedure must be repeated until the air is purged from the line and gas has reached the burner (see **LPG System**, page 60).

## Electric Operation

1. For 110-volt operation, be sure the flexible power cord is plugged into the 110-volt outlet behind the refrigerator. This can be checked at the refrigerator access compartment outside the coach: Lift cover grille straight up, swing out at bottom, and pull down to remove.
2. With the power selector control (A) turned to the "off" position, push in and rotate the knob clockwise to the desired electric voltage setting. The first "stop" is for 12-volt battery operation. If you are running 110-volt external power, push in the knob again and continue turning it clockwise to that setting.
3. Turn the electric thermostat knob (G) to position "4."

## Using the Refrigerator

### 1. Food storage compartment.

This area of the refrigerator is completely closed and unventilated, in order to maintain the low temperature required for proper food storage. Consequently, foods having a strong odor, or foods liable to absorb odors, should be placed in sealed containers. Vegetables, salads and the like should be covered to retain their crispness. The **coldest** positions inside the refrigerator are underneath the cooling evaporator and at the bottom of the unit, and the **least cold** positions are on the upper door shelves.

2. **Ice Making.** Fill ice cube trays to within  $\frac{1}{4}$ -inch of the top and place them in the freezer section. The ice cubes are released from their trays by pulling upward on the handle. Keep unused cubes in the tray and return it to the freezer compartment. When refilling trays, always wipe the outside surfaces to prevent accumulation of water droplets, which will freeze and cause the trays to stick to the freezer shelf. If the refrigerator is shut down for traveling, empty the trays to prevent spillage when the ice thaws.

Ice making can be accelerated by setting the thermostat to "max." Do this a few hours before the ice will be needed, but always turn back the thermostat to its former setting once the ice is formed, or the foodstuffs in the storage compartment may freeze solid.

3. **Cleaning.** Remove all food to avoid possible contamination from cleaning agents. The interior lining of the refrigerator can be washed with a weak, lukewarm soda solution. All other parts must be cleaned with warm water and a mild soap or detergent **only**. **Never use strong chemicals or scouring powders; they can damage the protective surfaces.** Wipe all surfaces dry with a clean, absorbent cloth.
4. **Defrosting.** The Dometic refrigerator in your Avion is equipped with automatic defrosting in the main food compartment. It has been engineered to eliminate thawing or warming of foods stored either in the freezer or main compartment. When the freezer compartment becomes covered with frost, shut down the refrigerator until the frost has melted. Dry the compartment, wash ice cube trays and refill with fresh water before restarting the unit.

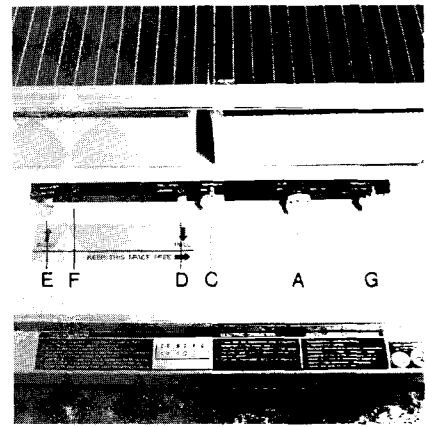

Refrigerator Controls

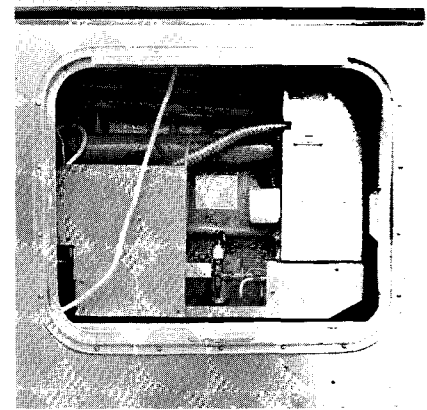

Refrigerator Outside Access Compartment

---

5. **Shut Down.** To turn off the refrigerator temporarily, set the thermostat to "zero" and rotate the power selector knob (A) to "off" position. If the unit is to be out of operation between trips, empty and clean the food compartment and freezer as previously described. Ice cube trays should be emptied, wiped dry and stored in one of the galley storage cabinets. Leave the refrigerator doors slightly ajar, or place containers of activated charcoal inside to prevent the formation of mildew and odors.

### **Periodic Maintenance**

The refrigerator burner assembly will require cleaning and adjustment once or twice a year, depending on usage.

1. Unplug electrical power cords at the refrigerator terminals and turn off the gas flow control valves at the LPG bottles.
2. Disconnect the gas pipe from the burner assembly.
3. Remove the burner bracket.
4. Remove the burner housing.
5. Clean the jet with alcohol and compressed air **only**. Never use a pin; this could widen the orifice, requiring a replacement jet.
6. Clean the burner tube and the gauze with a brush, then blow out with compressed air.
7. Reassemble the burner.
8. Relight the burner and check it with full flame.

At the time you are servicing the burner assembly, you can also check the flue baffle to see that it is clean and reasonably free of soot. If cleaning is necessary, use a good flue brush. Cover burner when cleaning flue to prevent soot from falling down inside burner.

The refrigerator has been designed to run with a minimum of service, but in the event a problem should arise while you are traveling, you will want to know how to locate and correct it, in order to keep the unit functioning until it can be checked by a qualified, factory-trained technician. Remedies for the most common minor malfunctions are presented here.



## Trouble-Shooting

Symptom	Cause	Remedy
Refrigerator does not freeze satisfactorily.	Jet orifice clogged.	Disengage gas pipe from burner. Unscrew nipple with jet, blow clear, and wash in alcohol. Do not use wire or pin to clean orifice.
	Refrigerator not level.	Level the trailer.
	Flame has gone out.	1. Gas supply exhausted; refill. 2. Feeler point of flame safety device not heated enough. 3. Clogged bypass screw: clean or replace it.
	Air circulation around cooling unit restricted.	See that refrigerator is properly ventilated.
	Evaporator heavily coated with frost.	Defrost refrigerator.
	Flue baffle not inserted into central tube of cooling unit.	Insert flue baffle.
	Thermostat incorrectly used.	See section on thermostat. In hot weather, setting should be one or two numbers colder than usual.
	Gauze in burner head clogged.	Clean burner head.
	Burner damaged.	Replace burner.
	Burner positioned incorrectly.	Reposition burner.
	Wrong gas pressure at burner.	Check pressure at burner and at LPG bottles. Burner pressure must not fall below 11" W.G. when thermostat is on "max."
	Thermostat operating improperly.	Check position of capillary tube between evaporator fins. End of tube must be in proper direct contact with evaporator either of these ways: (1) Capillary tube is inserted in spring-clip, which is fastened between two fins; (2) Capillary tube fastened between two fins with sheet brace and two screws. Adjust position of capillary tube end. If no improvement, replace thermostat.
	Odor from fumes.	Flame touches side of burner.
Burner damaged.		Replace burner.
Flame touches flue baffle.		1. Burner damaged; replace it. 2. Flue baffle too low; reposition it.
Flue tube is dirty.		Cover burner and jet, remove flue top and baffle, clean flue with special flue brush, clean baffle.
Burner flame keeps going out.	Burner and bypass screw require service.	Clean or replace burner jet. It must conform to type of gas used (different sizes required for propane and butane). Bypass screw is accessible at top of thermostat.
	Windy conditions.	1. Move coach so that wall with refrigerator vent outlets does not face into wind, causing flame blow-out. 2. If trouble persists, <b>temporarily</b> set thermostat to "max" while coach is either stationary or traveling. Do not leave at "max" for more than one day, or food will freeze.

# Range and Oven

Your Avion is equipped with a Magic Chef® LP gas range and oven, Model BT22JS-4TVX, for cooking ease and dependability. The unit has been especially designed for recreational vehicles, and features such home-like conveniences as four large top burners, an oven big enough to cook a 17-pound roast, and automatic-lighting burners. This fine appliance will give years of excellent service when operated according to instructions.

## Lighting the Pilots

If the unit has not been operated for an extended period it may take longer than usual for pilot ignition, due to air in the gas lines.

1. Make sure all top burner control knobs are in the OFF position, to avoid venting any potentially dangerous gas into the trailer.
2. Set oven control knob on PILOTS OFF position.
3. Turn on main gas supply to the range.
4. Depress oven control knob and rotate it to the OFF position.
5. Lift the hinged main top panel and light the top burner pilot with a match.
6. Open oven door and light oven pilot in the same manner.
7. **Always observe caution. Take steps to insure that gas will not flow into the coach whenever you are making any adjustments or performing maintenance functions. Be certain all valves are in the OFF position, and do not use the pilot adjustment valve as a pilot shut off.**

## Pilot Light Adjustments

Range top burners should light within four seconds. If ignition is difficult, intermittent or uncertain, check the height of the pilot flame and make sure the lighter ports and flash tubes are unobstructed. The tip of the pilot flame should be about 1/8-inch above the lighter cup cone (see illustration). The **range top** pilot adjustment screw can be reached by removing the oven control knob.

The **oven** pilot flame has been pre-set at the factory and is not adjustable.

## Using the Range Top Burners

**Your Magic Chef is equipped and adjusted for use with LP gas only.** The burners have pre-set air openings, and adjustments are unnecessary to assure a proper, blue flame.

To light the burner, simply push in the control knob and turn it **counterclockwise** as far as it will go to insure ignition, then turn it back in the other direction (clockwise) until the desired flame height is reached.

If the flame burns with an impure orange color, or the blue is tinged with green, it is probably due to metal filings left in the burner during manufacture or excess dust in the air. Clean the burners if condition persists for more than a few minutes. For more information about flame adjustment, refer to the Magic Chef manual provided with each unit.

**Caution: Never close the top cover when the range is in operation; this could extinguish the flame and allow gas to escape into the trailer.**

## Using the Oven

The oven is controlled by a low-temperature thermostat. It has no bypass setting and will automatically cycle on and off at all temperature settings except "broil" ("BR") to maintain constant, even oven heat.

To light the oven after activating the pilot, depress the oven control knob and turn **counterclockwise** to the desired temperature setting. The oven is equipped with a safety ignition system that requires approximately 45 seconds delay before the main burner ignites. This is normal, and there is no gas escaping during the delay.

A properly-functioning oven burner will have a blue flame that is about three inches long and sitting on the burner. If the flame is a different length, or if it is dancing on or above the burner, the air shutter is out of adjustment. Correct the situation by fully opening the shutter to produce a blowing condition, then close it slowly until the blowing stops. At this point, the air shutter is correctly set.

Always turn the oven control knob to OFF when the oven is not in use. The pilots will remain lit and ready for use when in this position. When you travel, turn the oven control knob to PILOTS OFF and follow the complete procedure for lighting the pilots during your next stop. **Never travel with the pilot lights functioning; they might be extinguished and cause gas to enter the coach.**

### Range and Oven Shut Down

To shut down the unit for traveling, cleaning, or extended periods of nonoperation, move the oven control knob to the PILOTS OFF setting, and turn off the main gas supply.

### Cleaning

You can keep your range and oven looking bright and new by wiping all surfaces with each use. Wait until it cools down, then use a warm detergent solution and a soft cloth or sponge. The range top is hinged for easy raising or removal when cleaning around the burners. The burner heads themselves should also be cleaned, but always make certain that all air and gas ports are unclogged when you are finished. Use a toothpick or similar device to clear the ports.

The variety of materials and finishes on your range require special care. Follow these tips for best results.

1. **Porcelain Enamel.** Spilled foods with high acid content should be wiped up immediately to avoid damaging the finish. **Do not use harsh abrasive cleaners or steel wool.**



Range and Oven

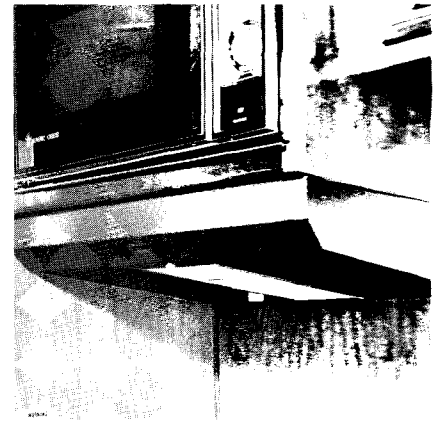

Range Exhaust Hood and Light

### Range Top Pilot Adjustment

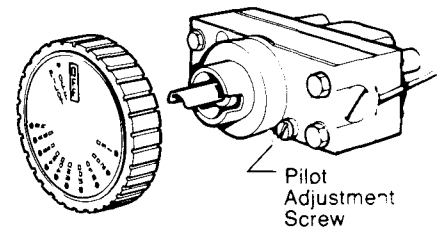
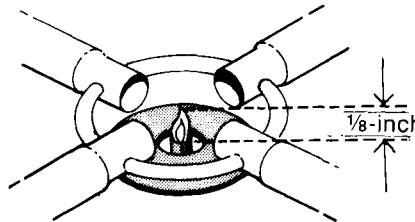

2. **Chrome.** Wipe with damp cloth, then dry. Use chrome polish to remove stubborn stains.
3. **Glass.** Wait until surface cools, then wipe with detergent and hot water. Rinse and polish with soft cloth.
4. **Aluminum.** Use a steel wool soap pad to remove stains and restore luster. **Do not use caustic solutions.**
5. **Broiler Pan and Insert.** Sprinkle with liquid or powdered detergent and cover with damp cloth or wet paper towels as soon as possible after using, to help loosen drippings.
6. **Oven Interior.** Wipe clean with damp cloth. If oven bottom is removed for cleaning, lock it in place when reinstalling.

**Caution:** If you use a commercial oven cleaner, protect the aluminum gas tubing, thermostat sensing bulb, and electrical components by covering with masking tape or similar material. Rinse oven thoroughly with a solution of one tablespoon vinegar to one cup water.

## **Tips for Safe Operation**

1. **Never light matches inside the coach or in the vicinity if gas odor is present.**
2. Always open an air vent or window slightly while using the range. Gas flames consume oxygen, which must be replenished for proper combustion.
3. **Do not tamper with burner orifices.**
4. Do not leave top burners lit without cooking utensils on them. Overheating may damage porcelain finish of the grates.
5. **Do not leave the top cover of your range in a down position if the top burners are on.**
6. **Never use your gas range as a space heater.**
7. **Clean up oven spillovers immediately. Any accumulation may cause smoking or ignition.**
8. Use aluminum foil properly, otherwise it could adversely affect oven performance. If foil is used to catch drippings, allow at least two inches around it on all four sides of the oven bottom. **Never cover air holes in the oven bottom.**
9. **Do not store utensils in the broiler area. They could damage or dislocate the oven burner and pilot.**
10. **Never leave burners or pilot lights on while traveling or while refueling at a gasoline service station.**

The following guide covers some of the most common problems you might encounter, and how to handle them without the need for outside service. For additional information, refer to your Magic Chef manual.

## **Range Exhaust Vent**

The range exhaust vent draws in cooking fumes, odors, heat and smoke from the galley and discharges them outside the trailer. To operate the exhaust fan, push the on-off button on the vent.

The exhaust filter should be cleaned at least twice a year. To remove it, unscrew retainer nuts from the on-off buttons that run vent fan and light, and let the cover plate drop down. Wash the filter in a detergent solution, then rinse thoroughly and dry before reinstalling.

Access to the range vent bulb compartment is also gained by removing the push button retainer nuts. See page 108 for replacement lamp size.

## Trouble-Shooting

Symptom	Cause	Remedy
1. Slow-heating oven. 2. Poor baking. 3. Poor ignition of burners. 4. Pilots will not stay lit. 5. Popping sound from top burners. 6. Carbon on pilot shield. 7. Burner flame too low or high.	Defective gas pressure regulator.	Have gas pressure regulator tested by dealer and replace if necessary.
Oven pilots will not light or stay lit.	Incorrect pilot adjustment for type thermostat being used.	Adjust pilots.
	Pilot tubing is kinked, clogged or leaking at fittings.	Check pilot tubing and make necessary corrections.
	Defective gas pressure regulator.	Have gas pressure regulator tested by dealer and replace if necessary.
	Thermostat dial set in "pilot off" position.	Move thermostat to "off" position and light pilot.
Top burner pilot will not light or stay lit.	Pilot flame too high or low.	Adjust pilot flame.
	Pilot cup assembly not level.	Turn pilot filter clockwise or counter-clockwise with wrench until cup assembly is level.
	Defective gas pressure regulator.	Have gas pressure regulator tested by dealer and replace if necessary.
Top burners will not light.	Burners and/or flash tube not positioned correctly.	Reposition burners and/or flash tube.
	Pilot light out.	Relight pilot.
	Air shutter not adjusted properly.	Adjust air shutter.
	Burner parts clogged.	Clean burner parts with toothpick.
	Loose igniter port.	Tighten igniter port by pressing in or replace.
1. Oven burner will not light. 2. Excessive heat burns food. 3. Pilot outage.	Constant pilot light is out.	Relight pilot.
	Pilot assembly out of position.	Reposition pilot assembly.
Gas odor.	Possible gas leak.	Check all connections with soapy water (do not use chlorine or ammonia), and make necessary repairs. <b>Shut down LPG system until symptom has been corrected.</b>
Cakes rise higher on one side.	Pans set too close to side of oven.	Position pans at least two inches from sides of oven.
	Range not level.	Level the range.
Oven door not closing properly at left or right corner.	Normal expansion and contraction of metal parts.	Adjust door as follows: (1) Open oven door and slightly loosen four sheet metal screws holding door panel to liner; (2) Close door with a potholder inserted at opposite lower corner of door. While holding door in at bottom corner where potholder is located, press top of door at opposite corner in toward the over; (3) Open door and tighten screws.

# Microwave Oven

The built in Magic Chef® microwave oven, Model MW207-4 adds the newest dimension in modern cookery to your Avion. The unit plugs into 110-volt outside electrical power via a receptical located inside the back of the oven cabinet.

## Using the Oven

1. Open oven door and place food inside. The interior light comes on automatically when door is opened and remains on during the cooking cycle.
2. Turn the solid-state heat control to the desired setting. The cookbook included with your oven gives recommended settings to use when cooking or defrosting. The "low" setting is approximately 10% of full heat, with each number on the control dial representing a corresponding percentage of full power ("3" indicates 30%, "5" is 50%, etc.).
3. Set the timer by turning counter-clockwise to the appropriate position. For cooking times less than one minute, move the dial counter-clockwise past "1" and then clockwise to the number of seconds desired (each mark represents 15 seconds).
4. Close the door to start the cooking sequence. The blower and heating indicator light will come on, and the timer will gradually return to "off" as cooking time elapses.

**Note: The oven light may flicker at heat settings less than "high," and you will hear the sound of the oven controlling the cooking. This is normal operation at settings below full power.**

5. When cooking has been completed, a bell sounds and the oven, blower, heating indicator light and interior light shut off automatically, to assure that microwave energy is no longer being produced.
6. If the door is opened during operation, the interior light will remain on but all microwave energy stops instantly. The blower, heating indicator light and timer also stop automatically and will restart only when the door is closed again.
7. The oven may emit smoke during operation if the browning dish is used. This is caused by spattering on the special cooking surface of the dish and is normal.
8. Some food containers may get hot during cooking, either from the food inside them or from microwave absorption by the container. See your cookbook for complete information.
9. Some foods may not cook as rapidly as the cookbook indicates, due to variations in the size, shape and weight of the items. Cookbook times and settings are intended as guidelines to help prevent overcooking, which is the most common problem in becoming familiar with a microwave oven. Use your own judgment along with the cookbook suggestions and check the food occasionally while it is cooking, just as you do with a conventional oven.
10. Be sure the timer is in "off" position whenever there is no food in the oven.

**Caution: Corn should not be popped in your microwave oven due to the possibility of fire. Also, as with conventional cooking, excessive overcooking of food in a microwave may cause it to ignite.**

## Care and Cleaning

Clean your microwave oven with a mild, non-abrasive detergent and warm water. Use a soft cloth to apply the solution to all exposed exterior and interior surfaces, including door, shelf, and side, top and back walls. Rinse well and wipe dry. The rubber door seals should be cleaned in the same manner and kept free of grease and food spatters to insure proper closure. Wipe spills from the shelf with a damp cloth every time you clean the oven.

Accumulated material will dry and become more difficult to remove.

**Never use scouring pads, powdered cleansers or other abrasive products to clean the oven.**

To replace the interior light bulb remove oven from cabinet, disconnect trailer from 110-volt power source, loosen the screw on the rear access panel and open it. Replace bulb with a similar 25-watt bayonet-type. Close rear access panel and tighten screw.

## Precautions Regarding Microwave Energy

Always observe the following precautions to avoid possible exposure to excessive microwave energy from your oven.

1. Do not attempt to operate oven with the door open, since this can result in harmful exposure to microwave energy. Safety interlocks have been built into the unit to prevent open-door operation, and it is important not to defeat or tamper with them.
2. Do not place any object between the oven front face and the door, or allow food, grease or cleaner residue to accumulate on sealing surfaces.
3. Do not operate the oven if it is damaged. It is especially important for the oven door to close and seal properly. This may not be possible if the door is bent, if hinges and latches are broken or loose, or if door seals and sealing surfaces are dirty or damaged.
4. Do not attempt to adjust or repair the oven yourself. This should be done only by properly qualified service personnel.

## Registration

The federal government requires filing of records on the location of all microwave ovens. A registration card has been included with your oven for this purpose. It should be completed and mailed to the manufacturer upon delivery of your Avion travel trailer. In the event you move, the manufacturer should be notified of your new address in order to keep the registration current.

## Trouble-Shooting

If operating instructions have been followed and the cooking cycle does not begin, take one or more of the following steps.

1. Make sure the oven door is closed and latched tightly.
2. Check to see that the 110-volt power cord is connected to the receptacle inside the oven cabinet.
3. Check 110-volt circuit breakers at the Electrical Control Center.
4. Move timer to the "off" position and try resetting.

If oven cooks too slowly check source of wiring to trailer. Voltage loss due to inadequate wiring could cause reduced cooking power (slow performance).

**Caution: If the unit continues to malfunction after these steps have been taken, have it checked by an authorized technician. Do not attempt any repairs yourself.**

---

# Furnace

Your Avion coach is equipped with a Duotherm gas furnace specifically engineered for trailer use. The forced air, direct vent system unit is certified by the American and Canadian Gas Associations for safety and performance when used with LPG fuel.

## Features

The furnace has a number of features that make heating precise and convenient. Dual blowers provide efficient heating and maximum air distribution. The **combustion air blower** draws air from outside the trailer and into the combustion chamber, then out through the exhaust tube. The **circulating room air blower** recycles interior air by pulling it through the intake grille, then forcing it across the heat chamber and out the heat registers. The blower chambers are sealed to prevent mixture of combustion air and circulating air.

Heated air is also delivered to and around the fresh water holding tank by a duct network, to aid in preventing freezing during cold weather operation.

Duotherm's solid state electronic ignition system eliminates the pilot light and manual ignition of the furnace.

The furnace is turned on and off automatically by a wall thermostat. Simply set it to the desired temperature and forget it.

## Operation

When the thermostat calls for heat, the blower motor is immediately energized. One motor is used to drive both the combustion air and the circulating air blower wheels. Although one motor drives both wheels, the blowers are separate. The combustion air blower is sealed so as to allow no passage of air between it and the circulating room air blower. The combustion air blower draws air from the outside atmosphere, discharges it into the combustion chamber, and forces the combustion products out the exhaust tube. The circulating room air blower pulls return air in and forces it across the heat chamber, discharging it to the area to be heated.

As the blower motor reaches approximately 75 per cent of its full speed, the combustion switch will engage allowing current flow to the gas valve and the automatic ignition device. After the thermostat is satisfied, the gas valve will close, and the flame on the main burner will go out. The blower will continue to run for a short period and will then shut off.

Follow these steps to start the furnace operation:  
**IMPORTANT: FAILURE TO FOLLOW THESE LIGHTING INSTRUCTIONS EXACTLY MAY RESULT IN DAMAGE TO THE UNIT.**



1. Set the thermostat to "OFF" position. Remove furnace front panel.
2. Turn gas valve to "OFF" position. Wait 5 minutes.
3. Turn gas valve to "ON" position. Set thermostat to "ON" position and adjust to desired setting.
4. Allow 5 to 8 seconds for burners to ignite.
5. If burners do not light, set thermostat on "OFF" position, wait 5 seconds, then re-set thermostat to "ON" position.
6. Replace furnace front panel.
7. If ignition is not successful after three attempts, turn gas valve knob to "OFF", set thermostat to "OFF", and refer to TROUBLESHOOTING, page 94.

### **Helpful Hints**

1. Excess humidity can be removed from inside the coach while the furnace is on by creating cross ventilation. The recommended method is to slightly open a roof vent and one window.
2. Do not block the flow of air through the furnace exhaust/air intake grille or through the heat registers. **Blocking any air duct will severely hamper furnace efficiency.**

**Caution: Never cover the flue exhaust gas vent, located on the outside wall of the coach. Obstruction of this vent can cause dangerous exhaust gases to remain inside the trailer. Check the exterior exhaust vent often to insure against clogging. Do not touch the vent during or immediately after the furnace has been running, since it becomes very hot during operation.**

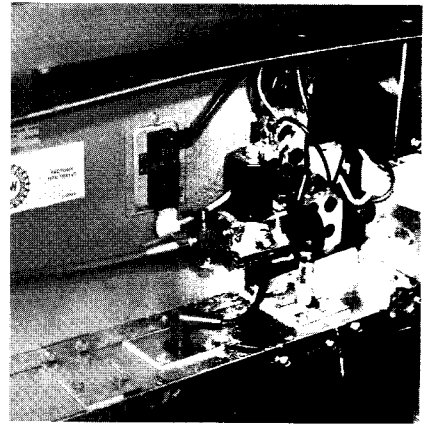

*Furnace Gas Valve*

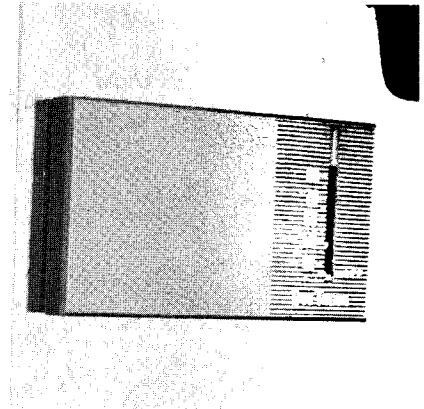

*Furnace Thermostat*

## Maintenance

The Dyna-Trail furnace is equipped with a sealed motor that is lubricated for life. The furnace itself does not require any routine maintenance or cleaning, if properly adjusted. However, carbon deposits may form on the inside of the combustion chamber if the main burner has been operated with a high yellow flame (indicative of restricted air flow).

Heavy carbon deposits require cleaning, using the access hole on the front of each radiation chamber. Use a vacuum cleaner for best results.

**Caution: Always shut down the furnace before attempting any service or maintenance.** This is accomplished by turning off the manual gas valve located at the furnace and setting the wall thermostat to the "off" position.

You can expect many years of trouble-free service from your Dyna-Trail furnace in normal use, if you follow the manufacturer's operating and maintenance instructions. Should a problem arise, however, you will probably be able to correct it yourself by using the following guide. See manufacturers literature for additional trouble-shooting suggestions. If the difficulty persists, consult a Dyna-Trail authorized service center.

## Trouble-Shooting

Symptom	Cause	Remedy
Furnace does not generate heat.	Thermostat set improperly or malfunctioning.	1. Reset if too low or in "off" position. 2. Reconnect thermostat wire to terminal if loose. 3. Replace relay if "click" is heard when setting is raised but blower motor does not start.
	Gas valve closed.	1. Open valve.
	Electrical malfunction.	1. Recharge batteries if blower fan runs below full speed. 2. Tighten connections at battery terminals.
Furnace does not operate.	Faulty wiring.	1. Tighten all connections. 2. Correct short circuits. 3. Check for proper wiring connections to AC/DC power converter.

# Water Heater

Standard equipment includes a six-gallon capacity Atwood Vacuum Machine Company gas water heater, Model G6A2E, the finest unit available for recreational vehicle use. It incorporates a number of exceptional features for safety and ease of operation.

Electronic ignition completely eliminates the pilot light and therefore the problems of pilot outage, bad weather lighting, and shut down. One switch at the Monitor Panel ignites the water heater and operates it automatically until you turn it off.

Atwood's unique triple-gap construction insulates side walls from hot flue gases, keeping the water hot but not the coach interior. In addition, the through-tube sealed combustion chamber vents both air intake and exhaust gases through a single opening. This design not only eliminates the possibility of fumes entering the trailer, it also provides one of the most efficient heat transfer systems available.

A 125-psi capacity temperature relief valve in the water heater prevents the release of excessive water pressure through the faucets when they are turned on. Instead, as the rising temperature inside the closed system causes pressure to increase as the heated water expands, the pressure will automatically be released through the exterior relief valve when it reaches the 125-psi limit.

## Operation

The water heater is located on the road side of the coach, near the back end. A compartment is provided for access to the gas controls and drain valve. To open the louvered panel, pull the spring-loaded lever at top, rotate until it is lined up with the slot on the panel, then release. The door is hinged at the bottom and swings down. It may be padlocked for security, if desired.

Activation of the water heater requires only two simple steps.

1. Check to be sure there is water in the water heater tank.
2. Press the Water Heater switch on the Monitor Panel to "on". This activates the pilotless ignition and lights the burner.

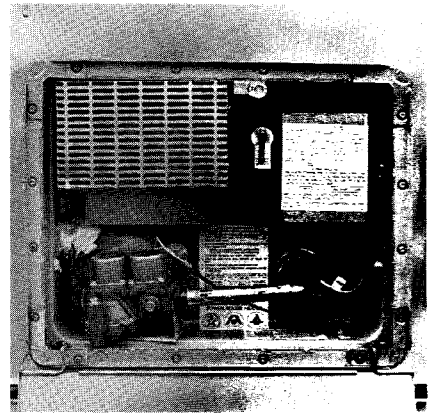

Water Heater Outside Access Compartment

To shut down the water heater, merely press the ignition switch to "off."

## Maintenance

The Atwood water heater is virtually maintenance-free. All that is necessary is to drain it if the trailer will be out of service during winter months. The drain valve is located in the exterior access compartment, at the front of the water heater. Refer to **Winter Storage** section, page 102, for more information on water system draining.

Under some conditions the Monitor Panel "Water Heater" light may not flash when the heater is turned on. Please refer to "TROUBLE-SHOOTING", page 96. Access to the ECO reset button mentioned in the troubleshooting chart is by removing the bathroom wardrobe shelf, or through the small access panel beside the stool in the bath wardrobe face. The ECO reset button is on the back of the water heater.

## Trouble-Shooting

Symptom	Cause	Remedy
Monitor Panel light does not flash when switch is turned on.	Water in tank has reached 160°.	Drain off water until it falls below 160° then observe unit for start up.
	Battery producing less than 10 volts.	Recharge battery.
	ECO switch has cut off.	Remove cover from back of water heater and depress red reset button.
	Incorrect or faulty wiring.	Check wiring using schematic diagram in water heater service manual.
	Defective Monitor Panel switch.	Replace switch.
	Defective ECO switch.	Check for closed contacts with continuity tester. Replace switch if faulty.
Monitor Panel light remains on (not a flash) when switch is turned on.	Defective thermostat.	Replace if contacts are not closed when thermostat is cooled.
	Battery producing less than 10 volts.	Recharge battery.
	Improper wiring.	Check schematic diagram in water heater service manual.
	Circuit board ground wire or ground at back of unit broken or disconnected.	Repair or reconnect ground.
	Flame sensing probe is grounding to flame spreader or burner.	Check by removing lead from probe. If unit goes through lock-out cycle, bend sensing probe away from flame spreader and replace lead.
Monitor Panel light flashes, then stays on when switch is turned on.	Top of SCR is contacting sheet metal casing with power off.	Bend SCR top until it does not touch sheet metal.
	No gas supply.	Make sure all gas valves are open. Unit must have minimum 11 inches water column pressure.
	Faulty connection to solenoid valve.	Check connection with volt meter (should read 12 volts).
	Defective solenoid valve.	Check with one lead on case, one lead on white wire. An audible click should be heard. If not, replace solenoid valve.
	Water temperature at 160°, causing contacts to fluctuate.	Drain off water until temperature drops below 160°.
	Defective circuit board.	Replace circuit board.
Monitor Panel light flashes one time, then goes out when switch is turned on. Heater ignition does not take place.	Spark probe grounded.	Correct gap. Should be 1/8-inch from center wire and/or burner tube, with flame spread up.
	Broken or shorted spark probe wire.	Repair or replace the heavy insulated, light brown wire.
	Water temperature at 160°, allowing contacts to fluctuate.	Drain off water until below 160°.
	Defective circuit board.	Replace circuit board.

<b>Symptom</b>	<b>Cause</b>	<b>Remedy</b>
Yellow main burner flame.	Improper air adjustment.	Correct the air adjustment.
	Main burner orifice partially clogged.	Remove and clean. Do not enlarge
	Main burner tube obstructed.	Remove and clean.
	Flame spreader bent or missing.	Straighten or replace flame spreader
	Inadequate gas pressure into valve.	Check with monometer for minimum 11-inch water column pressure.
	Inadequate gas pressure at outlet side of valve.	Remove pressure tap plug from right front of solenoid valve. Insert 1/8-inch NPT pipe nipple. Hook up monometer and turn on unit.
	Obstruction in upper left side of grille.	Make sure grille is not covered by tape, filters, etc.
	Gas solenoid bracket not aligned.	Align bracket so that orifice is pointed up the center of main burner.
Relief valve drips or weeps.	Pressure build-up due to cold water being heated.	Normal condition. No action necessary.
	Foreign material on valve seat.	Flip valve handle several times to dislodge material.
	Valve popped open by steam formed in partially-filled tank.	Purge air from water system by turning on a sink faucet.
	Faulty valve.	Replace relief valve if weeping is persistent.
Tank leaks water.	Defective fitting.	Check all plumbing fittings for leaks and repair them.
	Corroded tank.	Refer to water heater warranty for tank replacement.

---

# Air Conditioner

The optional Duo-Therm® air conditioner is roof-mounted and may be used for cooling, heating or recirculating air throughout the coach. Its 13,500 BTU cooling capacity assures maximum comfort at all times.

## Operation

All functions are controlled by three knobs located on the interior air box cover in the ceiling. These controls operate the blower, thermostat and air flow (see photo). Models with optional heating do not have an air flow control.

1. **Cooling.** Set thermostat to desired temperature setting. Turn blower fan switch to high, medium or low cool position. **The air conditioner will not operate until this speed selection has been made.** Adjust the air flow knob and air box louvers for desired air circulation pattern. To shut off the unit, simply turn the blower switch to "off."
2. **Heating.** Set thermostat to the desired setting. Turn blower fan switch to high, medium or low heat. **The unit will not operate in its**

**heating mode until blower speed selection has been made.** Adjust louvers for desired distribution. Shut off the unit by turning blower switch to the "off" position. This feature is not intended for heating the trailer but rather to take the chill off.

3. **Air Circulation.** Air can be recirculated through the trailer without cooling or heating by setting the blower control to high, medium or low fan. Set air flow knob and side louvers for desired air flow pattern. Turn off the unit by moving fan switch to "off" setting.

For maximum operating performance and economy, always close windows, vents and the main door before using the air conditioner. **Make sure the gas furnace thermostat is set at "off."**

The air conditioner is equipped with a delayed start feature, which operates only when the blower switch is set for **cooling**. The compressor will not start until approximately two minutes after the blower is turned on, and it will not restart for about two minutes after the blower has been turned off and then on again. This automatic feature protects the compressor from possible overload.

## Maintenance

Although the Duo-Therm air conditioner requires little maintenance, the air filter should be cleaned or replaced periodically to keep the unit running at peak efficiency. To remove filter, turn the two screws on side of air box with a screwdriver or coin. The louvered cover will drop down, permitting access to the filter. Wash filter in warm sudsy water, then rinse it and dry between two paper towels before reinstalling. **Do not operate the air conditioner without an air filter.** Replacements are available from Duo-Therm dealers and distributors.

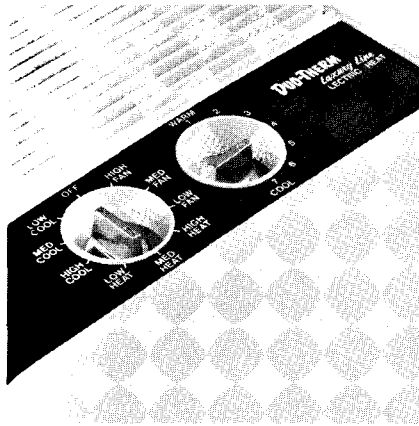

Air Conditioner Controls

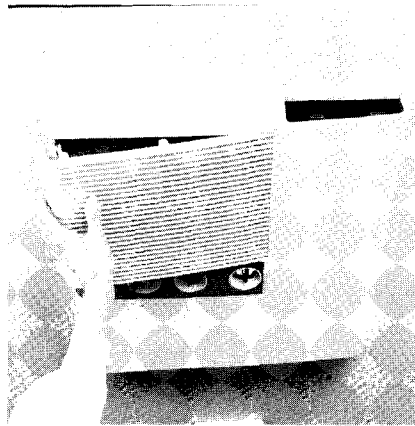

Air Conditioner Filters

### Trouble-Shooting

Symptom	Cause	Remedy
Unit will not run.	Power cord not making good connection.	Check connection. Make sure cord weight does not pull plug from receptacle.
	Circuit breaker is in "off" position.	Reset circuit breaker at Electrical Control Center.
Unit does not cool properly.	Dirty air filter.	Clean or replace filter.
	Voltage too low for compressor to operate.	Hook up to power source of at least 110 volts.

# Maintenance

---

Winter Storage 102

---

Full One Year Warranty 104

---

Maintenance Schedule 106

---

Maintenance Record 107

---

Specifications 108

---



# Winter Storage

Your new Avion requires special attention during the winter months in colder climatic regions. In extreme cases, increased pressure caused by the expansion of freezing water can burst plumbing. You can avoid the possibilities of such damage by winterizing the fresh water system, rinse water drainage and solid waste drainage systems, and the trailer batteries. Observe the following procedures.

1. **Level the coach from side-to-side and front-to-rear.**
2. **Turn off water heater at Monitor Panel and gas system at LPG bottles.**
3. **Disconnect the fresh water inlet hose.**
4. **Inspect the drain lines.** Avion's water lines have been engineered to permit draining by gravity, and should be checked to verify that they are intact and have not been bent out of position.
5. **Locate the fresh water holding tank drain valve** on the road side of the coach at the rear, under either a bed or dinette seat or optional side vanity. See water systems diagrams, page 67, for specific locations.
6. **Drain the fresh water holding tank.** Switch on water pump at the Monitor Panel and open the drain valve located at end of fresh water holding tank. Open all sink and shower/tub faucets to **full cold position**. Open the bypass valve. Any fresh water remaining in the lines will now flow into the sinks and bathtub and then drain through the rinse water plumbing into the rinse water holding tank.
7. **Drain the water heater tank.** Turn off water pump at the Monitor Panel rocker switch. Leave sink and shower/tub faucets open to full hot to provide a vent. Open the outside panel of the water heater access compartment, then remove plug and allow tank to drain. Drain valves for both hot and cold water lines are located in the bathroom vanity cabinet. Open these valves to drain water lines. **These drain valves must be closed and the water heater plug replaced before the water system can be used again.**
8. **Drain the toilet.** With the bathroom sink faucet open to full cold, depress both foot pedals at base of toilet. This operation will clear the water line to the toilet and allow the system to drain into the solid waste holding tank. Open the drain valve behind the toilet, and with the sink faucet still on full cold, again hold down both pedals to clear the line. **This drain valve must be closed before using the water system again.**

**Note: Do not attempt to flush a frozen toilet.** If water is inadvertently left in the bowl, the unit should be allowed to thaw at room temperature before flushing.

9. **Drain the water saver spray gun.** Hold the spray head over a receptacle placed on the bathroom floor, depress the valve button, and keep it in the "open" position with tape or a rubber band. Allow the spray hose to drain completely. The spray head should then be removed from its hose and stored to prevent damage from freezing.

10. **Drain the telephone-style shower head and hose.** With the shower/tub faucet open and set midway between hot and cold, move shower head volume control button to "on" position and drain the hose completely. Remove shower head and store it.
11. **Drain the water pump.** Open fresh water tank drain valve, bypass valve, and water system drain valve located adjacent to the water pump (see water system diagrams for exact locations). Turn on water pump and allow it to discharge any remaining water. The water pump should then be switched off, but all valves should be kept open to allow gravity draining of any water that may be left in the lines. **These valves must be closed before using the water system again.**
12. **Drain all remaining water from the lines.** Place chocks in front of and behind all trailer wheels. Crank the post jack until fully extended. This will raise the front end of your Avion high enough to permit most water remaining in the lines to drain. Then retract the jack to its lowest position to complete the draining process. Return coach to its level position.
13. **Drain the traps.** They are located in the galley sink, bathroom sink and bathtub. Use a suction pump to remove any water from these traps, or pour one cup of **ethylene glycol-base antifreeze** into each trap. Avoid spilling the solution on plastic surfaces to prevent discoloration. Do not travel with antifreeze in sink or tub traps unless the drain plugs are inserted securely to preclude splattering.
14. **Drain the rinse water and solid waste holding tanks.** Connect sewer hose from the trailer sewage outlet to a sanitary dump station, open the valves on both holding tanks, and drain completely. Then flush the tanks with clean water.

**Important: Never use an alcohol-base antifreeze.**

15. **Protect the water purification system.** Remove cartridge from the optional water purification system and allow it to dry thoroughly, then store for the winter.
  16. **Remove the batteries.** Your Avion's batteries should be removed and stored in a temperate environment during sub-freezing weather. Battery life can be prolonged by making regular checks of fluid level and maintaining a full charge. This is especially crucial in cold weather, when a full charge can prevent internal freezing.
  17. **Remove easily damaged items.** Foodstuffs, cosmetics, liquids, etc., should not remain in the trailer during winter storage. Such products might suffer freezing damage or could burst their containers and harm the interior of your Avion.
3. Dilute the antifreeze according to manufacturer instructions.
  4. Open all sink and shower/tub water faucets fully, with the setting midway between hot and cold.
  5. Insert the free end of the hose into the antifreeze container until it touches bottom.
  6. Switch on the water pump and run it until the antifreeze solution fills all fresh water lines and the water heater.
  7. Flush the toilet, and run water saver spray gun and shower head until the lines are filled.
  8. Close all faucets and switch off the water pump.
  9. Remove the antifreeze hose from water pump inlet port and reconnect the water pump inlet line.

### **Additional Winter Protection**

If you desire a further measure of protection, add an antifreeze solution to the entire water system. **Use only a non-toxic type approved for drinking water systems**, and proceed as follows:

1. Close all drains and reconnect all lines. Disconnect the water pump inlet hose.
2. Attach a length of antifreeze hose to the water pump inlet port. The hose should be long enough to reach the bottom of the antifreeze container.

*see page 67 for details.*

### **Service Intervals**

We recommend that you visit your authorized Avion dealer after winter storage for a preventative maintenance check-up and cleaning of the LPG-operated appliances. **This insures against potentially dangerous gas leaks.** When preparing your trailer for a new season of use, be sure to flush any antifreeze solution thoroughly and to close all valves before refilling the system with fresh water.

If you use your Avion year-round, see your dealer every six months for preventative maintenance.

# Full One-Year Warranty

For trailers manufactured by subsidiaries of Fleetwood Enterprises, Inc. Sold in the United States and Canada

## Coverage Provided

Your new travel trailer, including the structure, plumbing, heating and electrical systems, and all appliances and equipment installed by the manufacturer, is warranted under normal use to be free from manufacturing defects in material or workmanship.

The warranty extends to the first retail purchaser and his transferee(s) and begins on the date of original retail delivery or the date the travel trailer is first placed into service as a rental, commercial or demonstrator unit (whichever occurs first). The warranty extends for a period of one year from that date.

This warranty covers only those defects which become evident within one year from the date of original retail delivery or the date the travel trailer is placed into service as a rental, commercial or demonstrator unit, and where written notice was given to the selling dealer or the manufacturer not later than one year and ten days after such date.

## Owner's Obligations

The owner is responsible for normal maintenance as described in the Owner's Manual; however, minor adjustments (such as adjustments to the interior or exterior doors, LP regulator pressure, cabinet latches, TV antenna control, etc.) will be performed by the dealer during the first 90 days of warranty coverage. Thereafter, such adjustments are the responsibility of the owner as normal maintenance unless required as a direct result of repair or replacement of a defective part under this warranty.

If a problem occurs which the owner believes is covered by this warranty, the owner shall contact the **selling dealer**, or other authorized dealer, giving him sufficient information to resolve the matter. The owner shall deliver the travel trailer to the

**dealer** or manufacturing plant location for warranty service.

## Dealer's Obligations

By agreement with the manufacturer, the dealer is obligated to maintain the travel trailer prior to retail sale, to perform a detailed pre-delivery inspection and to repair or replace any parts necessary to correct defects in material or workmanship.

## When The Dealer Does Not Resolve The Problem

If the dealer is unable or unwilling to resolve a problem which the owner is convinced is covered by the warranty, he should contact the **manufacturing plant** at the address listed below and provide the manufacturer with a description in writing of the problem and attempts made to resolve it.

## Manufacturing Plant Obligations

Upon receipt of notice of a claim, where the dealer was unable or unwilling to resolve the problem, the manufacturing plant will repair or replace any parts necessary to correct defects in material or workmanship, or will take other appropriate action as may be required.

## When The Manufacturing Plant Does Not Resolve The Problem

If the representatives of the manufacturing plant are unable to resolve the problem and the owner is convinced that it is covered by the warranty, the owner should call the toll-free number listed below to describe the problem and the attempts made to resolve it.

## What Is Not Covered By The Express Warranty

THIS WARRANTY DOES NOT COVER:

1. TIRES AND BATTERIES, WHICH ARE COVERED BY THE SEPARATE WARRANTIES OF THE RESPECTIVE

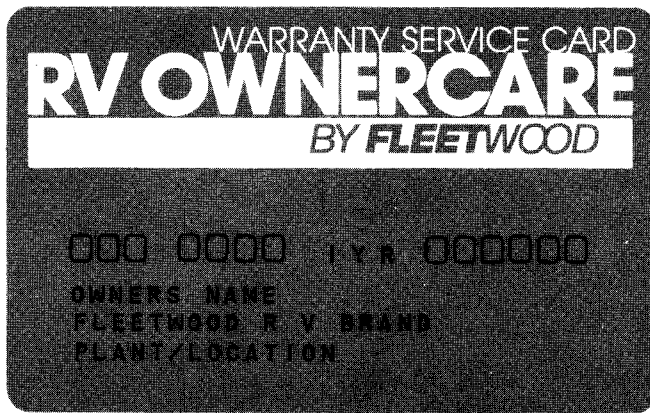

Ownercare Card

MANUFACTURERS OF THESE COMPONENTS.

2. DEFECTS CAUSED BY OR RELATED TO:
  - A. ABUSE, MISUSE NEGLIGENCE OR ACCIDENT;
  - B. FAILURE TO COMPLY WITH INSTRUCTIONS CONTAINED IN THE OWNER'S MANUAL;
  - C. ALTERATION OR MODIFICATION OF THE TRAVEL TRAILER;
3. NORMAL DETERIORATION DUE TO WEAR OR EXPOSURE, SUCH AS FADING OF FABRICS OR DRAPES, CARPET WEAR, ETC.
4. NORMAL MAINTENANCE AND SERVICE ITEMS, SUCH AS LIGHT BULBS, FUSES, LUBRICANTS, ETC.
5. TRANSPORTATION TO AND FROM DEALER OR MANUFACTURING PLANT LOCATION, LOSS OF TIME, INCONVENIENCE, COMMERCIAL LOSS, LOSS OF USE, TOWING CHARGES, BUS FARES, CAR RENTAL, INCIDENTAL CHARGES SUCH AS TELEPHONE CALLS OR HOTEL BILLS, OR OTHER INCIDENTAL OR CONSEQUENTIAL DAMAGES.

SOME STATES DO NOT ALLOW THE EXCLUSION OR LIMITATION OF INCIDENTAL OR CONSEQUENTIAL DAMAGES, SO THE ABOVE

LIMITATION OR EXCLUSION MAY NOT APPLY TO YOU.

**This warranty gives you specific legal rights, and you may also have other rights which vary from state to state.**

**The manufacturer is not responsible for any undertaking, representation or warranty made by any dealer or other person beyond those expressly set forth in this warranty.**

**Corporate Headquarters:**  
 Consumer Affairs Department  
 Fleetwood Enterprises, Inc.  
 P.O. Box 7300  
 Riverside, California 92523  
 From California: (800) 442-4804  
 From Outside of California:  
 (800) 854-4755

**Ownercare Card**

You will automatically receive an Ownercare Card approximately 3-4 weeks after delivery of your new Avion. This plastic card is imprinted with your name, trailer serial number and manufacturing plant location, and should be presented to the dealer whenever service is required.

Always return your coach to the selling dealer for warranty service. If this is not possible, you may contact any other authorized Avion dealer or any authorized Fleetwood dealer having a travel trailer service facility.

While all installed appliances and equipment (except tires and batteries) come under Avion's

warranty, they are also covered by separate warranties of the individual manufacturers. Copies of manufacturers' warranties and operating instructions should be provided by the selling dealer at time of delivery.

We recommend that you contact the manufacturers' own service organizations directly for all warranty adjustments and repairs. If you are unable to locate a convenient service point through their literature or the Yellow Pages, contact your Avion dealer for assistance.

# Maintenance Schedule

Item	Every 1,000 Miles or 30 Days	Every 5,000 Miles or 90 Days	Every 10,000 Miles or 6 Months	Procedure
All Exterior Door Locks	•			Lubricate by shooting in dry graphite.
Axle		•		None, except wheel bearings.
Batteries	•			Check water level—fill with distilled water only.
Brakes			•	Inspect and replace as necessary.
Break Away Switch		•		Lubricate with light household oil.
Folding Step	•			Lubricate moving parts.
Hitch Ball Latch	•			Lubricate with engine motor oil.
Hitch Jack	•			Lubricate with light household oil (put oil can spout up under handle and allow oil to run down post).
LPG System Leak Test		•		See page 61.
Main Door Hinges	•			Lubricate with light household oil.
Overhead Cabinet Struts			•	Lubricate with light household oil.
Range Exhaust Hood				Clean fan blades and wash filter.
Refrigerator Flue Cleaning		•		See page 84.
Roof Vent Elevator Screws	•			Lubricate with light household oil.
Strike Pocket on Main Door	•			Coat with paraffin.
T.V. Antenna	•			Lubricate exterior moving parts with silicon spray.
Tire Rotation		•		See page 37.
Tires	•			Check for foreign objects. Air pressure—page 35.
Water Pump		•		Check belt for wear and proper tension.
Wheel Bearings			•	Clean, repack, and adjust.
Wheel Lug Bolts		•		Check for tightness.*
Window Seals/Door Seals		•		Clean with mild detergent and coat with silicone.
7-Way Plug and Receptacle		•		Clean contacts and coat with a spray cleaner.

\*On new trailers check every 200 miles for the first 1,000 miles.



# Specifications

## Tank and Appliance Capacities

Tank	Capacity
Fresh Water Holding Tank	65 gal.
Rinse Water Holding Tank	30 gal.
Solid Waste Holding Tank	40 gal.
Water Heater	6 gal.

## Bulb Replacement

108

Description	Location	Number
Single square fixture	Center bath, center bath shower and trunk	1141
Dual square fixtures	Ceiling lights and below overhead cabinets	1141
Mirror lights	Rear bath	1143
Indirect lighting	Behind front valance	1141
Interior convenience lights	Below front and rear overhead cabinets, and above entry door	1003
Range hood lights	Over range	1156
Exterior convenience lights	Hitch, roadside rear utility door, and above entry door	T 105
Living room ceiling fixture	Over dining table	1141
Oven light	Oven	15 watt, 12 volt, standard base
Running lights	5 front, 5 rear and side markers	GE 1895
Back-up lights	Taillight housings	1156
Stop/turn and taillights	Taillight housings	1157
License plate light	License plate	GE 67
Reading lights	Divider wall	1176

## Component Specifications

Appliance	Manufacturer	Model
Range and Oven	Magic Chef (Gaffers-Sattler)	BT22JS-4TVX
Refrigerator	Dometic	RM 100
Monitor Panel	Jensen Wemac	Avion
Water Heater	Atwood	G6A-3E
Furnace	Duotherm	65930 Auto Ignition
T.V. Antenna	Braund	Skyliner
Toilet	Thetford	Aquamagic D8445
Electrical Control Center	Progressive Dynamics	PD-735Q28RDTAB
Water Pumps	PAR (ITT Jabsco)	36950
Galley Faucet	Delta	111
Tub Faucet	Delta	636
Lavatory Faucet	Delta	522
Stereo Radio / Tape player	Panasonic	CQS680EU (Cassette)
Microwave Oven	Magic Chef	MW 207-4
Air Conditioner	Duotherm	55915 w/3-15603

109

## Fuses and Circuit Breakers

### Electrical Control Center

12 Volt Circuit Number	Circuit Location	Rating
1	Door side	20 amp
2	Road side	20 amp
3	Ceiling	20 amp
4	Rear	20 amp
5	Monitor Panel POWER ON light	3 amp
6	Outlets, monitor panel, radio, water pump	20 amp

110 Volt Circuit Number	Circuit Location	Rating
1	Main	30 amp
2	Receptacles	20 amp
3	Receptacles	20 amp
4	Air conditioner	20 amp
Radio fuse	Behind Monitor Panel	3 amp
Battery fuse	At batteries	40 amp
Water pump	At pump	7½ amp
Power Jack	At batteries	20 amp



Accessories	3	Dead Bolt	30	Leaving Campsite	22
Adjust-A-Ride	41	Defrosting	83	Leveling	21
Air Conditioner	98	Distribution Panels	72	Leveling Bars	21
Aluminum Skin	30	Dolly Wheel	10	Light Bulb Replacement	108
Amperage Chart	109	Drainage System	54, 68	Lights	50, 74
Automatic Gas Regulator	60	Dump Valves	68	LPG System	54, 60
Axles	41			Loading	4
		Electrical Components	72	Locking Lever	10
Backing Up	14	Electrical Connector	74		
Ball (Hitch)	2, 10	Electrical Inlet	72	Main Door	30
Bathroom	50	Electrical Panels	72	Maintenance Record	107
Bathroom Exhaust Fan	51	Electrical System	72	Maintenance Schedule	106
Batteries	74	Electrical System Diagrams	77	Microwave Oven	90
Battery Charger	72	Electrical Trouble-Shooting	76	Monitor Panel	54
Battery Charging	22, 72	Electric Jack	32		
Battery Condition Tester	54	Equipment List	3	Oven	86
Beds	46	Escape Window	50	Oven Cleaning	87
Break Away Switch	39	Exterior	27	Overheating	15
Brake Adjustment	40	Exterior Care	30	Ownercare	105
Brake Controller	38	Exterior Lights	78, 108		
Brakes	38			Parking	20
Bulbs (Replacement)	108	Fabrics	52	Passing	12
		Fan Switch	48, 51, 87	Pilot Adjustment:	
Cable TV	33	Filter (Air Conditioner)	98	Oven	86
Campgrounds	20	Filter (Water)	62	Range	86
Capacities	108	Flat Tire	36	Power Cable	74
Car Connector	74	Folding Step	32	Power Jack	32
Cargo Capacity	7	Fresh Water Holding Tank	62	Power On	56
Carpeting	52	Furnace	92	Post Jack	10
Ceiling Fans	48	Furnace Trouble-Shooting	94		
Ceiling Vents	48	Fuses	109	Radio	55
Check Lists	10, 22			Radio Antenna	34
Circuit Breakers	72	Gas Leaks Test	61	Range	86
City Power	21, 72	Gas (LPG) System	60	Range and Oven	
Clock	54	Gas Tanks	60	Trouble-Shooting	89
Converter	72	GVWR	4	Range Exhaust Hood	88
Counters	52			Rear View Mirrors	12
Curtitions	48	Hitch	2, 10	Refrigerator	82
		Hitch Ball Height	2	Refrigerator Defrosting	83
		Hitching Up	10	Refrigerator Trouble-Shooting	85
		Holding Tanks	62, 68	Regulator	60
				Removing Moisture	93
		Ice Making	83	Road Conditions	15
		Insulation	18	Roof Vents	48
		Interior Maintenance	52	Running Lights	108
		Jacking Trailer	21, 36, 42		
		Kill Switch	55		

Safety Chains.....	10	Utility Connections.....	21
Screen Door.....	30	Vehicle Weighing.....	4
Screens.....	31	Vehicle Weights.....	4
Self-Contained (Drainage).....	68	Vents.....	48
Self-Contained (Electrical).....	72		
Service.....	104	Walls.....	52
Sewer Connection.....	21, 68	Warranty.....	104
Shower Head.....	50	Waste Disposal.....	68
Sink Maintenance.....	51, 52	Water Drainage Procedure.....	64, 66, 102
Specifications.....	108	Water Drain Valves.....	62, 66, 67
Stabilizing Jacks.....	32	Water Filter.....	62
Storage.....	32	Water Heater.....	63, 95
Summer Traveling.....	19	Water Inlet.....	21, 62
Suspension.....	41	Water Level.....	54
Sway Control.....	2	Water Pump.....	62
		Water Purification.....	63
Tables.....	48	Water Sanitation.....	64
Tank:		Water Systems.....	66, 67
Solid Waste.....	68	Wheels.....	35
Rinse Water.....	68	Wheel Alignment.....	41
Fresh Water.....	62	Weather Conditions.....	18
Tank Capacities.....	108	Weights.....	4
Thermostat.....	92, 93	Windows.....	31
Tire Changing.....	36	Winterizing.....	102
Tire Pressures.....	35	Winter Storage.....	102
Tire Rotation.....	37	Winter Trailering.....	18
Tires.....	35	Woodwork.....	52
Toe-In Adjustment.....	43		
Toilet.....	70		
Tongue.....	10		
Tongue Weight.....	6		
Tow Vehicle.....	2		
Towing Tips.....	12		
Trailer Storage.....	102		
Travelcade Club.....	24		
Trouble-Shooting:			
Air Conditioner.....	99		
Electrical.....	76		
Furnace.....	92		
Range and Oven.....	89		
Refrigerator.....	85		
Water Pump.....	65		
Turning.....	12		
TV Antenna.....	33		
TV Jacks.....	33		