

# EATON VFD MOTOR SPECIFIC PARAMETERS

MODEL: MMX32AA038F0-0 SUPPORT: 800-322-4986

PARAMETER	PSI SETTING	DESCRIPTION	MANUAL PAGE NO.
P7.1*	28 – AMPS (SEE MOTOR TAG)	MOTOR FLA	89
P7.3*	1725 – (SEE MOTOR TAG)	MOTOR RPM	89
P7.4*	0.77 – POWER FACTOR	MOTOR POWER FACTOR	89
P7.5*	230 – VOLTS	INCOMING OPERATING VOLTAGE	89
P7.6*	50.00 HZ	MOTOR FREQUENCY	89

\*User setting for these parameters are approximate and should be set by referencing motor tag and incoming power source.

Other Considerations when installing this drive.

- Pressures- for 8-10GPM you can typically set pressures around 1650psi
- Pump should be 8-10 GPM. If using a bigger pump you may need to lower pressures to below 1650psi to keep drive from bogging down.
- Use a pressure switch and set 150-200psi below relief pressure to prevent deadhead- especially if the amps are close to 50.
- You should be able to start the unit with the hoses disconnected (at relief pressure). If you can't you should reduce the relief pressure until you can.
- If you have a 3 position open or tandem center valve you can set T5 for 03.00 so the compactor will start in an unloaded position. This is especially helpful if the power is 208V.

# Parameters

## Setting Parameters









The following table is a good example of the general execution for selecting and setting parameters.

When the MMX is switched on for the first time, it activates the Quickstart Wizard to guide you through specific parameters. (See as per "Step" 2.)

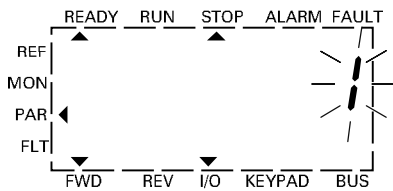
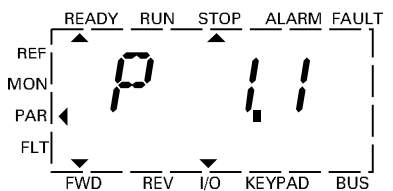
### Setting Parameters

Sequence	Commands	Display	Description
0			<p>Measured value 1.1</p> <p>The display changes automatically with the value of the output frequency 0.00 Hz (at STOP)</p>
1	     		<p>By actuating the BACK/RESET button, you activate the menu level (arrow flashes)</p> <p>The two arrow buttons enable you to select the individual main menus:</p> <ul style="list-style-type: none"> <li>REF = Setpoint input (reference)</li> <li>MON = Operational data indicator (monitor)</li> <li>PAR = Parameter levels</li> <li>FLT = Fault log (Fault)</li> </ul> <p>Use the OK button to open the selected main menu</p>
2		<p style="text-align: center;">↓</p> <p style="text-align: center;">Display in Automatic Alternation</p> <p style="text-align: center;">↑</p>	<p>The numerical first value is always shown from the selected main menu</p> <p>Example: Main menu PAR, Parameter P1.1</p> <p>The display automatically switches between the parameter number and the defined value</p> <p>P1.1 = 1 is displayed at the first switch on and after the factory settings have been activated</p> <p>Use the OK button to activate the selected parameter.</p> <p>The value (1) flashes</p> <p>P1.1 = 1:</p> <p>The Quickstart Wizard is activated and guides you step-by-step through the specific drive parameters (see <b>Page 65</b>)</p>

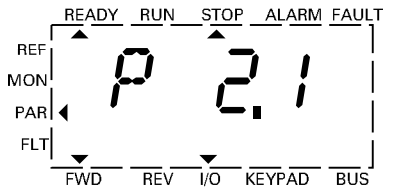
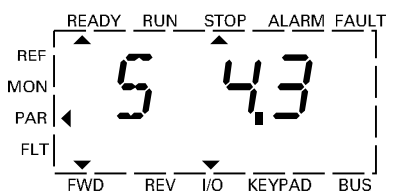
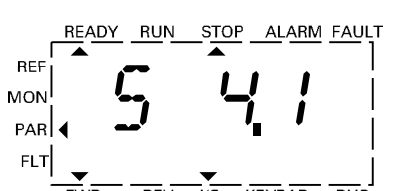
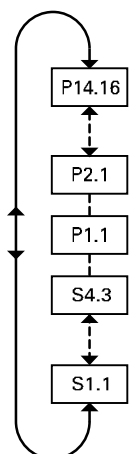
Setting Parameters, continued

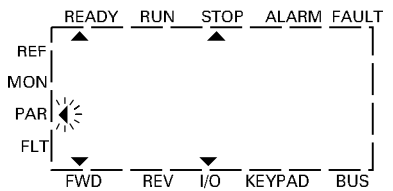
Sequence	Commands	Display	Description
3	  	 	<p>If the parameter value is flashing, you can use the two arrow keys to change the value within the permitted range</p> <p>P1.1 = You exit the Quickstart Wizard (access to all parameters)</p> <p>The selected value is confirmed with the OK button</p> <p>The display now changes automatically between the new value and the respective parameter number</p>
4	   	  	<p>The other parameters in the main menu PAR can be selected with the two arrow buttons (&lt; or &gt;) (closed circuit, Example: Factory setting)</p>  <p>The arrow buttons (&lt; and &gt;) enable you to select the first parameter of each parameter group</p> <p>&gt; P1.1, P2.1, P3.1, P4.1, ...</p> <p>&lt; S4.1, S3.1, S2.1, S1.1, P14.1, ...</p>
5			<p>By actuating the BACK/RESET button, you exit main menu PAR (arrow flashes, see sequence 1)</p>

All settings are stored automatically by actuating the OK button.

Parameters marked in the "Access Right RUN" column with ✓, can be changed during operation (RUN mode).

# Parameters

## Parameter Menu (PAR)

You have access to all M-Max parameters in the parameter menu (PAR) (see “List of Parameters” on **Page 161**).

### Parameter Menu (P1.1 = 1, Quick Configuration)

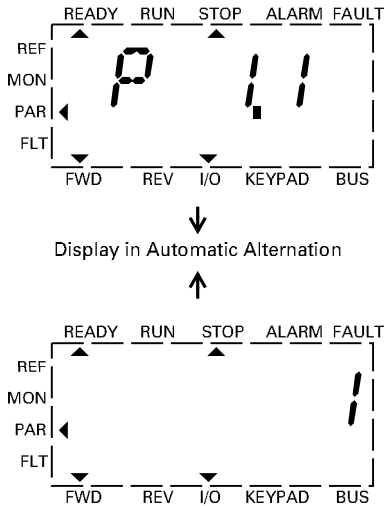

The parameter menu always starts with the parameter P1.1.

P1.1 = 1 means that you are guided through the parameters by the Quickstart Wizard. Here you must confirm a specified number of parameters individually (see **A**).

P1.1 = 0 gives you free access to all parameters (see **B**).

### Schematic Representation of Parameter Access

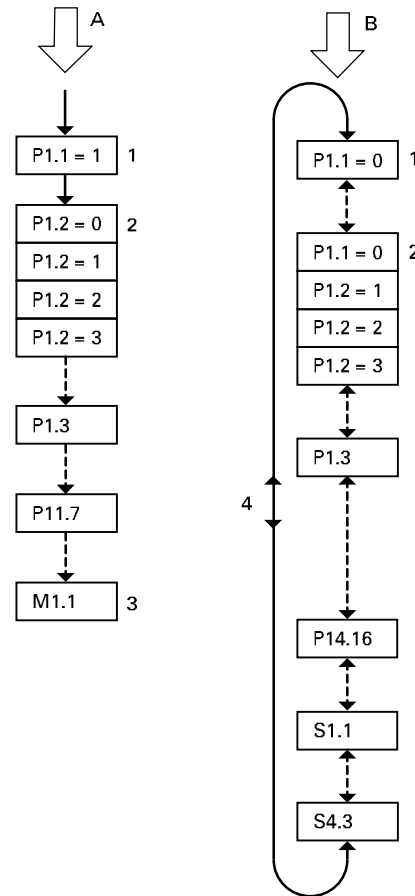

Item Number	Description
<b>A</b>	Guided access and selected parameters with the Quickstart Wizard (use OK button to move further)
<b>B</b>	Free access to all parameters (move further using the four arrow buttons)
<b>1</b>	Parameter conceal selection P1.1 = 1 (Factory setting) The quick start assistant guides you to the selected parameters (predefined parameter change) P1.1 = 0 allows access to all parameters (free parameter selection)
<b>2</b>	Selection of pre-defined parameter values for various applications (see table on <b>Page 66</b> ) P1.2 = 0: Basic, no preliminary setting P1.2 = 1: Pump drive P1.2 = 2: Fan drive P1.2 = 3: Feed unit (high load)
<b>3</b>	Completion of the quick configuration and automatic switch to frequency display Selecting the PAR menu level again allows the free selection of the required quick configuration parameters and the system parameter (S)
<b>4</b>	Free selection of all parameters (P1.1 = 0) with the two arrow buttons ^ and v or < and >

**Brief Instructions: Steps to the Motor Start**

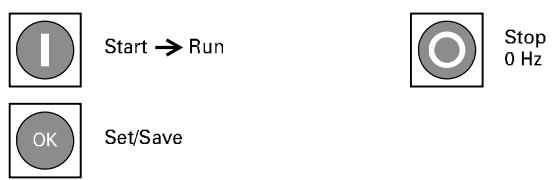
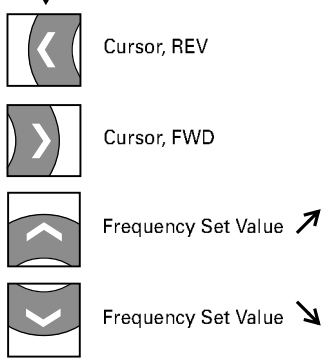
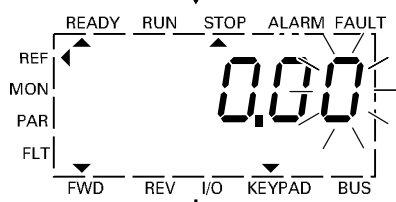
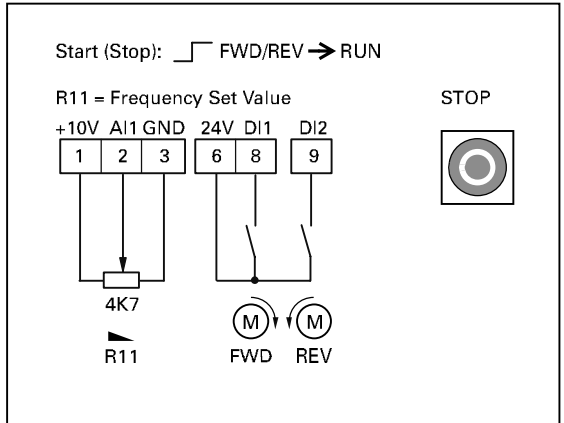
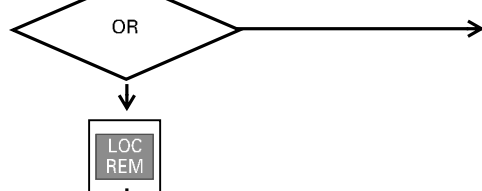
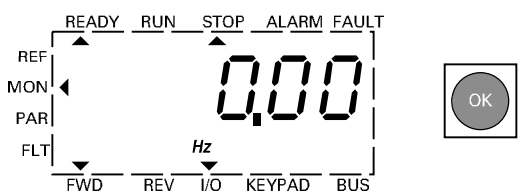
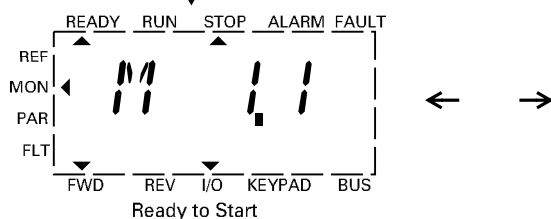
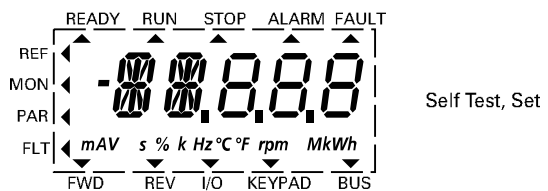

## Error and Warning Messages

### Introduction

M-Max frequency inverters have several internal monitoring functions. When deviations from the correct operating status are detected, faults (FAULT) and warning messages (ALARM) are differentiated between.

### Error Messages

Faults can cause defective functionality and technical defects. The inverter (frequency inverter output) is automatically disabled if a fault is detected. After this, the connected motor comes to a stop freely.

Error messages are shown on the display with an arrowhead ▲ under FAULT and with the error code F... (F1 = last fault, F2 = second to last, and so on).

### Example of an Error Message (Undervoltage)

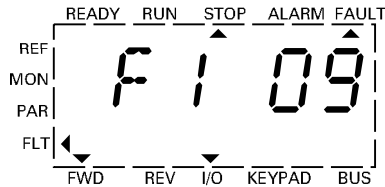

### Acknowledge Fault Message (Reset)

The current error message flashes (for example, F1 09). It can be acknowledged by pressing the OK button followed by BACK/RESET or by actuating DI5 (default settings control signal terminal 15). The displayed error then automatically stops flashing, the four horizontal bars (Reset) are shown and the error message is then displayed continuously. The arrow point ▲ underneath FAULT disappears.

### **WARNING**

**If a start signal is present, the drive is restarted automatically, if P3.1 = 0 is set (REAF = Restart after FAULT) and the error message has been acknowledged (Reset).**

The current fault message indication (F1...) is cleared when the supply voltage is interrupted or when you press the OK button followed by BACK/RESET. The indication goes out and the arrow tip ◀ flashes at menu level MON.

### Fault Log (FLT)

The last nine faults can be called up and shown in succession in the fault log (FLT).

Select the FLT menu level (◀). Use the arrow buttons ^ and v to call the faults F1–F9 individually. Every error message is stored with the time of the error occurrence under d (day), H (hour) and m (minute). The call is made with the OK button, and the selection with the ^ and v arrow buttons.

The content of the error memory is cleared when the factory setting is activated. When you press the BACK/RESET button, the display of the menu level (◀) flashes and the STOP button is held down for around 5 seconds.

Activating the factory settings will reset all parameters.

### Alarm Messages

A warning message signals possible damage and indicates impending errors that can still be prevented, such as an excessively high temperature rise.

Warning messages appear on the display with an arrow ▲ under ALARM and AL with the respective code number. The code numbers for faults and warning messages are identical.

### Example of an Alarm Message

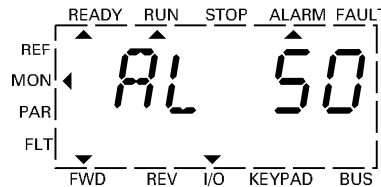

If a warning message occurs, the frequency inverter remains active (READY, RUN).

In the given example (AL 50 = current setpoint signal 4–20 mA interrupted), the drive stops following the absence of a reference value. If no more measures are introduced because of the warning message (for example, a shutdown), the drive can start again automatically in the example AL 50 when the current signal returns (for example, a contact fault in the signal line).

The alarm message (AL) is displayed alternating with the active operational display value.

The table on **Page 57** shows the error codes, their possible causes, and indicates correction measures.

**List of Fault Messages (F) and Warning Messages (AL)**

Display	Designation	Possible Cause	Instructions
01	Overcurrent	The frequency inverter has detected an excessive current (> 4 x I <sub>N</sub> ) in the motor cable Sudden load increase Short circuit in motor cable Inadequate motor	Check the load Check the motor size Check the cable (See parameter P6.6)
02	Overvoltage	The DC intermediate circuit voltage has exceeded the internal safety limit The delay time is too short High overvoltage peaks in line power	Increase braking time
03	Ground fault	An additional leakage current was detected when starting by means of a current measurement Insulation fault in the cables or in the motor	Check the motor cable and the motor
08	System fault	CPU error message Internal communication fault	Reset error: Switch input voltage off and on (restart) ① If the fault occurs again, contact your local representative
09	Undervoltage	The DC intermediate circuit voltage has exceeded the internal safety limit Probable cause: The supply voltage is too low Internal device fault Power failure	If a brief power failure takes place, reset the fault and restart the frequency inverter Check the supply voltage. If it is okay, there is an internal fault If this is the case, contact your local representative
13	Undertemperature	The IGBT switch temperature is below 14°F (–10°C)	Check the ambient temperature
14 ②	Overtemperature	The IGBT switch temperature is above 248°F (120°C) An excessive temperature warning is issued if the IGBT switch temperature goes above 230°F (110°C)	Make sure that there is an unobstructed flow of cooling air Check the ambient temperature Make sure that the switching frequency is not too high in relation to the ambient temperature and to the motor load
15	Motor stalled	The motor blocking protection mechanism has been triggered	Check the motor
16	Motor overtemperature	The frequency inverter's motor temperature model has detected motor overheating. The motor is overloaded	Decrease the motor load If the motor is not overloaded, check the temperature model parameter
17	Motor underload	Motor idle, connection to load machine interrupted (for example, torn drive belt)	This function must be activated at P8.5. The overload message is set at P8.12 and P8.13
22	EEPROM checksum error	Error when storing parameters Malfunction Component fault Error in microprocessor monitoring	Contact your local Eaton representative
25	Watchdog (API)	Error in microprocessor monitoring Malfunction Component fault	Reset the fault and restart If the fault occurs again, contact your local representative
27	Back EMF	Electromotive force The voltage induced in the motor with the rotation is greater than the output voltage of the frequency inverter	The rotation energy is greater than the braking energy Lengthen deceleration times Switch on brake chopper and braking resistor Use higher rated frequency inverters
35	Application error	The application is not working	Contact your local Eaton representative
41	IGBT overtemp	The IGBT switch temperature is above 248°F (120°C) An excessive temperature warning is issued if the IGBT switch temperature goes above 230°F (110°C)	Make sure that there is an unobstructed flow of cooling air Check the ambient temperature Make sure that the switching frequency is not too high in relation to the ambient temperature and to the motor load

**Notes**

- ① There are subcodes associated with this error. To get the subcode scroll to the M (minute) value within the fault menu. The value listed is the subcode.
- ② Power software ≤V018 IGBT overtemperature. Power software ≥V019 heat sink overtemperature.

## Error and Warning Messages

### List of Fault Messages (F) and Warning Messages (AL), continued

Display	Designation	Possible Cause	Instructions
50	Live zero error (analog input)	Monitored zero point Current less than 4 mA, voltage less than 2V Signal cable interrupted The signal source is faulty	Check the analog setpoint circuit and current and voltage source (see parameter P2.1, P2.5, P8.1, P8.10)
51	External fault	Error message at a digital input (DI1–DI6), programmed as input for an external error message	Check the programming (P3.5, P3.6) and check the device indicated by the error message Check the cabling for the respective device as well
53	Fieldbus error	The communication link between the master device and the drive's fieldbus has been interrupted	Check the installation Further notes are provided in the manual of the optional fieldbus interface (CANopen, PROFIBUS DP, and so on) If the installation is okay, contact your local representative
54	Fieldbus interface error	MMX-NET-XA mounting frame for fieldbus interface cards is not connected to the frequency inverter Optional fieldbus interface is not fitted	Error message with activated fieldbus connection of the interface between the frequency inverter and the mounting frame (MMX-NET-XA) Error message as per P8.15 Further notes are provided in the optional fieldbus interface manual (CANopen, PROFIBUS DP, and so on)









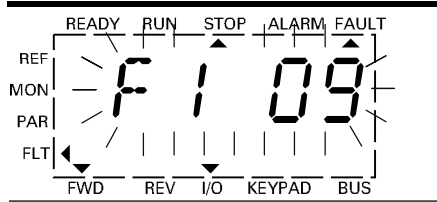

**Acknowledge Fault (Reset)**

By switching the supply voltage off, the error message (F, FAULT) is acknowledged and reset. The error code with the respective operating times (d = days, H = hours, M = minutes) remains stored (FLT).

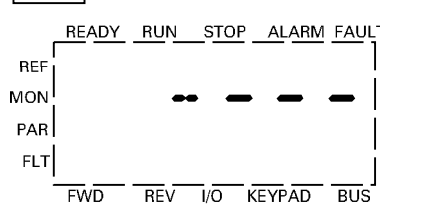
In the factory setting, you can also acknowledge the error with a 24 Vdc signal on terminal 15 (DI5 = Reset). The error code is not deleted in this case.

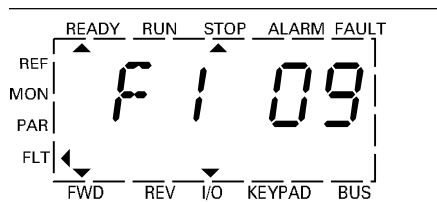
The following table shows the required operations for acknowledging an error message via the operating unit.

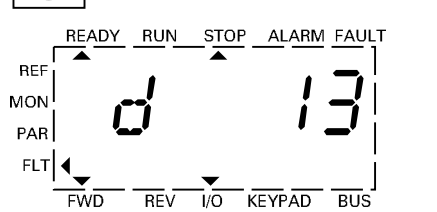
**Error Messages via Operating Unit**

Operating Unit Element	Explanation
	<p>F1 = Current fault message (flashing display) 09 = Undervoltage (example)</p>
  	<p>Actuate the BACK/RESET button or terminal DI5 (reset) to acknowledge the error message</p>
	<p>The acknowledged fault message is displayed with READY and the failure code</p>
 	<p>By actuating the OK button, the number of operating days (for example, d = 13 days) until this fault message is displayed. You can also show the respective hours (H) and minutes (M) of operation with the arrow button <math>\nabla</math></p>
	<p>You exit the fault log (FLT) with the BACK/RESET button. The <math>\blacktriangleleft</math> arrow moves to MON in the menu level.</p>
	<p>Use the OK button to activate the operating data display now or select another menu level with the arrow keys <math>\wedge</math> or <math>\vee</math></p>