

Rainsoft Division of Aquion, Inc.
2080 East Lunt Avenue
Elk Grove Village, Illinois 60007
1.847.437.9400 or 1.800.860.7638
www.rainsoft.com

Rain Soft®

Taking the Worry Out of Water ...Since 1953

AIRMASTER^{ULTRA}™



Limited
Lifetime Warranty

For as long as you own the equipment

RainSoft Division of Aquion, Inc., believing its

AIRMASTER ULTRA SYSTEM

to be of exceptional quality, hereby warrants said equipment to its first purchaser at retail as follows:

THE AIRMASTER ULTRA SYSTEM IS WARRANTED AGAINST DEFECTS IN MANUFACTURE FOR THE LIFETIME OF THE FIRST PURCHASER AT RETAIL.

THE ELECTRICAL ITEMS ARE WARRANTED AGAINST DEFECTS IN MANUFACTURE FOR FIVE YEARS AND PRO-RATA WARRANTED FOR AN ADDITIONAL FIVE YEARS.

THE EXPENDABLE ITEMS, SUCH AS GERMICIDAL LAMPS AND OZONE LAMPS, ARE NOT WARRANTED FOR ANY LENGTH OF TIME.

This warranty begins at the time the equipment is first connected for use, and is contingent upon the return of a signed owner's registration card.

This warranty does not require replacement of the entire unit. If the equipment does not perform properly, you should request service from the dealer that sold you the equipment. If you are not satisfied, you should notify our Customer Service Manager. If we are not able to arrange local servicing, you should send the defective part(s) (or, if you prefer, send the entire unit,) directly to the manufacturer, freight prepaid, with proof of purchase and a copy of this warranty. The defective part(s) will either be repaired or new AirMaster Ultra part(s) furnished, for a nominal charge to cover labor, handling, packing and the increase, if any, in the retail price of the part(s) since the date of purchase. Broken lamps due to shipping or installation handling are not covered. Genuine AirMaster Ultra parts must be used. Failure to use genuine AirMaster Ultra parts will void the warranty and certifications.

This warranty does not include labor charges, and does not cover installation, transportation, or any other claims or torts. Some states do not allow the exclusion or limitation of incidental or consequential damages, so parts of the above limitation or exclusion may not apply to you.

This warranty gives you specific legal rights, and you may also have other rights which vary from state to state. You also have implied warranty rights. In the event of a problem with warranty service or performance, you may be able to go to a small claims court, a State court, or a Federal District Court.

This warranty is void if equipment is not installed and operated according to instructions. It does not apply to damage caused by abuse, accident, neglect, freezing, fire, or other abnormal conditions beyond the company's control. This warranty is void on any part from which the manufacturing date has been removed or made illegible.

Benefits will be provided by various types of RainSoft equipment when installed and operated according to the manufacturer's recommendations. Operational, maintenance and replacement requirements are essential for the product to perform as advertised. All claims are based on the best available information at the time of printing. Manufacturer makes no representations as to the suitability of this equipment for a particular application. Buyer relies entirely on the Dealer's recommendations in the purchase of this equipment.

Independent RainSoft Dealers may include, together with your RainSoft product, a product or component that is not manufactured by RainSoft or their parent company, Aquion, Inc. Any non-RainSoft product may be covered by the manufacturer of that product, and is not covered by the RainSoft warranty. Aquion, Inc. does not warrant that your RainSoft product and the non-RainSoft product will perform properly when used together, and assume no liability therefore.

RainSoft Division of Aquion, Inc.
2080 East Lunt Avenue
Elk Grove Village, Illinois 60007 USA
1.847.437.9400 or 1.800.860.7638

TABLE OF CONTENTS

Warranty	1
Enjoying Your Airmaster Ultra Unit	3
Important Safety Instructions	3
Unpacking Your Airmaster Ultra Unit	4
Airmaster Ultra Installation	5
Choosing the Appropriate Sensitivity	6
Setting the Appropriate Sensitivity	6
Adjusting the Ozone Output Level	7
Maintenance Requirements	8
Airmaster Ultra Parts List	9
Specifications	9
Troubleshooting Guide	10
Installation Information	11
Rectangle Installation Template	12
Hole Saw Installation Template	13

Congratulations! You now own the finest whole-house air treatment system available to homeowners.

To make operating and maintaining your unit as simple as possible, please read the contents of this Owner's Manual.

This unit was shipped from the factory ready for operation and will begin delivering cleaner, fresher air the instant your heating/cooling system is turned on.

This unit is designed to help remove household odors ranging from food, tobacco smoke, pets and other objectionable smells that may be present in your home.

To receive optimal benefit and performance from the unit, your furnace or air conditioner fan should be in the "ON" position at all times.

IMPORTANT SAFETY INSTRUCTIONS

Always make sure the system is unplugged during installation or service procedures.

WARNING: The ultraviolet light produced by the UV lamps is harmful to the eyes. Do not look directly at the lamps. Should it become necessary to look at the lamps, use UV-protected sunglasses.

The AirMaster Ultra may be installed either in the main return duct or main supply duct as shown in the diagram. When installing on the supply side, locate it as far away from the heating source as practical while remaining in the main air stream.

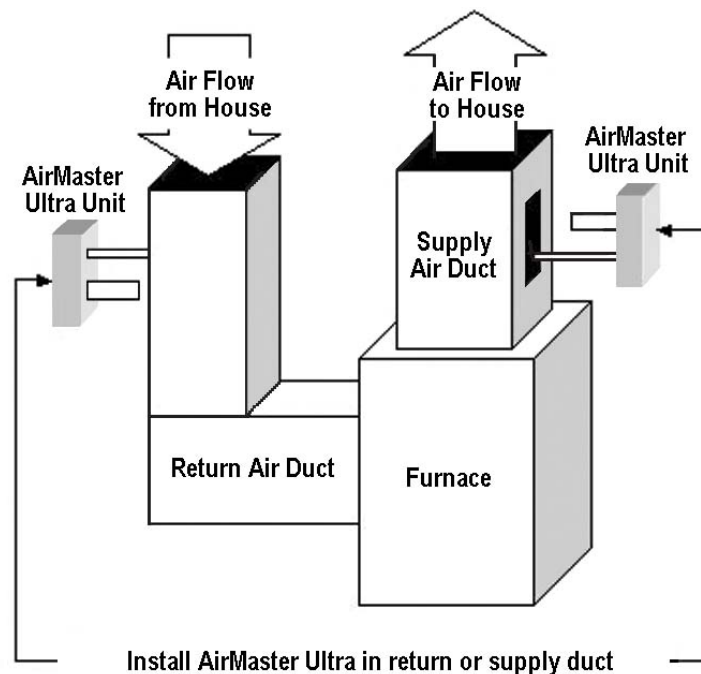

UNPACKING THE AIRMASTER ULTRA UNIT

1. Each unit is shipped with the cover separated from the main chassis assembly. This allows for the main chassis assembly to be ready for installation.

2. Carefully remove unit from the package. The lamps are fragile and proper care must be taken when removing the packaging that is placed around them.

3. Do not touch the lamps with your bare hands, as oils from your hands can create “hot spots” which reduce the lamp life. In case of contact with the lamp, wipe the lamp clean with a soft cloth dampened with rubbing alcohol.

4. Check the parts list below to make sure you have all of the following:

- One Airmaster Ultra air treatment system
 - Main chassis assembly
 - Cover
 - Two cover attachment screws
- One wall-mount transformer
- Four self-tapping screws
- Installation/owners manual
 - Warranty card
- Wiring to connect from transformer to unit (20', two-conductor cable with plug)
- 2 crimp terminals
 - Wire tie

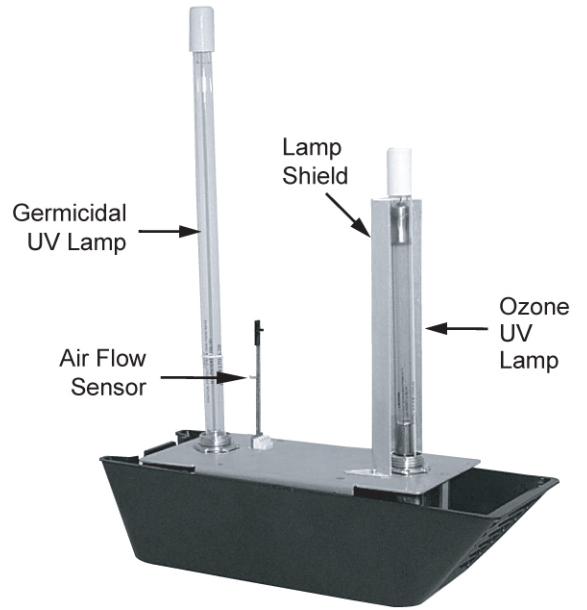

Side View

Main Chassis Assembly with Cover Removed

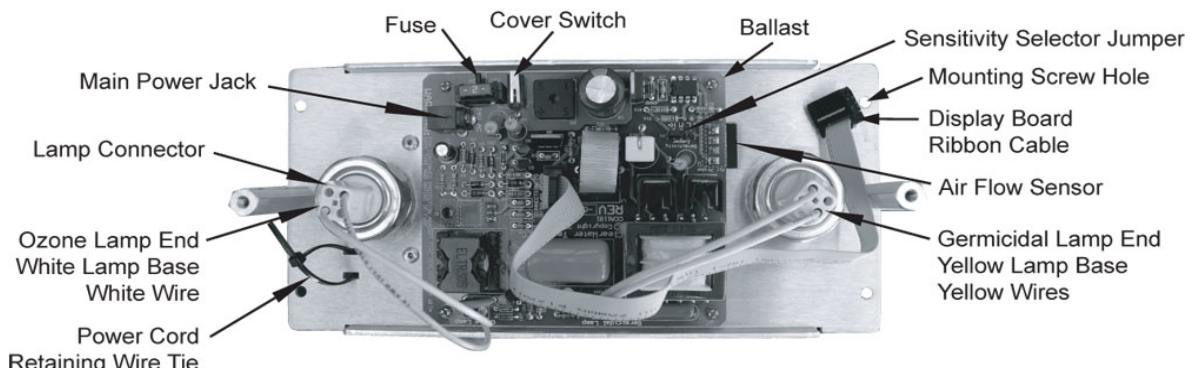

Cover



AIRMASTER ULTRA INSTALLATION

While performing installation procedures all power to the unit must be ‘Off’ and there must be no airflow through the heating/cooling system.

1. One of two templates may be used for installation of the AirMaster Ultra.
 - ‘Rectangle Installation Template’ located on page 12.
 - ‘Hole Saw Installation’ located on page 13.
2. Center the installation template on the ductwork using tape. **Note: The installation template and unit must be mounted lengthwise on the duct.**
3. **Rectangle Installation Template:** Trace the cut out hole pattern on to the ductwork and mark holes for the four mounting screws. **Hole Saw Installation Template:** Mark holes for the four mounting screws and two lamp holes.
4. Cut out openings in ductwork for the unit. See template for more detailed instructions and recommended tools.
5. Choose high, medium, or low sensitivity using the sensitivity selection jumper. Refer to page 6 for detailed instructions.
6. Position AirMaster Ultra ‘Main Chassis Assembly’ into ductwork and secure with the self tapping screws provided, using a 5/16” nut driver.
7. Cut the two-conductor power cord to length, strip ends back 3/8” and crimp on the two fork connectors provided.
8. Slide fork connectors under transformer screw-heads and tighten.
9. Insert the power cord through the cord retaining wire tie (located next to the ozone lamp). Plug power cord into the main power jack.
10. Allow for a service loop in the power cord between the wire tie and the main power jack. Then draw the wire tie tight around the power cord. **Note: Cut off any excess of the wire tie with side cutters. Do not cut the power cord.**
11. Plug the display board ribbon cable into the display board, located under cover and secure cover to main chassis. Assemble using the two screws provided.
12. Plug the transformer into a non-switched 120 VAC outlet. **Note: All lights will remain on for 30 to 120 seconds. After this time the ‘Airflow’ and ‘Odor Neutralizer’ lights will turn off. If the unit does not turn off, you may need to lower the sensitivity setting. Refer to Choosing the Appropriate Sensitivity, page 6, and adjust the sensitivity accordingly.**
13. Turn ‘On’ heating/cooling system and allow it to operate for five minutes, at this time all lights should illuminate. If the unit does not turn on, you may need to increase the sensitivity setting. Refer to Choosing the Appropriate Sensitivity, page 6, and adjust the sensitivity accordingly.
14. Turn ‘Off’ heating/cooling system; the AirMaster Ultra will shut down within 5 to 30 seconds. After this time the ‘Airflow’ and ‘Odor Neutralizer’ lights will turn off. The ‘Power’ and ‘Germicidal’ lights will remain on when unit is not in operation.
15. The AirMaster Ultra is now ready for use.

Note: Ozone air treatment occurs only when air is circulating through the heating/cooling system. For maximum effectiveness and continuous air purification, turn the thermostat “fan” controller switch from the AUTO position to the ON position. Open windows or doors and dirty ductwork may diminish the unit’s effectiveness.

CHOOSING THE APPROPRIATE SENSITIVITY

The AirMaster Ultra is designed with an installer selected air flow probe sensitivity jumper, to provide proper operation with a wide range of residential air handlers.

There are three different settings. Out of the box, the unit will be set to have high sensitivity.

High (H*) – Default setting. Use in most homes of average size.

Medium (M) – Use in homes with larger heating/cooling systems, especially when unit is installed in an environment, such as an attic, that will exceed 110°F.

Low (L) – Use in large homes with multiple heating/cooling zones, especially when unit is installed in an environment, such as an attic, that will exceed 110°F.

Note: The sensitivity is intended to be set during installation, though it can be changed after installation.

If the unit is installed, but does not shut down within 1 minute of the heating/cooling system turning ‘Off’, the sensitivity setting should be lowered one step.

If the heating/cooling system is ‘Off’ and the sensitivity setting has been moved all the way to low and after 1 minute the unit remains ‘On’, this means there is at least 150 ft/min of natural air circulating in your duct. The ozone lamp can safely remain on, and the unit will provide continuous sanitation and odor removal.

SETTING APPROPRIATE SENSITIVITY

Warning: Components near sensitivity jumper may be hot immediately after operation. Use tool to move jumper, or unplug unit and wait for unit to cool before making adjustments.

To access the jumper, the cover must be removed.

The sensitivity jumper is located and labeled on the board near the germicidal lamp (yellow base), as shown in the picture.

The three settings, High (H*), Medium (M), and Low (L), are selected by moving the jumper onto the two pins indicated by that setting, as seen below.

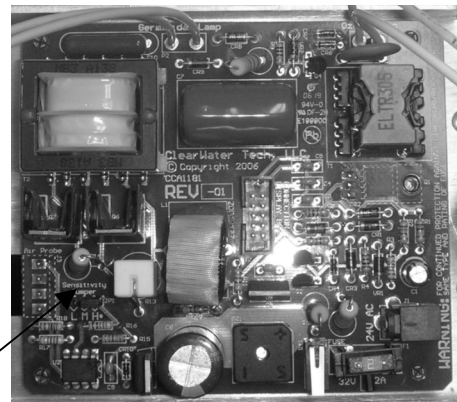

Sensitivity Jumper

High Sensitivity Setting

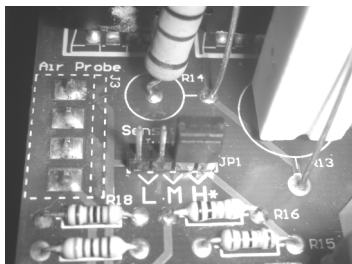

Medium Sensitivity Setting

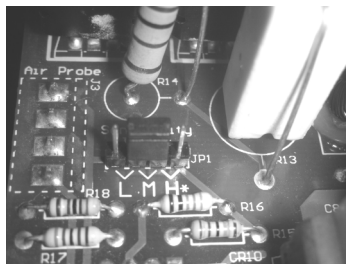

Low Sensitivity Setting

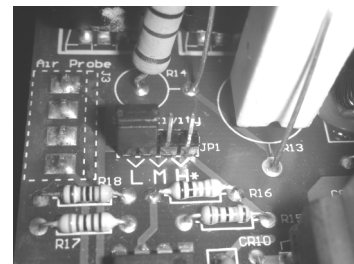

ADJUSTING THE OZONE OUTPUT LEVEL

The slide switch on the cover is used to adjust the ozone output level. The settings are low, med and high.

LOW – Use in an average-sized home with no pets, no tobacco smoke odors and minimum household odors.

MEDIUM – Use in an average-sized home with pets, confined tobacco smoke odors and minimum household odors.

HIGH – Use in an average-sized home with pets, heavy tobacco smoke odors throughout the home and moderate household odors.



MAINTENANCE REQUIREMENTS

The lamp cleaning schedule is determined by air quality. The recommended cleaning interval is every 12 months. The lamp replacement schedule is based on running time. The recommended replacement interval is 24 months. **Note: Do not touch the lamps with bare hands. Oils from the hands can create “hot spots” which reduce the lamp life. Handle by either the end caps or use a soft cloth. In case of contact with the lamp, wipe the lamp clean with a soft cloth dampened with rubbing alcohol.**

CLEANING THE LAMPS: Recommended every 12 months

1. Unplug the transformer from the wall outlet.
2. Remove the two screws from the cover of the unit and remove the cover.
3. Remove the four sheet metal mounting screws from air duct.
4. Carefully remove the unit from the air duct.
5. Using a soft cloth dampened with rubbing alcohol, wipe down the unit and the lamps. If there is a large buildup of dust particles, you may wish to use a can of compressed air first to remove the majority of the dirt.
6. Carefully replace unit into air duct.
7. Replace sheet metal screws, the cover, the two screws and plug the transformer into the wall outlet.

REPLACING THE LAMPS: Recommended every 24 months

NOTE: Use only RainSoft-approved lamps for replacement. Standard off-the-shelf lamps are not compatible with your RainSoft AirMaster Ultra unit.

1. Unplug the transformer from the wall outlet.
2. Remove the two screws from the cover of the unit and remove the cover.
3. Disconnect the lamp connector from the end of the lamp.
4. Loosen the lamp lock nut from around the end of the lamp on the inside of the unit by turning it counterclockwise and remove (pliers may be required).
5. Remove the metal washer.
6. Remove lamp by grasping the rubber bushing around the end of the lamp. With a gentle rocking motion, loosen the bushing from its seat and carefully slide it straight out.
7. Remove the rubber bushing from the old lamp and install it on the new lamp.
8. Slide the new lamp back into the lamp opening. Handle lamp by the end cap(s).
9. Re-install the metal washer and lamp lock nut. Carefully tighten the lamp lock nut.
10. Reconnect the lamp connector to the end of the lamp.
11. Repeat steps #3 to #10 when replacing the other lamp.
12. Replace the cover and secure it with the two screws.
13. Plug the transformer into the wall outlet.

AIRMASTER ULTRA PARTS LIST

1	AirMaster Ultra Assembly	65052
2	AirMaster Ultra Ozone Lamp	65501
3	AirMaster Ultra Germicidal Lamp	65048
4	AirMaster Ultra Fuse.....	65005
5	AirMaster Ultra Flow Sensor.....	65061
6	AirMaster Ultra Ballast (Board).....	65062
7	AirMaster Ultra Transformer.....	65000
8	AirMaster Ultra Display (Board).....	65063
9	AirMaster Ultra Ribbon Cable.....	65064

SPECIFICATIONS

Ozone Lamp

Ozone lamp is 185 nm, cold cathode.

Average life is 20,000 hours.

Germicidal Lamp

Germicidal lamp is 254 nm, hot filament.

Average life is 20,000 hours.

Input

24 Vac, 60 Hz, 50VA

TROUBLESHOOTING GUIDE

SYMPTOM	SOLUTION
No power	Verify cover is properly mounted (unit will not function without cover installed.) Verify that the transformer is properly plugged into wall outlet and the power cord into the power jack on unit. If the cord is properly connected, test the wall outlet with AC tester to make certain it is functioning properly. If not working, consult an electrician.
If unit still does not function	<p>If there is power to the wall outlet, remove cover from the Airmaster Ultra unit; unplug the power cord from the power jack on the AirMaster unit. Using a voltmeter, measure the AC voltage from the transformer. Make sure the voltage is 21 to 26 volts. If not, replace the transformer. (Item # 7, Page 9).</p> <p>If unit is still not working, remove cover from the AirMaster unit and check the fuse on the circuit board. If fuse is blown, replace (Item # 4, Page 9).</p> <p>Check the power light. If light is still not 'On', replace the ballast (Item # 7, Page 9).</p>
Ozone lamp does not turn on when heating/cooling system turns on	Increase the sensitivity as described on page 6, Choosing the Appropriate Sensitivity. Make sure the unit is in the airflow.
Testing the lamps	Testing the lamps requires the heating/cooling system to be running. If ozone lamp is not lit, replace (Item # 2, Page 9). If the germicidal lamp is not lit, replace (Item # 3, Page 9). If this does not work, replace the ballast (Item # 6, Page 9).
Ozone lamp does not turn off when heating/cooling system turns off	Lower the sensitivity as described on page 6, Choosing the Appropriate Sensitivity. If the unit is already on Low sensitivity, there is an airflow of at least 150 ft/min in the duct, which is enough air flow to safely operate the ozone lamp. This natural circulation will allow the unit to continuously clean the air in your home.

If above testing does not work, contact your local RainSoft Dealer.

Attention Installer

Important Information Regarding the Installation of this Product

There are several configurations and many types of installations for AirMaster systems.

The AirMaster can be installed in either the return or supply duct, and in some cases, modifications to the incompatible material can be made. It is important that the below guidelines are followed to prevent applications that may cause damage to the structure.

1. The installation must prevent UV damage (oxidation) of surrounding surfaces within the sphere of influence of the UV bulb. UV light will oxidize anything it comes in contact with that is not UV resistant.

The only surfaces that the UV light should be exposed to are inside of the ductwork (sheet metal, fiberglass, or UV protected material). If there are surfaces within the ductwork that will be exposed to the UV light that are not UV resistant i.e. plastic or wiring, they should be shielded to prevent long-term deterioration. In some cases, installation of foil tape on the exposed surfaces can act as a reflective surface, resistant to UV oxidation.

2. UV light should never penetrate into the living area. Any light that penetrates into the living area is an extreme hazard, potentially causing damage to the eyes of anyone who is exposed to the UV light—especially small children!

If the AirMaster is installed near a register, it must be installed in such a way as to prevent any direct exposure from the UV light into the living area. This will also prevent any UV damage to flooring, upholstery, etc.

If the UV light is penetrating into the living area, the installation of a deflector or filter material is necessary. This will stop the UV light from shining onto surfaces outside of the ductwork.

3. Never install an AirMaster in a furnace or air-handler. The AirMaster is designed to be installed in the ductwork only. Mounting an AirMaster through the side wall of any manufactured HVAC unit may void the warranty. (UV light will damage circuit boards, wiring, etc.)
4. If it is necessary to extend the wire to the transformer, please do not use bell wire. Extension cords to connect the transformer are also not recommended. An output extension cord with RCA jacks is available, part #65043. The wire can also be extended with 18-2 wire, part #18566, at a maximum length of 50 feet.
5. The AirMaster must be installed in the airflow stream. Installing the AirMaster out of the airflow stream may cause an inoperative flow sensor.

Please contact Technical Support for additional information on the installation of AirMaster systems.

RECTANGLE INSTALLATION TEMPLATE

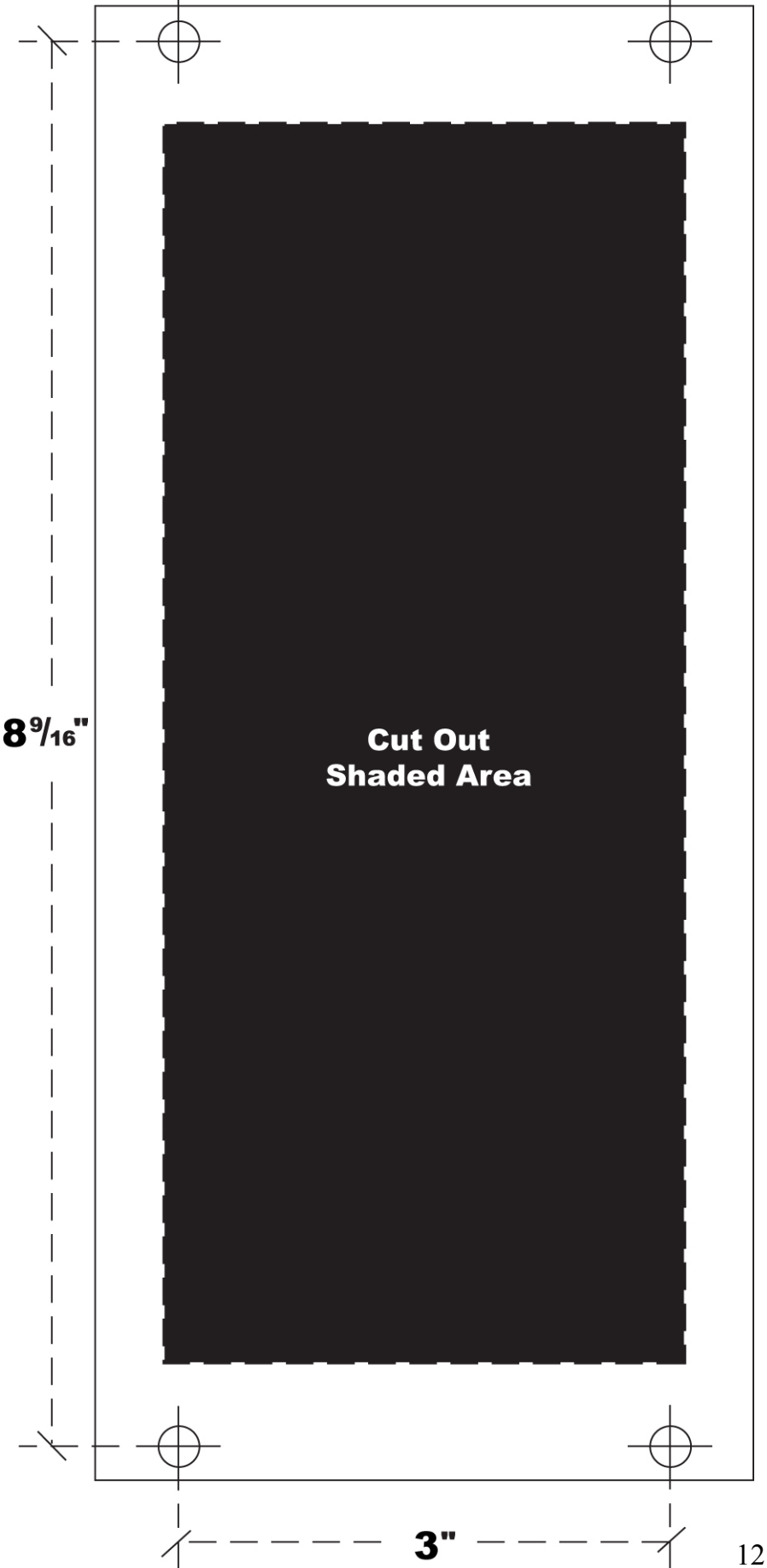

1. Cut out shaded area.
2. Place template on the ductwork of the HVAC system. Trace hole pattern and mark the four mounting holes on ductwork.
3. Cut out the traced hole opening on ductwork with tin snips.
4. Attach unit to air duct using the four self-tapping screws provided.

HOLE SAW INSTALLATION TEMPLATE

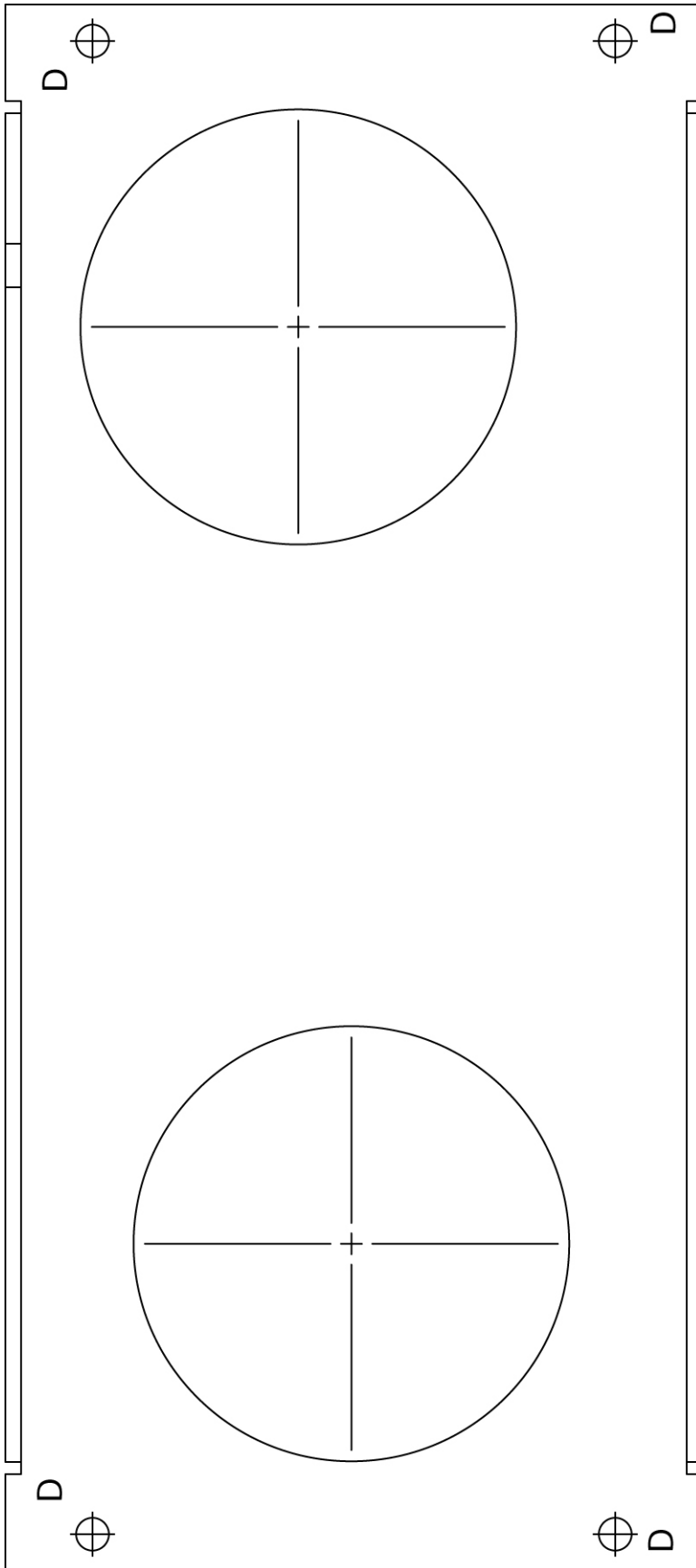

1. Place the template on the ductwork of the HVAC system. The unit should be mounted lengthwise on the duct.
2. Using a 2 ½” hole saw, drill holes at centers as indicated.
3. Mark the four mounting holes on ductwork. Attach the unit to ductwork using the four self-tapping sheet metal screws provided.

