



Boostsolar Photovoltaic Equipment Co., Ltd

BOOSTSOLAR BSLBIII

AUTOMATIC SOLAR MODULE LAMINATOR

USER'S GUIDE

(Please read it carefully before operating the Equipment)



***QINHUANGDAO BOOSTSOLAR PHOTOVOLTAIC EQUIPMENT
CO., LTD***



Content

CHAPTER 1 Summarize.....3
CHAPTER 2 Safety Precautions.....4
CHAPTER 3 Introduction of Equipment.....6
CHAPTER 4 Installation and Debugging.....10
4.1 Installation.....10
4.2 Debugging.....12
CHAPTER 5 Operation.....17
5.1 Instruction of Button Function.....17
5.2 Option of Control Mode.....21
5.3 Operation Method.....21
CHAPTER 6 The Common Failure and Solution.....26
CHAPTER 7 Equipment Maintenance.....28
7.1 Maintain and Daily Maintenance.....28
7.2 Replacement of Silicone Rubber Sheet.....29
7.3 Replacement of Teflon Fabric.....31
7.4 Replacement of Teflon Conveyor.....33
7.5 Replacement of Vacuum Valve Sealing Ring.....35
7.6 Replacement of ϕ 14 Sealing Strip.....37
7.7 Replacement of ϕ 6 Sealing Strip.....38
7.8 Adjustment of the Loading Board and Unloading Board.....38
7.9 Open the Safety Hook.....38
7.10 Replacement of O Shape Sealing Ring of Lower Vent Valve39
7.11 Replacement of Heater.....40
CHAPTER 8 Oil Heater Instructions.....41
8.1 Oil Heater Brief.....41
8.2 Usage.....42
8.3 Closedown Heating Station.....43
8.4 Caution.....43
8.5 Malfunction Estimation and Maintenance.....44
8.6 Replacement Method of Oil Heating Pipe.....45
CHAPTER 9 Emergency Measures For Equipment Power Failure.....46
9.1 Summary.....46
9.2The recommended Measures When Power Failure or Air Stopped.....46
9.3. Methods of manually remove modules.....47
9.4 To Remind.....48
CHAPTER 10 Regular Maintenance of Equipment.....48



Chapter 1 Summarize

1.1 The user's guide introduces some matters of Solar Module laminator which is heated by oil in details, including working theory, operation method, maintaining and repairing, familiar malfunctions and eliminating methods etc.

Automatic Solar Module Laminator is as the necessary equipment of solar module manufacturing, user should predominate all capabilities expertly and operation methods of laminator. This is an important aspect that improves the product quality and prolongs the using life of equipment.

User should read this guide carefully after purchasing Automatic Laminator and know well the operation methods before using the equipment.

1.2 Copyright of this user's guide belongs to Qinhuangdao Boostsolar Photovoltaic Equipment Co., ltd. Do not permit to transshipment, copy or distribute if not be admitted by the company.

1.3 Our company retain modification right , because of the inversion of the technique, the content of manual may have some change, please pardon and we will not inform in addition.

1.4 The charts showed in this user's guide are different with actual product by any possibility and only for your reference.

1.5 Product nameplate:

秦皇岛博硕光电设备有限公司		CE	
BOOSTSOLAR PHOTOVOLTAIC EQUIPMENT CO., LTD			
产品名称 Name	太阳能电池组件层压机 PHOTOVOLTAIC MODULE LAMINATOR		
型号 Model		极限真空 Limit vacuum	
出厂编号 P/N		电压 Voltage	
出厂日期 Date		装机容量 Power	
重量 Weight		气压 Air pressure	
层压面积 Effective area		工作温度 Temperature	
地址：中国·河北省秦皇岛市北戴河经济技术开发区 ADD: QINHUANGDAO HEBEI CHINA TEL: +086-0335-4289970			



博碩®

Boostsolar Photovoltaic Equipment Co., Ltd

Chapter 2 Safety Precautions

2.1 In order to arrive safely and avoid damaging during transportation , some warning marks are made on the over wrap before delivery:

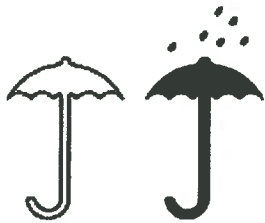

KEEP FROM MOIST

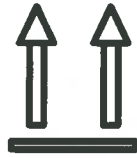

STOP INVERSION

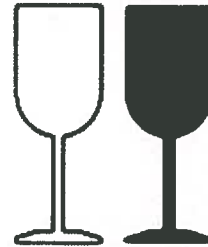

FRAGILE

2.2 Some warning marks are made on the dangerous parts of equipment:

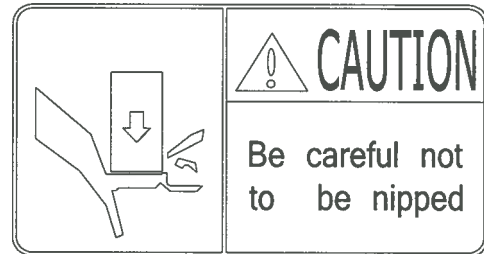

2.3 In order to make sure user's benefit, user should pay attention to the following questions during operation:

2.3.1 Operate the equipment strictly according to normal process.

2.3.2 Maintain laminator and replace electric parts are strictly prohibited when power isn't cut off.

2.3.3 Keep the electric control box dry and clear. No loading sundries.



博碩®

Boostsolar Photovoltaic Equipment Co., Ltd

2.3.4 The heating board and the control panel of laminator should avoid being doused and splattered by liquid during the operation process. Liquid can bring on short-circuit and influence on operation of the equipment.

2.3.5 Appointed man should take charge of operating the laminator. Especially when laminator is running, appointed man should be charge of closing the upper cover.

2.3.6 When the laminator is running, the heating plate (named working table) is with high temperature. Operator should be careful and avoid to be scalded.

2.3.7 When upper cover is closed, operator should not put his hand on the edge of lower chamber and avoid to be pressed mark by the upper cover.

2.3.8 Must cut off power supply when the laminator stops using with a long-time.

2.3.9 Operator should notice security guard of conveyor belt and do not wear gloves. It must be coiled if operator has long hair.

2.3.10 Do not to strike the surface of operation panel (Touch Screen) by something hard.

2.3.11 Prohibit strictly loosening all tie-in flanges and infusing or discharging oil artificially during operation of laminator. Avoid operators to be scalded by the high temperature oil.

2.3.12 Operators may stop operating the laminator by urgent pushbutton at all urgent circumstances.

Chapter 3 Introduction of Equipment

3.1 Equipment name: BOOSTSOLAR Automatic Solar Module laminator.



博碩®

Boostsolar Photovoltaic Equipment Co., Ltd

3.2 Unit Type: BSLXYOAC

E.G.:

BSLXYOAC

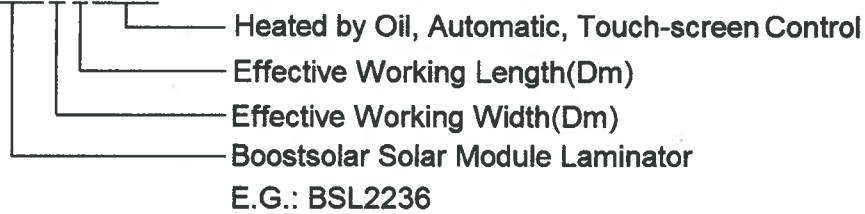

3.3 Function: It is used for laminating solar modules.

3.4 Size: Automatic laminators have different size according to different laminating size, including 1.6m×3.6m, 1.8m×3.6m, 2.2m×3.6m, 2.4m×3.6m, etc. We can manufacture according to user's requirement.

3.5 Operation mode: manual operation, semiautomatic operation and automatic operation.

3.6 Equipment Introduction and Configuration

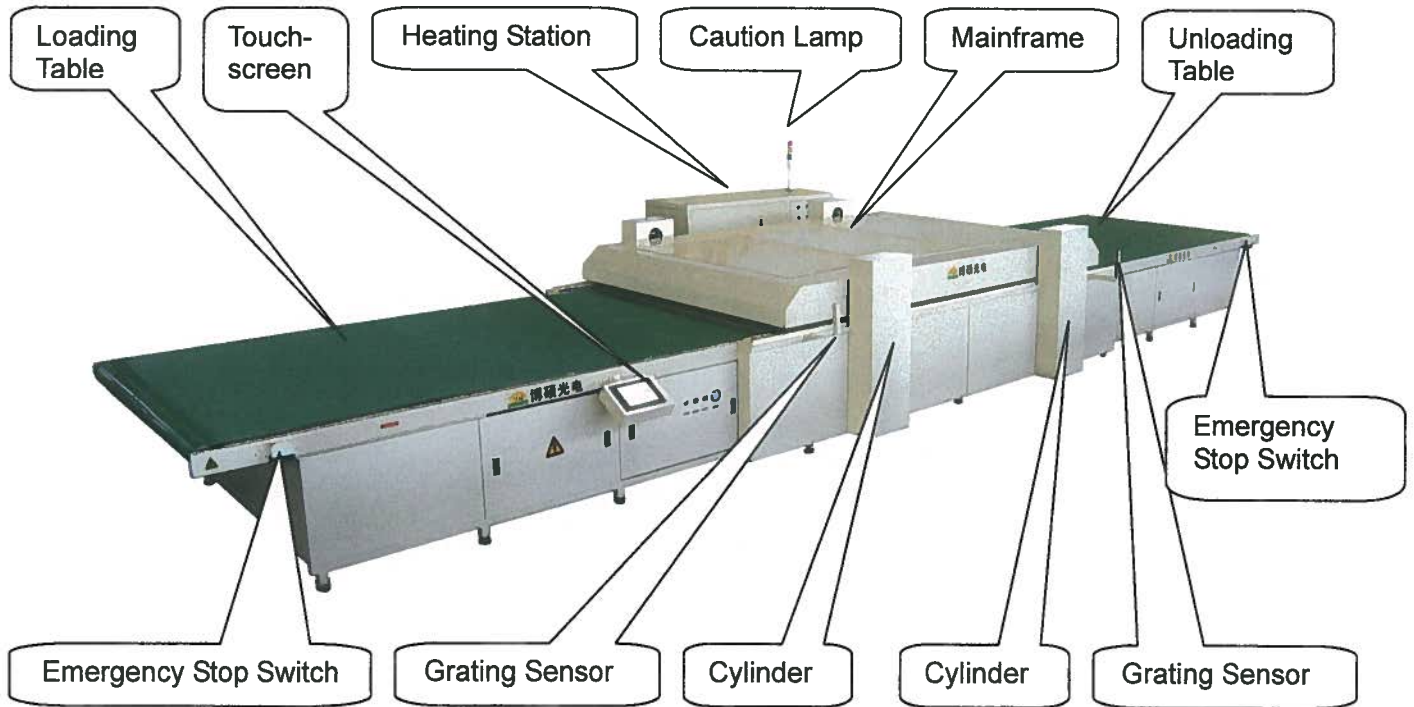



3.6.1 Heating Systems

Boostsolar automatic solar module laminator adopts the heating system heated by heating transfer oil. Work theory drawing of heating mode is shown as follows:

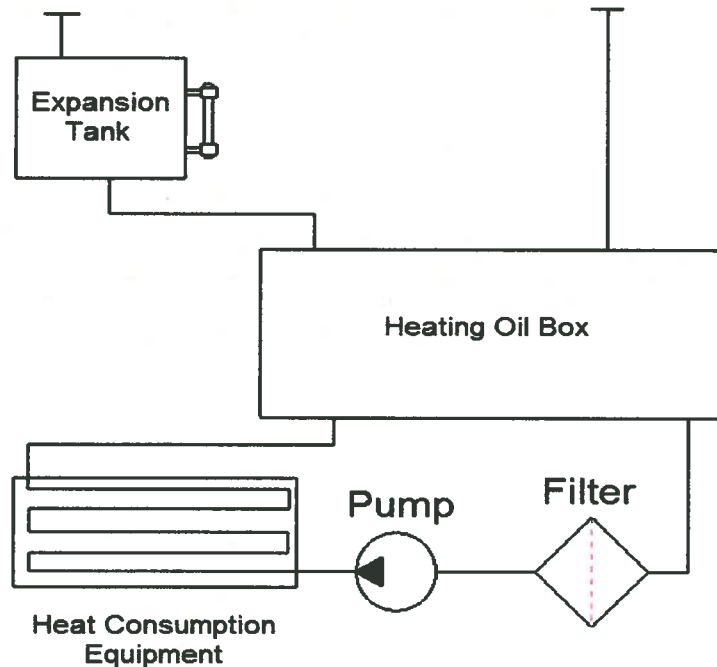

Heat transfer oil is transmitted to the Heat Consumption Equipment through hot oil pump by pipeline after Heat Carrier (heat transfer oil) is heated by electric heating tube in the Heating Oil Box. After the exchange of heat is completed, hot oil turns back to heating oil box and be heated again. This system carries out the continuous and circular heat supply.

The heated system of heat transfer oil adopts the intellectualized PID control technique of auto regulation and automatic save. That ensures the uniformity and stability of temperature during heating.

3.6.2 Vacuum System

Vacuum system adopts the vacuum valve system developed by ourselves. And strict standard of vacuum valve system during designing, producing, checking and accepting ensure that our equipment has well operating performance and laminating effectiveness. Working theory is as showed in the following figure:

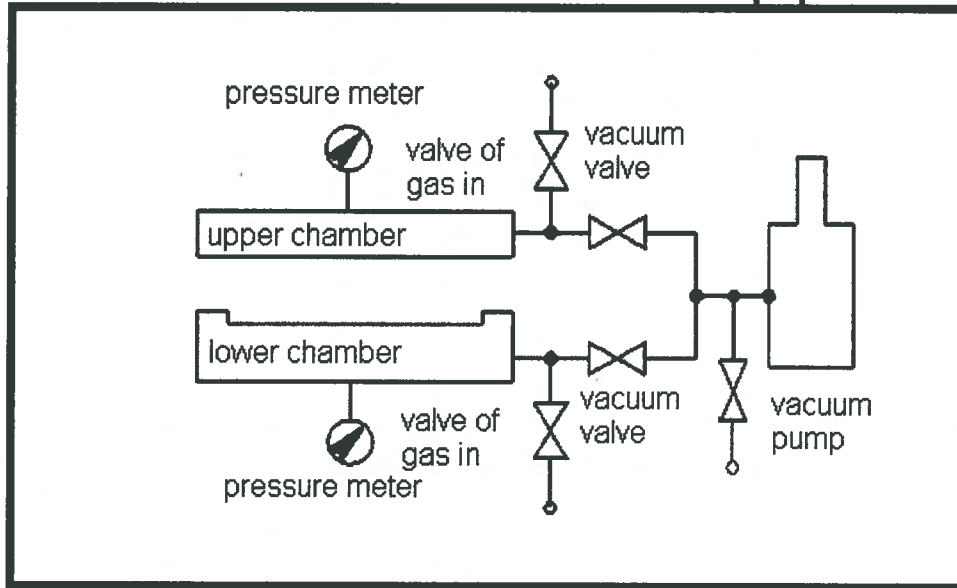

3.6.3 Framework of opening and closing cover

The opening and closing of the cover is drove by four double-acting cylinders. It is stable and reliable. Working Theory is shown as the following Figure:

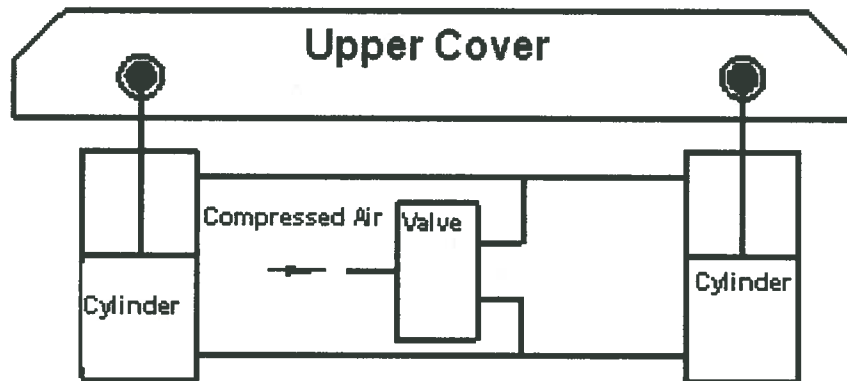

Inductive Switch of opening and closing Cover and inhibiting device of opening Cover are installed in the Cylinders. Keep balance when upper cover is opened in limit position.

3.6.4 System of loading and unloading Module

Automatic Solar Module Laminator is composed of Mainframe, Loading Table, and Unloading Table.



博碩®

Boostsolar Photovoltaic Equipment Co., Ltd

Module is loaded and unloaded by width Rubber on the Loading and unloading table. Mechanism is as shown in the following figure:

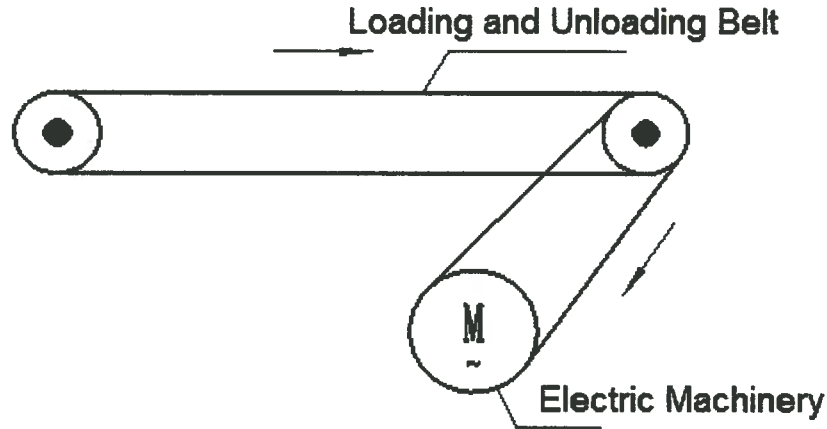

Conveying mechanism of mainframe is circular structure and adopts chain to drive fireproof fiberglass fabric as conveyor belt. Mechanism is as shown in the following figure:

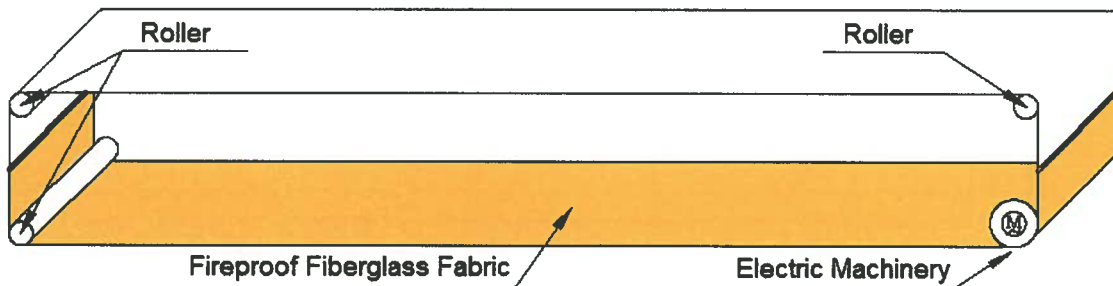

3.6.5 High-temperature conveyor belt cleaning device

Brush Cleaning Device is designed in order to prevent colloid paste on the High-temperature conveyor belt. It can clean colloid during production, and the production efficiency increases.

3.6.6 Manual Operating Mechanism as Power Supply is Shut off

When power supply of equipment is shut off abruptly for unpredictable suddenness, we design especially manual operating mechanism in order that operator may open upper cover and take out solar module in the laminator.

3.6.7 Main Safety and Alarm Device

It adopts Latch Hook of Machinery in order to ensure that Laminator can



博碩®

Boostsolar Photovoltaic Equipment Co., Ltd

be running in security. Latch Hook of Machinery after opening Cover: First, prevent upper cover falling because of steam leakage during accidental situation. Second, it can limit space automatically when opening cover in space

We design some alarm devices in the heater including the device which power supply will shut off and alarm as temperature is too high and the device which equipment stops running when heat transfer oil position is too low.

Mainframe installs raster safeguard device, safeguard system which unloading module is finished and three colors indicator. Green light is twinkling when equipment is running in gear. Red light is twinkling when opening cover, closed cover, loading module, unloading module and go ahead. Yellow light is twinkling when equipment is automatically running and is in the initial position.

Emergency stop pushbutton is installed on the Equipment to ensure operator may stop running equipment at any emergency circs.

Chapter 4 Installation and Debugging

4.1 Installation

4.1.1 Security matters during transportation

4.1.1.1 Operation according to packaging marks during transportation, prohibit operating brutally.

4.1.1.2 Loading & Unloading table and Heating Station can be hoisting by Lifting Straps.

4.1.1.3 There are four Lifting Hooks in the specific location of Mainframe, it can be lifted by $\phi 14$ Hoisting Cable.

4.1.2 Installation Site

4.1.2.1 Automatic Laminator should be operated indoors.

4.1.2.2 Operating environment must eliminate shade and wet, and ensure without wind.



博碩®

Boostsolar Photovoltaic Equipment Co., Ltd

4.1.2.3 Spatial height is not less than 4 meter.

4.1.2.4 The distance between two equipments is not less than 4 meter. There should be enough space as transportation, remove and maintain Equipment.

4.1.3 Operating condition

4.1.3.1 The Ground should be even for placing Laminator.

4.1.3.2 Power Supply: 380V Three Phases, AC

4.1.3.3 Compressed Air Supply: 0.8~1MPa

4.1.4 Installation Process

4.1.4.1 Check every part and electro-control parts of the laminator whether to be destroyed before installation.

4.1.4.2 Some parts are loose due to Transportation. Check carefully turnbuckle in the pivotal part for any lose and loose before installation. Once found, rectify duly.

4.1.4.3 After unpacking, install the leveling feet of equipment at each corner above all. Adjust the machine to the horizontal level in order to make each foot of the laminator receive strength evenly.

4.1.4.4 Connect air compressor with laminator's air channel pipeline. Pipeline of air compressor is PU Air Duct which size is $\phi 16$.

4.1.4.5 Connect Laminator and Vacuum Pump with $\phi 50$ PVC Intensifier Tubes.

4.1.4.6 Connect the total power supply of laminator to the switchboard box.

4.1.4.7 Connect the laminator's switchboard box with vacuum pump's power. Connection numbers are No.14, No.15 and No.16 (Pay attention to the three-phase order in order to ensure vacuum pump's electric machinery no reversal. Operator may check the turning direction by spot-using the vacuum pump.)

4.1.4.8 Ensure the direction of main electoral machine and electoral machine of Loading & Unloading module Table to be consistent with acquiescence direction of equipment.

4.1.4.9 Connect the total power line of heater. Connect the pipeline of



博碩®

Boostsolar Photovoltaic Equipment Co., Ltd

inflow and outflow oil and control wire between the heater and laminator.

4.1.4.10 Connect automatic Loading & Unloading module system to mainframe and ensure planes of Loading & Unloading Table to be flush with laminating Table.

4.1.4.11 All connection should ensure that Air Pipes is connected tightly. Lock the pipeline hoop in order to avoid leaking on operation.

4.2 Debugging

4.2.1 Please pay attention to the following questions during debugging:

4.2.1.1 Laminator is running normally without exceptional noise.

4.2.1.2 Vacuum system is natural without leaking air.

4.2.1.3 Heating function is natural.

4.2.1.4 All Pushbuttons and indicator Lights can work naturally and effectively.

4.2.1.5 Equipment can react and run accurately according to the item which operators click on the touch screen.

4.2.2 Debugging Process

4.2.2.1 Mainframe is core insulation of equipment. Whether performance and parameter of mainframe is natural or not, that will affect directly producing process. Those items which need be debugged including the following Points: Check the operation of pushbutton, switch, meter and indicator light whether can be work normally or not; Check the action of Vacuumized Equipment, Pneumatic Equipment and Heating Equipment whether can work normally or not.

4.2.2.2 Push all air break switches to 'ON' position. And then turn the key switch of equipment on the control plate of mainframe and turn on power supply. At the moment indicator of touch screen should become bright.



博碩®

Boostsolar Photovoltaic Equipment Co., Ltd

4.2.2.3 Interface which touch screen logs on:



In this interface, User may enter into Manual Interface, Automatic Interface, Company Introduction, Operation Explanation, and Attentions Interface by inputting Key F on the right of Touch-screen. User can also operate it by Tools Menu directly.

First User should read operation explanation and attentions in order to master operation regulation of laminator.

4.2.2.4 Enter into manual interface by pressing Key F1 or by clicking 'Tool' menu.

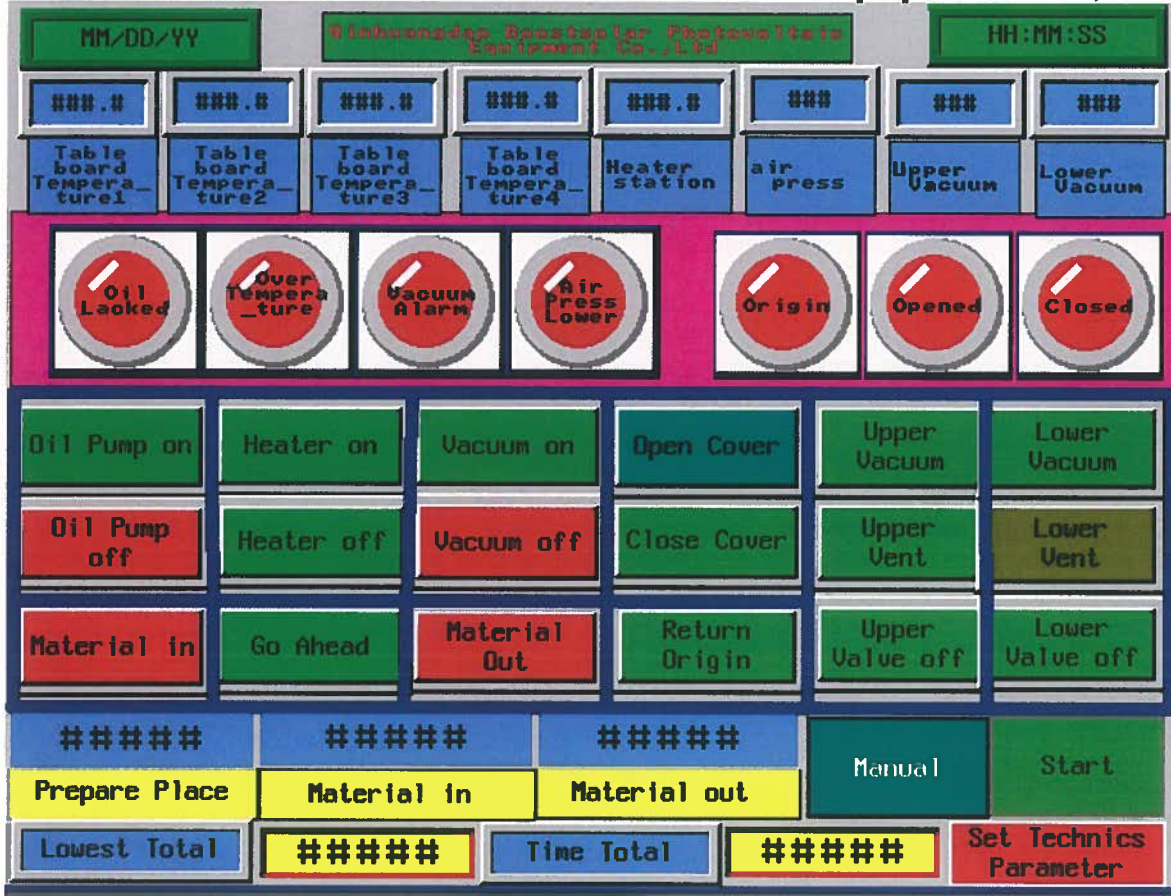

Operator may press the **Vacuum on** pushbutton and run vacuum pump. (Notice vacuum pump is positive rotation or reversion.) Then pushbutton of Vacuum Pump On becomes bright.



Press the **Upper Vacuum** pushbutton and this pushbutton becomes bright.



Press the **Lower Vent** pushbutton and this pushbutton becomes bright. The final indication of meter displaying vacuum degree of upper chamber is vacuum negative state and the final indication of meter displaying vacuum degree of lower **Lower Vacuum** nature state.



Press the **Lower Vacuum** pushbutton and this pushbutton becomes green. Then lower chamber begins to enter into vacuum state and the final indication of meter displaying vacuum degree of lower chamber is vacuum negative state. Vacuum degree will be displayed on the touch screen. (Note: Pushbutton of lower vacuum is ineffective as opening cover in the manual state and is





博碩®

Boostsolar Photovoltaic Equipment Co., Ltd

effective as closed cover is finished.)

Press the  pushbutton and this pushbutton becomes bright. Then upper chamber begin to enter into vent state and the final indication of meter displaying vacuum degree of upper chamber is nature state.

Press the  pushbutton and the  pushbutton. Press the  pushbutton after the indication of meter of upper chamber and lower chamber reach nature state. Then buzzer of opening cover makes a buzzing sound and laminator's cover is opening. Observe the action of opening cover whether or not is placidity and credibility.

Note: Pushbutton of upper vacuum and pushbutton of upper vent is interlocked. Pushbutton of upper vent will be closed automatically when pressing the pushbutton of upper vacuum. Contrarily pushbutton of upper vacuum will be closed automatically when pressing the pushbutton of upper vent. When operator need to close pushbuttons of upper vacuum and upper vent, operator may press the pushbutton of 'upper air channel stop'.

Pushbutton of lower vacuum and pushbutton of lower vent is also interlocked. Pushbutton of lower vent will be closed automatically when pressing the pushbutton of lower vacuum. Contrarily pushbutton of lower vacuum will be closed automatically when pressing the pushbutton of lower vent. When operator need close pushbuttons of lower vacuum and lower vent, operator may press the pushbutton of 'lower air channel stop'.

After opening cover is finished, the  indicator becomes bright. (Note: Loading modules are not available as opening cover is not finished.)

If the position of pole stops is not initial position of user need, operator should press the 'return' pushbutton until equipment reaches the accurate initial position.

4.2.2.5 Set up Parameters in interface of **technological parameters** in the state that closed cover is finished and initial position.

Then press the  pushbutton in the manual interface

and enter into automatic state after confirm 'steps setting parameter' to be inerrable. Then press ██████ pushbutton, equipment begins to enter into automatically working state. The interface of automatic state is as showed in the following figure:

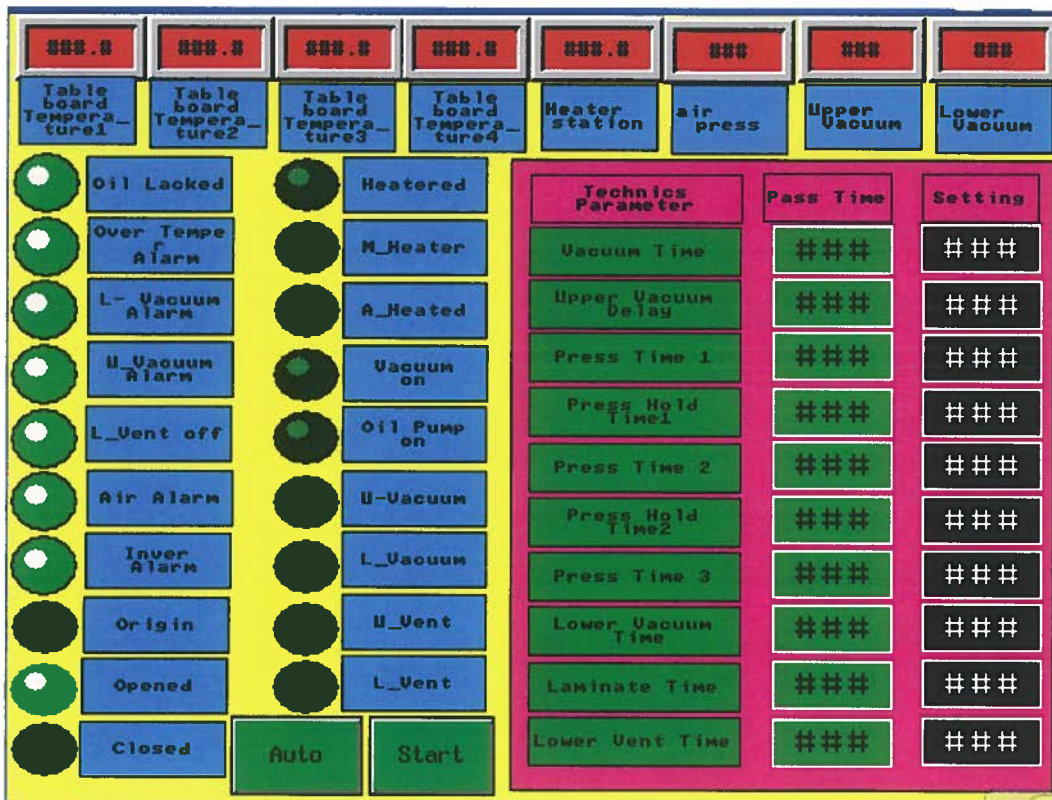

Process line is as following: Put modules on conveyor belt and modules are conveyed automatically into laminator. When all modules are conveyed into accurate position, conveyor belt stops and cover closed automatically. After closing upper cover is finished, laminator enters into automatic laminating state. After laminating process is finished, laminator opens upper cover. After opening upper cover is finished, modules are conveyed automatically out from laminator. When modules are conveyed to accurate position, operator takes away modules. Then conveyor belt of mainframe run to initial position. If conveyor belt of mainframe don't run to accurate initial position, operator may press 'Return' pushbutton until conveyor belt locate



博碩®

Boostsolar Photovoltaic Equipment Co., Ltd

accurate position. In this way laminator may be ready for next operation.

Pay attention to whether position is accurate during the process of loading & unloading modules. Please contact engineer to debug it if there is any questions.

Debugging is finished if the above operation process is normal and without abnormal situation.

Chapter 5 Operation

5.1 Instruction of Button Function

Emergency Stop Button: Each has one in loading bay, unloading bay and operation table, used for emergency stop running of the whole equipment. Emergency stop button on heating panel only used to stop heating.

Material-In Button: Can drive the material-in board directly, at the corner of the loading bay.

Material-Out Button: Can drive the material-out board directly, at the corner of the unloading bay.

Power Supply Button: Power key switch, used for supply power to the equipment..

Touch-Screen Startup Button: Switch to Auto interface, and set all parameters correct, press the button begin the process automatically.

Touch Screen Material-In Button: Switch to manual interface, press this button to convey the material to the laminating place.

Touch Screen Go-Ahead Button: Switch to manual interface, press this button to convey the material move forward some distance, when the button up, the movement stop.

Touch Screen Material-Out Button: Switch to manual interface, press this button to convey the material out of the laminating board and reach the unloading bay, stop at the scheduled location.

Touch Screen Return Original Button: switch to manual interface,

press this button which can run the teflon fabric that used to convey the material return to original location. Be sure the teflon fabric is on the laminating board at this moment, otherwise press the button once again.

The above Buttons only effective on the basis of the upper cover closed.

Touch Screen: Manual states: use it to operate the equipment in manual mode; Automatic states: use it to monitor the equipment. Show under chamber vacuum status, air pressure, vacuum time, pressure dwell, laminating time, table board temperature and such parameters.

The technology parameters setting interface as follows:

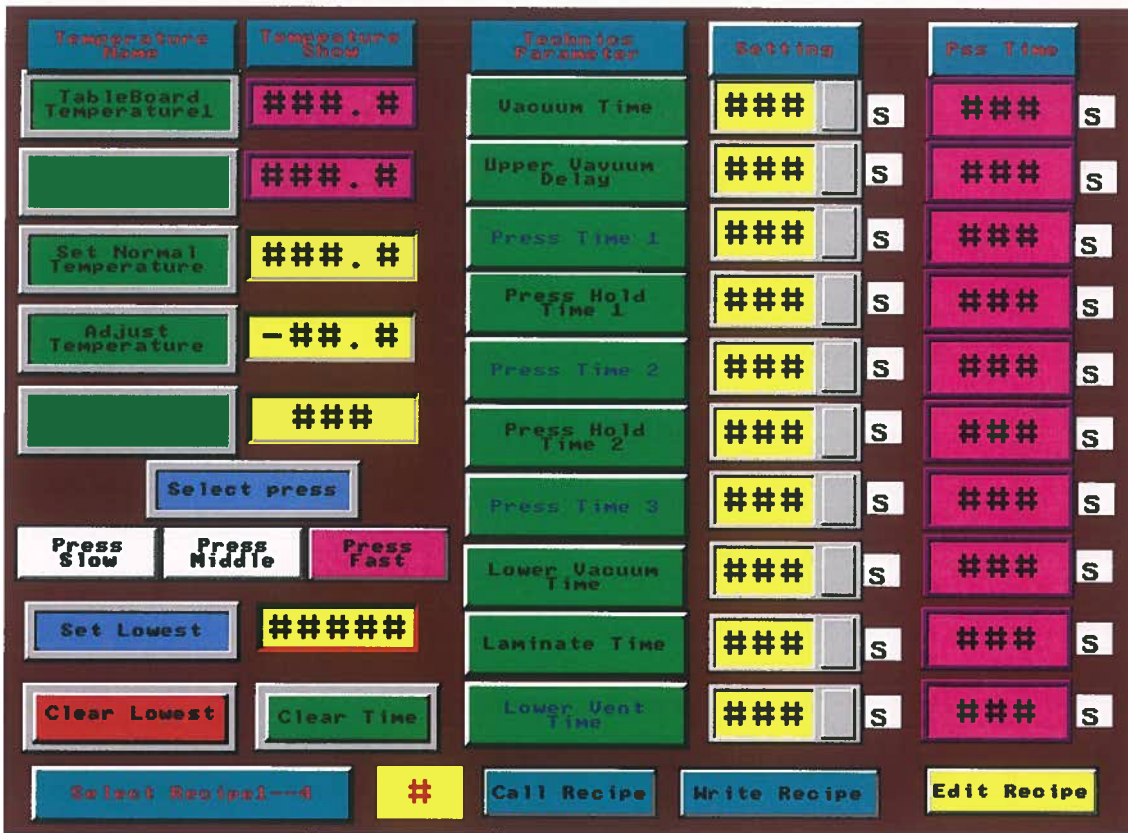

In this interface you can set evacuation time, treble pressurizing time, laminating time and lower vent time, even can set the normal temperature parameters and see the value of the table board temperature.

Function Instruction



博碩®

Boostsolar Photovoltaic Equipment Co., Ltd

Upper Vacuum Delay: When the equipment running automatically, after the under chamber vacuumize for a few seconds, upper chamber start to vacuumize.

Lower Vacuum Time: The time to start laminating tills the time the under chamber vacuumize before open cover when the equipment running automatically, unit: second

Lower Vent Time: The lower vent time after laminating before open cover when the equipment running automatically, unit: second.

Press Delay: The delay time from the last press to the second press.

Step parameter setting interface as follows:

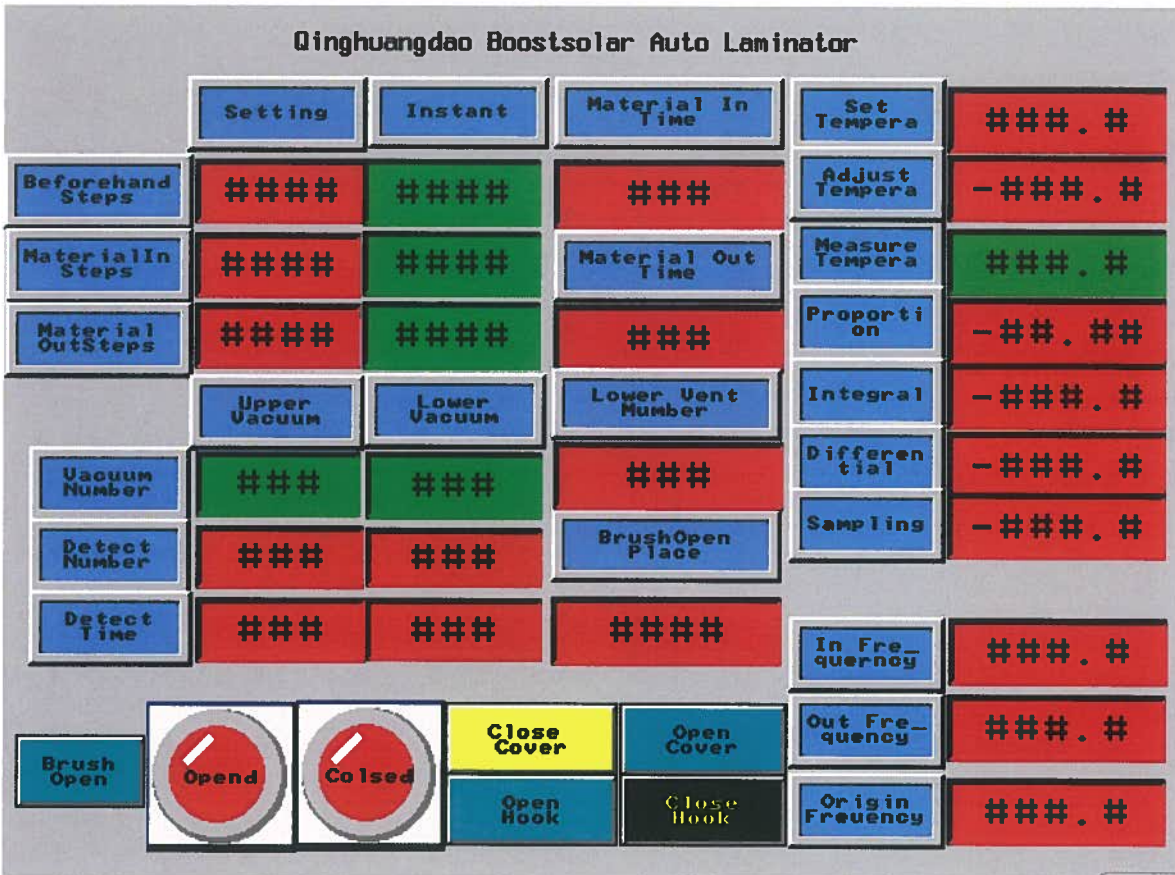

In this interface you can set material-in pre-travel, material-in steps and material-out step.

Partial Function Instruction:

Beforehand Steps: The running steps of mainframe from original place to material-in start.



博碩®

Boostsolar Photovoltaic Equipment Co., Ltd

Material-In Steps: Steps of loading bay and mainframe running together.

Material-Out Steps: Steps of unloading bay and mainframe running together.

Option of Air charge speed

Air Charge Slow: Press this button, the air charge speed of upper chamber is slow rate.

Air Charge Medium: Press this button, the air charge speed of upper chamber is medium rate.

Air Charge Fast: Press this button, the air charge speed of upper chamber is fast rate.

The default value of system is medium rate when the equipment startup, users can make its own decisions in accordance with the process requirements.

Position of Brush Roller Startup: This value decides the length of Teflon fabric which brush roller automatic cleaning.

Temperature setting and interface display as follows:

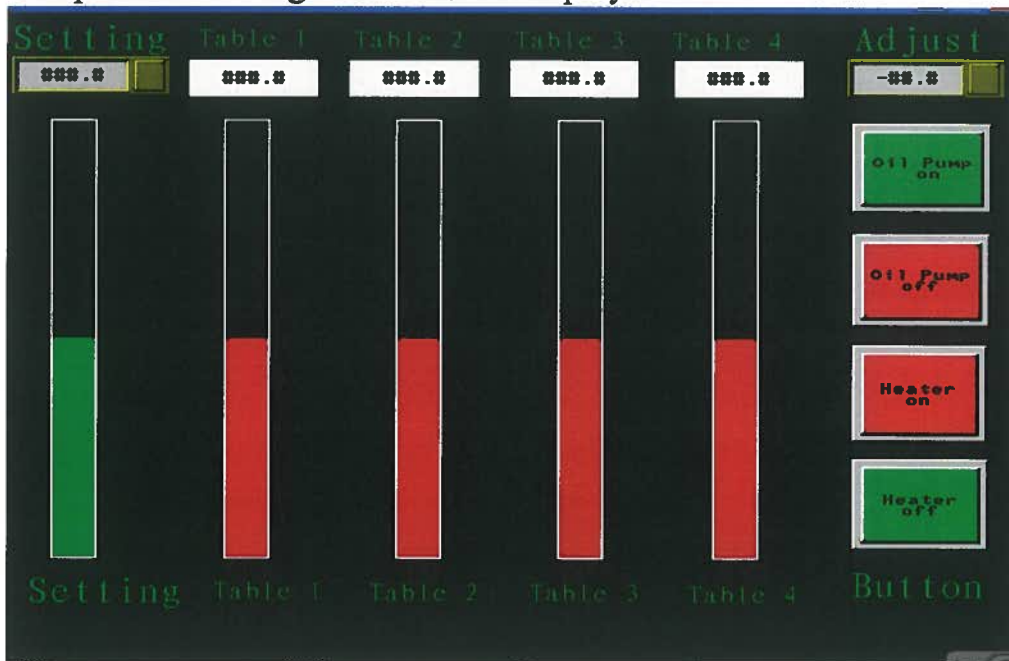

In this interface, you can set up process temperature and interface display, also can adjust table temperature and temperature difference of display by adjusted value.



博碩®

Boostsolar Photovoltaic Equipment Co., Ltd

Note: Non-professional staff is strictly prohibited to amend the equipment parameters such as process time, steps and temperature setting and so on.

5.2 Option of Control Mode:

The equipment has three control mode for users to option, Automatic Control, Semi-Automatic control and Manual control mode. The user only needs to press Automatic/Manual button to the corresponding location according to his need. The difference between the mode of semi-automatic and automatic is: semi-automatic mode need to put material and close cover manually, and then start laminating process, while the automatic mode is that all of the processes are operated automatically.

Note: Under automatic mode, press automatic button, then press startup button to running the equipment, but the semi-automatic mode only need to waiting for the cover closed, press automatic button, the processes will go on running directly.

5.3 Operation Method

5.3.1 Startup and Warm-up

5.3.1.1 Before startup be sure all the pipelines of laminator has a good connection. Connecting power master switch which in distributor box of the equipment and heating switch.

5.3.1.2 Startup air compressor, connecting the compressed air.

5.3.1.3 Insert the key of Key Switch to keyhole of Power Supply, thus to provide power for laminator. At this time the touch-screen power indicator light is lightened.

5.3.1.4 Setting the touch screen as manual interface.

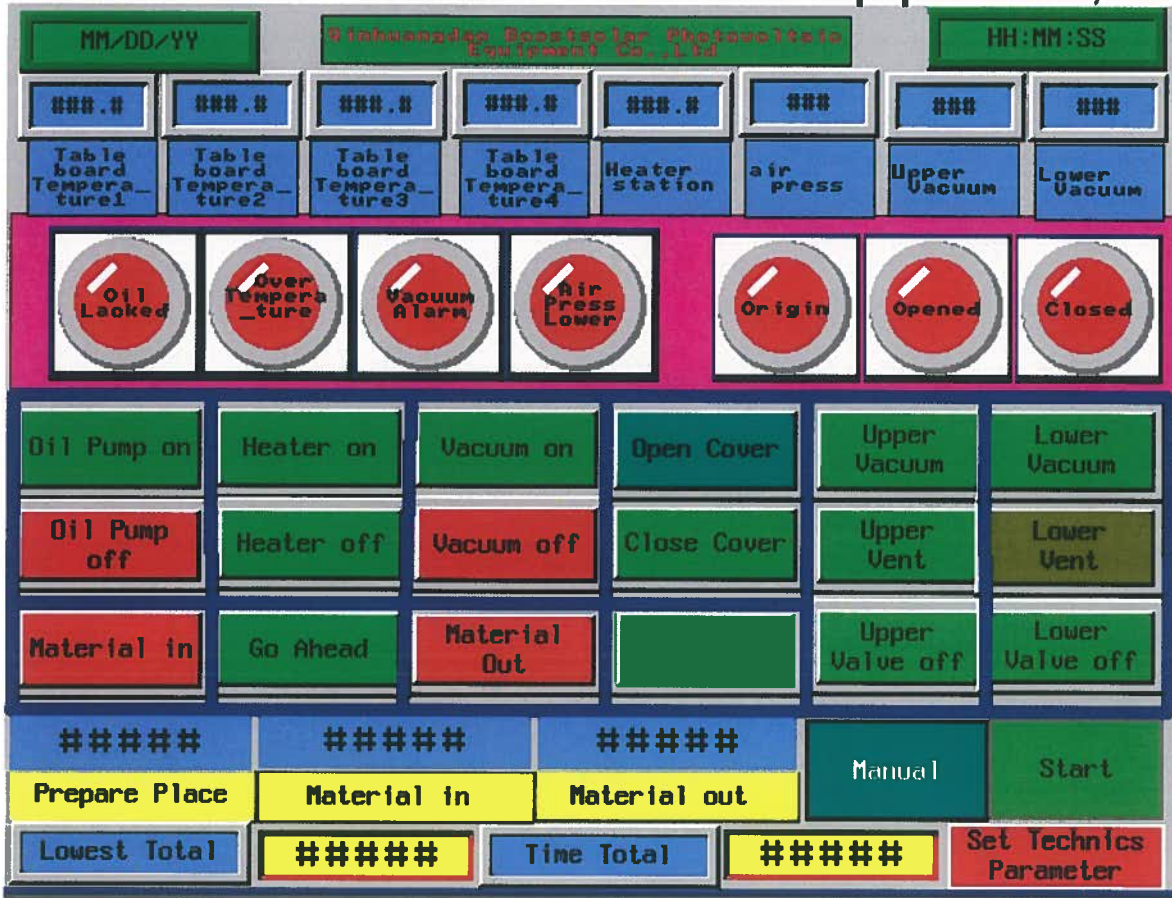

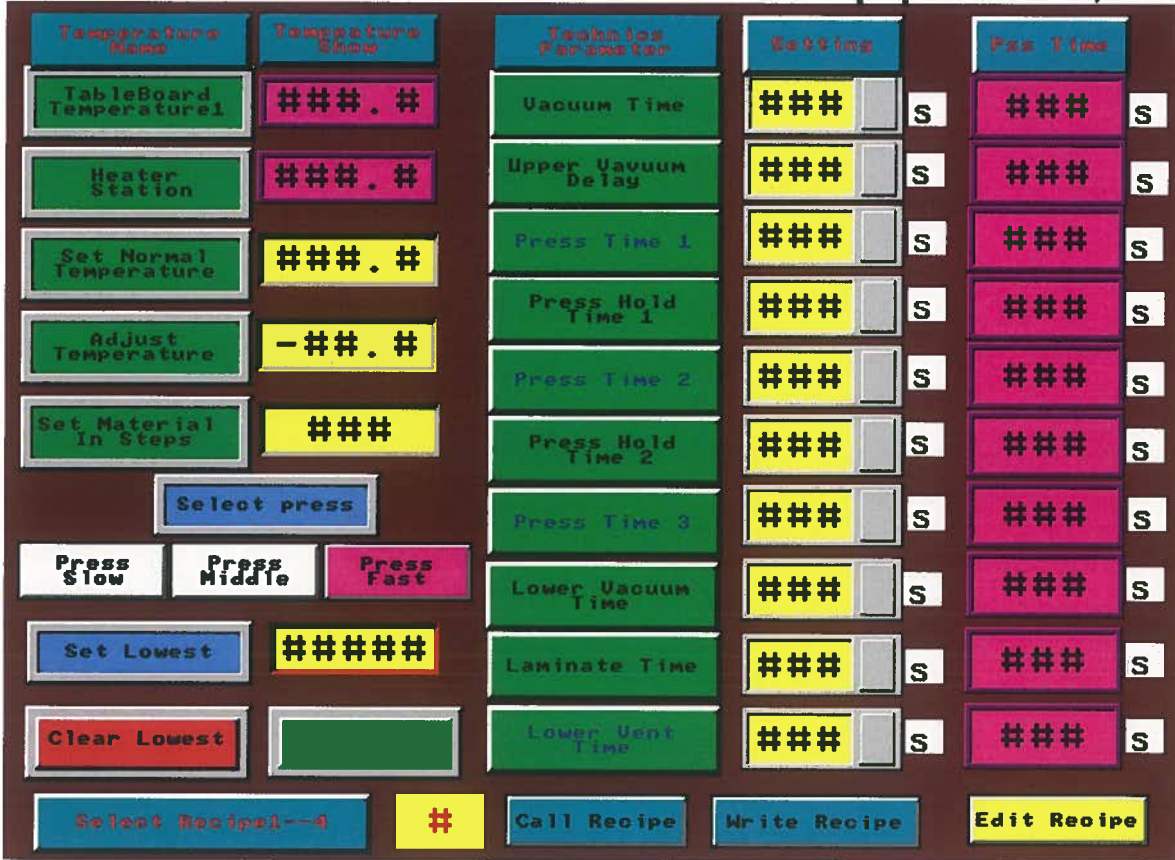

5.3.1.5 Check Auto/Manual button under the manual interface of the touch-screen: ensure that is under “Manual” control mode. Press the button **Oil Pump on**, **Heater on** and **Vacuum on** one by one, lightened in turn.

5.3.1.6 Through the Tools menu enter into the process parameters interface.



5.3.2.1 Setting the needed parameters.

5.3.2.2 Switch to manual mode interface, press the button  and , the button indicator light will be lightened in turn. The upper chamber and lower chamber come into vacuum status.

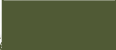
5.3.2.3 When the heating temperature reach the setting value and keep stable, press  wait for the completion of lower chamber vent.

5.3.2.4 Press  button, till  indicator lightened which means the upper cover opened.

5.3.3 Manual laminating process

5.3.3.1 First of all, place the expected laminating modules on the material-in board (loader).

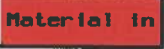

5.3.3.2 Press the **Material-In** button on the manual mode interface of touch-screen, or press  on manual operation mode interface, till the completion of material-in. (At this time should ensure the vacuum pump is turned on, cover opened indicator is lightened.)







5.3.3.3 Press  button on touch-screen manual mode interface,

till the upper cover totally closed, at this time  indicator is lighten.

5.3.3.4 Press Lower Vacuum button, 20 seconds later, Press  button, then both upper chamber and lower chamber are come into vacuum status. At this time, the indicator of Lower Vacuum and Upper Vacuum are light.



5.3.3.5 When reach the required vacuum time, press the button of  beginning of the implementation of certain time pressure to the modules. When the pressure time over press  button, stoppe upper chamber vent, start laminating.

5.3.3.6 When the laminating process over, press  button, then press  button, waiting for both chambers complete the corresponding operation.

5.3.3.7 Press  button, till the upper cover totally opened.  Indicator lightened.

5.3.3.8 Press the Material-Out button on touch-screen manual interface, or press  button on manual control mode, the mainframe conveyor and unloading bay running together, till complete the material-out operation. The mainframe conveyor will back to original place. (Note: Material out protection is effective at this time)

5.3.3.9 Place the expected laminating modules on the material-in board (loader) for next cycle operation.



5.3.4 Semi-Automatic Laminating Processing
After place the expected laminating modules on the material-in board (loader), press  button on manual control mode interface, when the  laminating modules conveyed to the laminating place, press  button, till the cover totally closed. Then press the automatic button, follow-up process will complete automatically.

5.3.5 Automatic Laminating processing



博碩®

Boostsolar Photovoltaic Equipment Co., Ltd

Ensure the setting parameters are all correct, after place the expected laminating modules on the material-in board (loader), press  button, and then press  button, the whole working process will complete automatically without any human intervention or operation during the whole course.

Some attention should be given during the automatic operation:

5.3.5.1 Before operation, ensure the equipments on original place. (The mainframe teflon conveyor is under the table-board of mainframe)

5.3.5.2 If you switch the automatic button to manual button during the automatic operation, the program will terminate all current operations automatically.

5.3.5.3 During the automatic operation, be sure the modules are in correct place. If the positions of material-in and material-out are not accurate, switch the  button to manual button to correct it.





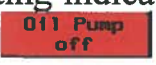

Note: Equipment should trial run 2-3 times before automatic operation every time to ensure the equipment operating normally.

5.3.6 Shutdown

5.3.6.1 Adjust the equipment operation as manual mode.

5.3.6.2 Keep the upper cover in open state, press  button in manual mode interface, at this point the heating indicator on the touch-screen turn off. 5 minutes later after heating, press  button, closedown the hot oil pump. At this time the oil pump indicator on the touch –screen turn off.

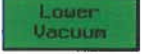
5.3.6.3 Waiting for the temperature of equipment table board dropped to below 80 °C.

5.3.6.4 Press  button, till the cover totally closed. Press  button, after upper chamber vacuumize for 2-3 minutes, press  button, both the upper chamber and lower chamber are come into vacuum state, at this time the  and  indicator turn on. Both of upper chamber and lower chamber reached vacuum state, press  button and  button.

5.3.6.5 Press , rotating the “POWER” key of power switch to “OFF” position, the power supply of the equipment turnoff.



博碩®

Boostsolar Photovoltaic Equipment Co., Ltd

Note: To ensure the air intake course of the vacuum pump pipeline completed, shut down the power supply after vacuum pump shut down 5-10 seconds.

Chapter 6 The Common Failure and Solution

No	Failure Phenomenon	Conceivable cause	Solution
1	When upper cover closed, upper chamber and lower chamber cannot vacuumize	Vacuum pump doesn't run	Make vacuum pump running normally
		The running direction is differ from the arrow which marked on the vacuum pump (Reverse)	Adjust the three-phase order of connection and make the running direction of vacuum pump consistent with arrowhead direction.
		The pressure of compressed air abnormal.	Adjustment the compressed air pressure
		Switch for open/close cover doesn't work normally.	Adjust or replace switch
2	Cover closed, the lower chamber can vacuumize while the lower chamber can not	Upper chamber pipeline air leakage	Find the air leak position and repair it
		Upper chamber vacuum electromagnetic valve can not startup	Adjust pressure of compressed air to meet requirement or replace it.
		Upper vent valve loosen or damage	Replace vent valve
3	Cover opened, the upper chamber cannot vacuumize.	Upper chamber pipeline air leakage	Find the air leak position repair it
		Upper chamber vacuum electromagnetic valve can not startup	Adjust pressure of compressed air or replace it.
		Upper vent valve loosen or damaged	Replace vent valve
		Rubber sheet damaged	Replace rubber sheet
		Screws to press slat frame doesn't screwed tightly.	Screw up screws tightly
		Upper chamber vacuum valve working abnormal	Adjust compressed air pressure or replace vacuum valve
4	The upper chamber can not vent.	Upper chamber air vent electromagnetic valve cannot startup	Check the power line or replace the electromagnetic valve
		Upper chamber vacuum valve loosen	Repair or replace it
5	Upper chamber can vent air, but the pointer of vacuum gauge can not return to zero	Vacuum gauge damaged	Replace it
		A fast knot in the vacuum connecting tube to the vacuum gauge	Straighten the connecting tube
		Upper chamber vacuum valve loosen	Repair or replace it
6	Lower chamber cannot vent air	Lower chamber air vent electromagnetic valve damaged and cannot startup	Replace it

		Movement of lower chamber air valve working abnormal	Repair or replace it
		Lower chamber vacuum valve loosen	Replace it
7	Lower chamber can vent air, but the pointer of vacuum gauge cannot return to zero	Lower chamber vacuum valve loosen	Adjust lower chamber vacuum valve
8	Both upper chamber and lower chamber are on limit vacuum situation, but when upper chamber is venting, lower chamber reduce vacuum degree at same time.	Rubber sheet damaged	Replace silicone rubber sheet
		Lower chamber vacuum valve loosen	Adjust lower chamber vacuum valve
9	Vacuum degree is not high	Upper cover sealing ring connecting spring off.	Reconnect it well
		Vacuum pump oil has too many impurities.	Replace vacuum pump oil
		Lower chamber vacuum valve leakage	Replace or repair it
		The fixed screws of vacuum pump joint loosen	Tighten the screws
		The vacuum pump belt is too lax	Adjust the belt tightly
10	The upper cover cannot be opened	The pressure of air compressor is abnormal	Adjust the pressure
		The connecting pipeline of cylinder leakage	Check the pipeline, troubleshooting
		Electromagnetic valve damaged	Replace it
		Lower chamber under vacuum situation	Vent air to lower chamber
11	Procedures chaos under auto-run state	PLC connecting line loosen or there is something wrong with procedures	Tighten the fix-line screws of PLC or reset the procedures
12	Vacuum lower on laminating state	Silicone rubber sheet damaged	Replace silicone rubber sheet
		Upper chamber vacuum valve loosen , rubber sheet screw loosen	Repair or replace it, tighten crews
		Lower chamber vacuum valve air leakage	Replace or repair it.
13	Vacuum degree is lower when lower chamber vacuumize	Sealing strip of upper cover opened	Repair or replace it
		Electromagnetic valve joint loosen	Unload the joint then tighten it with 704 glue
		Vacuum pump oil too low	Add vacuum pump oil
		The vacuum pump belt is too lax	Adjust the belt degree of tightness
		Fastness screw of vacuum pump elbow looses.	Tighten the screws
		Lower chamber vacuum valve sealing ring damaged	Replace the sealing ring
		Vacuum gauge damaged	Replace vacuum gauge

		The connecting pipeline which connected to vacuum pump and laminator air leakage	Check the connecting pipeline
		Electromagnetic valve damaged	Replace it
		Power voltage abnormal	Check power voltage
14	Material-in cannot carry out under Auto-mode	Not in original place	Return to original place manually
		Upper cover not opened completed	Open the upper cover manually
15	Material out can not carry out under Auto-mode	Material out protection photo electricity switch was sheltered	Remove the shelter
		Upper cover not closed completed	Adjust or replace the open covered switch

Note: Above failure phenomenons are only the most common ones. If there has other problems which cannot solve by yourself, do not hesitate to connect with us.

Chapter 7 Equipment Maintenance

In the course of everyday use, improper use or not carry out normal maintenance work may affect the actual performance of laminator and reduce its service life. Therefore, to do maintenance work well is crucial.

7.1 Maintain and Daily maintenance

7.1.1 Equipments cannot be operated in dark and humid environment.

7.1.2 To check oil of the vacuum pump everyday to maintain a normal level.

7.1.3 Replace vacuum pump oil two times per month drastically, cleaning the vacuum pump every four months.

7.1.4 Carry out regular inspection to the rubber sealing strip, repair or replace it timely if it is loosened or damaged.

7.1.5 Every time after using the equipment, clean-up the sundries on the surface timely, keep the equipment clean.

7.1.6 Besides the above points, in the process of daily use, equipments should be used according to normal operating procedures strictly.

7.1.7 In order to maintain the good performance of the machine as well as to extend the using life, it is necessary to do some normal check to the

equipment after a long time use.

7.1.8 To check the brush roller wear situation after using for one month. Through adjust the position of fixation bolt of the brush roller cylinder to get appropriate pressure.

7.1.9 When the machine do not use for a long time, cut off the power supply, covered by dustproof & damp proof material, placed in dry and dust-free environment and guard against sunlight and rain.

7.2 Replacement of Silicone Rubber Sheet

7.2.1 Press debug button on startup interface, enter password 51072100, and then enter into the debugging interface. Press <Open Hook> button to open the security lock, and then press <Open Cover> to lift the cover to the highest position which should be 300mm above the board.

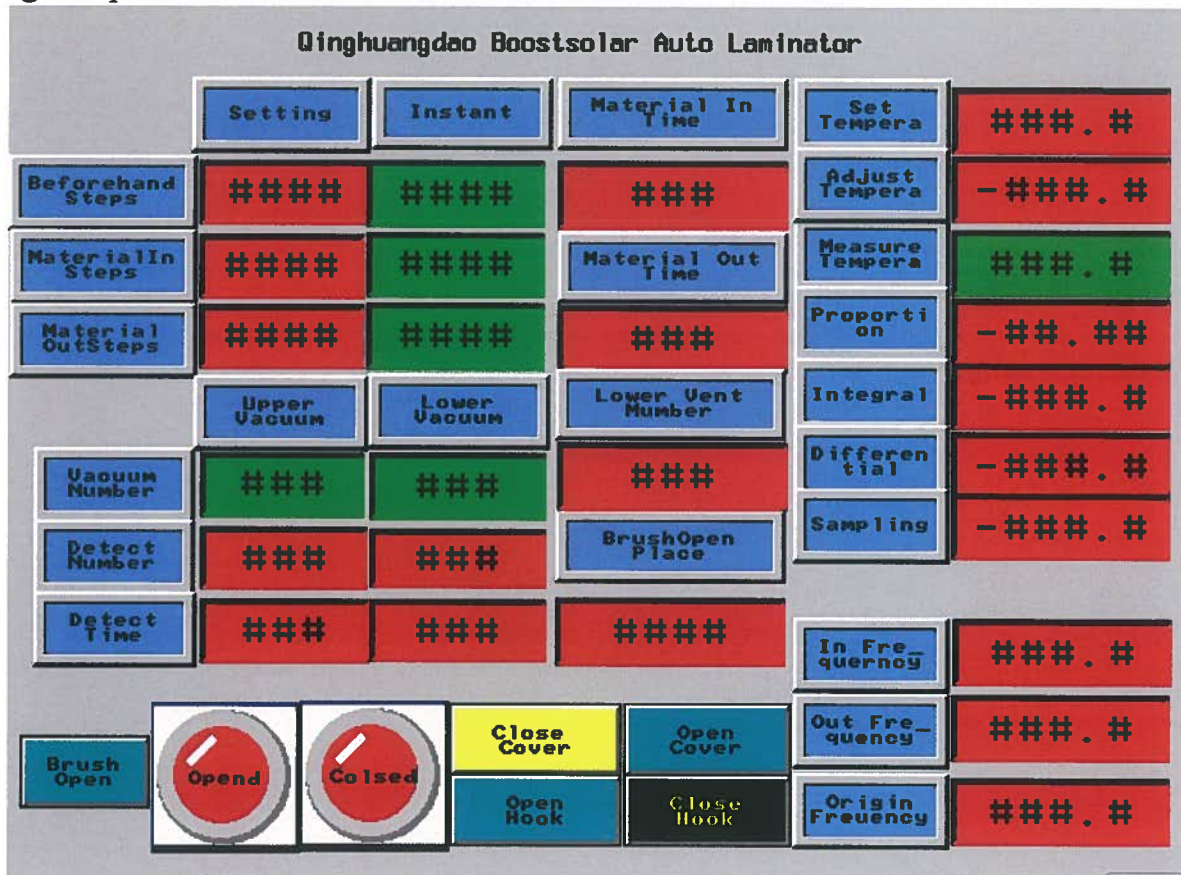

7.2.2 Beside the protection frame of four open cover cylinders, each with a upper cover draw rod, pull out the rod about 100mm hang on the pothook near the cylinder protection frame is ok.



博碩®

Boostsolar Photovoltaic Equipment Co., Ltd



7.2.3 Press <Close Cover> on touch-screen to close upper cover, let the top cover hang on the pothook, and the upper cover landed on the laminating board.

7.2.4 Unload the teflon fabric which hang up with the upper chamber, at the same time, unload the four pedestal of teflon bracket (both sides has two) and each pedestal has two bolts. And then lift down to prevent the replacement of silicone rubber sheet inconvenient.





博碩®

Boostsolar Photovoltaic Equipment Co., Ltd

7.2.5. Screw off all the M10 screws around the upper chamber which are used to fixed the silicone rubber sheet, open the upper cover. Left the worn silicone rubber sheet and the sealing strip on the laminating board, remove the worn silicone rubber sheet away, but do not change the position of sealing strip. If moved away, please land the upper cover in appropriate location, keep the hole of upper cover and the hole of sealing strip in a line. If □6 sealing strip damaged, then replace it. For details see the 7.7 Replacement of□6 sealing strip. Open the upper cover and roll out new silicone rubber sheet (Note: Do not move the sealing strip). Four sides evenly placed, dropped upper cover, paint a line along the four sides of upper cover, and make a mark in order to check swell increment after heating.

7.2.6. Heating the laminating board temperature 5° higher than the working temperature, baking for 1 hour to make the silicone rubber sheet expand naturally. In the baking time to open the upper cover 5mm gap so that the silicone rubber sheet can expand naturally.

7.2.7 One hour later, ask four persons to pull the silicone rubber sheet in four corners slightly, and then close the cover, drill on the holes of upper cover, fit M10 bolts tightly.

7.2.8. After locking, open the vacuum pump to carry out upper chamber vacuumize, then close it to carry out lower chamber vacuumize, two minutes later locking the bolts again.

7.2.9. Air charge into the lower chamber and open the upper cover, raising the upper cover to the highest position manually, push back the four rods, let the top cover and the upper cover landed together.

7.3 Replacement of Teflon Fabric

7.3.1 On starting up interface, press equipment debug button, enter the password 51072100, enter into debugging interface. Press <Open Hook> button to open the security lock, then press <Open Cover> lift the upper cover to the highest position which should be 300mm distance to working board.

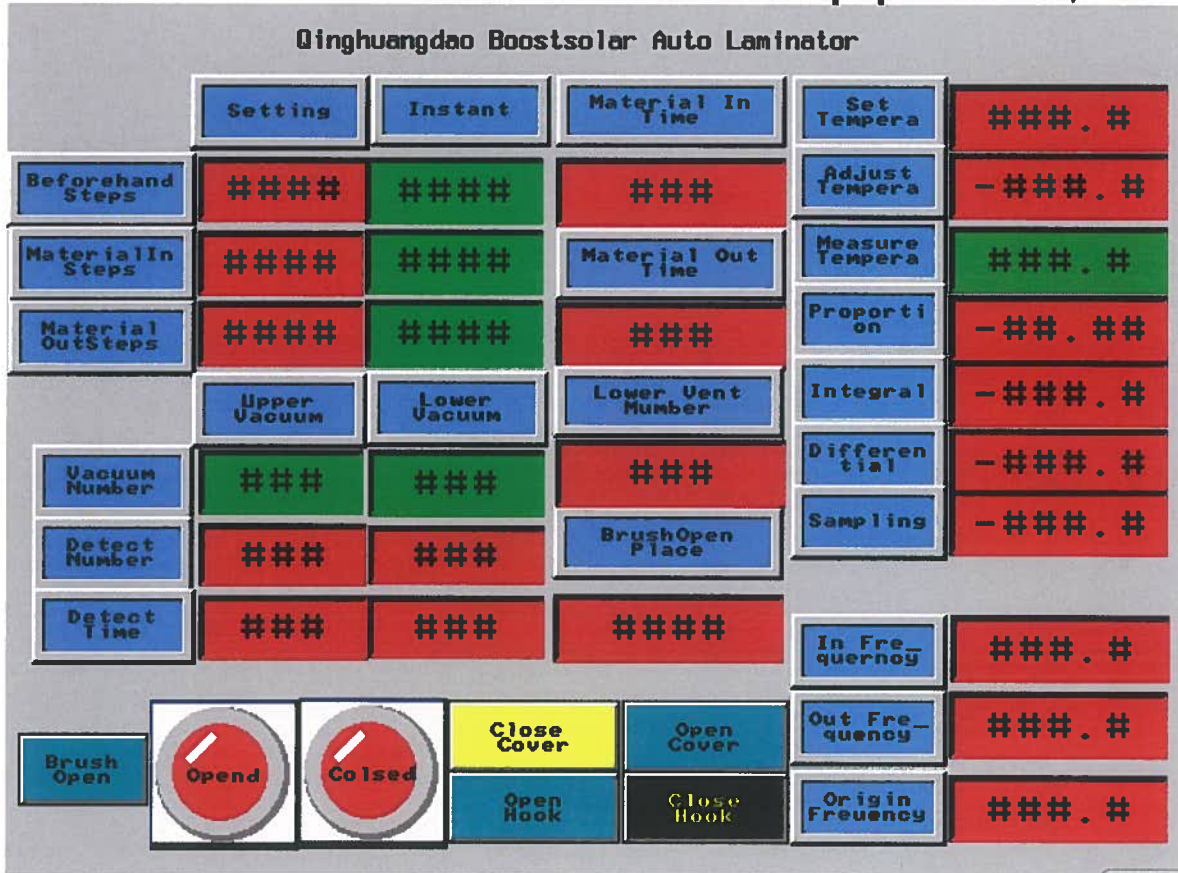

7.3.2 Beside the protection frame of the four open cover cylinders, each with a rod, pull out the rod about 100mm hang on the pothook near the cylinder protection frame is ok.

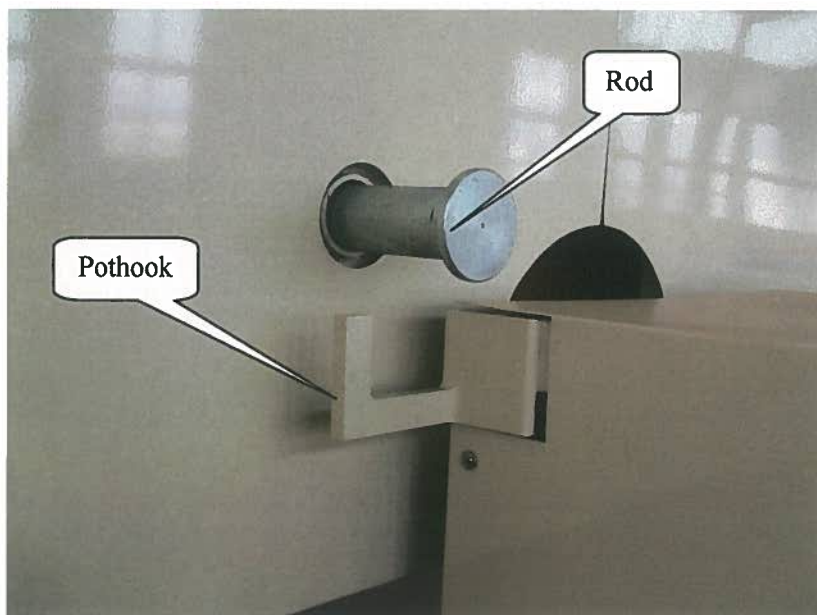

7.3.3 Press <Close Cover> on the touch-screen to close upper cover, let the top cover hang on the pothook, and the upper cover landed on the laminating board..

7.3.4 Screw off the two bolts of the two support saddles which on one side of Teflon, then take down the two support saddles, open the upper cover, take down the other side bracket from the support saddle and remove the worn Teflon fabric away.



7.3.4 Remove the worn Teflon fabric from the bracket, put on same specification Teflon fabric and install it according to the contrary sequence of unload , then the new Teflon fabric can be fitted. The distance between the two brackets from 3910mm—3920mm. Fix the installed Teflon fabric on upper cover, keep sagging during height limit. The distance between Teflon fabric and laminating board is 50mm—100mm.

7.4 Replacement of Teflon conveyor

7.4.1 Lift the top cover to working height, and open the cover till the light is lit, press “Go Ahead” button in the manual interface, stopped the pull rod at the roller of unloading bay of mainframe which could made the use of tools easily..

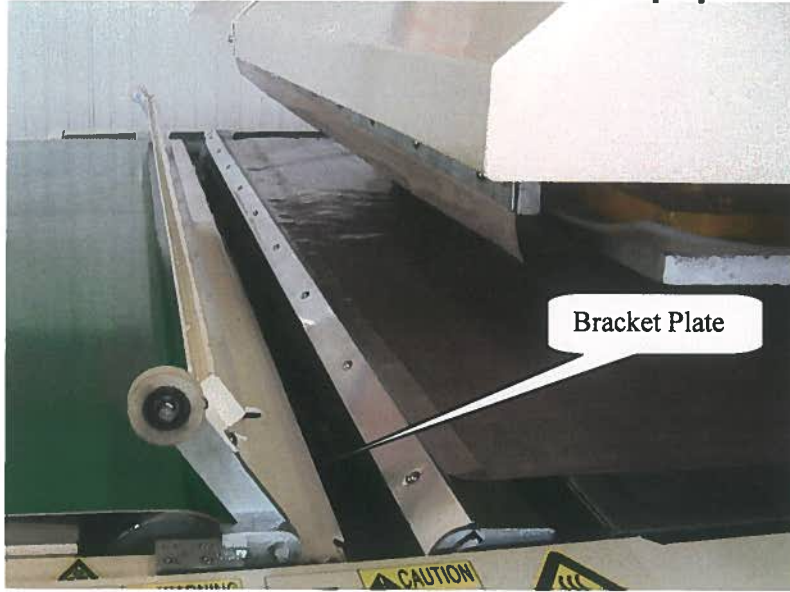

7.4.2 Remove the waste Teflon fabric of this side from the rod (screw off the bolts, then take away the plate from the bracket, at last remove the Teflon fabric), replace new Teflon fabric to the original position, buckle up the plate and then screw up the bolts.

7.4.3 Press “Go Ahead” button to stop the back-end pull rod at the roller which in the direction of loading material, then remove the waste Teflon fabric in the same way, install the new one. (Note: when install the back Teflon fabric rod, please set some space which probably is the radius of the drove roller)

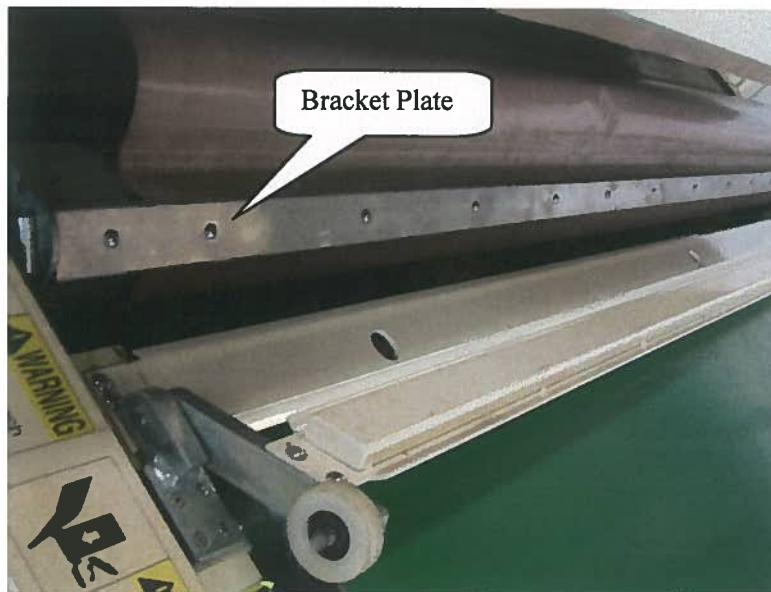



博碩®

Boostsolar Photovoltaic Equipment Co., Ltd

7.5 Replacement of Vacuum Valve Sealing Ring

7.5.1 The vacuum valve was developed by our company, for the high demanding of sealing precision, thus has a high requirement to the sealing ring. The main replacement include: sealing ring of the valve cover $\phi 53*5.3$, sealing ring of the cylinder piston rod $\phi 20*3.55$.



7.5.2 To check the sealing ring of valve cover and cylinder piston rod once a month, replace them every three months.

7.5.3 The vacuum valve body is under the laminating board. In front of the mainframe, open the middle side plate in front of the mainframe, repair worker enter into the laminating board will see the vacuum valve connected with the vacuum tube, the thick black tube corresponding to the lower chamber vacuum valve, and the thin curve tube corresponding to the upper chamber vacuum valve.

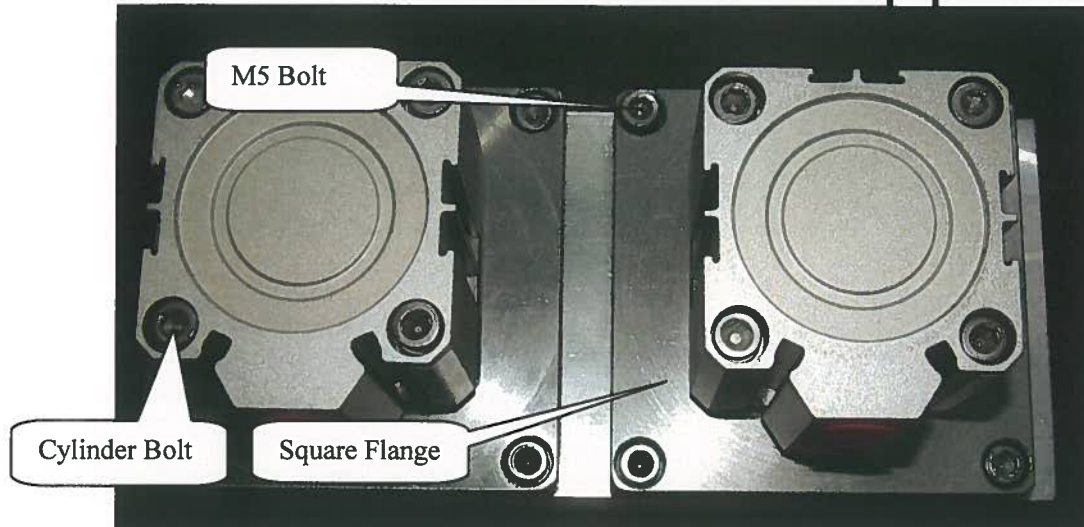

7.5.4 When replacing of sealing ring, repair worker enter into the laminating board, screw off the two square connecting flange which under the valve, each flange has four M5 inside hexagon bolts. Screw off the bolts can remove the small cylinder together, then can replace the sealing ring of the valve cover (Note: When replace the sealing ring, painting a layer of vacuum silicone grease, available in the toolbox).

7.5.5 On the basis of the above steps, we can replace the sealing ring of the cylinder piston rod.

(1) Screws off the floating connected valve cover from cylinder piston rod.

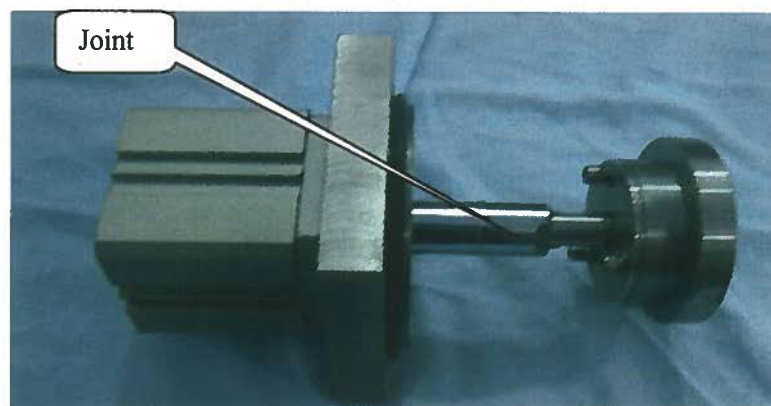

- (2) Screw off the four M5 bolts which behind the cylinder,
- (3) Remove the square flange of the valve body connection.
- (4) Remove the sealing ring of the connecting flange and the cylinder rod.



(5) Replace the new sealing ring.

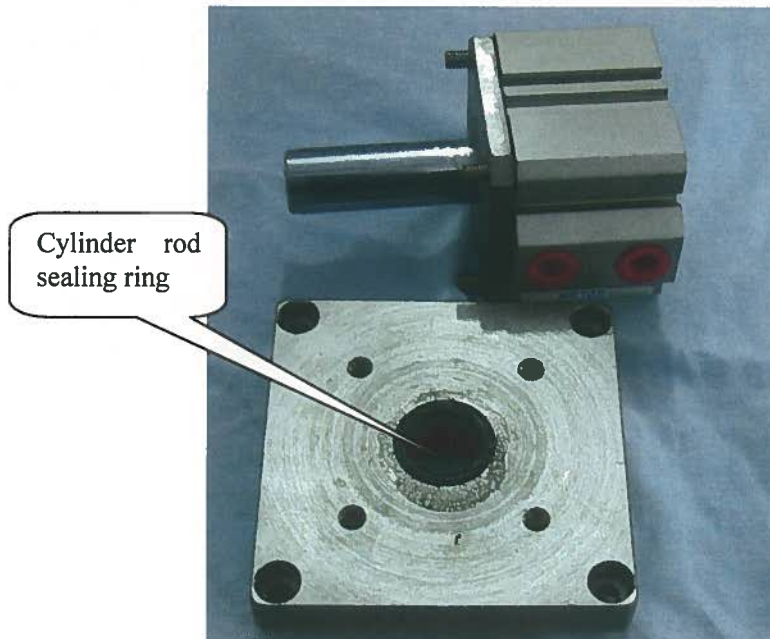

(6) Paint some vacuum silicone grease on the new sealing ring which has the effect of sealing and lubrication.

(7) Assembly the removed parts together, all installed on the vacuum tube.

7.6 Replacement of $\phi 14$ Sealing Strip

Open the upper cover, remove the old sealing strip, take a new $\phi 14$ sealing strip which length is 1220mm, press the new one into the groove, cut off both ends at 45° angle, painted with glue. Joint tightly and press it into the groove. (Method of operation is the same as the replacement of $\phi 14$ sealing strip).

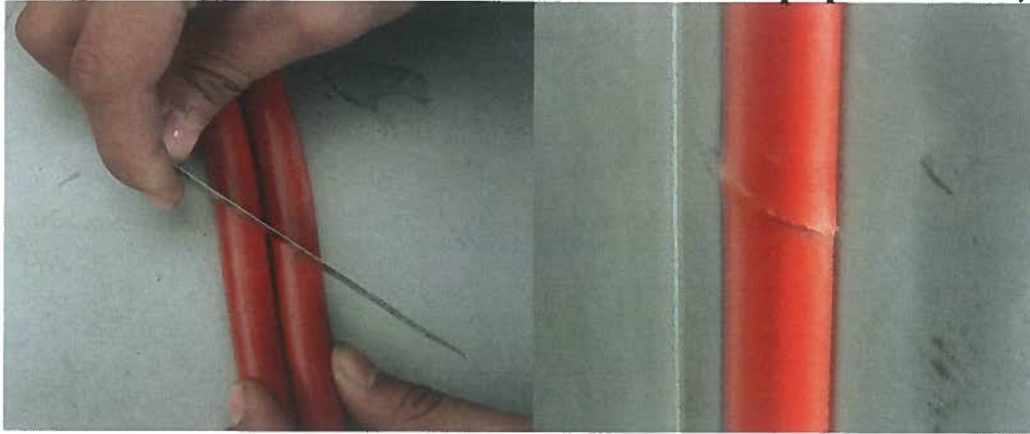

7.7 Replacement of □6 Sealing Strip

Remove the silicone rubber sheet before replacing □6 sealing strip, details please refer to 7.2 Replacement of Silicone Rubber Sheet. Take a new □6 sealing strip which length is 1220mm, press the new one into the groove, cut off both ends at 45° angle, and painted with glue. Joint tightly and press it into the groove, close the cover thus to compact the sealing strip.

7.8 Adjustment of the Loading Board & Unloading Board

Screw off the bolts from both ends cover of loading board and unloading board, and then remove the cover, loosen the fastening screws of both sides, adjust the adjustable bolt, observe the conveyor , till adjust normally, then screw up the fastening screws tightly.

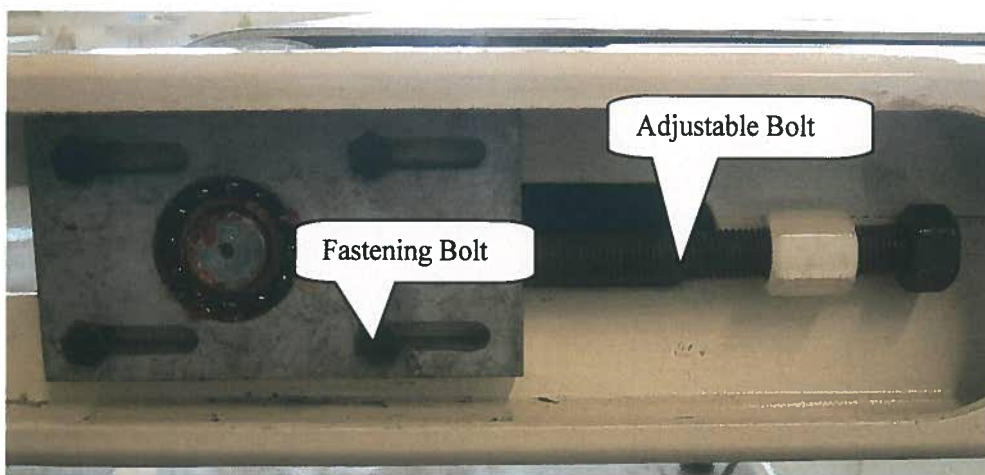

7.9 Open the Safety Hook

On the interface of touch-screen, enter into adjustment interface;



博碩®

Boostsolar Photovoltaic Equipment Co., Ltd

press the button of <Open Hook>to open the safety hook; press the button of <Close Hook> to close the safety hook, or open the manual switch of the safety hook electromagnetic valve in the pneumatic box by hand.

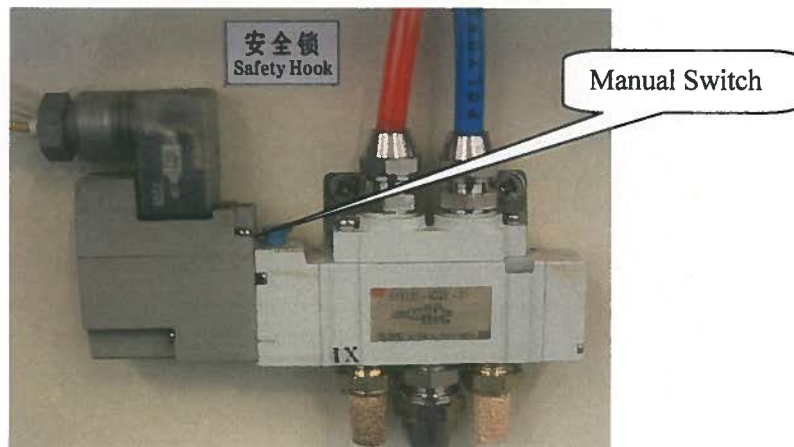

7.10 Replacement of O Shape Sealing Ring of Lower Vent Valve

1. Drive the Teflon conveyor on the top of the laminating board. Cut off air supply and power.
2. Screw off 4 pieces M5×40 bolts of lower vent valve near the cylinder with M5 inside hexagonal spanner, and remove the cylinder.
3. Remove the 20×3.550 sealing ring from the top thread.
4. Use cotton to dip rubbing alcohol to wipe the sealing ring groove clean.
5. Put the new 20×3.550 sealing ring into the groove, compact it.
6. Paint some vacuum silicone grease on the top of the O shape sealing ring.
7. Justify the position of cylinder and housing and then screw down the M5×40 bolts.



Lower Air Charge Valve

7.11 Replacement of Heater

1. Cut off the laminator power supply; make the laminator in the initial work state.
2. Remove the shield which around the heating station.
3. Open the oil valve which at the bottom of the heating station to release oil, when the oil level dropped to the height around half of the heating oil tank stop oil outlet.
4. Remove the protection cover on the top of heater.
5. Remove the six M8×25 bolts which used to fixed the heater.
6. Insert the new heater (9KW) and correct its position, screw up M8 × 25 bolts.
7. To connect high-temperature lines according to the original location and order.
8. Install protection cover.
9. Install the shield around the heating station.



博碩®

Bootsolar Photovoltaic Equipment Co., Ltd

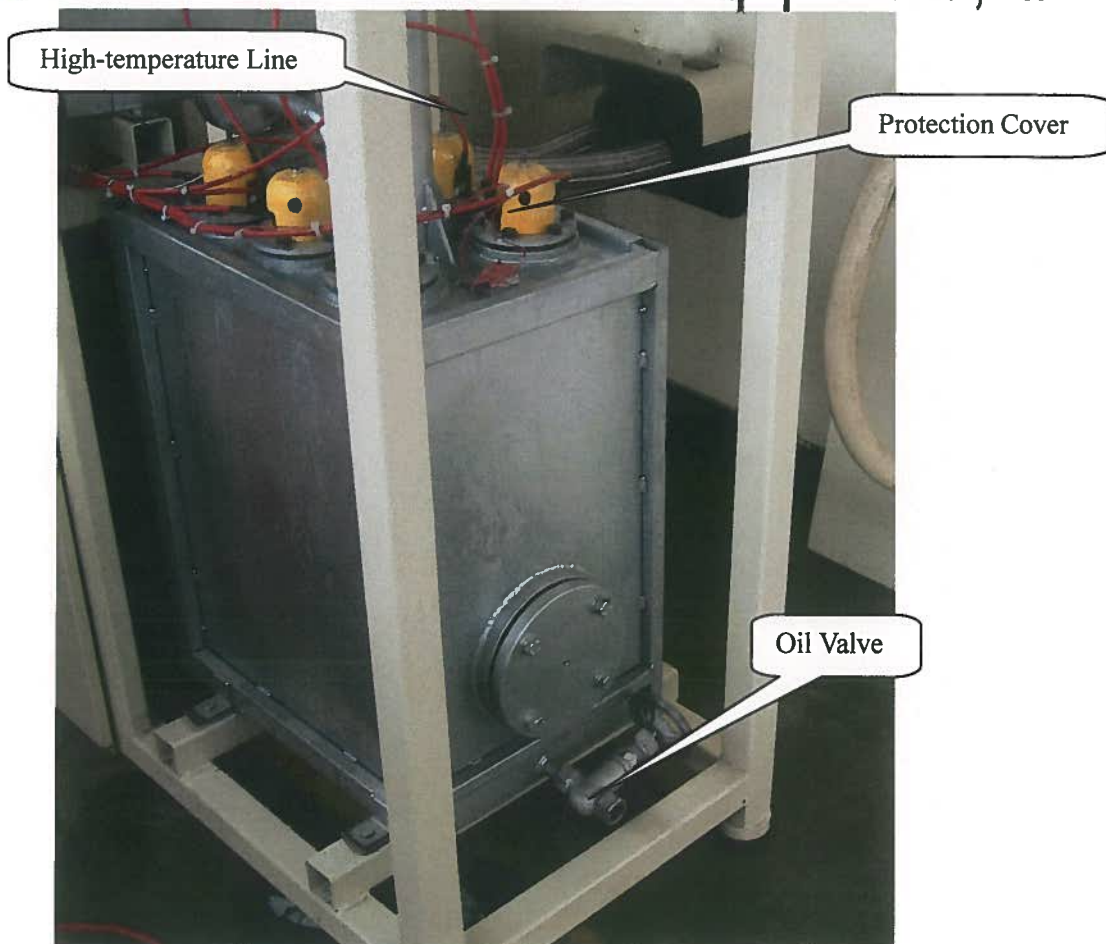

Component model of oil line's sealing:

Asbestos pad or PTFE pad for heater : 69×86×2.5 ;

PTFE pad for oil pipeline joint: 65×120×3.5 ;

PTFE pad for oil pipeline flange joint: 37×65×2

Chapter 8 Oil Heater Instruction

8.1 Oil Heater Brief

8.1.1 The total heating power of the heating station which go with Bootsolar automatic solar module laminator is 62KW (pump motor 7.5 KW, heating pipe 54 KW).

8.1.2 Heating temperature: $\leq 200^{\circ}\text{C}$

8.1.3 Power and the proposed power line: 380V 3 – phase 5 line 25 mm²,



博碩®

Boostsolar Photovoltaic Equipment Co., Ltd

copper cable.

8.1.4 Conducting oil model: SD340 conducting oil.

8.1.5 The heating pipe divided into two groups, when heating startup, the two groups of heating pipe working at the same time, greatly shortened the equipment heating time. When the temperature of equipment reached the using temperature, one group of heating piles will close automatically, only one group heating pipe working to maintain the equipment temperature and save the electrical energy for users.

8.1.6 The temperature control method adopts PID self-tuning technology.

8.1.7 Users can set different heating temperature according to different requirements.

8.1.8 Boostsolar has set up a security warning system, when the heating station temperature exceeds the set temperature, it will alarm automatically, meanwhile shut off the power automatically.

8.1.9 Heating station installed oil low-down warning device.

8.2 Usage.

8.2.1 Before using, connect the equipment in and out oil hole with a metal pipe or high temperature resistant metal hose to ensure that close connection. Add a high- temperature gland bush to the joint, the middle of the pipelines may be required to install a valve, connection flange can be used 1.6 Mpa – flange welding.

8.2.2 After the heater placed, ensure that the expansion oil tank above the location of the equipment thermal heating plane.

8.2.3 Close the oil valve at the bottom of the main oil tank of the heating station.

8.2.4 Oiling! (Check carefully before oiling to ensure that valves between the heater and the heating equipment are closed entirely).

8.2.5 The position of oiling hole at the top of heater expansion oil tank.

8.2.6 The speed of oiling should not be too fast, otherwise go against to release the air in the equipment.

8.2.7 The oiling height will display through the liquid pipe on the expansion oil tank, generally the oiling height should not exceed the highest



博碩®

Boostsolar Photovoltaic Equipment Co., Ltd

standard line of the observation hope, and just beyond the minimum standard



line is better.

8.2.8 Filling oil to the standard line, open the cycle oil pump to run for dozens of seconds and then stop immediately to observe for a period of time, when the liquid level has no change, then could be end of the oiling.

8.2.9 Turn on the heating station.

8.2.9.1 The heating station temperature setting is on the touch – screen panel, the control button is in the touch – screen too (before open the total power supply of the equipment, to ensure the automatic air circuit breaker of the distribution box of the main laminator and the heating station for the‘ON’status).

8.2.9.2 Open the general power supply switch of the equipment, at this time the laminator and the heating station will heat at the same time. The power indicator of the heating station dashboard is lightened which means the heating station power has been connected.

8.2.9.3 First, set the temperature on the touch – screen according to the requirements, then following the operation sequence to carry out: Oil pump open--heating open. At this stage, the oil pump indicator and the heating indicator on the dashboard in front of the heating station followed by lighting, which means both the oil pump and heater are startup.

Note : The sequence of oil pump startup and heating startup can not be reversed, otherwise can not run the heating function.

8.3 Closedown heating station.

First closedown heating system, then closedown oil pump.

8.4 Caution

8.4.1 Hot oil pipeline and the heating oil tank installed insulating course



博碩®

Boostsolar Photovoltaic Equipment Co., Ltd

to reduce heat energy loss. But generally, the expansion oil pipe and expansion oil tank without insulation, not set up valves.

8.4.2 Remind: There has **strong current** and **high temperature** in the heating station, so the operators should pay attention to security carefully.

8.4.3 It is forbidden to run the oil pump before fill the conductive oil into the heating station, to avoid damage the equipment.

8.4.4 Any case of emergency, equipment can be stopped by the emergency button.

8.4.5 Man- made loose joints and flange of oil pipeline is strictly prohibited in the normal course of using equipment, to prevent high temperature hot oil spray and wounding mankind.

8.4.6 As the heat energy loss can not be avoid in the process of oil transport, when there has a large temperature difference between the thermal equipments temperature and the heater set temperature, the operator can adjust the value of setting temperature on the touch -screen to compensate the temperature difference.

8.4.7 The heating station oil tank filter is proposed cleaning annually. The filter was fixed on the exit which connects to the oil pump.

8.5 Malfunction Estimation and Maintenance

8.5.1 Malfunction phenomenon: Hot oil temperature instability.

Possible reasons: (1) PT 100 platinum resistance damaged ; (2) Heating pipe damaged.

Carefully check all lines, found the problems and solve them. Check the temperature or reset. If the problem still exist, consideration should be given to heating pipe failure or

PT 100 platinum resistance failure, maintain or replace it. PT100 position is on the top of the heating oil tank and is an internal component into the oil tank.

8.5.2 Malfunction is: The temperature rise beyond the security setting, over-temperature protection does not work.

Possible reasons: (1) Temperature setting problems (2) Over-temperature sensor damaged.



博碩®

Boostsolar Photovoltaic Equipment Co., Ltd

Check or reset temperature, if the problem still exist, consideration should be given to Over-temperature sensor which can be replaced. Over-temperature sensor is on the top of heating oil tank, button shaped component.

When replace heating pipe or PT100 platinum resistance, the equipment must stop heating and wait the oil temperature down to the room temperature and release the internal conduction oil of the expansion oil tank.

Release oil valve set at the bottom, side of the oil tank.

8.5.3 Malfunction is: Heating station cannot startup.

Possible reasons: (1) Power lines problems or did not open the automatic air breaker in the distribution box of heating station; (2) Oil level on low side.

To resolve: Carefully to check the lines to see if there is a short circuit, open circuit or lack of power , check if the air circuit breaker of the distribution is opened. Check the oil level warning lamp lighten or not, if lighten means the oil level on the low side and need to add conducting oil.

8.6 Replacement Method of Oil Heating Pipe.

8.6.1 According to the method introduced by the previous to close the heater and turn off the power.

8.6.2 Waiting till the oil temperature dropped to below 50 °C.

8.6.3 Open the oil vent valve at the bottom of the heating oil tank, release the conducting oil of the expansion oil tank and expansion oil pipe, then shut down the oil vent valve. (No need to release all conducting oil of the entire circuit.).

8.6.4 Dismantle the plastic protection cover of the heating pipe; open the power fixed-line screw of heating pipe.

8.6.5 Screw off the six screws which are fixed on the heating pipe flange, remove the heating pipe.

8.6.6 Clean the remnants of the gland bush which on the connecting flange used to fix the heating pipe.

8.6.7 To smear heat resistance fluid sealant on the new asbestos, put on the connecting flange.

8.6.8 Add a new heating pipe, adjust well the position of heating pipe



博碩®

Boostsolar Photovoltaic Equipment Co., Ltd

flange and connecting flange to ensure the alignment screw eyes and compressed the gland bush.

8.6.9 Fix the heating pipe flange well with six screws.

8.6.10 Connect the power cord of the heating pipes, install the plastic protection cover.

8.6.11 Replacement of heating pipe completed.

8.6.12 Note: It is strictly prohibited to carry our oil discharge operation when the oil temperature did not fall down so as to prevent burns.

Form of heating pipe.

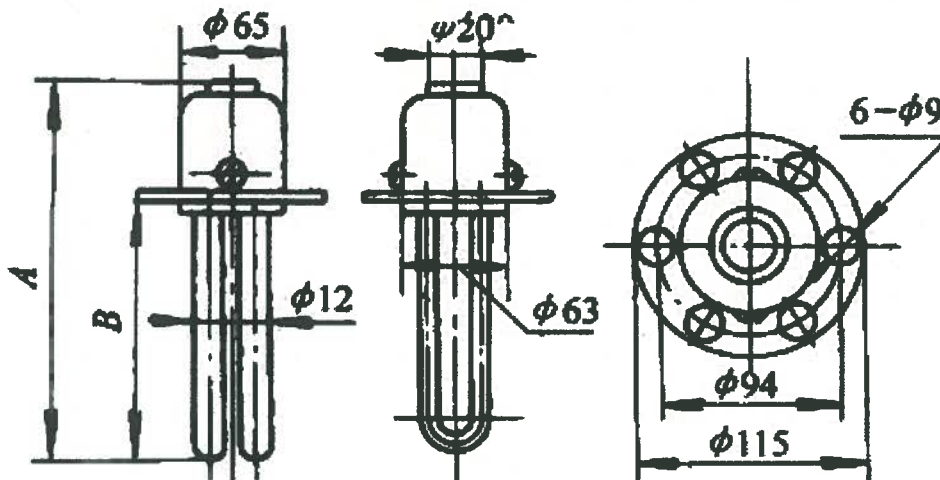

Chapter 9 Emergency Measures For Equipment Power Failure

9.1 Summary

In use process, equipment will inevitably come with the problem as power failure or other emergency situation, in this case, should take some measures to avoid or to reduce production loss. In order to meet this need, Boostsolar solar module laminator has set the manual operation system when power failure.

9.2 The recommended measures when power failure or air stopped

9.2.1 If there has sudden power failure or air failure when the equipment is under the state of laminating, operator can continue to maintain the



博碩®

Boostsolar Photovoltaic Equipment Co., Ltd

equipment in the current state, and do not make any operation to the equipment., keep the laminating processing, finish laminating within the given time and then remove the modules manually. (Note: To ensure there has enough air pressure to open the upper cover)

9.2.2 If there has sudden power failure or air failure when the equipment is under the state of vacuumize, we suggest operator to remove the modules manually immediately.

9.2.3 If there has sudden power failure or air failure when the equipment finish vacuumize processing but on state of pressuring, operator could go on inflating and pressuring to upper chamber manually, after the process of pressuring, continues to laminate till the process is over.

9.3. Methods of manually remove modules

9.3.1 Before manually remove modules, must complete the lower chamber vent manually.

9.3.2 Manual air charge operation valve is fixed in the electrical valve box of the equipment. Press the elastic lock on the box by hand to open the box door easily. In the center of the box has set up two manual operation valves which model is 4HV230-08. They are manual air charge valve and manual open or close upper cover valve.

9.3.3 Before manually open upper cover, must complete manual air charge of lower chamber. When the air charge going on, watch the vacuum gauge of under chamber at the same time to ensure that action completely finished. When the air charge is completed, place the handle of air valve in the middle position, and then you can open upper cover by the open cover valve manually. When the cover reach the maximum height (BSLB□ automatic solar module laminator set the maximum height of open cover is 300mm), place the handle of manual open or close cover valve in the middle situation, then the open cover operation completed.

9.3.4 Following figures are the manual air charge valve and the manual open or close cover valve:

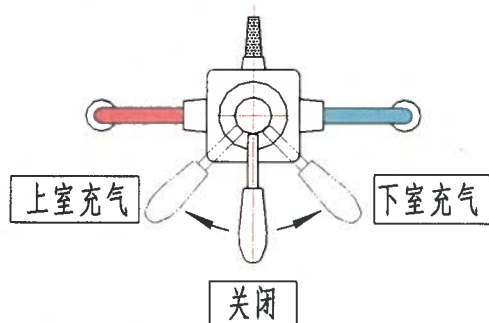
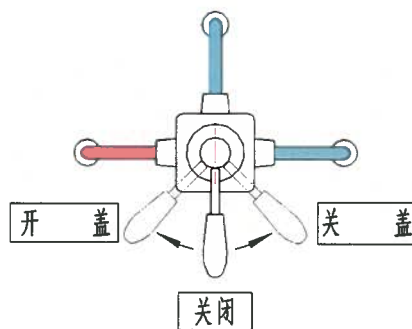
手动充气阀

手动开关盖

9.4 To Remind

9.4.1 The air source of manual open or close cover come from standby air of the air compressor package (user can also add air storage tank according to need).

9.4.2 The above facilities of manual air charge and manual open or close cover only used for emergency operation when equipment in sudden power failure or air failure situation. Please ensure the operation handle is in the middle position which means off state. And the operator is strictly prohibited to carry out any operation.

Chapter 10 Regular Maintenance of Equipment

10.1 In order to prolong equipments service life, ensure the user's interests, reduce or avoid losses, Bootsolar Company specially formulates this regular maintenance instruction.

10.1.1 The Equipments has equipped air filters to ensure the performance and the reliability of pneumatic components, thus require operators to check the quantity of impurity water in the filter's liquid cup and release the water timely. We suggest carrying out a regular inspection to the air filter once every four hours on the basis of 8 hours working time. Due to other reasons caused condensation water of the filter formed too quick, operator can shorten the



博碩®

Boostsolar Photovoltaic Equipment Co., Ltd

inspection cycle according to the actual situation.

Maintain Method: Standby equipment (The maintenance is strictly prohibited to carry out when equipment is running), shut off the air inlet of compressed air filter to make air inlet lose pressure, when pressure gauge indicators point to 0 Mpa, the water discharged automatically, and then to restore air supply.

Remark: As the seeper of air filter over filled lead to the water flowing into the pneumatic system of equipments, caused the equipments failure, such as solenoid burnt down, cylinder failure or other failures caused laminated modules scrap or other situation, Boostsolar will resume no responsibility for this.

10.1.2 The equipment open cover part is moving part, so it requires operators to check and maintain all connections and strengthen parts regularly, if find some parts of fastening screws loose, the equipment must be stop producing immediately and start to maintenance timely. Overhaul is proposed once a month.

This equipment open cover system is vertical lifting mode, as shown in figure.

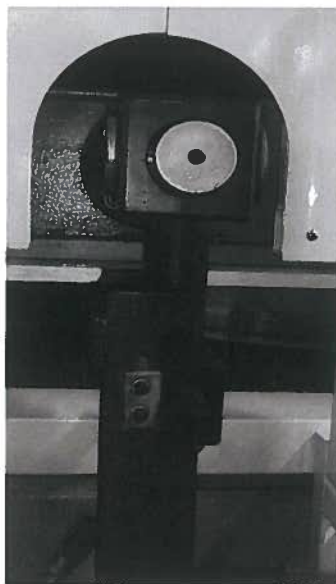

This picture only for reference, the actual pattern shall prevail.



博碩®

Boostsolar Photovoltaic Equipment Co., Ltd

10.1.3 The vacuum valve is the main components to ensure the equipment on a normal work situation. We suggest replacing the internal O ring once three months. At the same time, clean the piston of vacuum valve and the body of valve cavity. Each equipment attach O ring one set, model : $\phi 20*3.55$, users can purchase it from our company when use up.

The vacuum valve located at the connection of equipment lower part and lower chamber, as shown in the below picture:

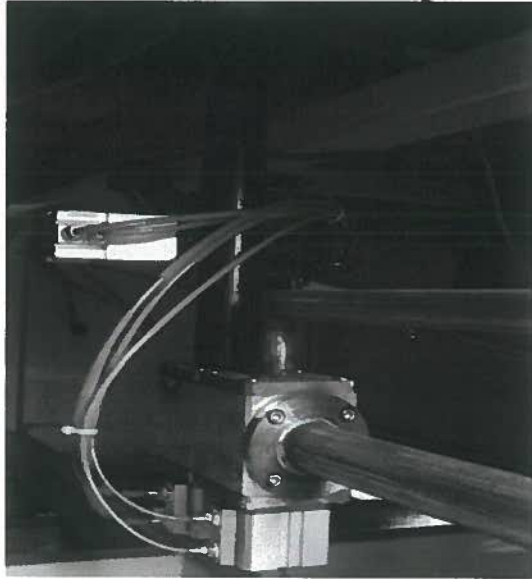

This picture for reference only, the actual pattern shall prevail.

Attach Figure

Equipment Diagram Form

