



Historic Severe Flooding on Staten Island





Hurricane Sandy Devastation, Staten Island





Severe Flooding, Hylan Blvd, following Sandy



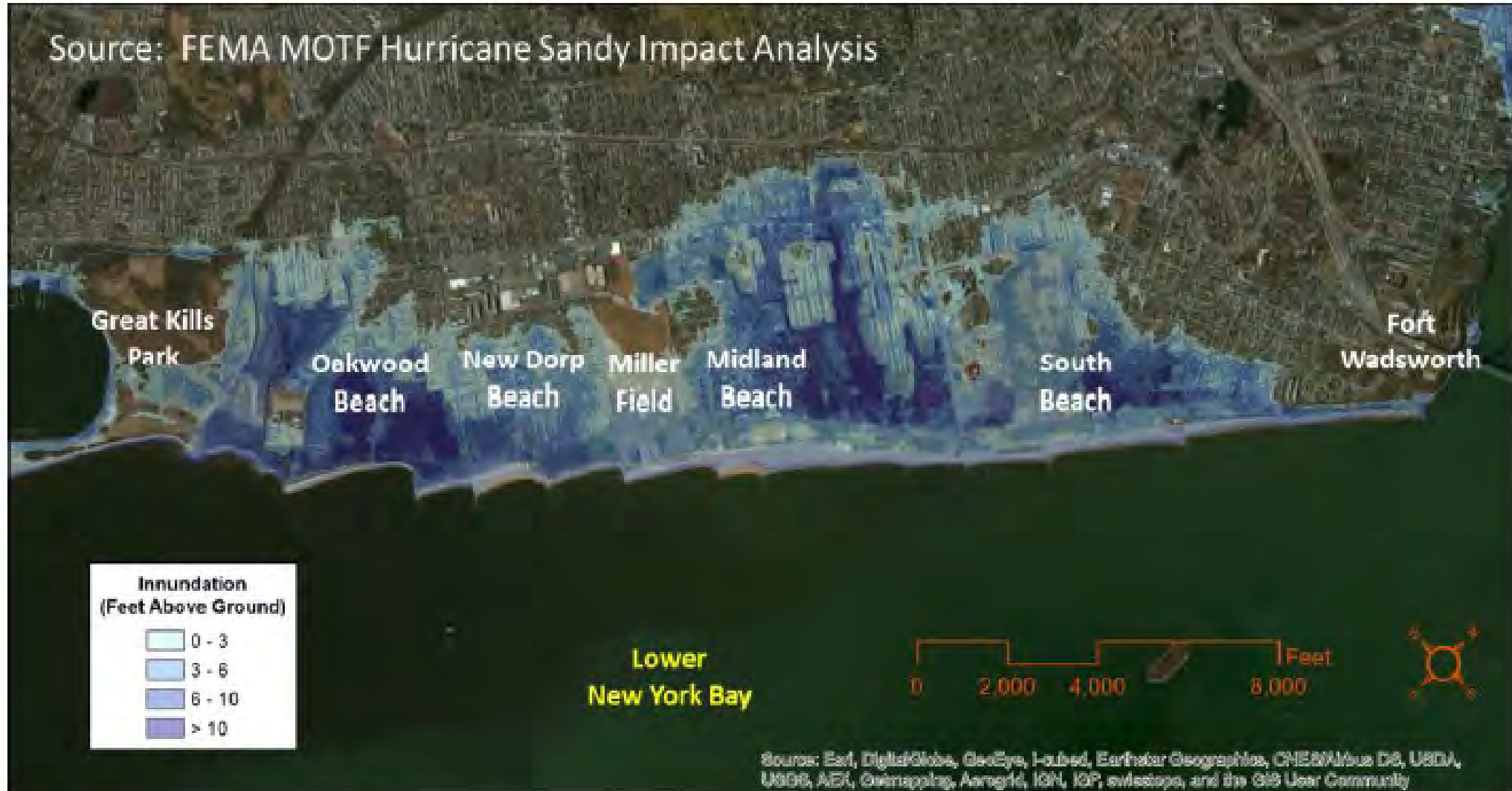

Figure 5-14: Hurricane Sandy Flood Inundation



- ✓ Final Feasibility Report approved by Assistant Secretary of the Army (Civil Works) December 2016
- ✓ Federal cost-share funded through Public Law 113-2
- ✓ Initial Construction cost-shared
65% Federal + 35% Non-Federal
- ✓ Operation & Maintenance
100% Sponsor responsibility & cost



<u>Estimated TOTAL Project Cost</u>	<u>\$615,000,000</u>
Estimated Federal cost-share (65%)	\$400,000,000
Estimated Non-Federal cost-share (35%)	\$215,000,000

Non-Federal cost-share includes estimated \$91 Million for required real estate acquisitions and relocations (utilities, boardwalk)



Design and preparation of plans & specifications initiated 2017

Project Partnership Agreement (PPA) executed February 2019

- US Army Corps of Engineers
- State of New York
- City of New York

Initial steps included significant data gathering for design:

- surveys & mapping
- utility investigations
- wetland delineation, biological monitoring, tree surveys
- geotechnical subsurface borings
- hazardous material assessment
- cultural resource investigations
- physical modeling
- interior drainage modeling

2D Tests in 3D Coastal Basin

Overtopping and structural performance



Geotechnical Borings



AUTHORIZED PLAN

- First line of defense against severe coastal storm surge flooding, wave forces
- Designed to function under a storm that produces water levels of 0.3% (300 year) flood event under historic sea level conditions

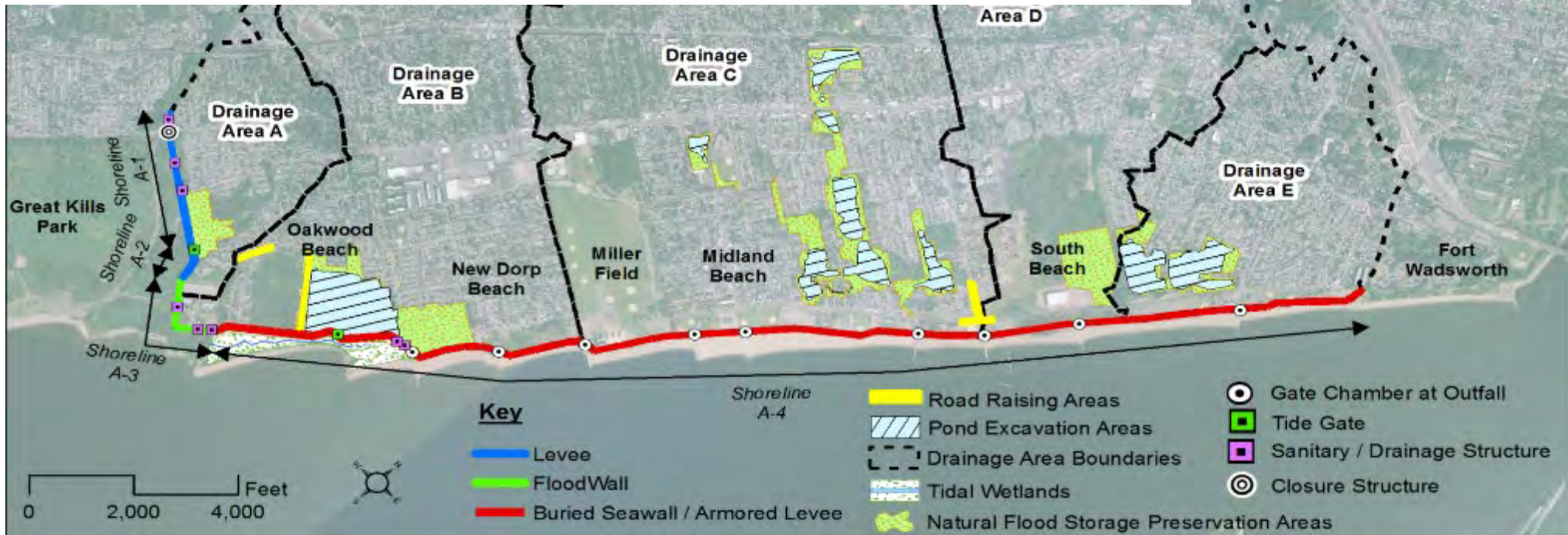

SITE PREPARATION – PHRAGMITES CONTROL

Site preparation – Phragmites Control Efforts
(multiple season – fall mow & summer spray) -
Interior Drainage Areas B, C, E



- South Beach (E)
- New Creek (C)
- Oakwood (B)

Mowing

- Starting shortly

Spraying

- Summer
- Multiple season effort to reduce growth in interior drainage areas

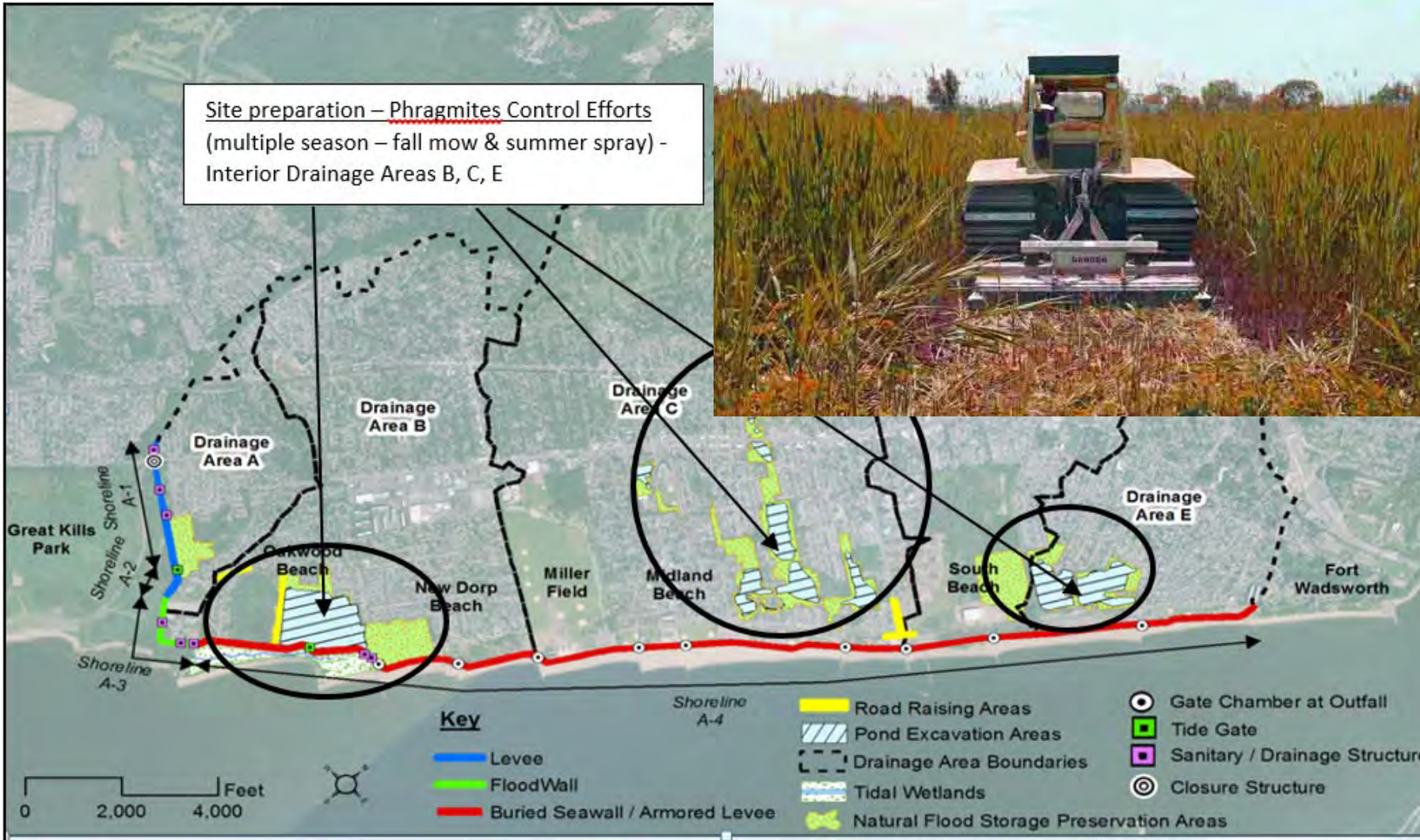



CONSTRUCTION CONTRACTS



CONTRACT #1 – INTERIOR DRAINAGE AREA E SOUTH BEACH AWARD LATE 2020

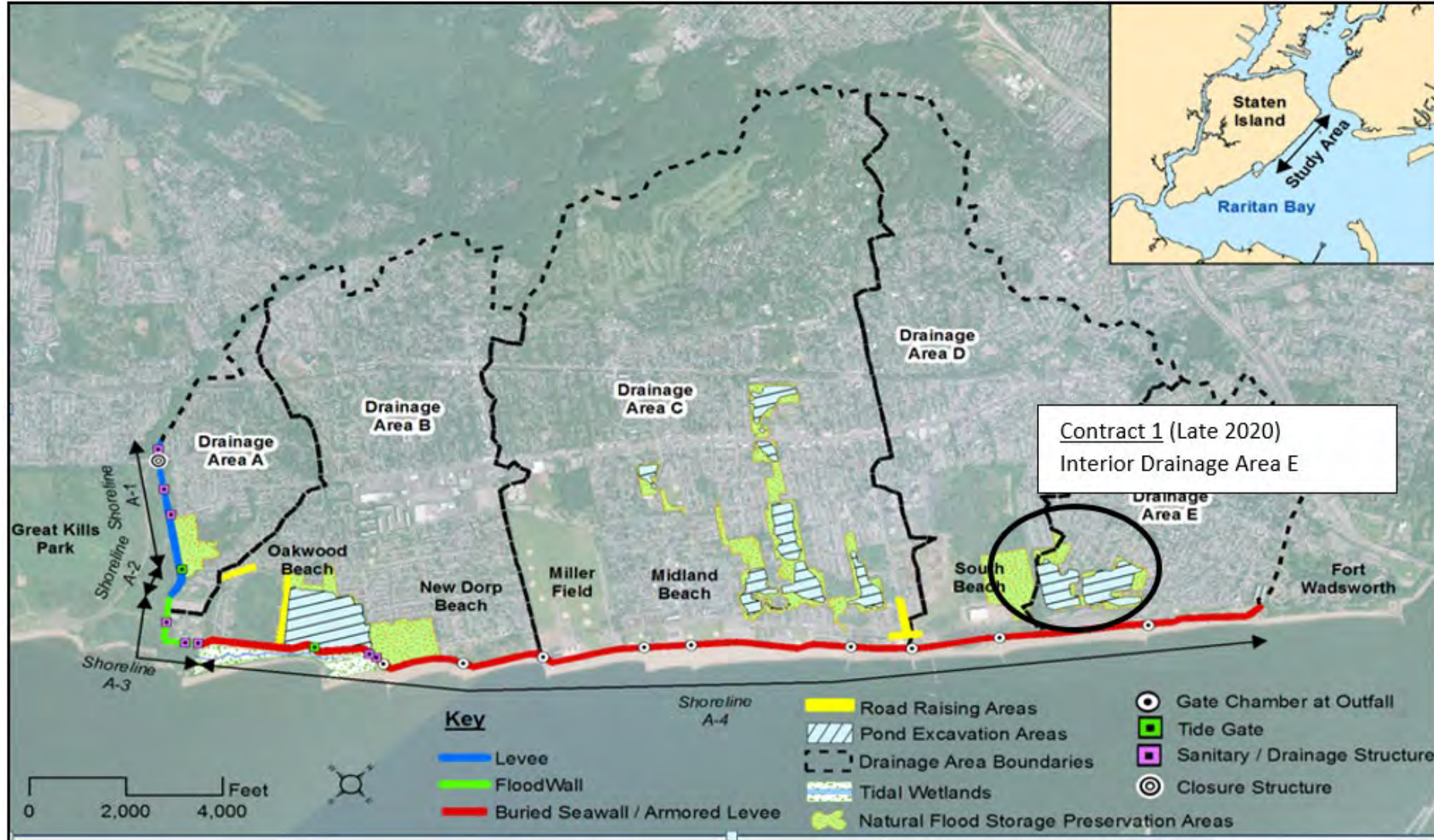

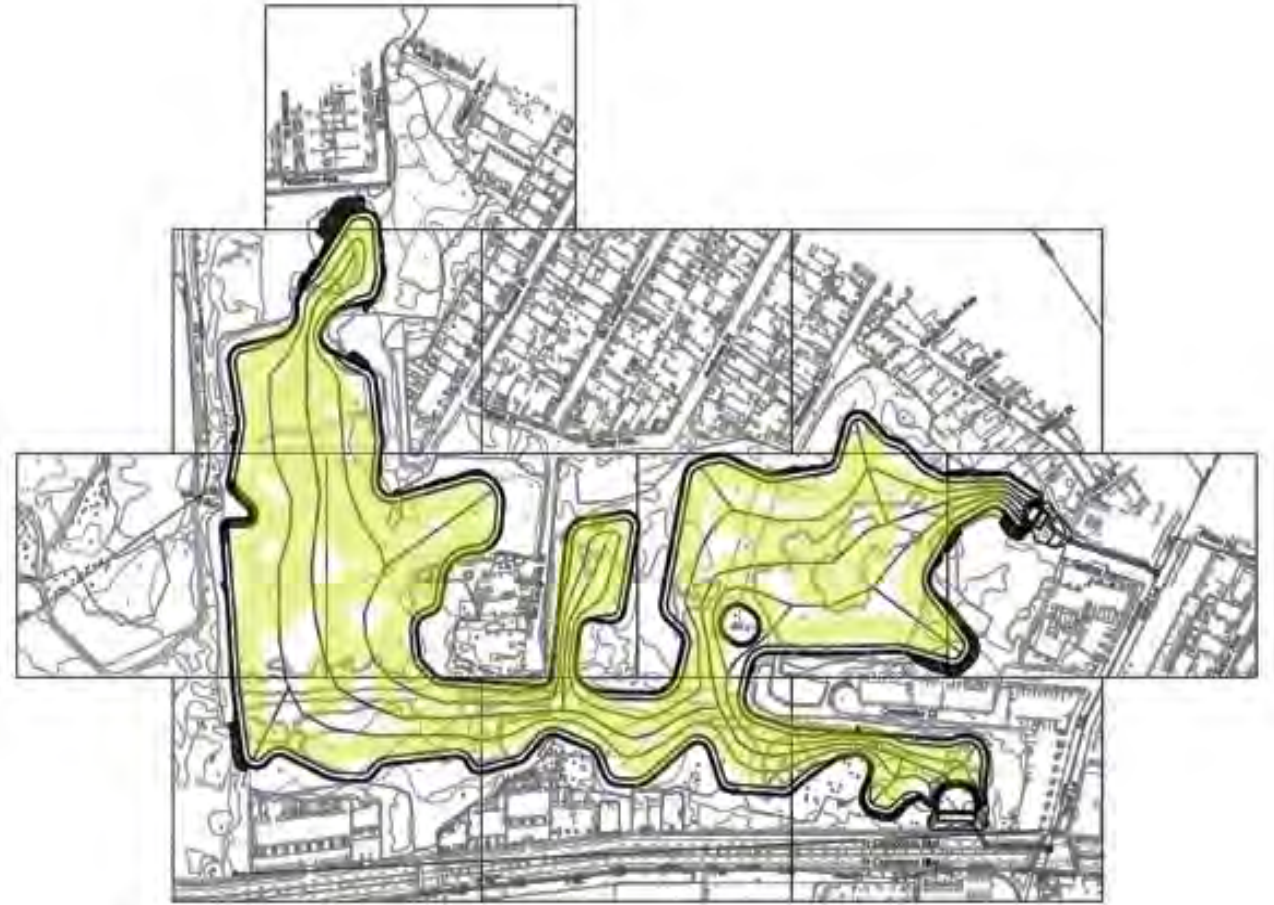

@ Father Capodanno & Sand Lane



Interior Drainage Area E

Excavated Pond

- 31 acres, excavate 100,000 cy
- Drainage Structures connect into Sand Lane outfall
 - Quincy Ave
 - Father Capodanno Blvd
- Connection into Quintard St
- Replant & seed pond with native wetland vegetation



Interior Drainage Area E

- Drainage Structure at Quincy Ave



- Drainage Structure at Father Capodanno Blvd



CONTRACT #2 – FLOODWALL OAKWOOD WASTE WATER TREATMENT PLANT AWARD 2021

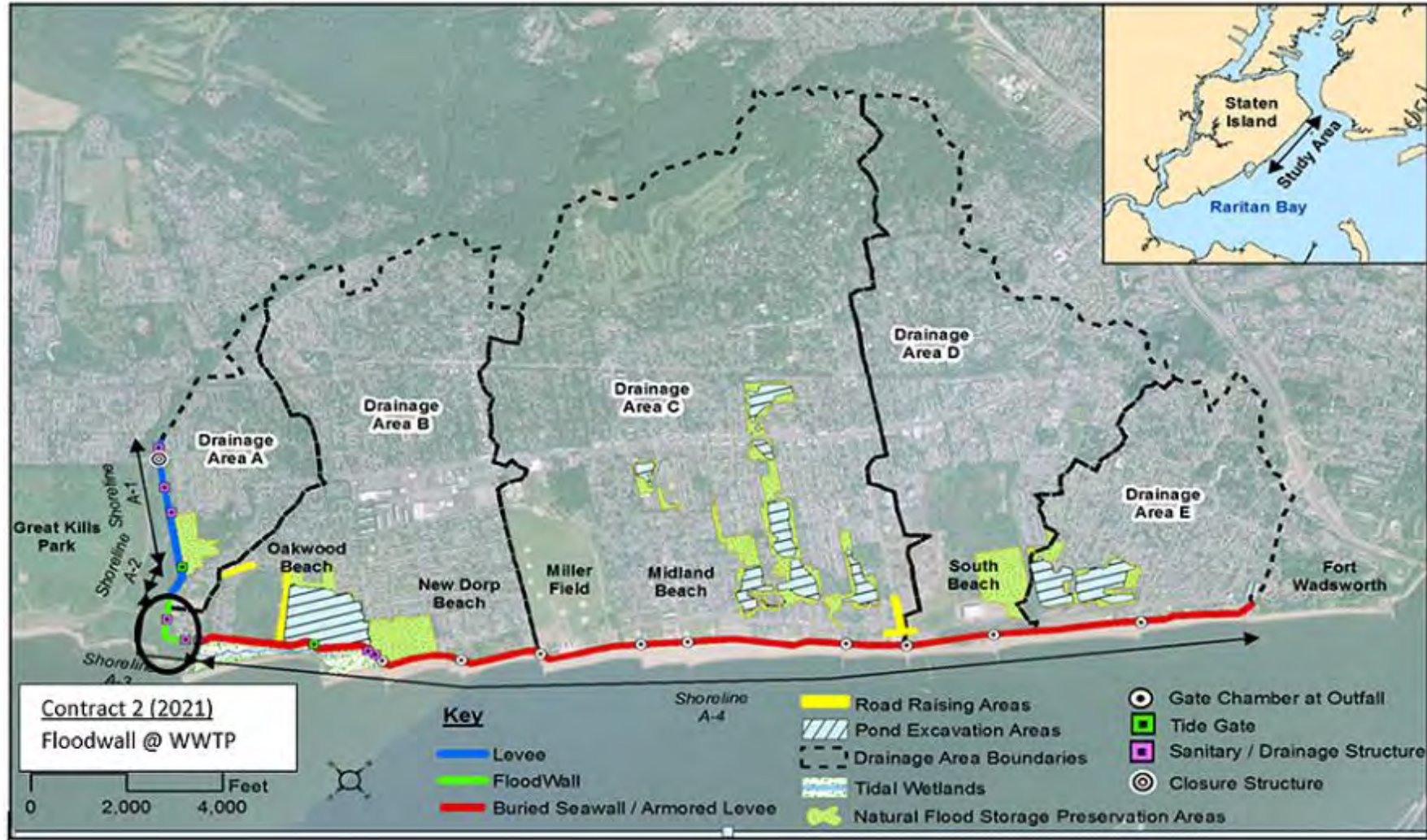



@ Oakwood Beach Waste Water Treatment Plant

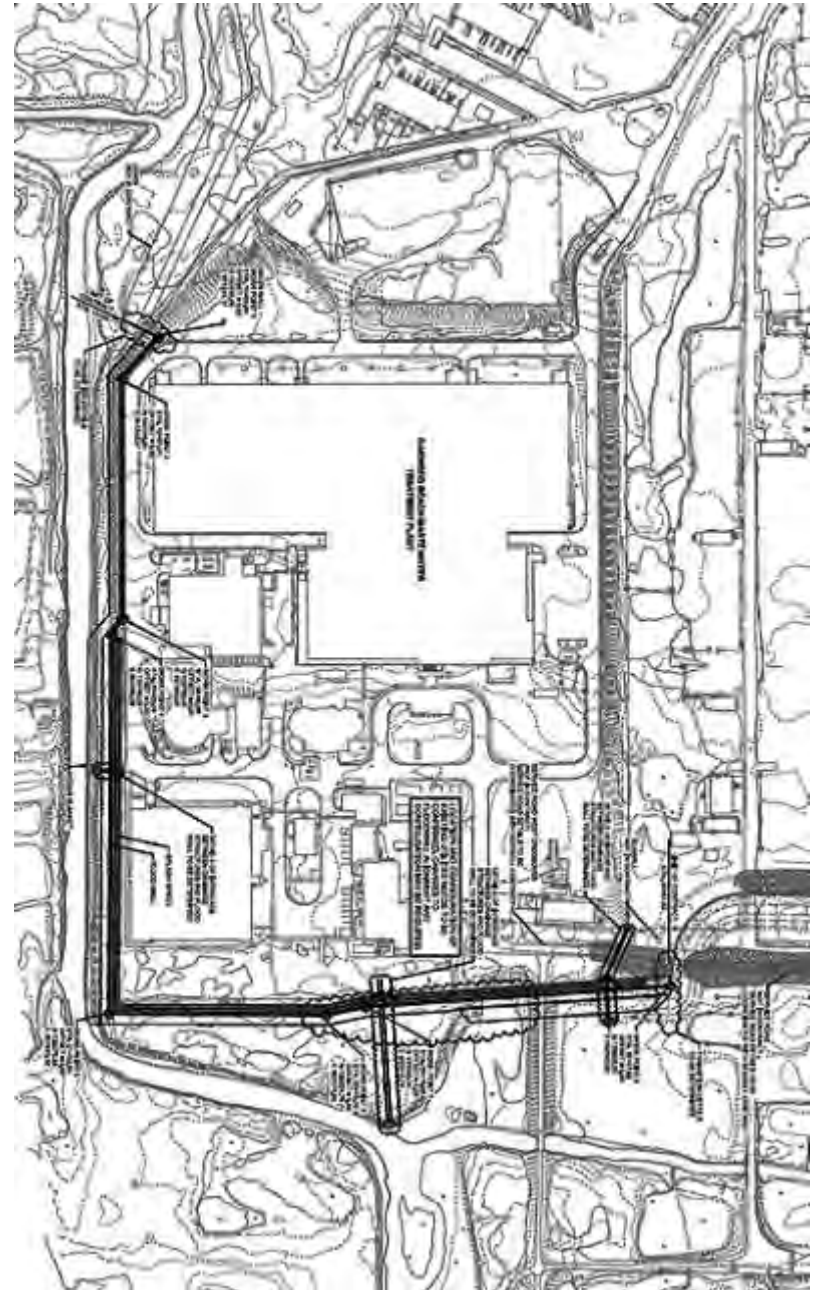

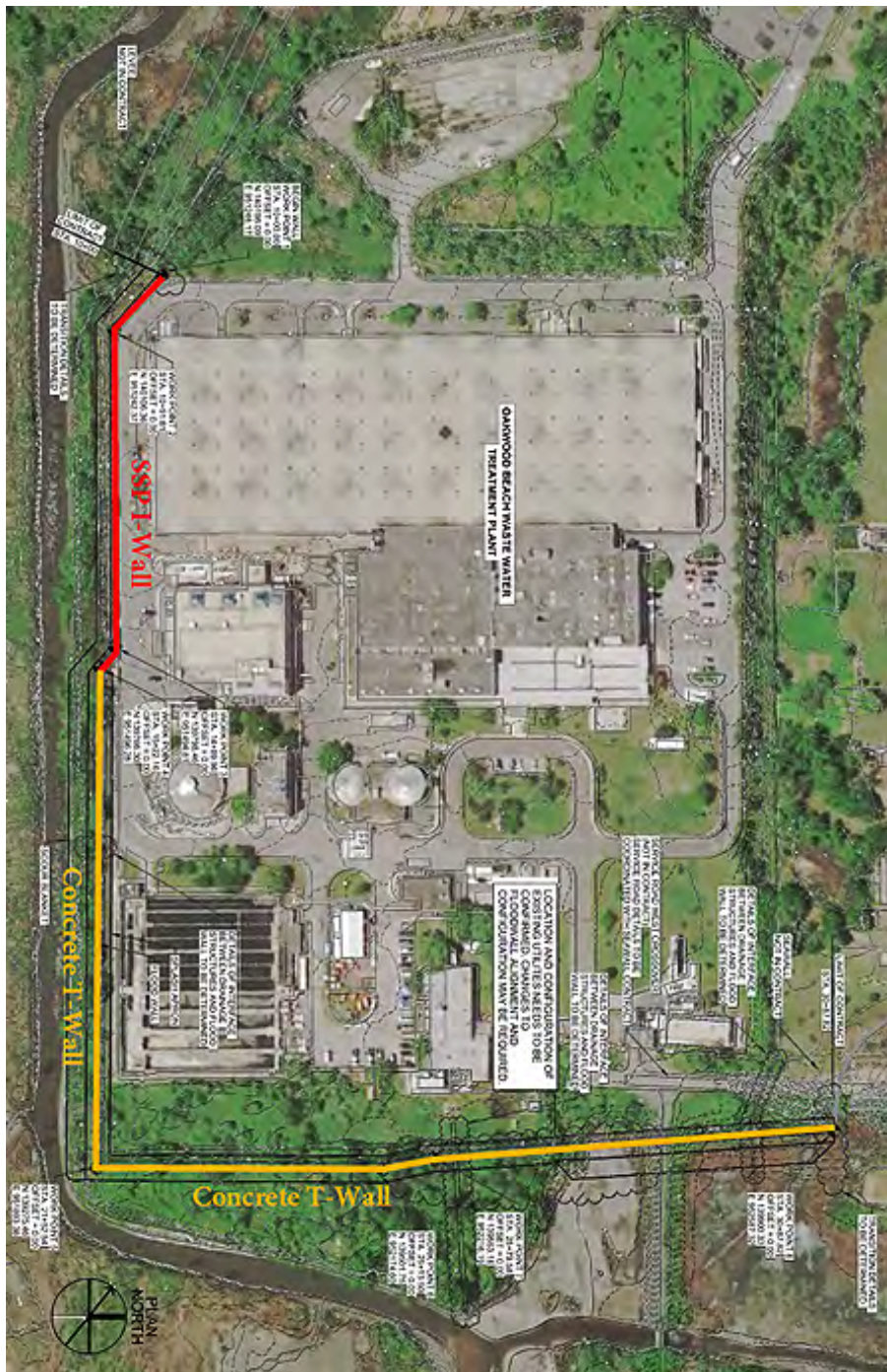

Floodwall @ Oakwood Treatment Plant 1,800 feet

- Sheet pile bulkhead with concrete cap (I-wall)
- Pile supported concrete floodwall (T-Wall)
- Significant utility & sanitary line modifications



Floodwall facing creek

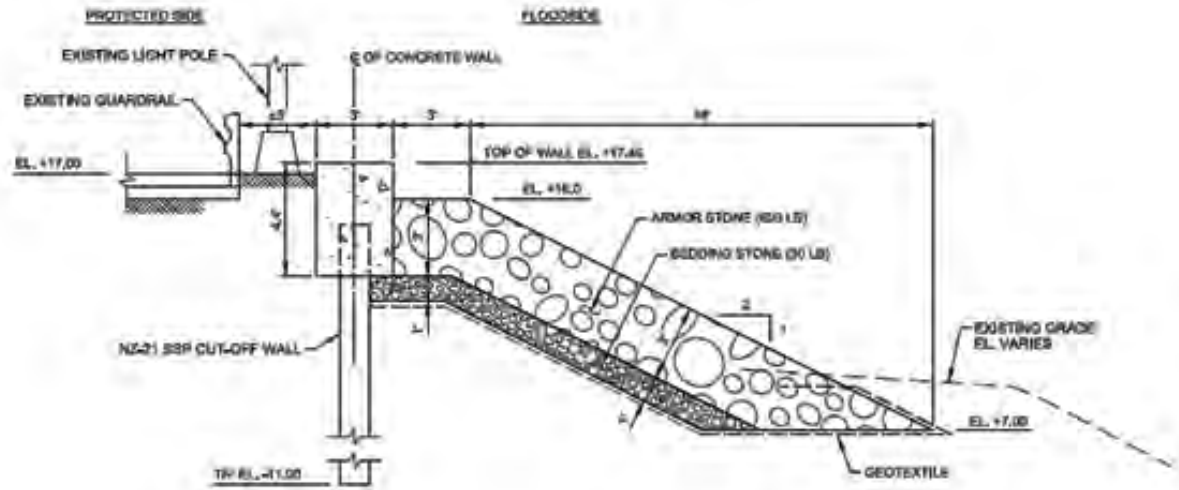

F6 TYPICAL I-WALL SECTION @ STA. 10+00 - 15+00
SCALE: 1/4" = 1'-0"

- Steel Sheet Pile
- I-WALL section
- Top of Wall
- +17.4 ft. NAVD88

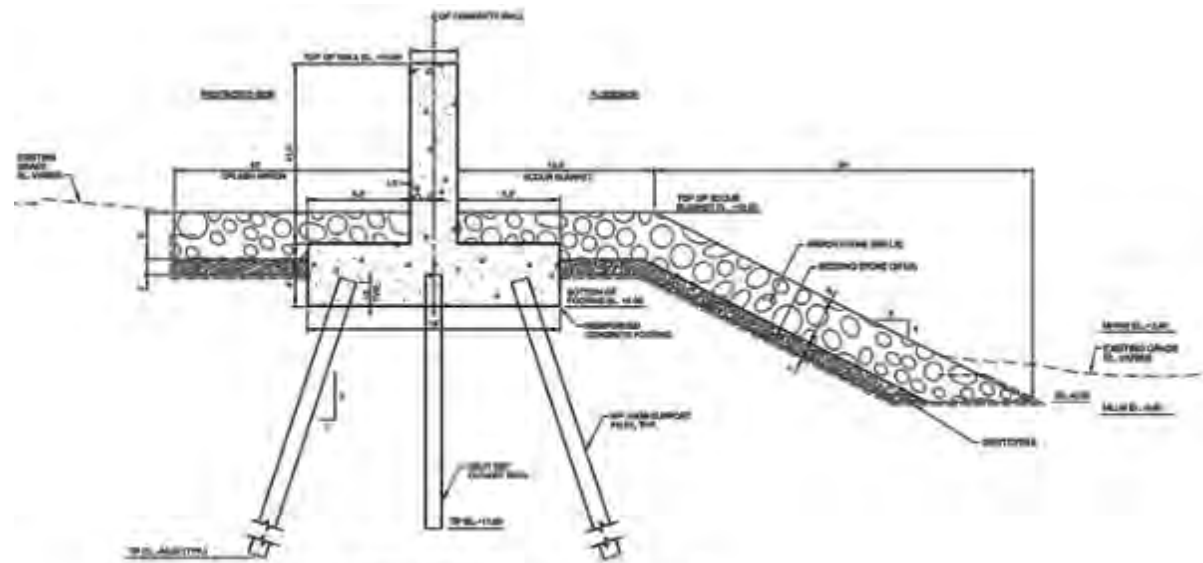

A1 TYPICAL SECTION @ STA. 15+50 - 21+50
SCALE: 1/4" = 1'-0"

- Pile supported concrete wall
- T-WALL section
- Top of Wall
- +19.4 ft NAVD88

Floodwall facing ocean

- Pile supported concrete wall

- T-WALL section

Top of Wall

- +19.4 ft NAVD88

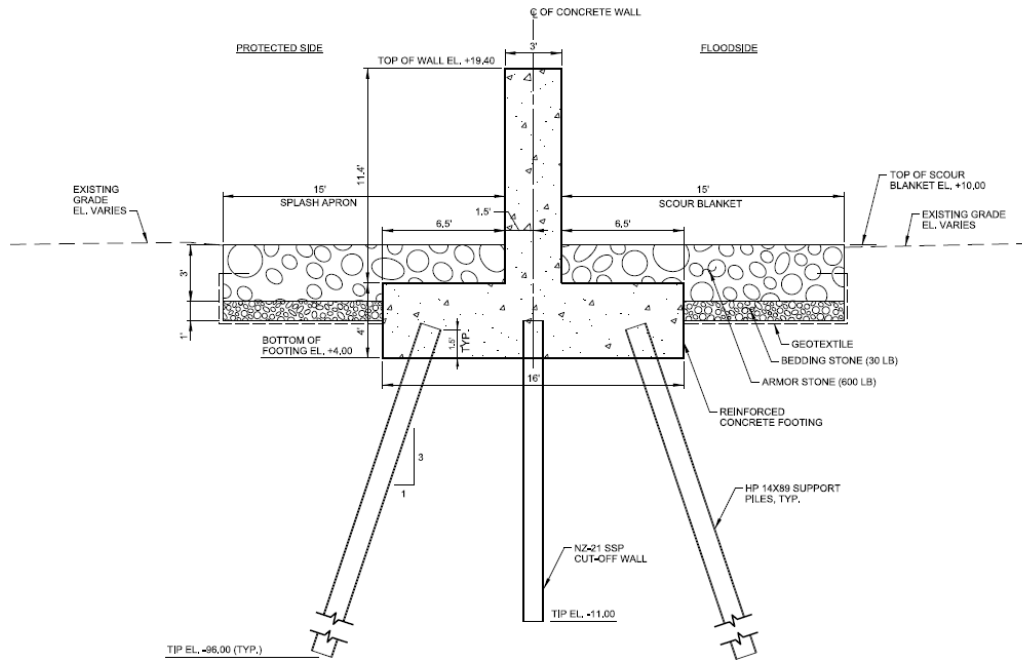

E1 TYPICAL SECTION @ STA. 22+00 - 27+22
SCALE: 1/4" = 1'-0"





CONTRACT #3 – INTERIOR DRAINAGE AREA C NEW CREEK AWARD 2021

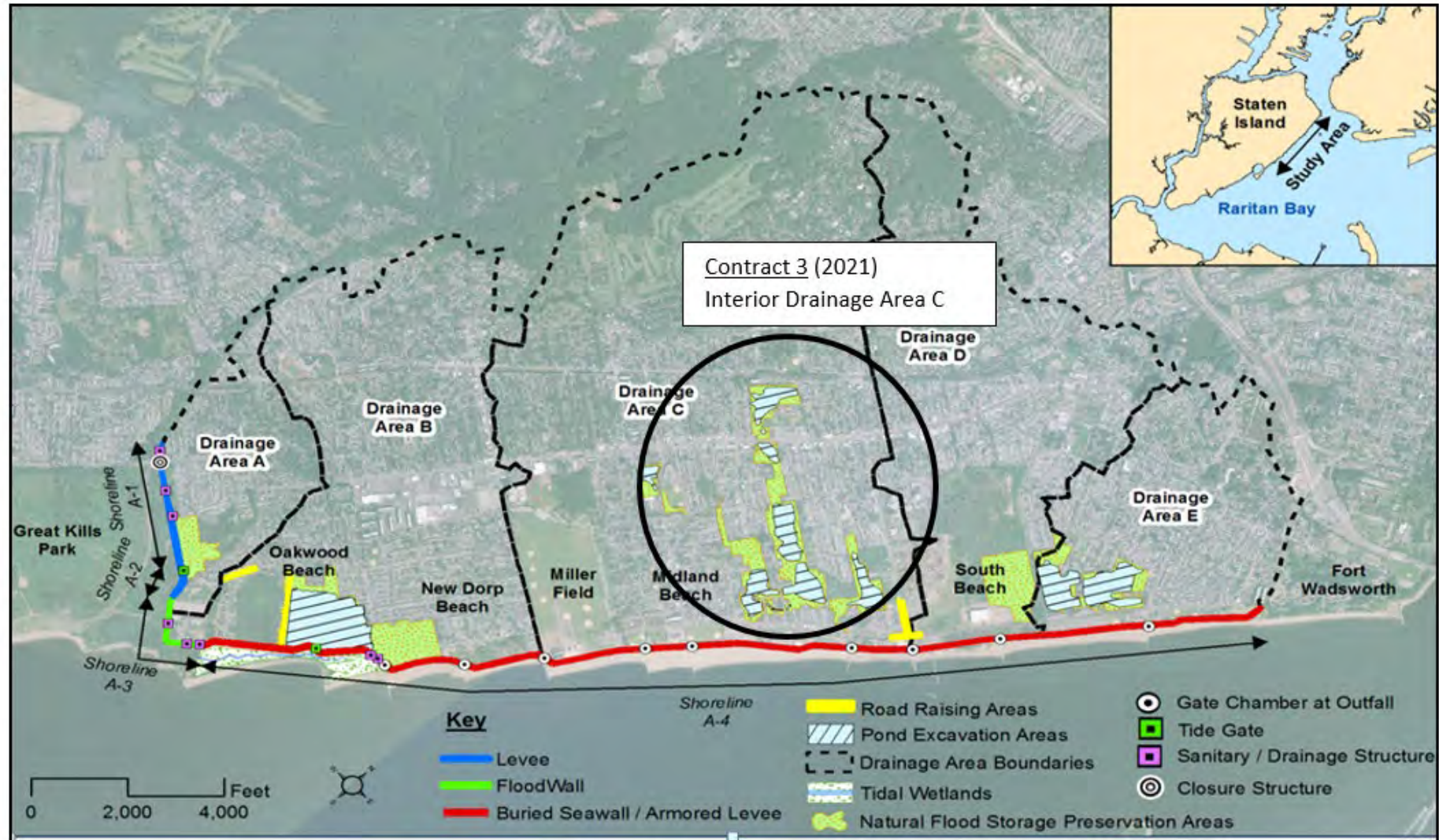



@ New Creek Area



Combines NYCDEP and Corps efforts

- NYCDEP Bluebelt construction
- Corps excavated ponds

NYCDEP - Bluebelt

Last Chance Pond (NC-11/12) Hylan
Under construction; completion 2021

Pond 7 (NC-13/14) Hylan/Mason Ave
Contract award in 2020

Pond 4 (NC-16) Mason/Olympia Blvd
Construction to start late 2019

Midland Pond (NC-6) Midland/Lincoln
Contract award in 2022



Corps - Interior Drainage Area C

Excavation of 3 Ponds below Olympia

- Pond 1 (NC-17)
- Pond 2 (NC-18/19)
- Pond 3 (NC-9/10)

- 40 Acres, excavate 170,000 cy

- Replant & seed pond with native wetland vegetation





CONTRACT #4 – LEVEE, HYLAN BLVD ROAD CLOSURE GATE, TIDE GATE GREAT KILLS PARK & HYLAN BLVD AWARD 2021

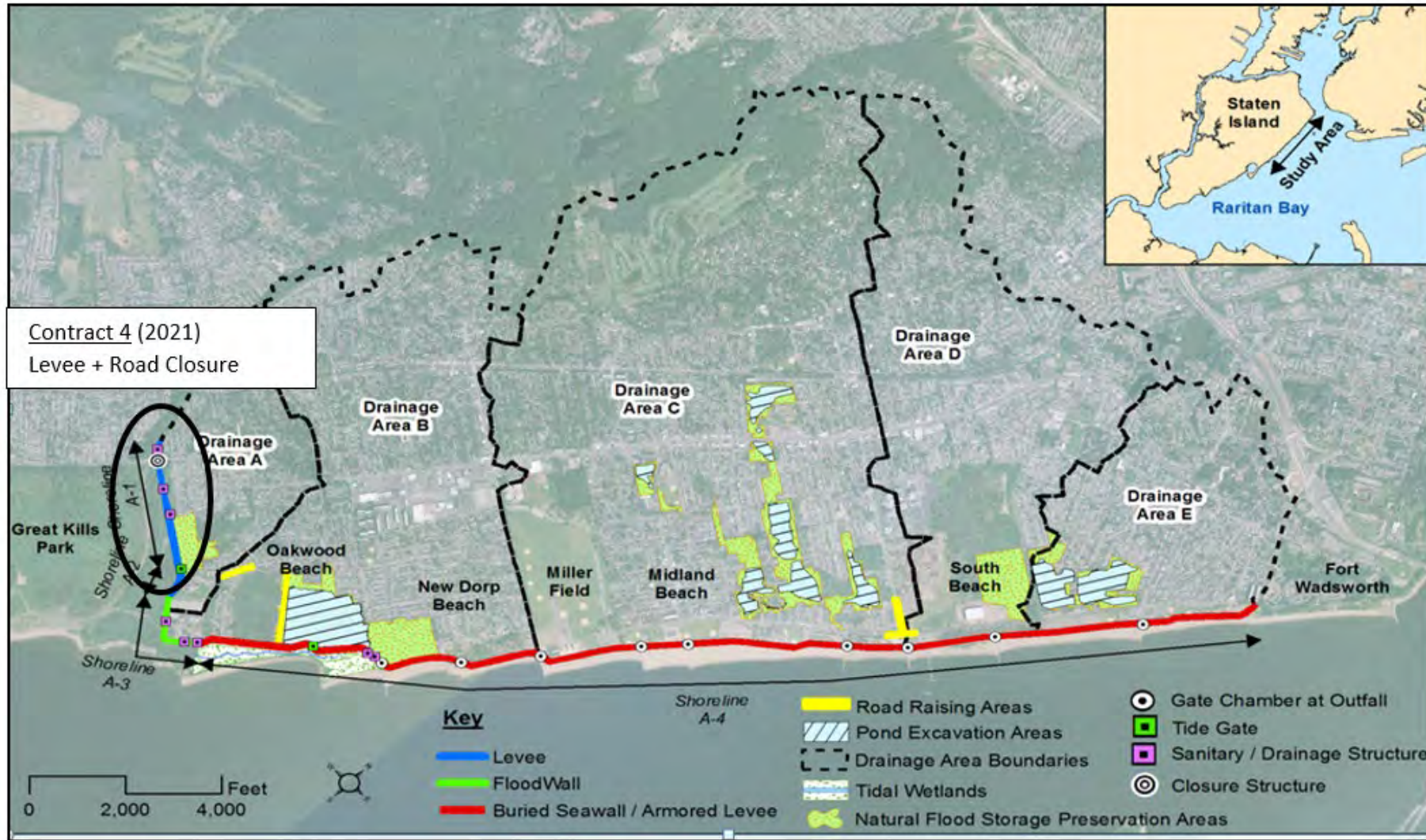



@ Great Kills Park and Hylan Blvd



Hylan Blvd Road Closure Gate, Levee, Tide Gate



Levee - Hylan Blvd to Treatment Plant

- 3,400 ft earthen levee
- Ties into floodwall contract
- Maintenance access ramp

Tide gate on Oakwood Creek

- Three 5'x5' gates; maintain tidal system

Open space storage area (Area A)

- North of Oakwood Treatment Plant (17 acres)

Road Closure Roller Gate

- 100 ft long and 3.9 ft high
- Across Hylan Blvd
- Between Buffalo St & Currie Ave
- Close during extreme events

Top of Levee +16.9 ft NAVD88

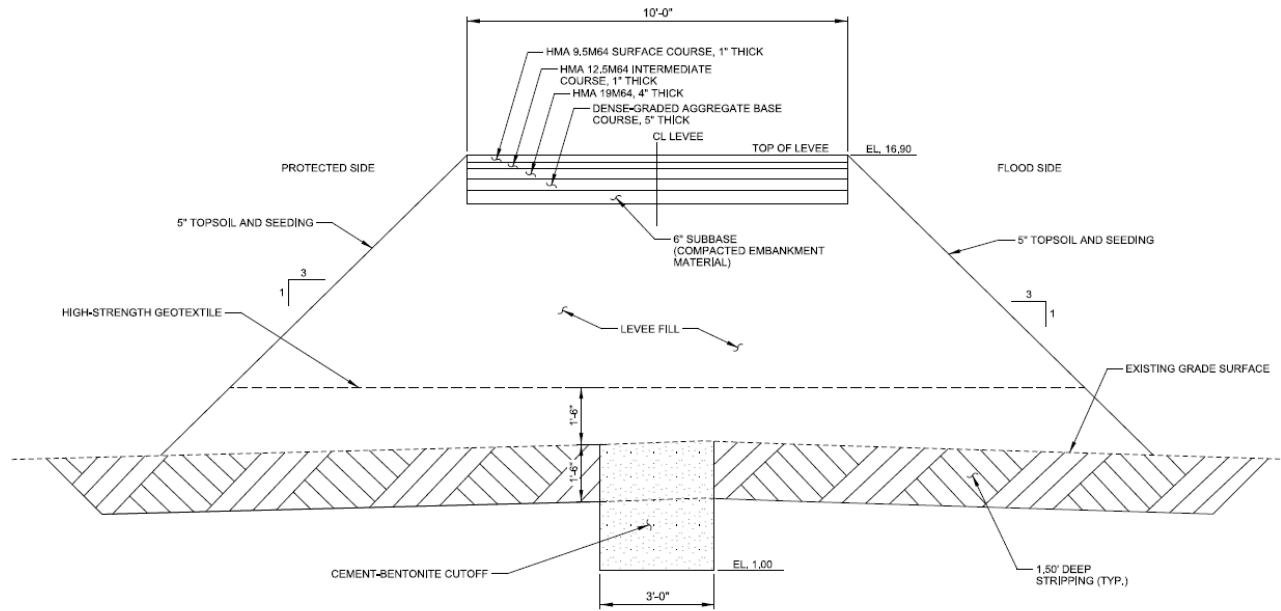

Sample Levee



Top of Roller Gate +16.9 ft NAVD88

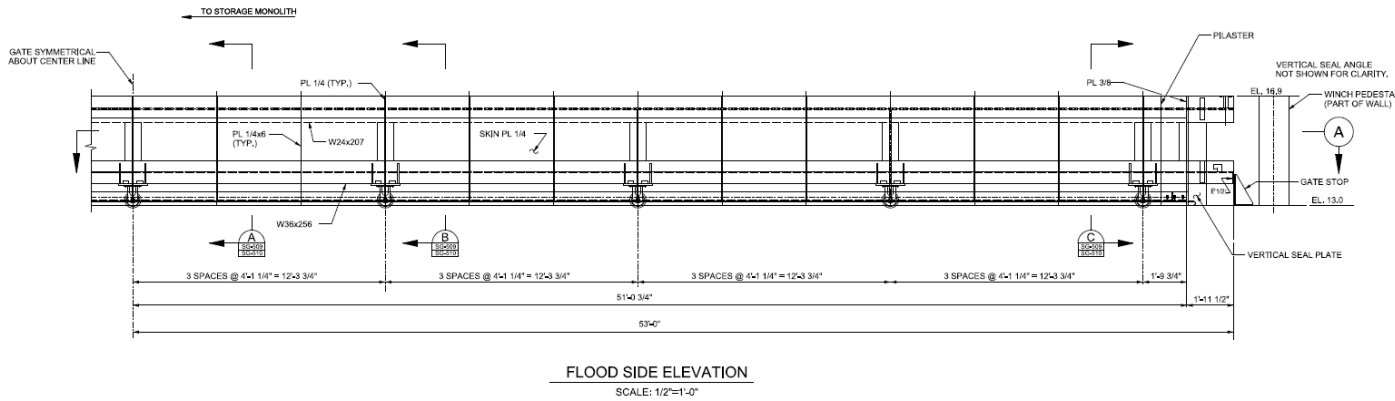

LEVEE ALIGNMENT - HYLAN BLVD ROLLER GATE
EXISTING STORM RE-ROUTING

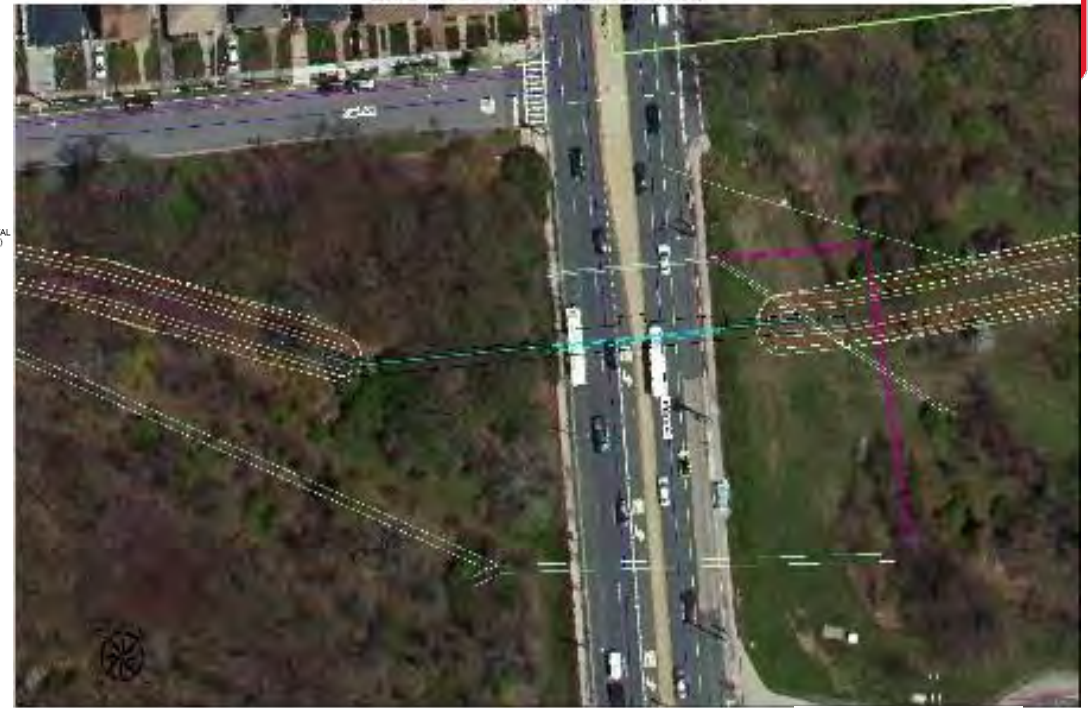

Sample Roller Closure Gate





Sample Roller Closure Gate



CONTRACT #5 – BURIED SEAWALL, PROMENADE, INTERIOR DRAINAGE AREA B, TIDAL WETLANDS OAKWOOD BEACH TO MILLER FIELD AWARD 2021

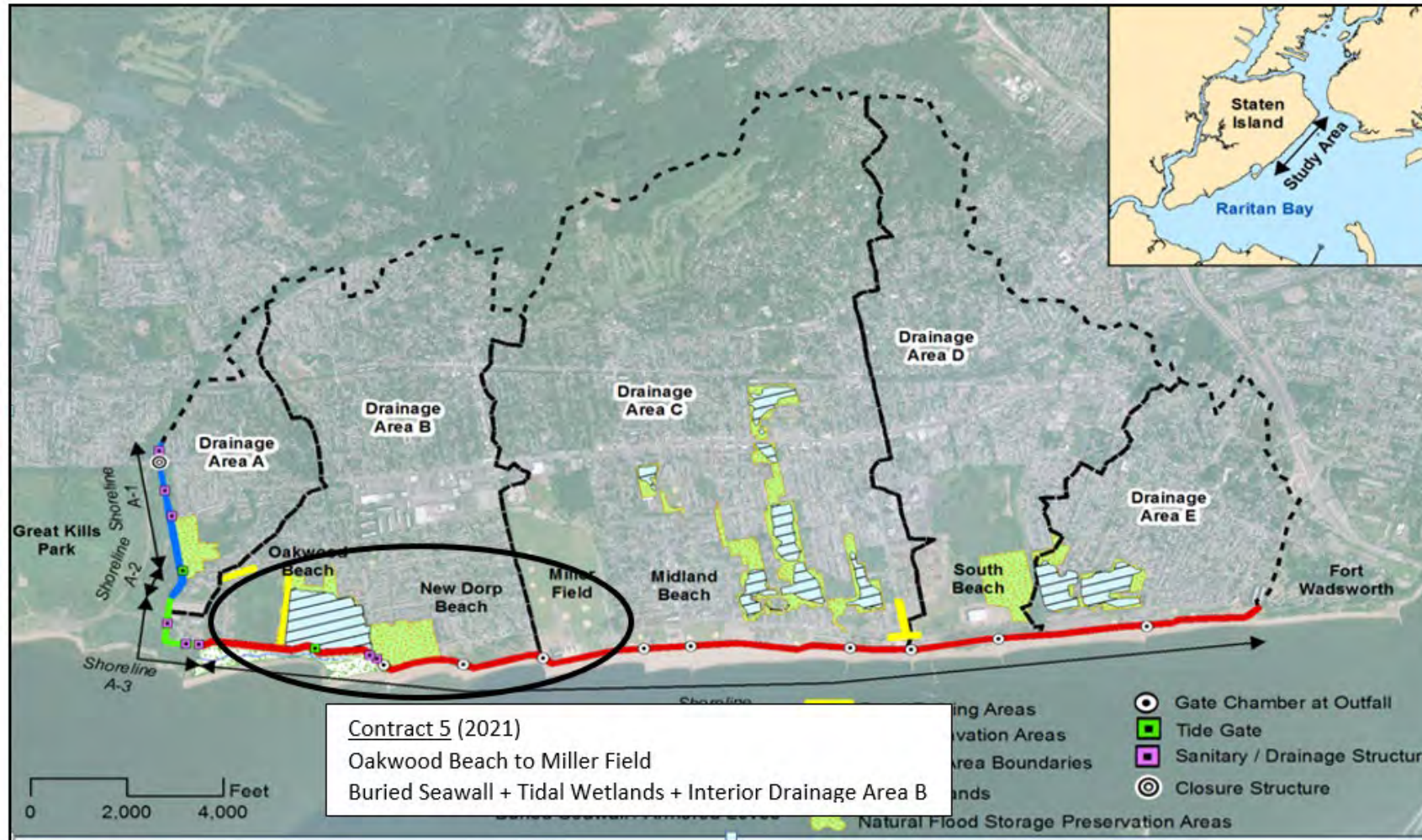

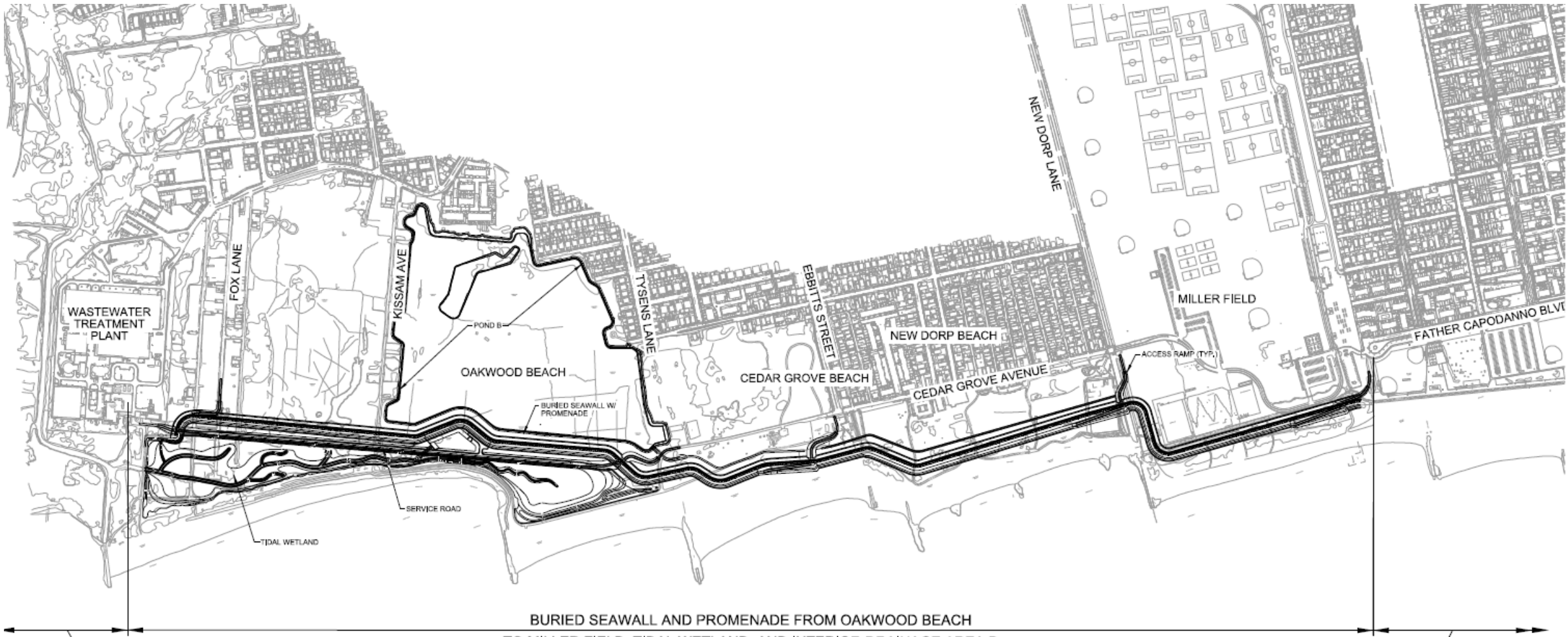

BURIED SEAWALL AND PROMENADE FROM OAKWOOD BEACH TO MILLER FIELD, TIDAL WETLAND, AND INTERIOR DRAINAGE AREA B

FLOODWALL AT OAKWOOD BEACH WASTE WATER TREATMENT PLANT (NIC)

BURIED SEAWALL AND BOARDWALK FROM MIDLAND BEACH TO FORT WADSWORTH (NIC)



@ Oakwood Beach to Miller Field



OAKWOOD TO MILLER FIELD – PROJECT FEATURES

- Buried Rock Seawall, with promenade
- 2 Tide Gates
- Storm water Outfall Gates
- Excavated Pond (Area B) + Open space storage areas
- Tidal Wetlands
- Miller Field Cultural Mitigation, Fire Tower, Memorial
- Removal of existing Oakwood Beach Tide Gate



Buried Rock Seawall with promenade, from Floodwall Contract thru Miller Field; 9,400 ft., covered with sand, planted with dune grass



Top of Seawall
+21.4 ft NAVD88

Top of Promenade
+23.4 ft NAVD88

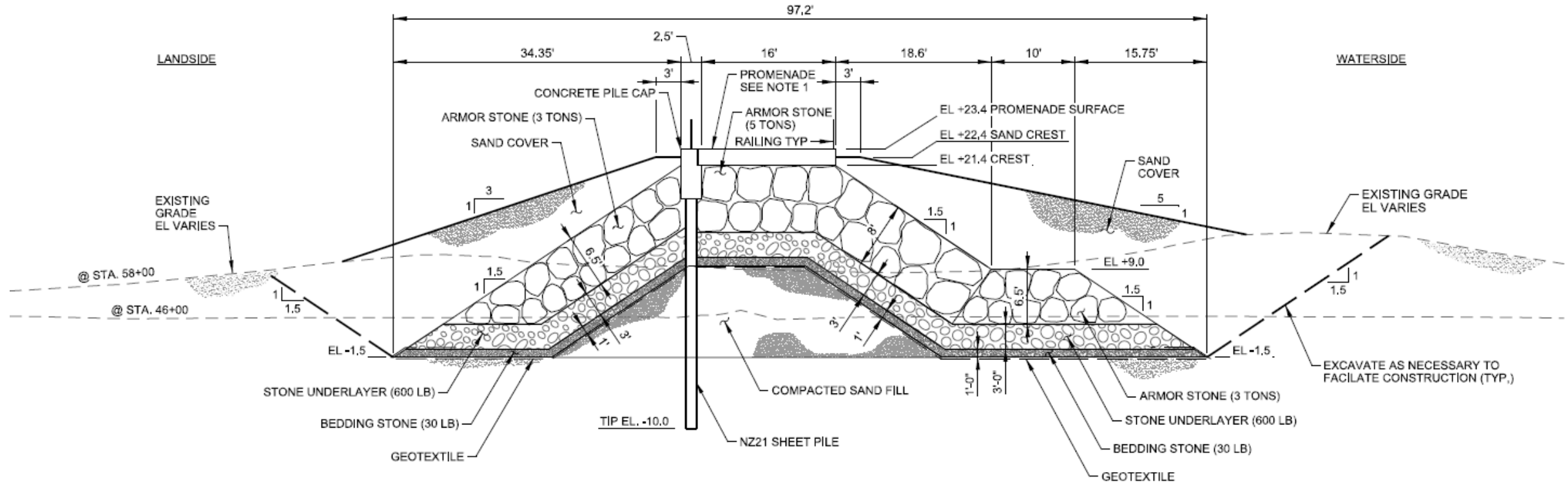

F2

CEDAR GROVE - TYPICAL SECTION (STA 45+75 - 63+80)

SCALE: 3/32" = 1'-0"

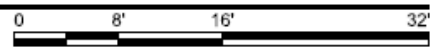



@ Oakwood Beach to Miller Field



2 Tide Gates

- near Kissam Ave
- allows interior drainage out

Gate Chambers on existing stormwater outfalls

- Tysens, Ebbitts, New Dorp
- Closed during storm events
- Normally open to allow interior drainage out

Excavated Pond

- east of Kissam Ave (48 acres)

Open space storage areas

- Cedar Grove, New Dorp



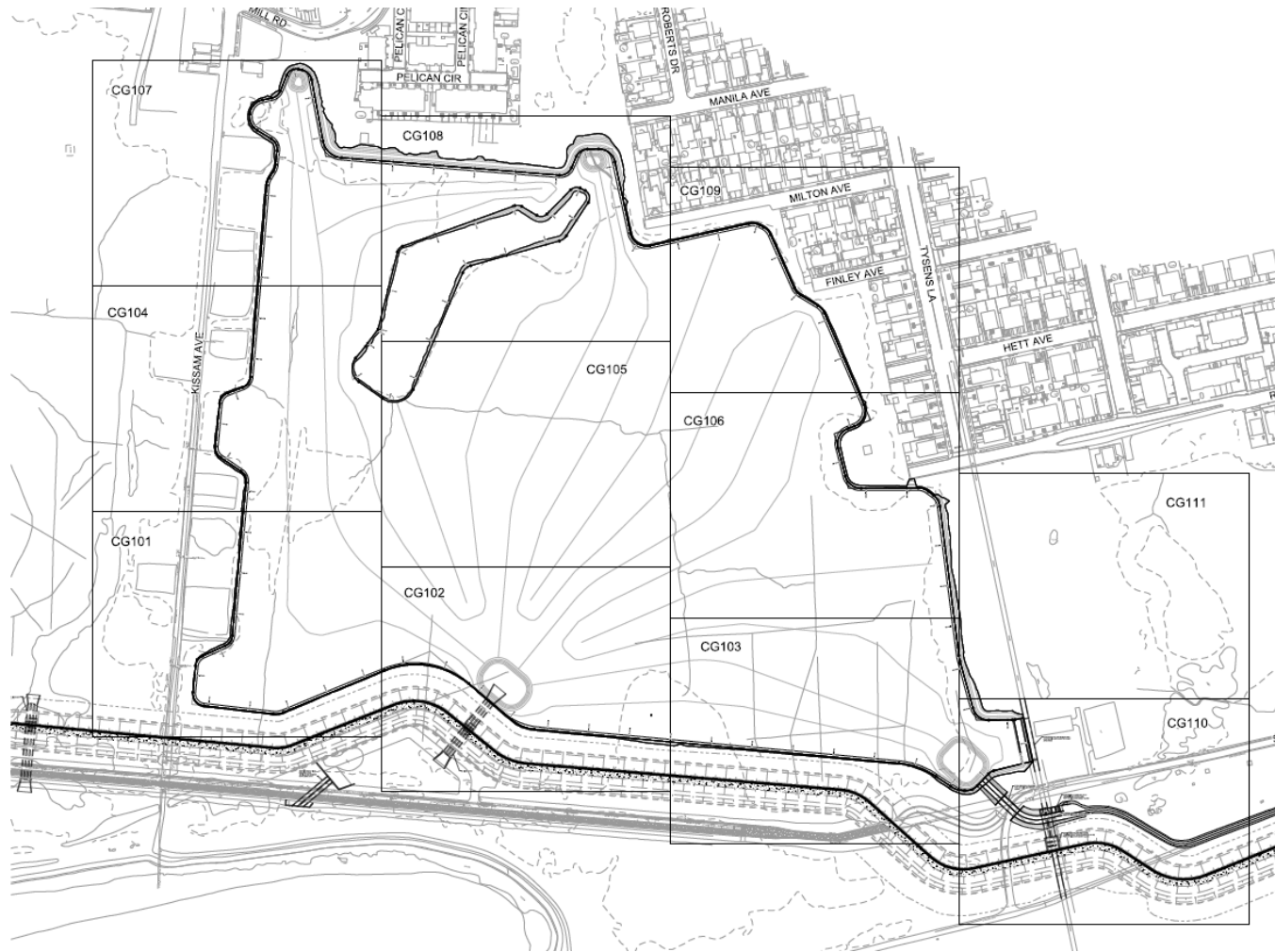

Interior Drainage Area B

Excavated Pond

- 48 acres, excavate 125,000 cy

Drainage Structures

- Tide gate on Oakwood Creek
- Into Tysens Lane outfall

- Replant & seed pond with native wetland vegetation

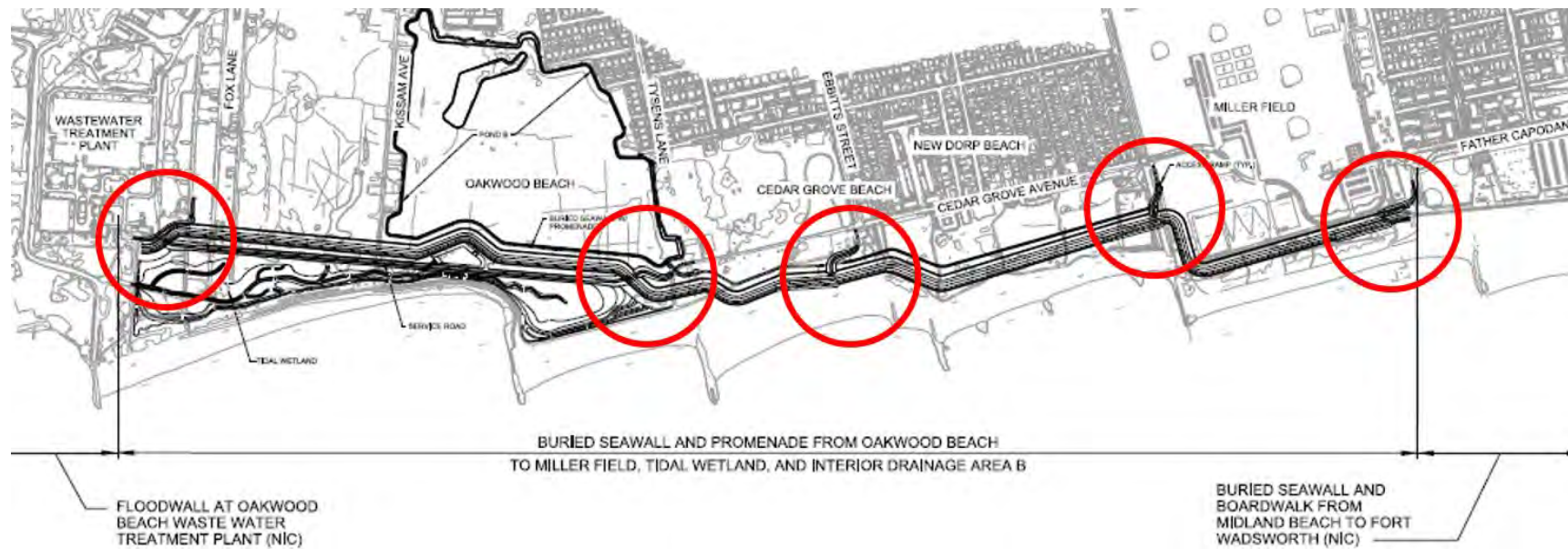

Sample Access ramps

- Tarlton St
- Tysens Ave
- Ebbitts St
- New Dorp Lane
- Miller Field

Sewer access

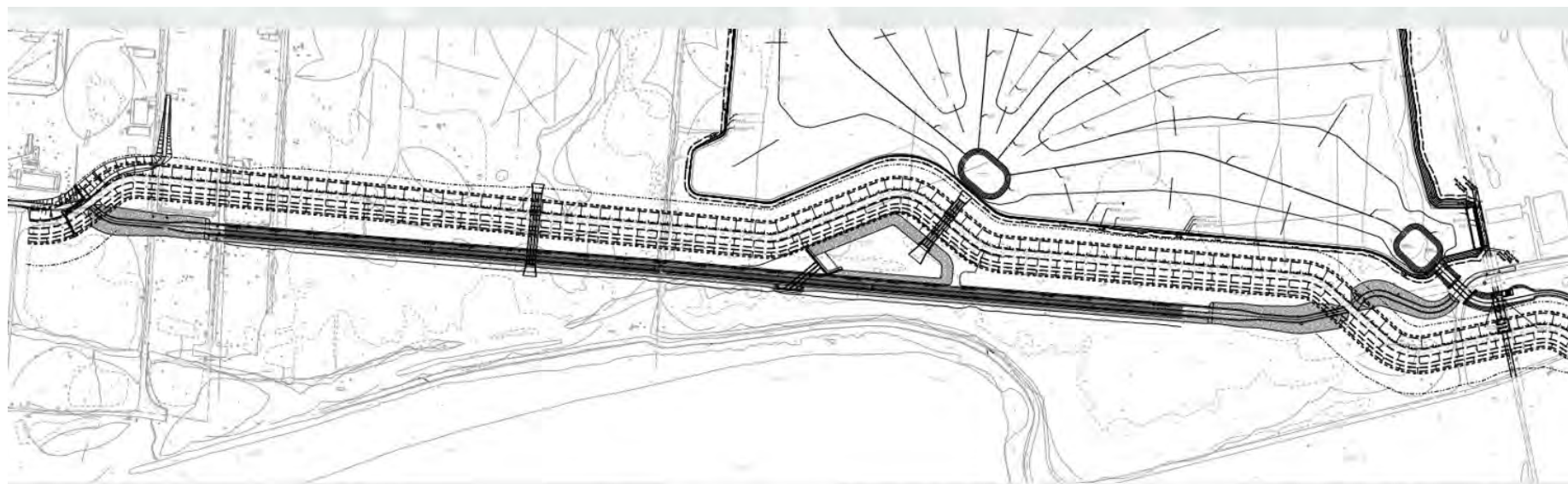

Tidal Wetlands

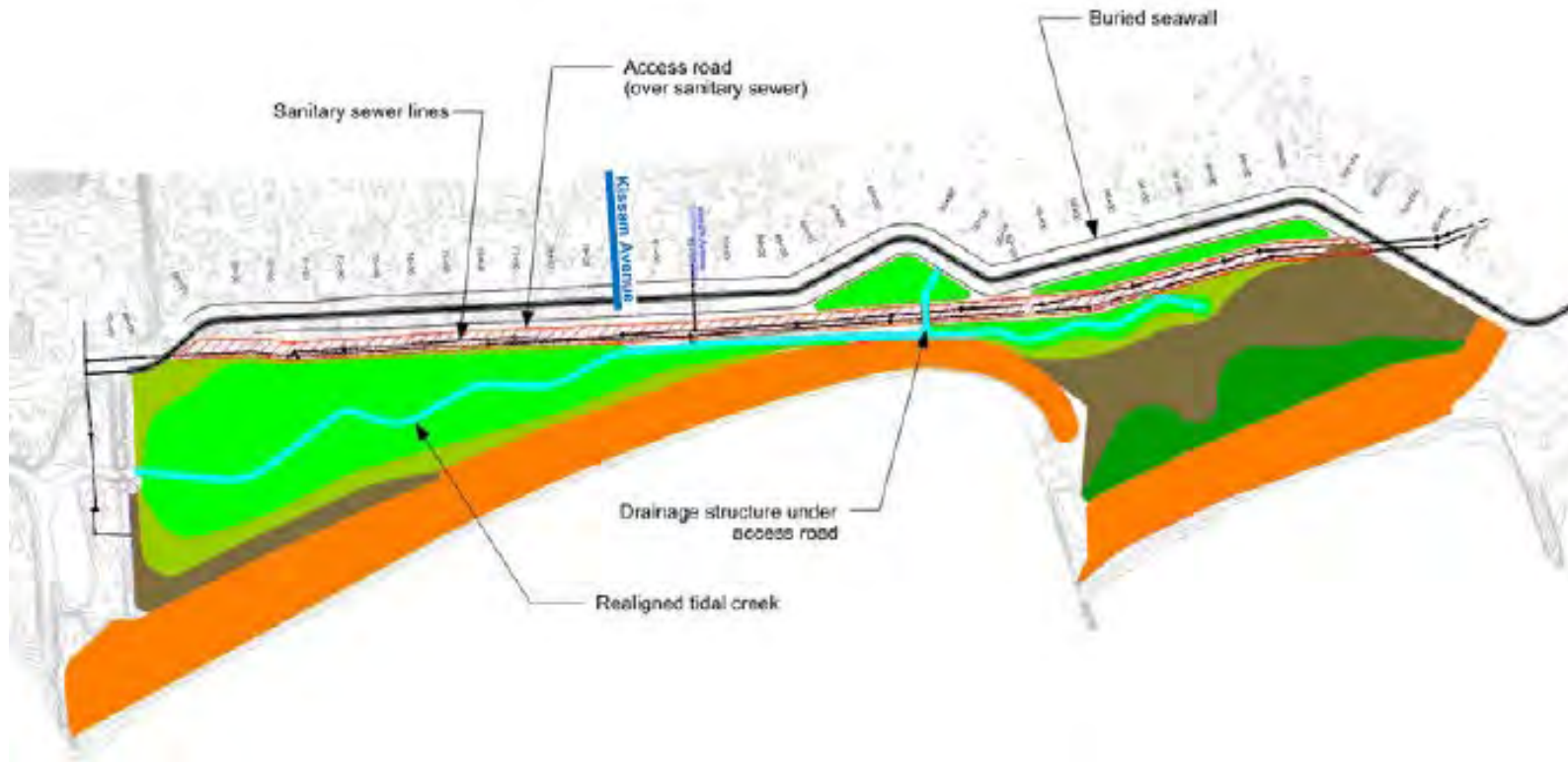

- To be constructed on ocean side of buried seawall
- from Fox Lane to Tysens
- Mosaic of habitats
 - low and high marsh
 - tidal creek
 - salt marsh
 - upland dune grasses
 - maritime shrub
 - maritime forest



- Relocate Memorial to new location
- Remove Fire Tower, complete cultural documentation
- Cultural Mitigation for view shed impacts to Army Historic District; NYSHPO

Buried Seawall along Miller Field



CONTRACT #6 – BURIED SEAWALL, NEW BOARDWALK MIDLAND BEACH TO FORT WADSWORTH AWARD 2022

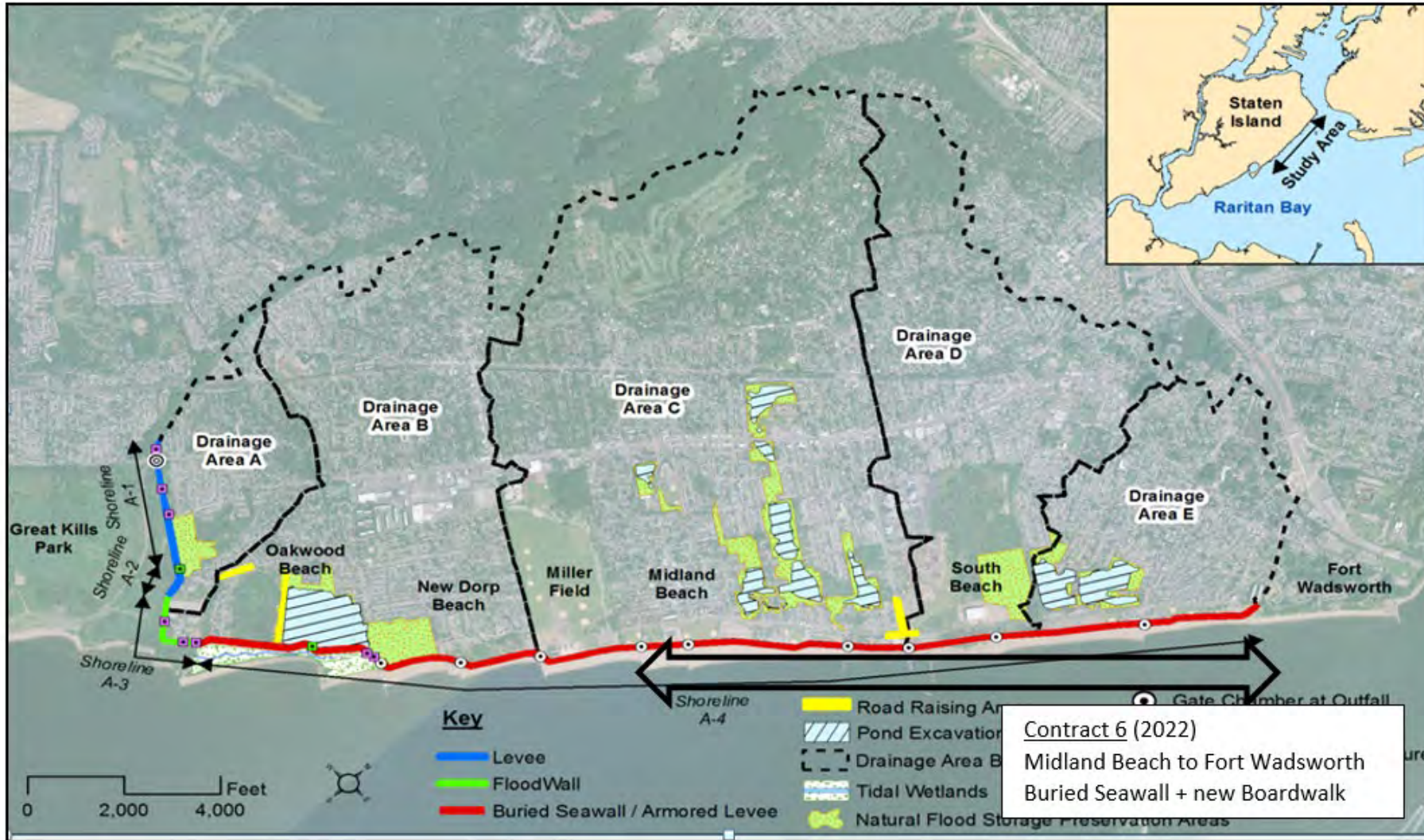



@ Midland Beach to Fort Wadsworth

- Buried Rock Seawall
New Boardwalk, new access ramps & stairs
- Gate Chambers on existing Storm Water Outfalls
 - Greely, Midland, Naughton, Seaview, Quintard, Sand Lane
- Construction Staging Areas; to be restored

Design coordination underway

- Design features of new boardwalk, new access locations (ramps/stairs)
- Project integration with existing Parks facilities
- Design accommodations to incorporate City future storm water plans
- Staging areas to be utilized during entire construction



Top of Seawall
+21.4 ft NAVD88

Top of Boardwalk
+23.4 ft NAVD88



CONTRACT #7 – MILLER FIELD OFFSET

AWARD 2021



- Offset the project's impact to the visitor experience at Miller Field
- Enhancement of swamp white oak forest and public access
- Coordination with NPS

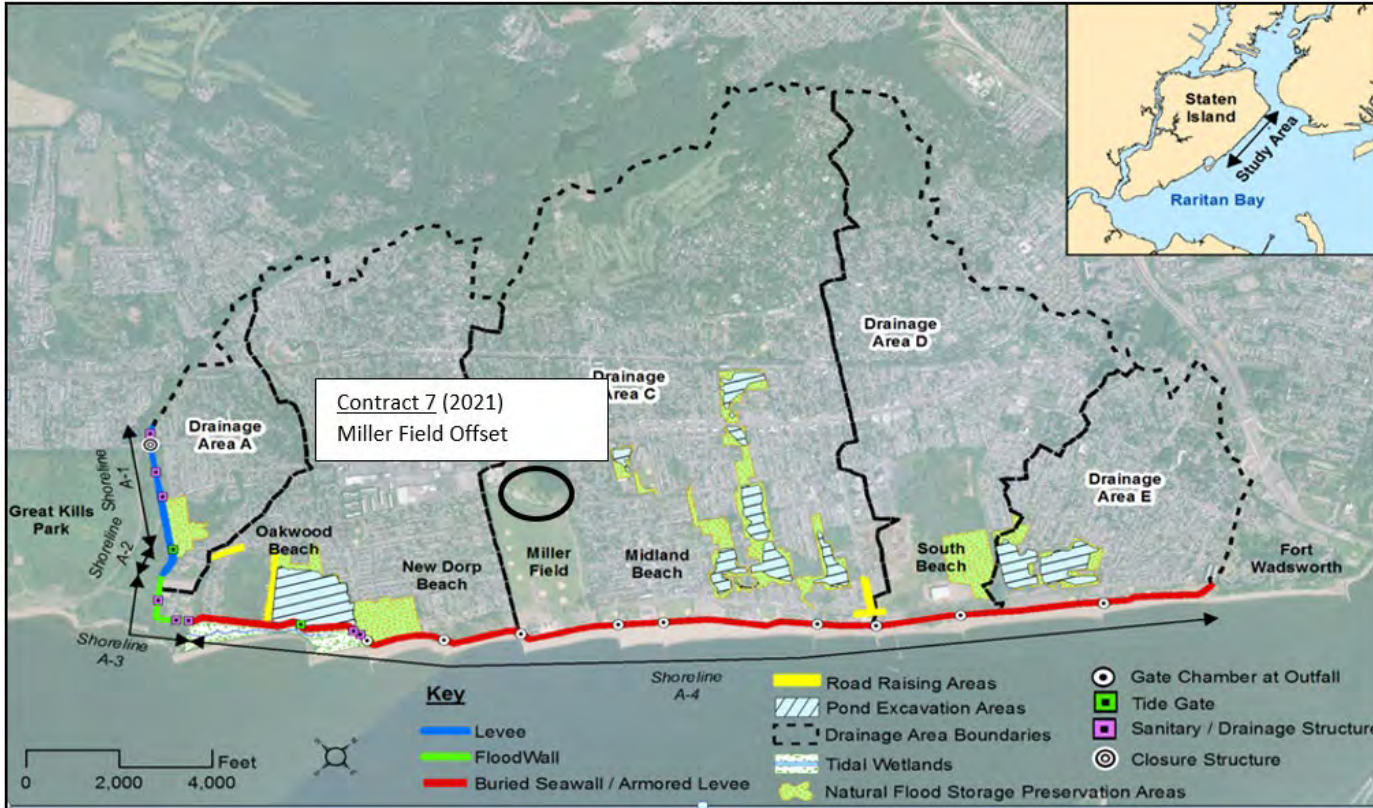



DESIGN EFFORTS UNDERWAY



- Existing Utility Lines, Sanitary Lines, etc
- Tree Restitution
- Construction Methodology for seawall, boardwalk
- Public Access during project construction to beaches, boardwalk, Parks facilities, staging areas
- Design packages 30%, 60%, 90%, 100%, contract advertisement
- Required Technical Reviews Corps value engineering, Corps technical reviews, NYS & NYC reviews, Independent External Peer Reviews
- Real Estate Acquisitions over 700+ parcels required for project



Corps Risk Assessment & Coordination with FEMA National Flood Insurance Program

- Corps prepares initial risk assessment
- Evaluates life and economic consequences, hazard curves, potential failure mode analysis, annual probability of inundation
- Results refine project designs and provide initial recommendations for NFIP accreditation
- Assessment underway (Design + Post Construction)
- Continuing coordination with FEMA

SEA LEVEL CHANGE ADAPTABILITY

- Project features (Road Closure Gate, Levee, Floodwall, Tide Gates, Buried Seawall) are all designed for potential future adaptability
- Can increase project height by additional 3 feet





RESIDUAL FLOODING

- Project will significantly reduce interior flooding from current existing conditions
- Low level damages from interior run-off flooding in some parts of the project area will continue even with the project in place
- There still exists potential for occurrences where coastal storm levels exceed the design level of the project
- **RESIDENTS MUST CONTINUE TO FOLLOW NYC EVACUATION ORDERS AND PROTOCOLS TO HELP DECREASE RISKS TO LIFE SAFETY IN THE EVENT OF A SEVERE COASTAL STORM**



CONSTRUCTION CONTRACTS - SUMMARY

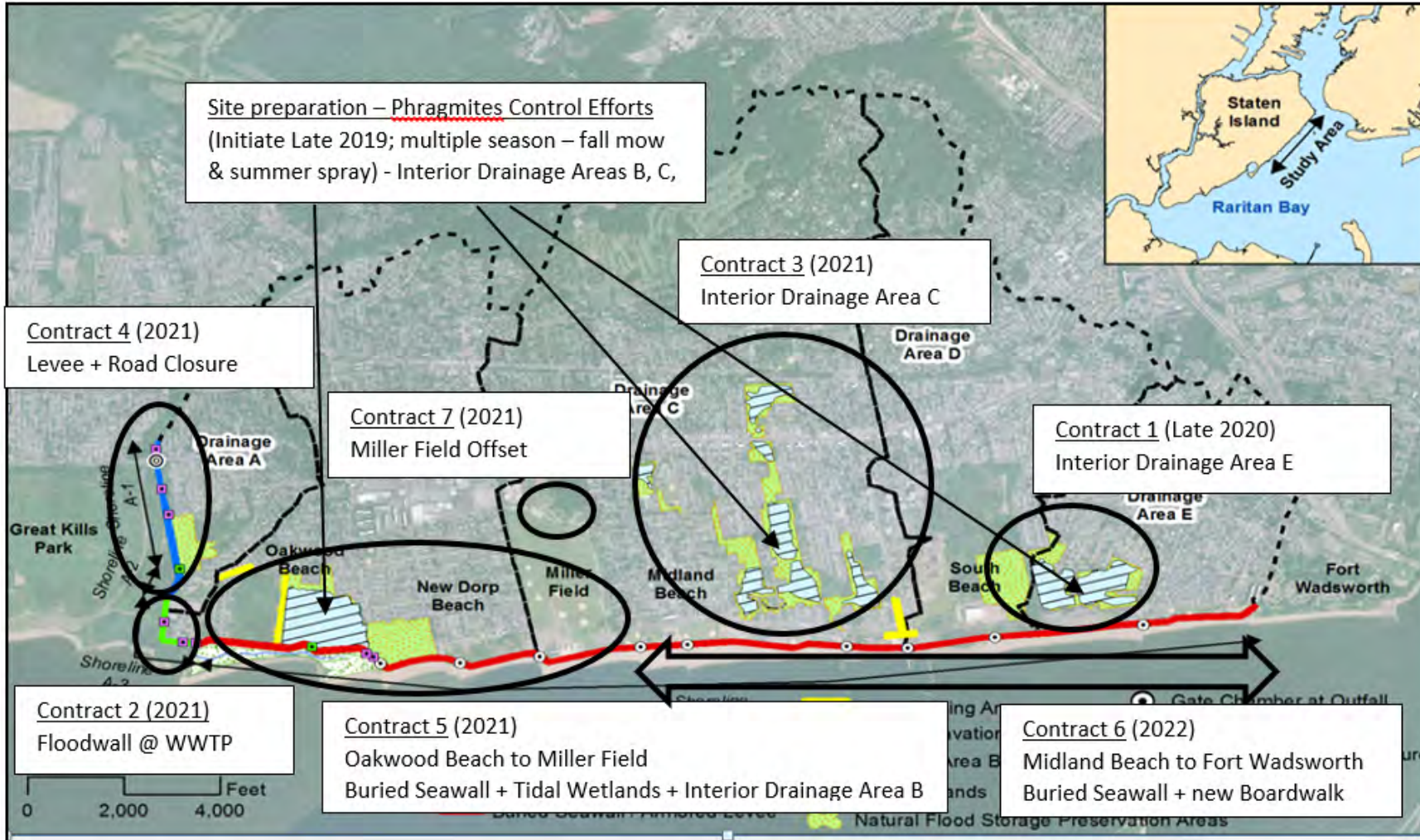

Contract Awards

2020

- Interior Area E

2021

- Floodwall
- Interior Area C
- Levee & Road Gate
- Oakwood to Miller Field (Area B, Tidal Wetlands)

2022

- Midland to Ft Wadsworth (boardwalk)



**US Army Corps
of Engineers**
New York District
BUILDING STRONG®



NYC



**Environmental
Protection**



NYC Parks



Continuous coordination with project sponsors, stakeholders, congressional interests, public

Additional information will be provided as we progress each contract towards construction

This presentation is available on the U.S. Army Corps of Engineers, New York District website for viewing and download:

www.nan.usace.army.mil