

STAKE OUT			
A-C	6'5"	B-C	9'9-1/2"
A-D	8'11-1/4"	B-D	7'-1/2"
A-E	21'8-1/4"	B-E	19'2-3/4"
A-F	19'3-1/8"	B-F	22'2"
A-G	18'10-3/4"	B-G	23'3-7/8"
A-H	17'10-3/4"	B-H	25'-1/4"
A-I	16'1-5/8"	B-I	24'-5/8"
A-J	6'6-1/2"	B-J	15'11-1/2"
A-K		B-K	
A-L		B-L	
A-M		B-M	

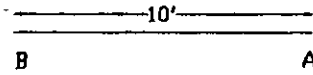

24 BAKER ST. P.O. BOX 100, HASTINGS ON KOL - 1Y0
 705-696-2385, 1-800-465-3433, FAX: 705-696-1922

14' X 28' R.H. CALIFORNIAN

QTY.	LENGTH	RADIUS	TYPE
2	8'	7'	PLAIN
1	8'	7'	RETURN
1	1'-6"	7'	PLAIN
1	3'-6"	7'	PLAIN
1	4'6"	4'	REVERSE
1	10'	NA	RETURN
1	8'	NA	SKIMMER
1	7'	NA	PLAIN
1	6'	NA	PLAIN
1	3'	NA	PLAIN
2	3'-2"	2'	CORNER
13	-	NA	A-FRAME
1	-	NA	N&B PKG
			S.A. 341 sq.ft.
			PER: 73'10"
1428CALC			DATE: 23-05-01

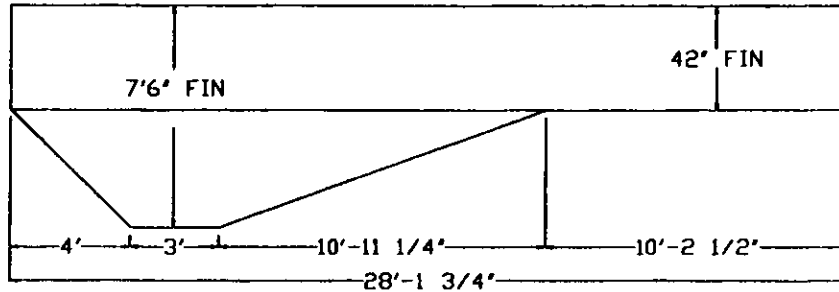

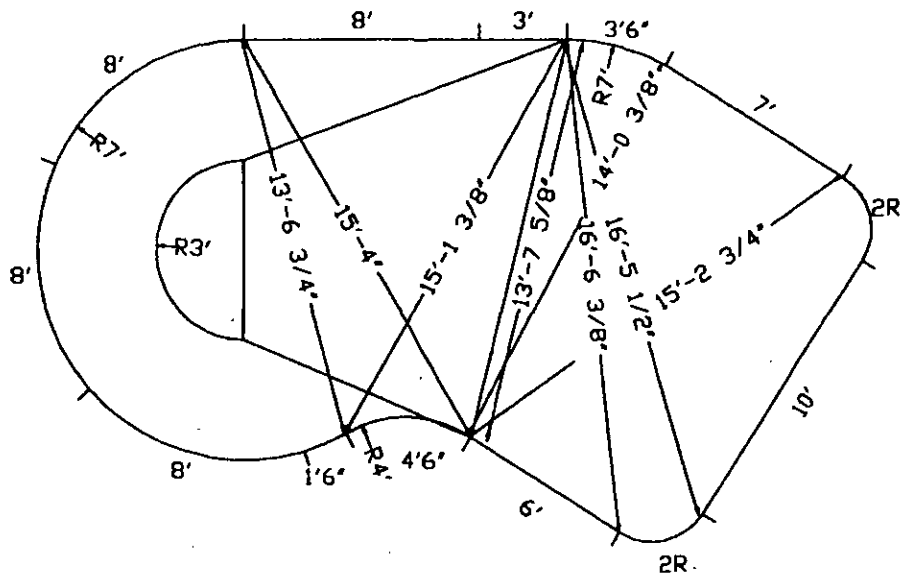
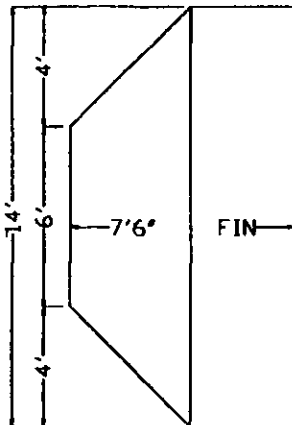

24 BAKER ST, P.O. BOX 100, HASTINGS ON KOL - 1Y0
 705-696-2385 1-800-465-3433 FAX 705-696-1922

14' X 28' R.H. CALIFORNIAN

QTY.	LENGTH	RADIUS	TYPE
2	8'	7'	PLAIN
1	8'	7'	RETURN
1	1'-6"	7'	PLAIN
1	3'-6"	7'	PLAIN
1	4'6"	4'	REVERSE
1	10'	NA	RETURN
1	8'	NA	SKIMMER
1	7'	NA	PLAIN
1	6'	NA	PLAIN
1	3'	NA	PLAIN
2	3'-2"	2'	CORNER
13	-	NA	A-FRAME
1	-	NA	N&B PKG
			S.A. 341 sq.ft.
			PER: 73'10"
1428CALC			DATE: 23-05-01

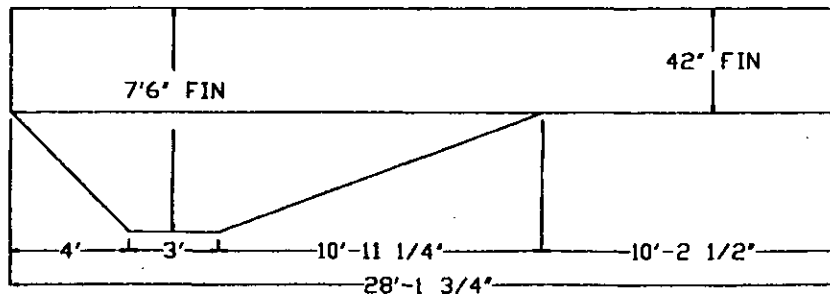

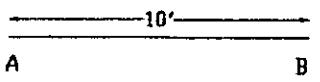
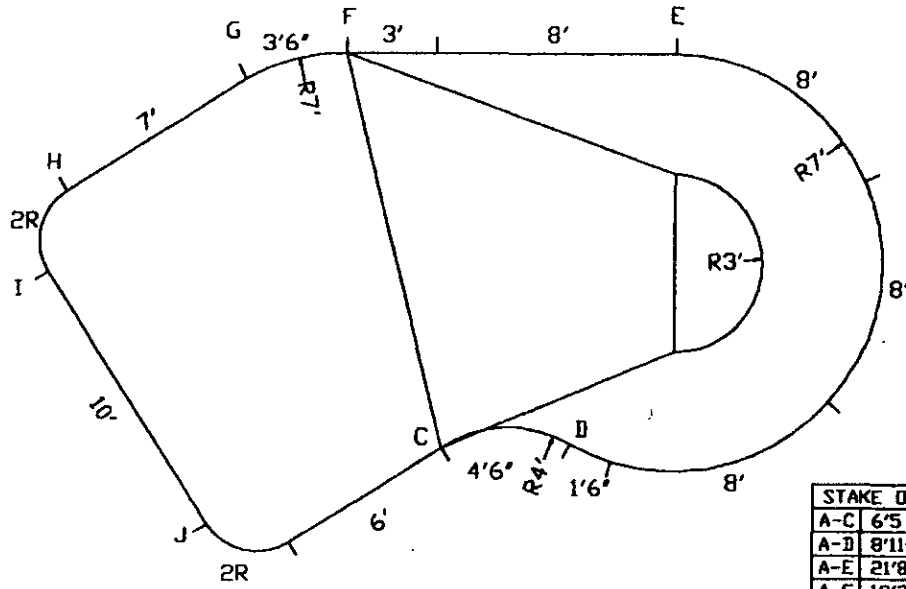

STAKE OUT			
A-C	6'5"	B-C	9'9-1/2"
A-D	8'11-1/4"	B-D	7'-1/2"
A-E	21'8-1/4"	B-E	19'2-3/4"
A-F	19'3-1/8"	B-F	22'2"
A-G	18'10-3/4"	B-G	23'3-7/8"
A-H	17'10-3/4"	B-H	25'-1/4"
A-I	16'1-5/8"	B-I	24'-5/8"
A-J	6'6-1/2"	B-J	15'11-1/2"
A-K		B-K	
A-L		B-L	
A-M		B-M	

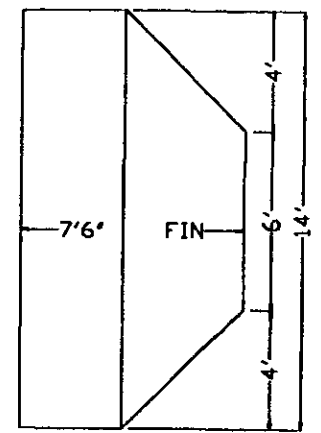

24 BAKER ST. P.O. BOX 100, HASTINGS ON KOL. 1YO
705-696-2385, 1-800-465-3433 FAX: 705-696-1922

14' X 28' L.H. CALIFORNIAN

QTY.	LENGTH	RADIUS	TYPE
2	8'	7'	PLAIN
1	8'	7'	RETURN
1	1'-6"	7'	PLAIN
1	3'-6"	7'	PLAIN
1	4'6"	4'	REVERSE
1	10'	NA	RETURN
1	8'	NA	SKINNER
1	7'	NA	PLAIN
1	6'	NA	PLAIN
1	3'	NA	PLAIN
2	3'-2"	2'	CORNER
13	-	NA	A-FRAME
1	-	NA	N&B PKG
			S.A.: 341 sq.ft.
			PER: 73'10"
1428CALC			DATE: 23-05-01

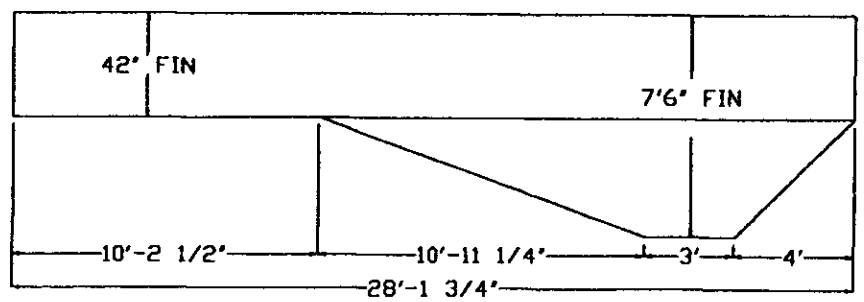

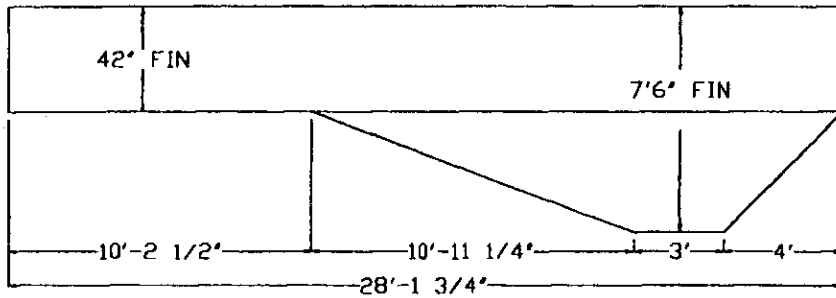
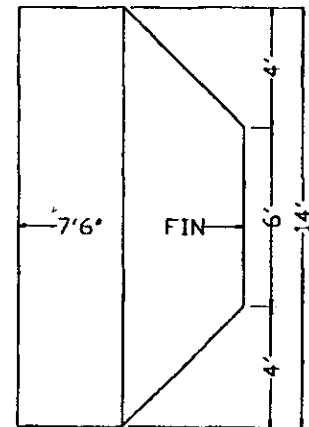
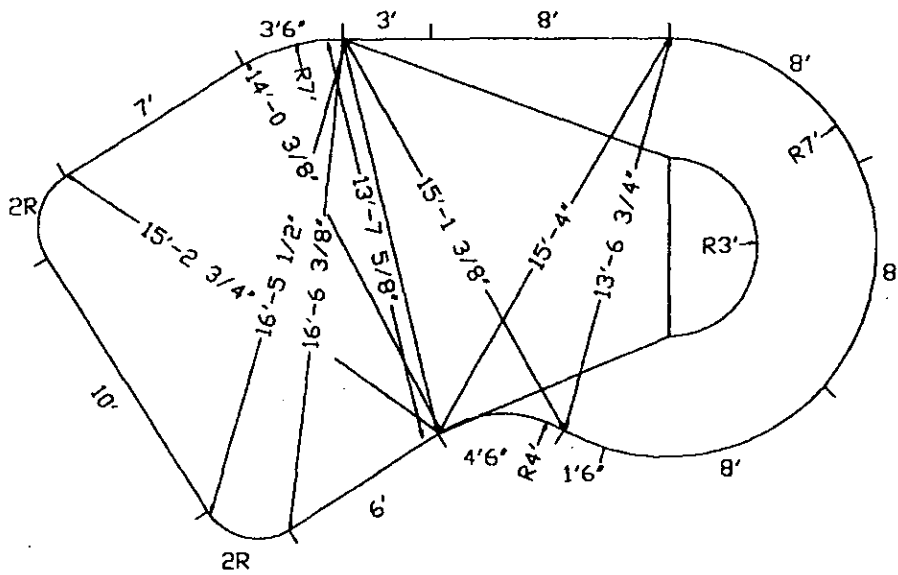

24 BAKER ST, P.O. BOX 100, HASTINGS DN, KOL-1YO
 705-696-2385, 1-800-465-3433, FAX: 705-696-1922

14' X 28' L.H. CALIFORNIAN

QTY.	LENGTH	RADIUS	TYPE
2	8'	7'	PLAIN
1	8'	7'	RETURN
1	1'-6"	7'	PLAIN
1	3'-6"	7'	PLAIN
1	4'6"	4'	REVERSE
1	10'	NA	RETURN
1	8'	NA	SKIMMER
1	7'	NA	PLAIN
1	6'	NA	PLAIN
1	3'	NA	PLAIN
2	3'-2"	2'	CORNER
13	-	NA	A-FRAME
1	-	NA	N&B PKG
			S.A. 341 sq.ft.
			PER: 73'10"
1428CALC			DATE: 23-05-01

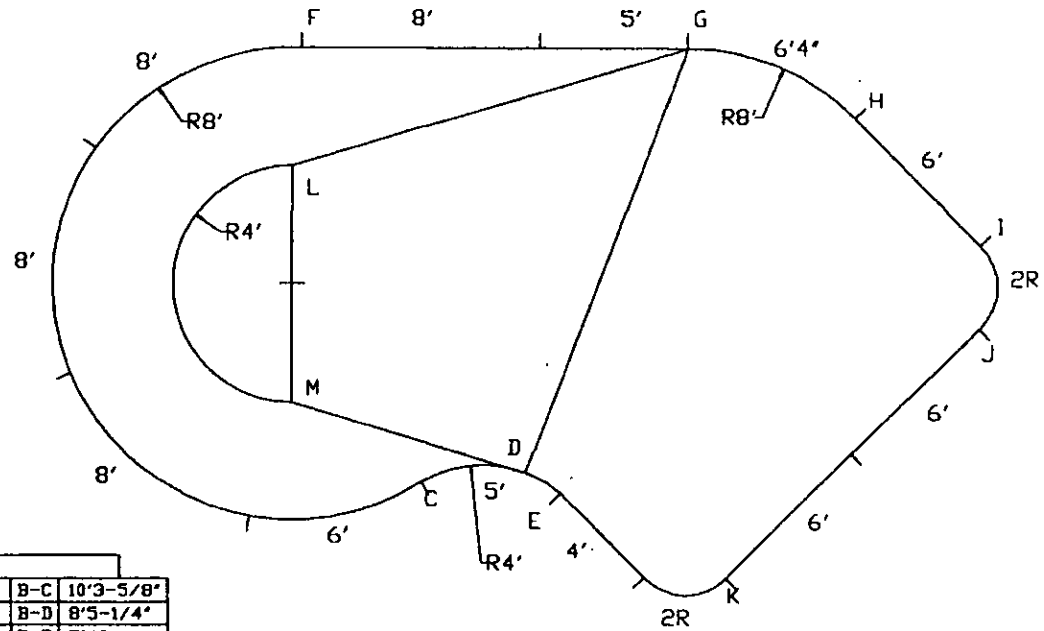
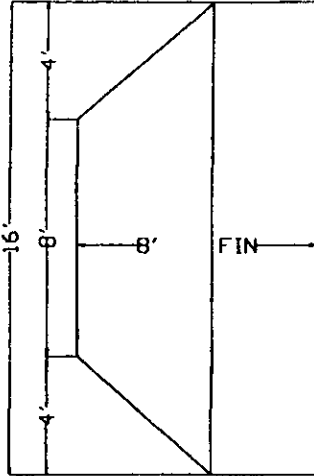

STAKE OUT			
A-C	7'7"	B-C	10'3-5/8"
A-D	9'7-1/2"	B-D	8'5-1/4"
A-E	9'11"	B-E	7'4"
A-F	21'10-3/4"	B-F	24'8-1/4"
A-G	24'8-1/4"	B-G	21'10-3/4"
A-H	25'11-3/4"	B-H	20'9"
A-I	26'3-1/4"	B-I	19'-1/4"
A-J	24'8-3/4"	B-J	16'10"
A-K	13'5-5/8"	B-K	4'10-1/2"
A-L	17'10-7/8"	B-L	21'4-1/4"
A-M	9'11-3/4"	B-M	15'4"

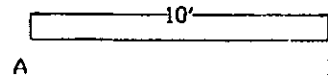

24 BAKER ST., P.O. BOX 100, HASTINGS ON KOL - 1Y0
 705-696-2385, 1-800-465-3433, FAX: 705-696-1922

16'X32' R.H. CALIFORNIAN

QTY.	LENGTH	RADIUS	TYPE
1	8'0"	8'0"	RETURN
2	8'0"	8'0"	PLAIN
1	6'4"	8'0"	PLAIN
1	6'0"	8'0"	PLAIN
1	5'0"	4'0"	REVERSE
2	3'2"	2'0"	CORNER
1	8'0"	NA	SKIMMER
1	6'0"	NA	RETURN
2	6'0"	NA	PLAIN
1	5'0"	NA	PLAIN
1	4'0"	NA	PLAIN
10	-	NA	A-FRAME
1	-	NA	N&B PKG
			S.A. 428 sq.ft.
			PER: 82'8"
1632CALC			DATE: 09-11-00

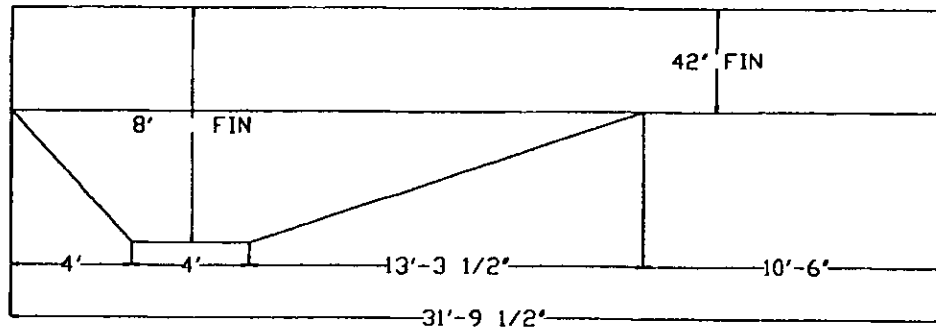

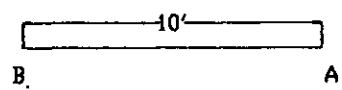
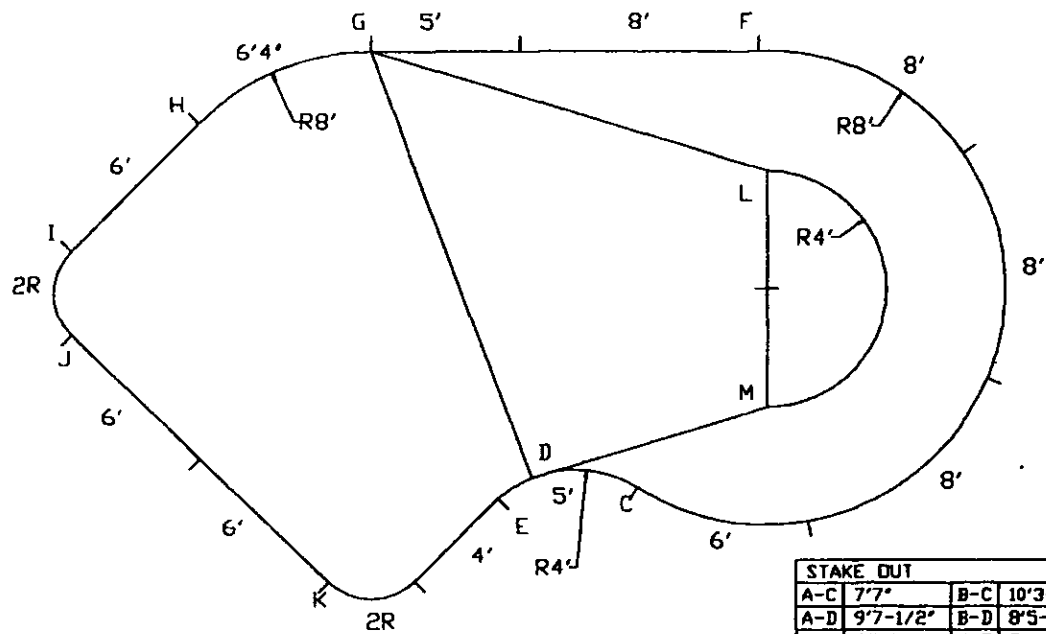

STAKE OUT			
A-C	7'7"	B-C	10'3-5/8"
A-D	9'7-1/2"	B-D	8'5-1/4"
A-E	9'11"	B-E	7'4"
A-F	21'10-3/4"	B-F	24'8-1/4"
A-G	24'8-1/4"	B-G	21'10-3/4"
A-H	25'11-3/4"	B-H	20'9"
A-I	26'3-1/4"	B-I	19'-1/4"
A-J	24'8-3/4"	B-J	16'10"
A-K	13'5-5/8"	B-K	4'10-1/2"
A-L	17'10-7/8"	B-L	21'4-1/4"
A-M	9'11-3/4"	B-M	15'4"

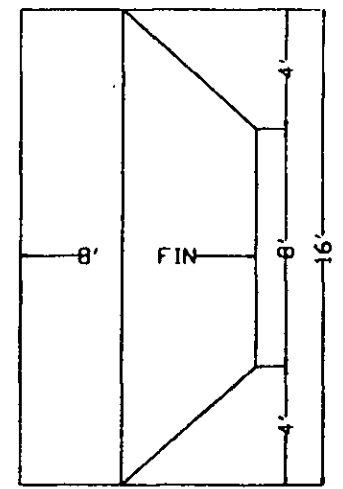

24 BAKER ST, P.O. BOX 100, HASTINGS DNKOL-1Y0
 705-696-2385, 1-800-463-3433, FAX: 705-696-1922

16'X32' L.H. CALIFORNIAN

QTY.	LENGTH	RADIUS	TYPE
1	8'0"	8'0"	RETURN
2	8'0"	8'0"	PLAIN
1	6'4"	8'0"	PLAIN
1	6'0"	8'0"	PLAIN
1	5'0"	4'0"	REVERSE
2	3'2"	2'0"	CORNER
1	8'0"	NA	SKIMMER
1	6'0"	NA	RETURN
2	6'0"	NA	PLAIN
1	5'0"	NA	PLAIN
1	4'0"	NA	PLAIN
10	-	NA	A-FRAME
1	-	NA	N&B PKG
			S.A: 428 sq.ft.
			PER: 82'8"
1632CALC			DATE: 09-11-00

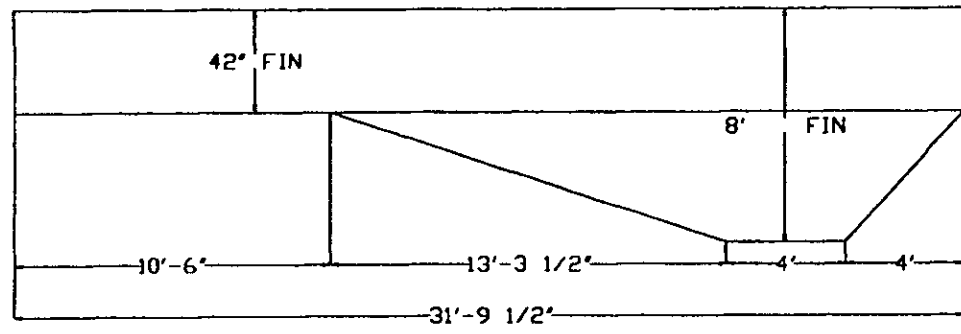

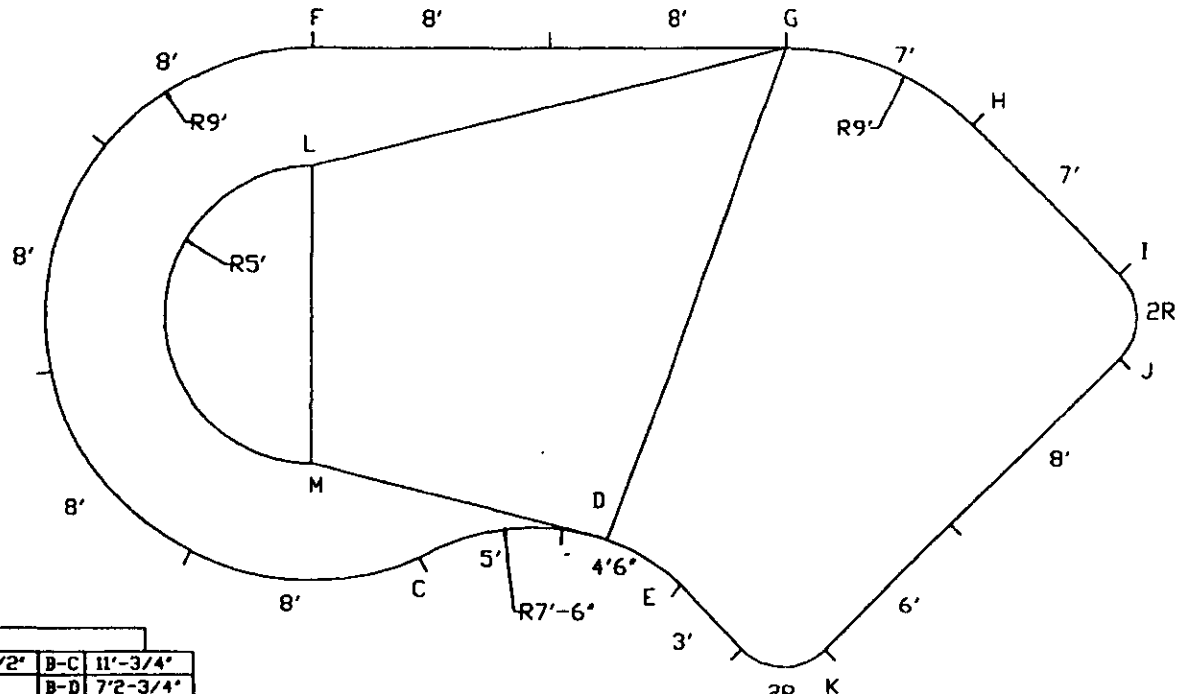
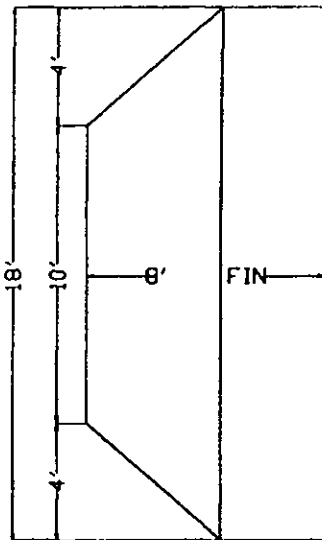

STAKE OUT			
A-C	5'11-1/2"	B-C	11'-3/4"
A-D	9'-7"	B-D	7'2-3/4"
A-E	10'-9"	B-E	5'-3/4"
A-F	23'4"	B-F	26'6-1/2"
A-G	26'6-1/2"	B-G	23'4"
A-H	28'2-1/2"	B-H	22'6-3/4"
A-I	28'10-1/4"	B-I	21'1-7/8"
A-J	27'3-1/4"	B-J	19'2"
A-K	14'8"	B-K	5'3"
A-L	19'4-1/2"	B-L	23'1-3/4"
A-M	9'7-1/2"	B-M	15'10-3/4"



24 BAKER ST, P.O. BOX 100, HASTINGS ON KOL - 1Y0
 705-696-2383, 1-800-465-3433, FAX: 705-696-1922

18'X36'R.H. CALIFORNIAN

QTY.	LENGTH	RADIUS	TYPE
1	8'0"	9'0"	RETURN
3	8'0"	9'0"	PLAIN
1	7'0"	9'0"	PLAIN
1	5'0"	7'6"	REVERSE
1	4'6"	7'6"	REVERSE
2	3'2"	2'0"	CORNER
1	8'0"	NA	SKIMMER
2	8'0"	NA	PLAIN
1	7'0"	NA	PLAIN
1	6'0"	NA	RETURN
1	3'0"	NA	PLAIN
11	-	NA	A-FRAME
1	-	NA	N&B PKG
			S.A.: 559 sq.ft
			PER: 94'10"
1836CALC			DATE: 09-11-00

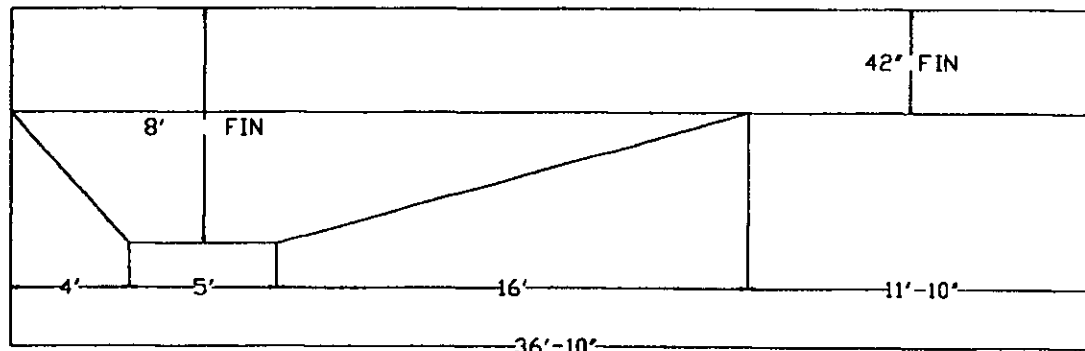

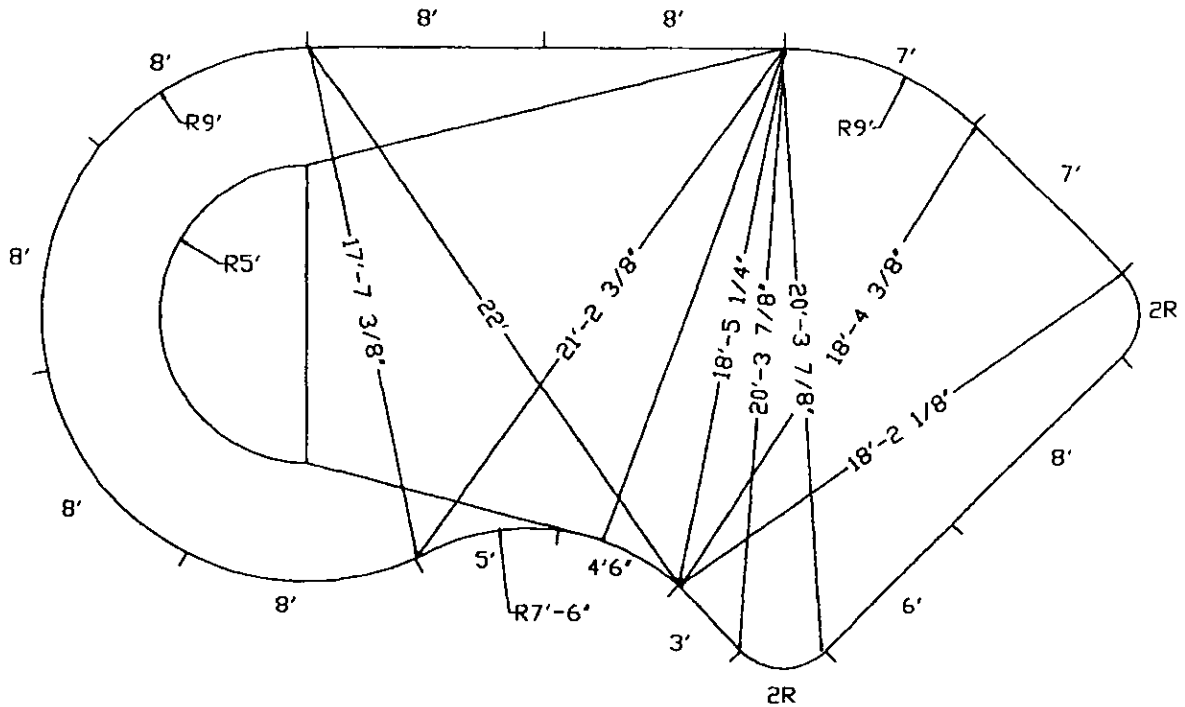
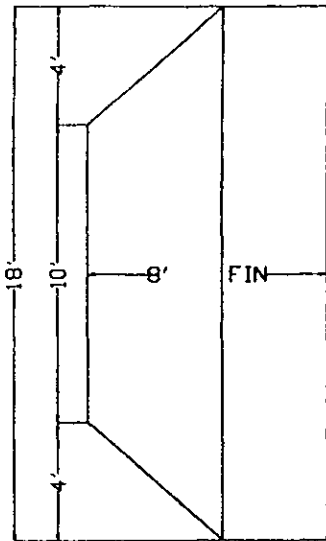

24 BAKER ST. P.O. BOX 100, HASTINGS ON KOL - 1Y0
 705-696-2385, 1-800-465-3433, FAX: 705-696-1922

18'X36'R.H. CALIFORNIAN

QTY.	LENGTH	RADIUS	TYPE
1	8'0"	9'0"	RETURN
3	8'0"	9'0"	PLAIN
1	7'0"	9'0"	PLAIN
1	5'0"	7'6"	REVERSE
1	4'6"	7'6"	REVERSE
2	3'2"	2'0"	CORNER
1	8'0"	NA	SKIMMER
2	8'0"	NA	PLAIN
1	7'0"	NA	PLAIN
1	6'0"	NA	RETURN
1	3'0"	NA	PLAIN
11	-	NA	A-FRAME
1	-	NA	N&B PKG
			S.A.: 559 sq.ft
			PER: 94'10"
1836CAL.C			DATE: 09-11-00

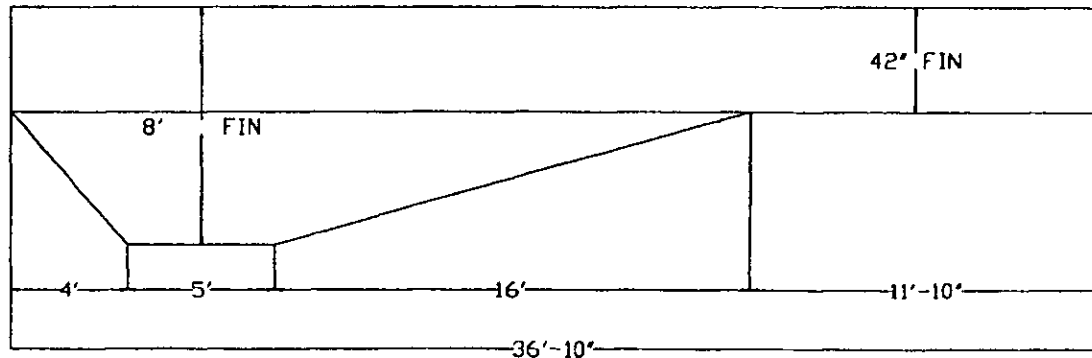

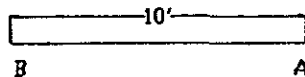
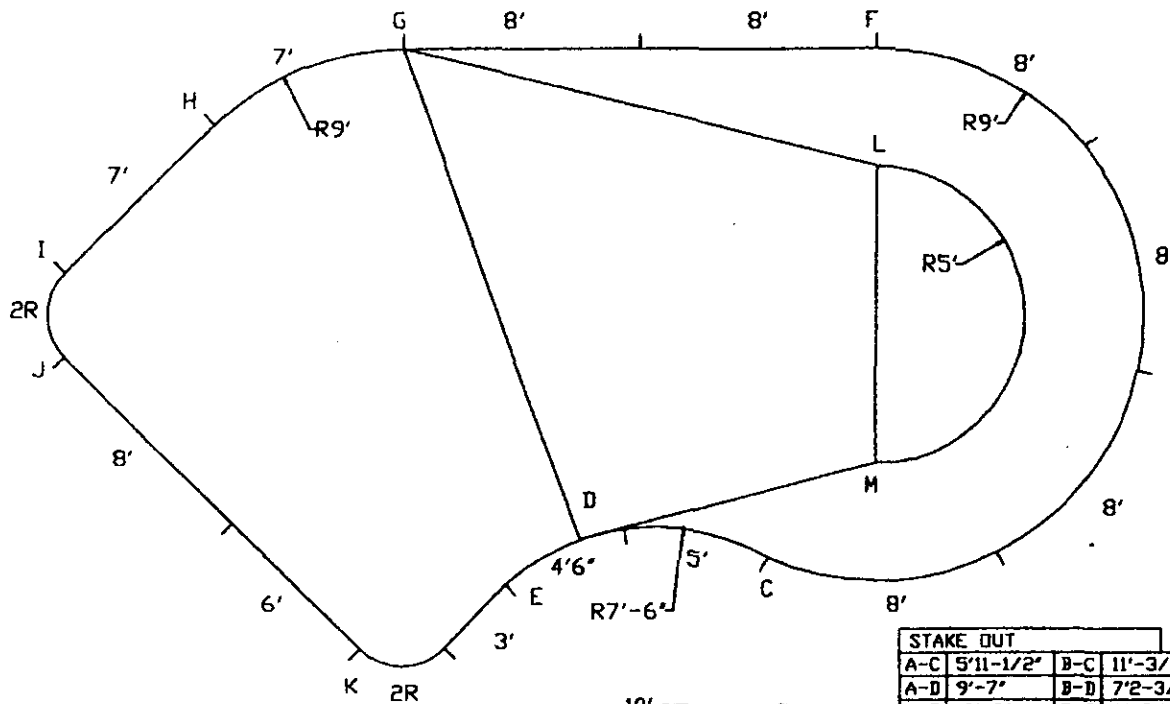

STAKE OUT			
A-C	5'11-1/2"	B-C	11'-3/4"
A-D	9'-7"	B-D	7'2-3/4"
A-E	10'-9"	B-E	5'-3/4"
A-F	23'4"	B-F	26'6-1/2"
A-G	26'6-1/2"	B-G	23'4"
A-H	28'2-1/2"	B-H	22'6-3/4"
A-I	28'10-1/4"	B-I	21'1-7/8"
A-J	27'5-1/4"	B-J	19'2"
A-K	14'8"	B-K	5'3"
A-L	19'4-1/2"	B-L	23'1-3/4"
A-M	9'7-1/2"	B-M	15'10-3/4"

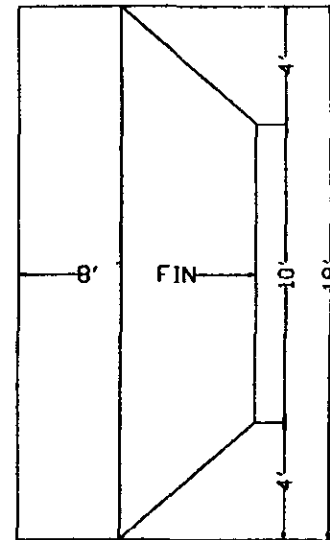

24 BAKER ST., P.O. BOX 100, HASTINGS ON KOL-1YO
705-696-2385, 1-800-465-3433, FAX: 705-696-1922

18' X 36' L.H. CALIFORNIAN

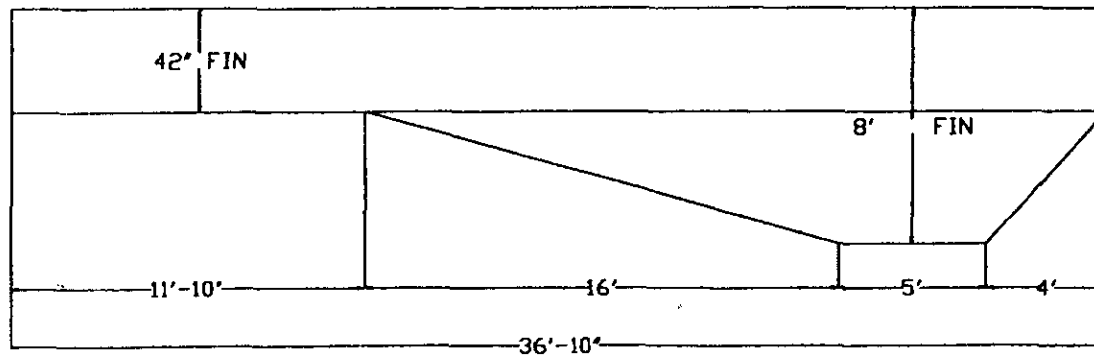

QTY.	LENGTH	RADIUS	TYPE
1	8'0"	9'0"	RETURN
3	8'0"	9'0"	PLAIN
1	7'0"	9'0"	PLAIN
1	5'0"	7'6"	REVERSE
1	4'6"	7'6"	REVERSE
2	3'2"	2'0"	CORNER
1	8'0"	NA	SKIMMER
2	8'0"	NA	PLAIN
1	7'0"	NA	PLAIN
1	6'0"	NA	RETURN
1	3'0"	NA	PLAIN
11	-	NA	A-FRAME
1	-	NA	N&B PKG
			S.A.: 559 sq.ft
			PER: 94'10"
1836CALC			DATE: 09-11-00

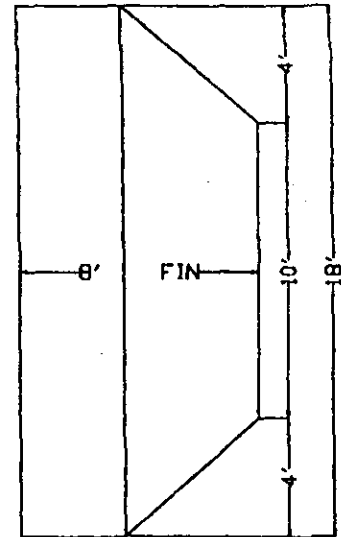
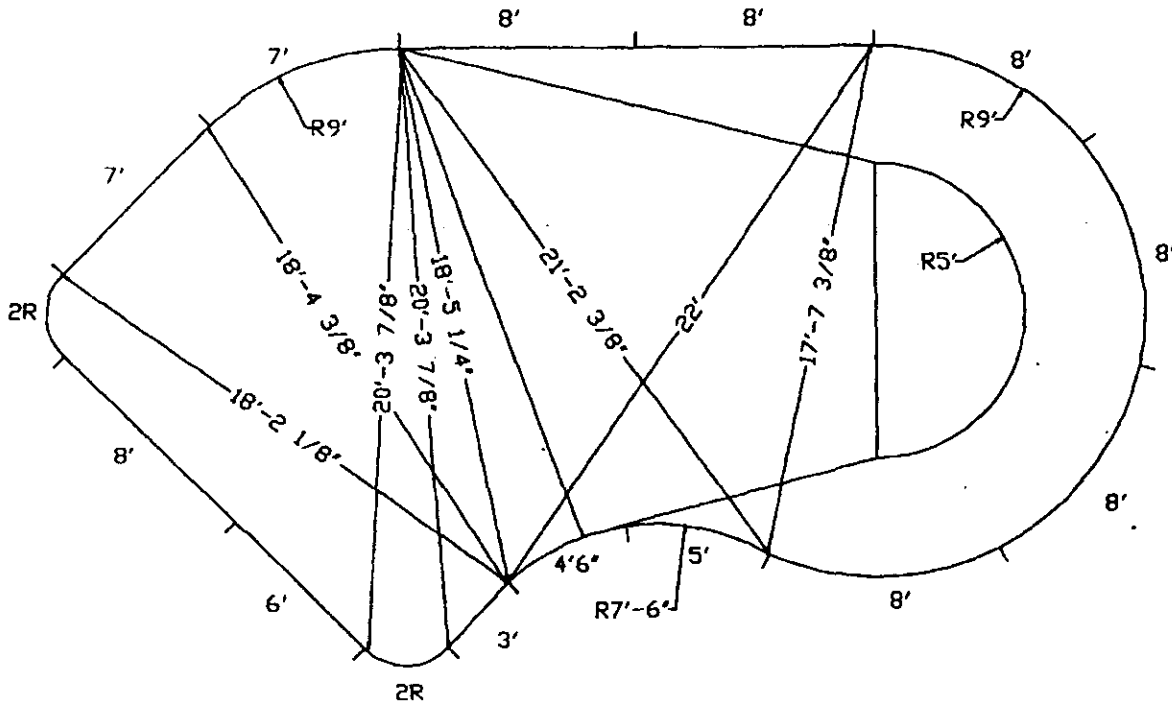

24 BAKER ST. P.O. BOX 100, HASTINGS ON COL. - NY 0
 705-696-2383 1-800-465-3433 FAX 705-696-1922

18' X 36' L.H. CALIFORNIAN

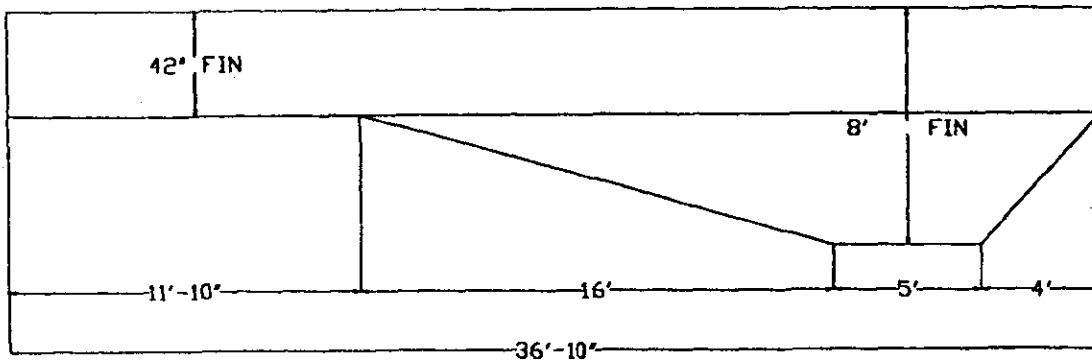

QTY.	LENGTH	RADIUS	TYPE
1	8'0"	9'0"	RETURN
3	8'0"	9'0"	PLAIN
1	7'0"	9'0"	PLAIN
1	5'0"	7'6"	REVERSE
1	4'6"	7'6"	REVERSE
2	3'2"	2'0"	CORNER
1	8'0"	NA	SKIMMER
2	8'0"	NA	PLAIN
1	7'0"	NA	PLAIN
1	6'0"	NA	RETURN
1	3'0"	NA	PLAIN
11	-	NA	A-FRAME
1	-	NA	N&B PKG
			S.A. 559 sq.ft
			PER: 94'10"
1836CALC			DATE: 09-11-00

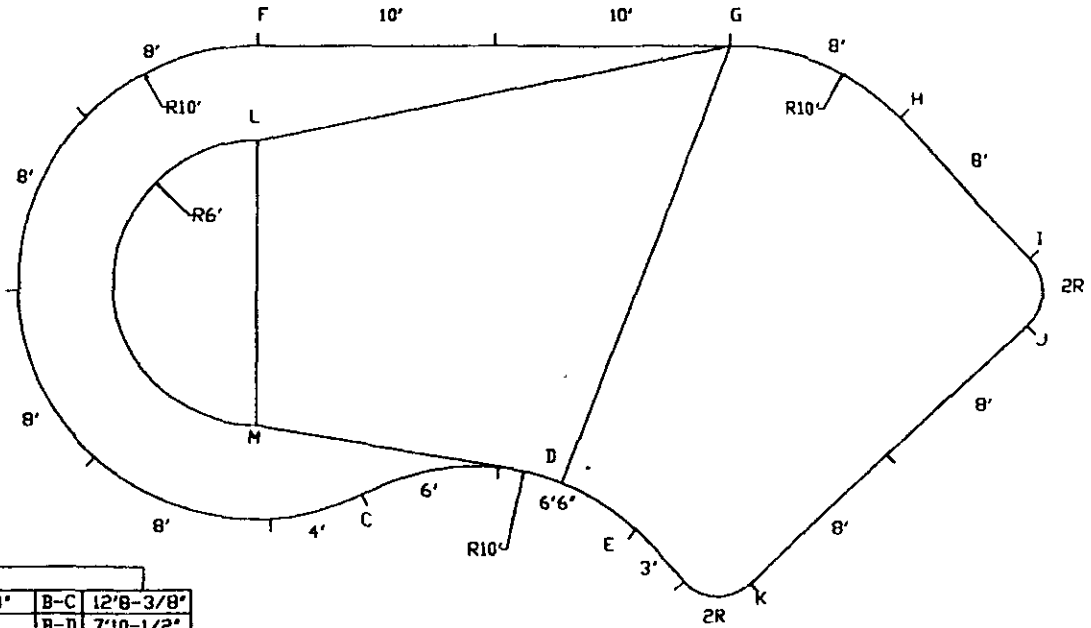
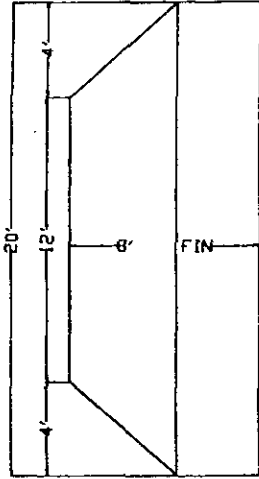

STAKE OUT			
A-C	7'-3/4"	B-C	12'8-3/8"
A-D	10'11"	B-D	7'10-1/2"
A-E	12'4-1/2"	B-E	5'8-1/4"
A-F	26'5-3/4"	B-F	30'-1/4"
A-G	30'-1/4"	B-G	26'5-3/4"
A-H	31'11"	B-H	26'
A-I	32'6-1/2"	B-I	24'7-1/4"
A-J	31'-3/4"	B-J	22'8"
A-K	16'3-3/8"	B-K	6.9-3/4"
A-L	22'6-3/4"	B-L	26'7-1/2"
A-M	11'2-1/4"	B-M	18'-1/4"

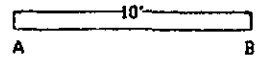

24 BAKER ST, P.O. BOX 100, HASTINGS ON KOL - 1Y0
 705-696-2385, 1-800-465-3433, FAX 705-696-1922

20'X44' R.H. CALIFORNIAN

QTY.	LENGTH	RADIUS	TYPE
1	8'0"	10'0"	RETURN
4	8'0"	10'0"	PLAIN
1	4'0"	10'0"	PLAIN
1	8'0"	10'0"	REVERSE
1	4'6"	10'0"	REVERSE
2	3'2"	2'0"	CORNER
1	10'0"	NA	PLAIN
1	10'0"	NA	SKIMMER
1	8'0"	NA	RETURN
2	8'0"	NA	PLAIN
1	3'0"	NA	PLAIN
12	-	NA	A-FRAME
1	-	NA	N&B PKG
			S.A.: 730 sq.Ft.
			PER: 109'10"
2044CALC			DATE: 09-11-00

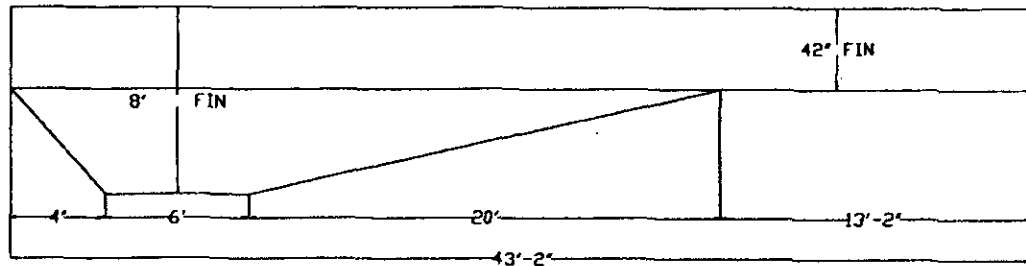

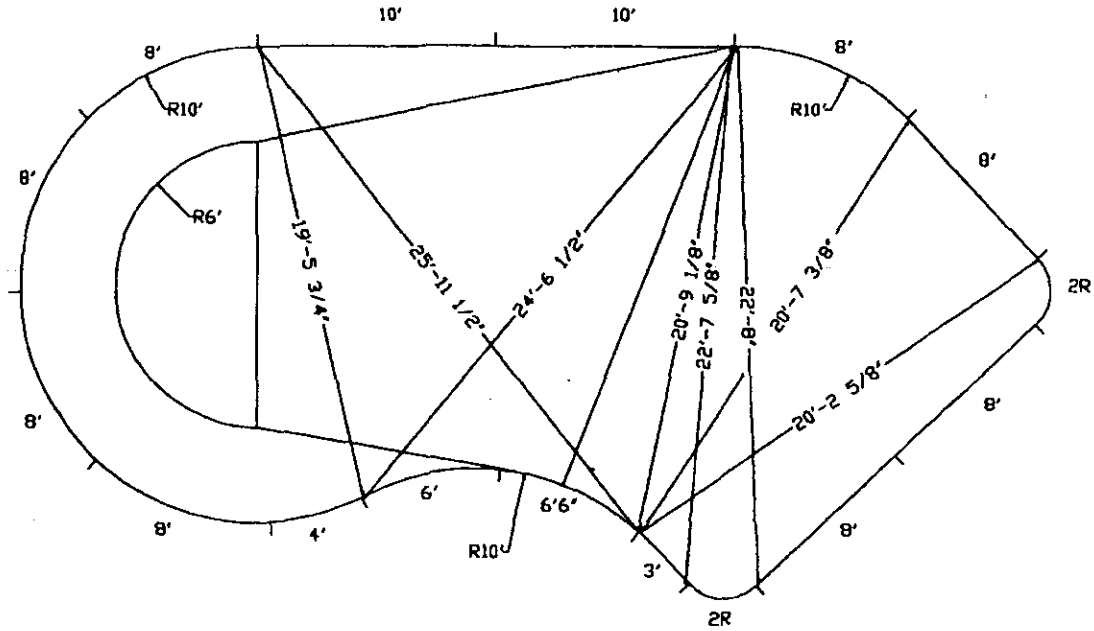
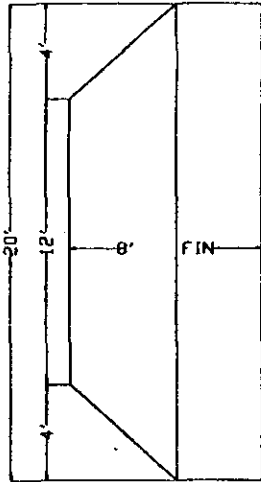

24 BAKER ST., P.O. BOX 100, HASTINGS ON KOL - 1Y0
 705-696-2385, 1-800-465-3433, FAX: 705-696-1922

20'X44' R.H. CALIFORNIAN

QTY.	LENGTH	RADIUS	TYPE
1	8'0"	10'0"	RETURN
4	8'0"	10'0"	PLAIN
1	4'0"	10'0"	PLAIN
1	8'0"	10'0"	REVERSE
1	4'6"	10'0"	REVERSE
2	3'2"	2'0"	CORNER
1	10'0"	NA	PLAIN
1	10'0"	NA	SKIMMER
1	8'0"	NA	RETURN
2	8'0"	NA	PLAIN
1	3'0"	NA	PLAIN
12	-	NA	A-FRAME
1	-	NA	N&B PKG
			S.A.: 730 sq.ft.
			PER: 109'10'
2044CALC			DATE: 09-11-00

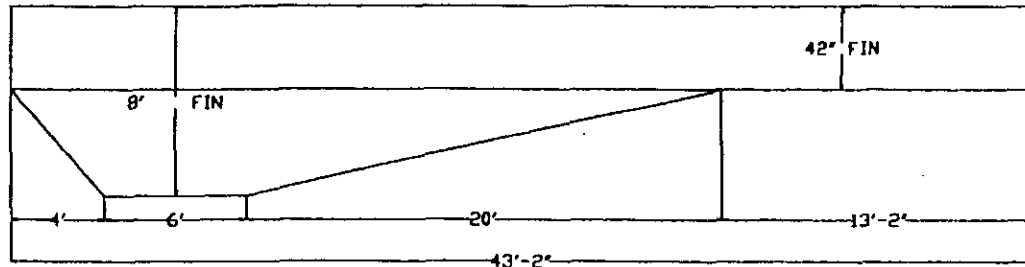

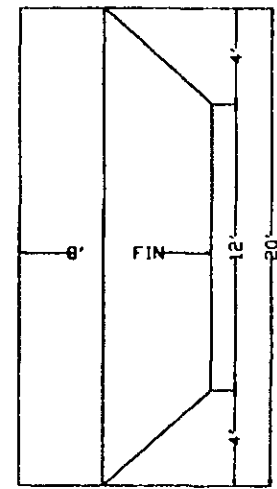
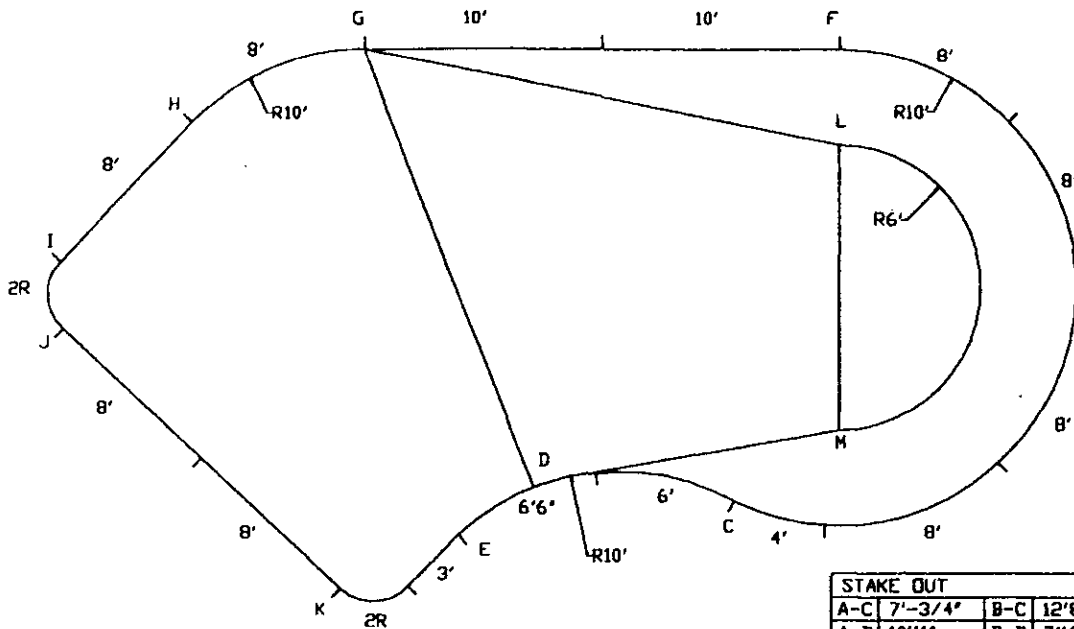

STAKE OUT			
A-C	7'-3/4"	B-C	12'-8-3/8"
A-D	10'11"	B-D	7'10-1/2"
A-E	12'-4-1/2"	B-E	5'-8-1/4"
A-F	26'-5-3/4"	B-F	30'-1/4"
A-G	30'-1/4"	B-G	26'-5-3/4"
A-H	31'11"	B-H	26'
A-I	32'-6-1/2"	B-I	24'-7-1/4"
A-J	31'-3/4"	B-J	22'-8"
A-K	16'-3-3/8"	B-K	6'-9-3/4"
A-L	22'-6-3/4"	B-L	26'-7-1/2"
A-M	11'-2-1/4"	B-M	18'-1/4"

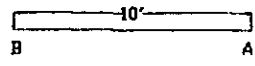

24 BAKER ST, P.O. BOX 100, HASTINGS DN, KOL-1Y0
 705-696-2383, 1-800-465-3433, FAX: 705-696-1922

20'X44' L.H. CALIFORNIAN

QTY.	LENGTH	RADIUS	TYPE
1	8'0"	10'0"	RETURN
4	8'0"	10'0"	PLAIN
1	4'0"	10'0"	PLAIN
1	8'0"	10'0"	REVERSE
1	4'6"	10'0"	REVERSE
2	3'2"	2'0"	CORNER
1	10'0"	NA	PLAIN
1	10'0"	NA	SKIMMER
1	8'0"	NA	RETURN
2	8'0"	NA	PLAIN
1	3'0"	NA	PLAIN
12	-	NA	A-FRAME
1	-	NA	N&B PKG
			S.A.: 730 sq.ft.
			PER: 109'10'
2044CALC			DATE: 09-11-00

