

ATOMIC
ARCHITECTURAL
SHEET METAL,
INC.

ASM Panel Brochure

3207 Labore Road
Vadnais Heights, MN 55110
Phone: 651-646-1706
Fax: 651-646-1684
atomic@atomicsheetmetal.com
www.atomicsheetmetal.com

ACM- ALUMINUM COMPOSITE PANELS

1. ASM D-J Panel (Dry-Joint)
2. ASM W-S Panel (Wet-Sealed)
3. ASM Column Cover

METAL ROOFING PANELS

4. ASM M-L Panel (Mechanical Lock)
5. ASM N-S Panel (Nail Strip)
6. ASM S-L Panel (Snap Lock)
7. ASM S-S Panel (Standing Seam)

METAL WALL & SOFFIT PANELS

8. ASM F-L-W Panel (Flat Lock Wall)
9. ASM F-S-F Panel (Flat Seam Flush)
10. ASM F-S Panel (Flush Seam)
11. ASM Reveal Panel

SPECIALTY PANELS

12. Phenolic Panel
13. Perforated Metal

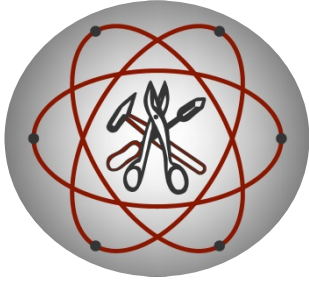

ATOMIC

Architectural Sheet Metal, Inc.

3207 Labore Road | Vadnais Heights, MN 55110

Phone: 651-646-1706 | Fax: 651-646-1684

email: atomic@atomicsheetmetal.com

www.atomicsheetmetal.com

ASM D-J PANEL

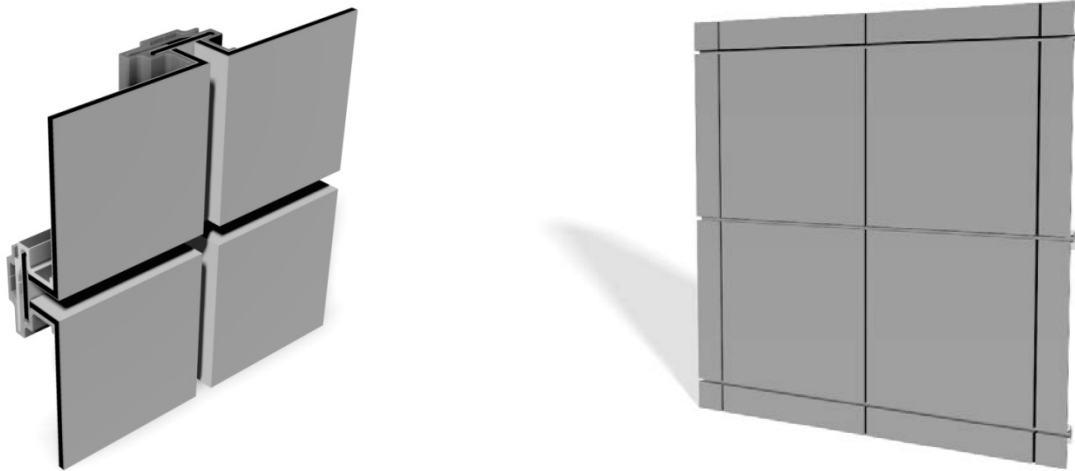

The ASM D-J (Dry-Joint) Composite Panel features:

- Dry-Joint rainscreen system
- 4mm aluminum composite material (Most Common)
- Available joint sizes from 1/16" to 1-1/2"
- 1-3/4" panel depth (2-1/2" total with hat channel) Hat channel required at certain conditions
- Fabricated on a CNC machine using the route and returned method
- Radiused and vented options
- Panel widths can vary and are available up to 5' max
- Panel lengths can vary and are available up to 16' max
- We work with the top composite material manufacturers for a wide range of color and finish options
- Tested in accordance with ASTM E 283-99, E 330-97e1, E 331-00 for air infiltration, water resistance, and structural performance

Please contact us for more information regarding pricing, installation, detailing, or for any questions you may have.
3/12/2018

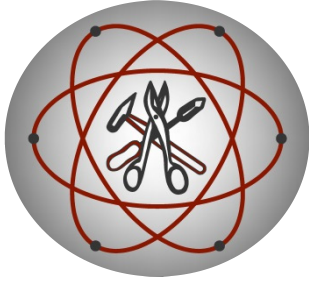

ATOMIC

Architectural Sheet Metal, Inc.

3207 Labore Road | Vadnais Heights, MN 55110

Phone: 651-646-1706 | Fax: 651-646-1684

email: atomic@atomicsheetmetal.com

www.atomicsheetmetal.com

ASM W-S PANEL

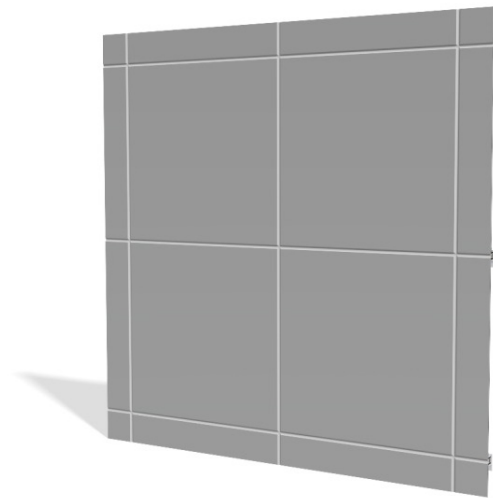
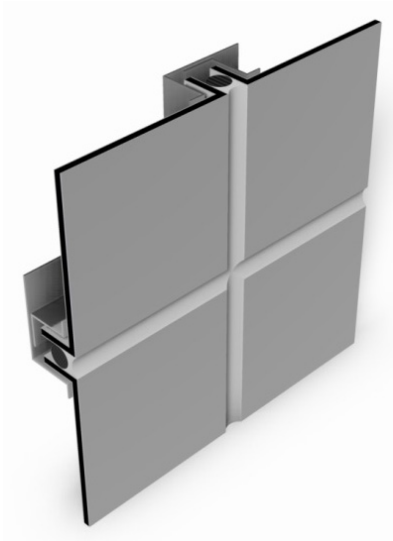

The ASM W-S (Wet-Seal) Composite Panel features:

- Weather-sealed panel joints utilizing high quality silicone sealant with backer rod
- 4mm aluminum composite material (Most common)
- 1/2" panel joints typical
- 1-1/2" panel depth (2-1/4" total with hat channel) Hat channel required at certain conditions
- Fabricated on a CNC machine using the route and returned method
- Radiused and vented options
- Panel widths can vary and are available up to 5' max
- Panel lengths can vary and are available up to 16' max
- We work with the top composite material manufacturers for a wide range of color and finish options

Please contact us for more information regarding pricing, installation, detailing, or for any questions you may have.
5/5/2016

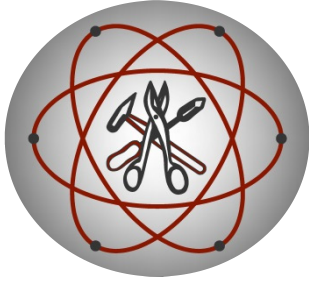

ATOMIC

Architectural Sheet Metal, Inc.

3207 Labore Road | Vadnais Heights, MN 55110

Phone: 651-646-1706 | Fax: 651-646-1684

email: atomic@atomicsheetmetal.com

www.atomicsheetmetal.com

ASM Column Cover

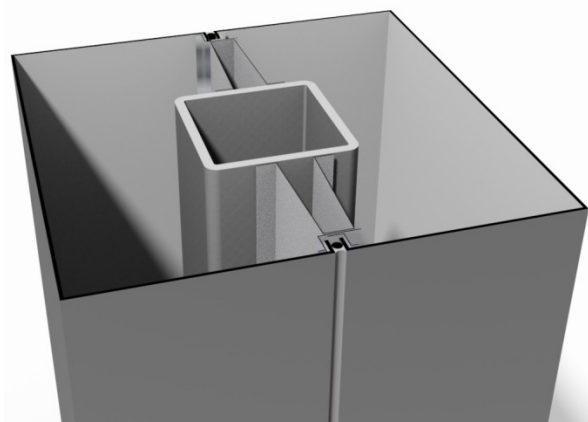
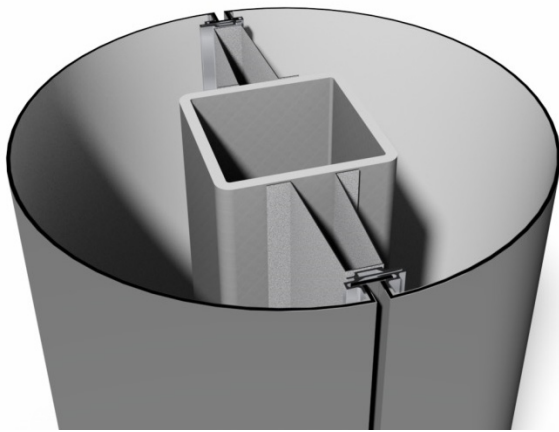

The ASM Column Cover features:

- 4mm aluminum composite material (Most common)
- Various profiles (Round, Square, Rectangle, Full Column or Half)
- Fabricated on a CNC machine using the route and returned method
- Dry-Joint, Wet Sealed, or Hairline Joint options
- 10" minimum Diameter for Round
- Available in various Finishes (Colors, Woodgrains, Stone, Aluminum, & Stainless Steel)
- We work with the top composite material manufacturers for a wide range of color and finish options

Please contact us for more information regarding pricing, installation, detailing, or for any questions you may have.
5/5/2016

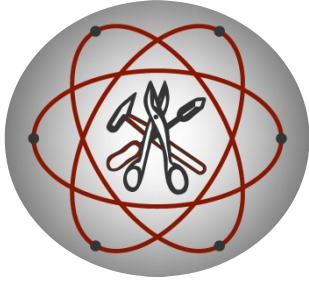

ATOMIC

Architectural Sheet Metal, Inc.

3207 Labore Road | Vadnais Heights, MN 55110

Phone: 651-646-1706 | Fax: 651-646-1684

email: atomic@atomicsheetmetal.com

www.atomicsheetmetal.com

ASM M-L PANEL

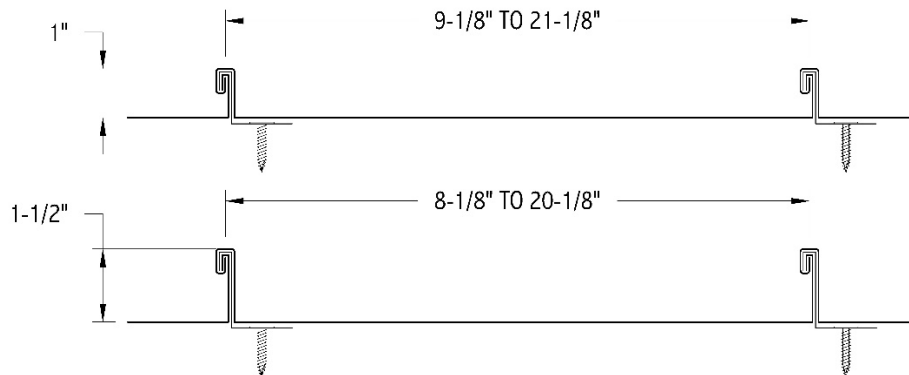

The ASM M-L (Mechanical Lock) Panel features:

- 1" or 1-1/2" tall ribs
- Various widths to choose from (contact us for best o.c.)
- Smooth or with stiffening ribs
- Can be curved for radiused roofs
- Available in various materials (Steel, Aluminum, Copper, Zinc)
- Available in various gauges (Steel-24 & 22ga. Alum.-.032)
- We work with the top sheet metal manufacturers for a wide range of material, color, and finish options

Please contact us for more information regarding pricing, installation, detailing, or for any questions you may have.
5/5/2016

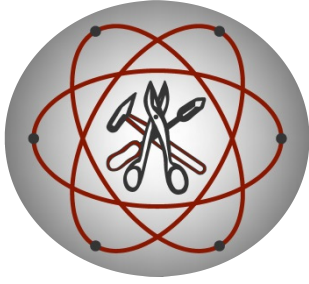

ATOMIC

Architectural Sheet Metal, Inc.

3207 Labore Road | Vadnais Heights, MN 55110

Phone: 651-646-1706 | Fax: 651-646-1684

email: atomic@atomicsheetmetal.com

www.atomicsheetmetal.com

ASM N-S PANEL

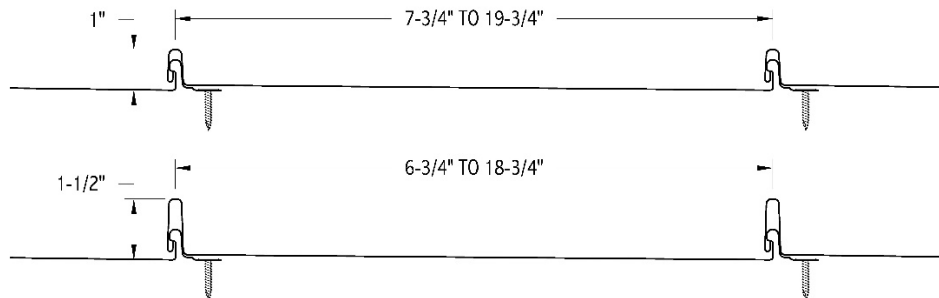

The ASM N-S (Nail-Strip) Panel features:

- 1" or 1-1/2" tall ribs
- Various widths to choose from (contact us for best o.c.)
- Smooth or with stiffening ribs
- Available in various materials (Steel, Aluminum, Copper, Zinc)
- Available in various gauges (Steel-24 & 22ga. Alum.-.032)
- We work with the top sheet metal manufacturers for a wide range of material, color, and finish options

Please contact us for more information regarding pricing, installation, detailing, or for any questions you may have.
5/5/2016

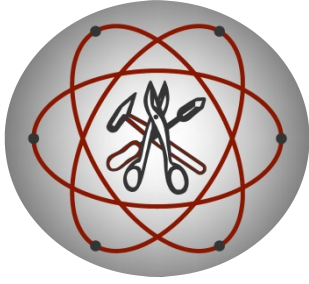

ATOMIC

Architectural Sheet Metal, Inc.

3207 Labore Road | Vadnais Heights, MN 55110

Phone: 651-646-1706 | Fax: 651-646-1684

email: atomic@atomicsheetmetal.com

www.atomicsheetmetal.com

ASM S-L PANEL

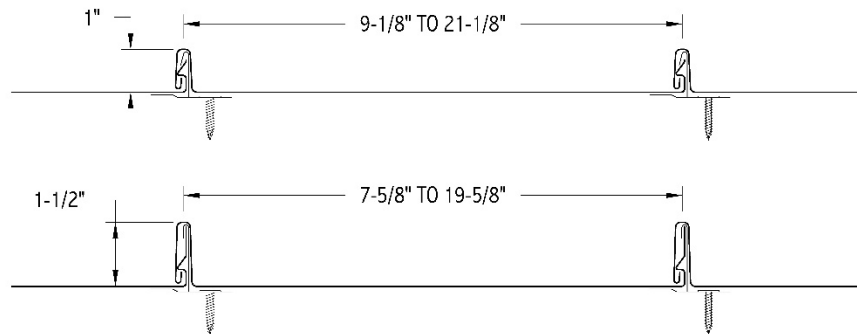

The ASM S-L (Snap-Lock) Panel features:

- 1" or 1-1/2" tall ribs
- Various widths to choose from (contact us for best o.c.)
- Smooth or with stiffening ribs
- Available in various materials (Steel, Aluminum, Copper, Zinc)
- Available in various gauges (Steel-24 & 22ga. Alum.-.032)
- We work with the top sheet metal manufacturers for a wide range of material, color, and finish options

Please contact us for more information regarding pricing, installation, detailing, or for any questions you may have.
5/5/2016

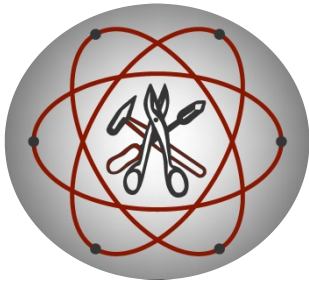

ATOMIC

Architectural Sheet Metal, Inc.

3207 Labore Road | Vadnais Heights, MN 55110

Phone: 651-646-1706 | Fax: 651-646-1684

email: atomic@atomicsheetmetal.com

www.atomicsheetmetal.com

ASM S-S PANEL

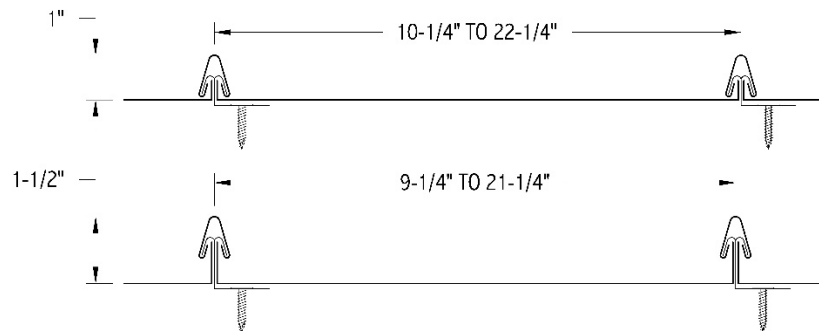

The ASM S-S (Standing Seam) Panel features:

- 1" or 1-1/2" tall ribs
- Various widths to choose from (contact us for best o.c.)
- Smooth or with stiffening ribs
- Can be curved for radiused roofs
- Available in various materials (Steel, Aluminum, Copper, Zinc)
- Available in various gauges (Steel-24 & 22ga. Alum.-.032)
- We work with the top sheet metal manufacturers for a wide range of material, color, and finish options

Please contact us for more information regarding pricing, installation, detailing, or for any questions you may have.
5/5/2016

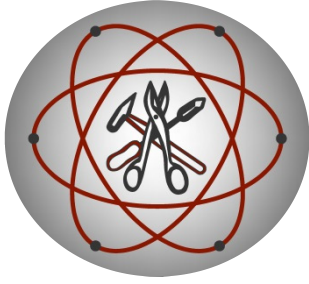

ATOMIC

Architectural Sheet Metal, Inc.

3207 Labore Road | Vadnais Heights, MN 55110

Phone: 651-646-1706 | Fax: 651-646-1684

email: atomic@atomicsheetmetal.com

www.atomicsheetmetal.com

ASM F-L-W PANEL

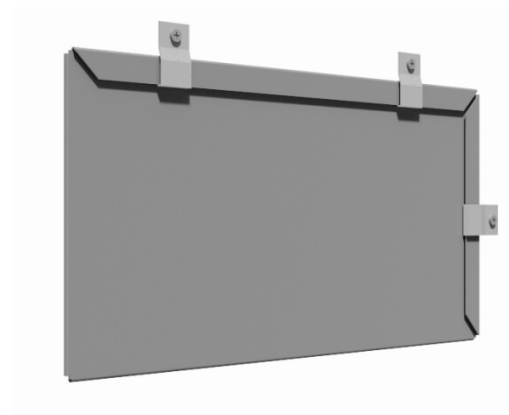
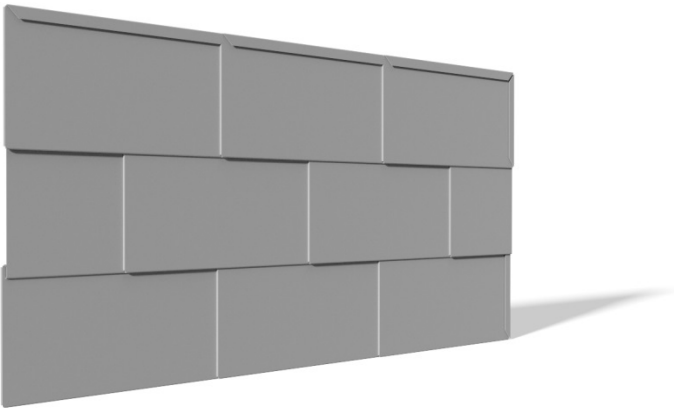

The ASM F-L-W (Flat Lock Wall) Panel features:

- Available in various heights & widths to create a square, rectangle, or diamond pattern (contact us for best o.c.)
- Interlocking system with concealed fasteners
- Available in various materials (Steel, Aluminum, Copper, Zinc)
- Available in various gauges (Steel-24 & 22ga. Alum.-.032)
- We work with the top sheet metal manufacturers for a wide range of material, color, and finish options

Please contact us for more information regarding pricing, installation, detailing, or for any questions you may have.
5/5/2016

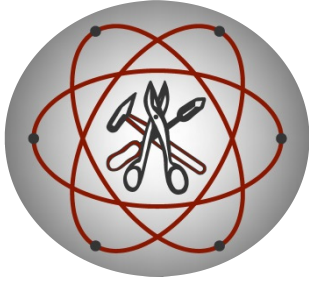

ATOMIC

Architectural Sheet Metal, Inc.

3207 Labore Road | Vadnais Heights, MN 55110

Phone: 651-646-1706 | Fax: 651-646-1684

email: atomic@atomicsheetmetal.com

www.atomicsheetmetal.com

ASM F-S-F PANEL

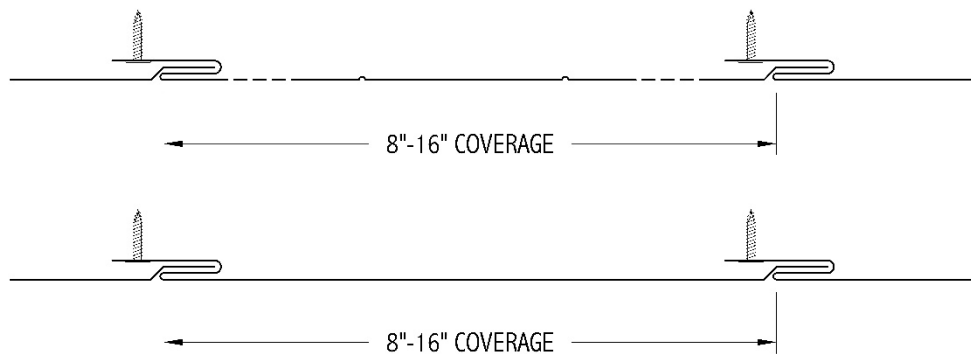

The ASM F-S-F (Flat-Seam Flush) Panel features:

- Wall and soffit application
- A slim 3/8" deep
- 8"-16" coverage and a 12' max length (contact us for best o.c.)
- Smooth, vented, with stiffening ribs, or a combination
- Concealed fasteners
- Available in various materials (Steel, Aluminum, Copper, Zinc)
- Available in various gauges (Steel-24 & 22ga. Alum.-.032)
- We work with the top sheet metal manufacturers for a wide range of material, color, and finish options

Please contact us for more information regarding pricing, installation, detailing, or for any questions you may have.
5/5/2016

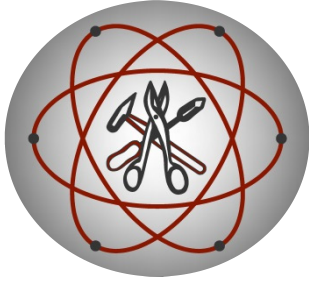

ATOMIC

Architectural Sheet Metal, Inc.

3207 Labore Road | Vadnais Heights, MN 55110

Phone: 651-646-1706 | Fax: 651-646-1684

email: atomic@atomicsheetmetal.com

www.atomicsheetmetal.com

ASM F-S PANEL



Popular Profiles

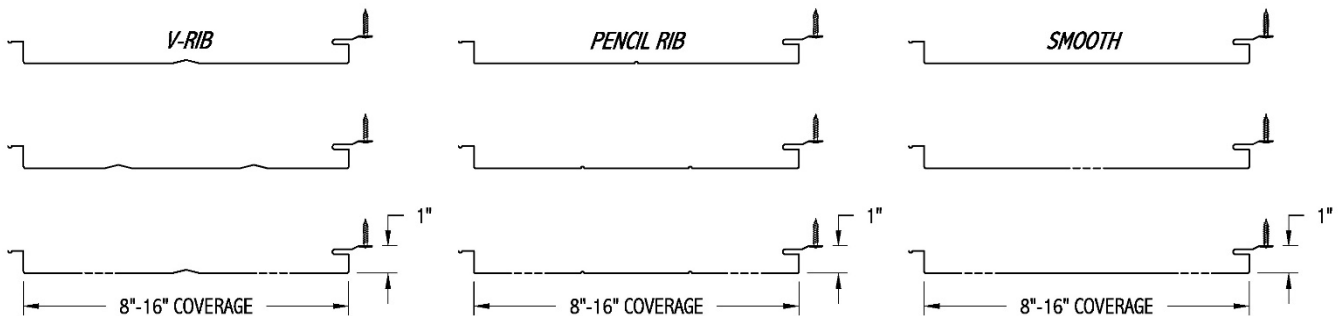

The ASM F-S (Flush-Seam) Panel features:

- Wall and soffit application
- Can be used over open framing or solid substrate (certain conditions may require additional furring)
- 8"-16" coverage (contact us for best o.c.)
- Smooth, vented, with stiffening ribs, or a combination (Venting offered in 24 ga. steel only)
- Concealed fasteners
- Available in various materials (Steel, Aluminum, Copper, Zinc)
- Available in various gauges (Steel-24 & 22 ga. Alum.-.032)
- We work with the top sheet metal manufacturers for a wide range of material, color, and finish options

Please contact us for more information regarding pricing, installation, detailing, or for any questions you may have.

6/6/2016

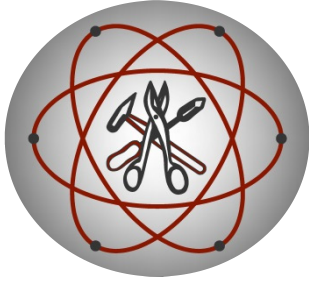

ATOMIC

Architectural Sheet Metal, Inc.

3207 Labore Road | Vadnais Heights, MN 55110

Phone: 651-646-1706 | Fax: 651-646-1684

email: atomic@atomicsheetmetal.com

www.atomicsheetmetal.com

ASM REVEAL PANEL

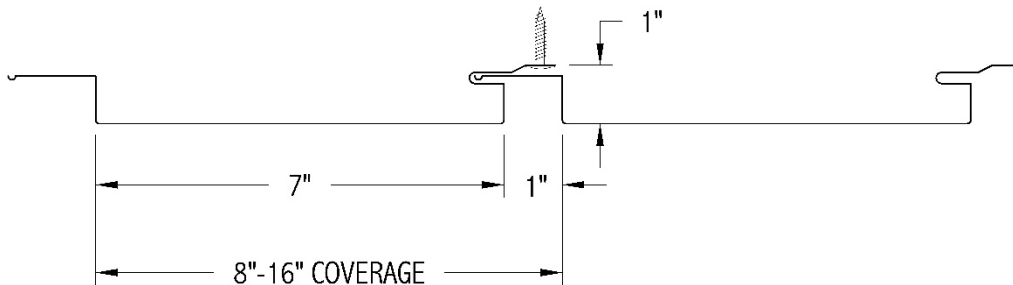

The ASM Reveal Panel features:

- Wall and soffit application
- Can be used over open framing or solid substrate (certain conditions may require additional furring)
- 1" reveal
- 8"-16" coverage (contact us for best o.c.)
- Smooth, vented, with stiffening ribs, or a combination
- Concealed fasteners
- Available in various materials (Steel, Aluminum, Copper, Zinc)
- Available in various gauges (Steel-24 & 22ga. Alum.-.032)
- We work with the top sheet metal manufacturers for a wide range of material, color, and finish options

Please contact us for more information regarding pricing, installation, detailing, or for any questions you may have.
5/5/2016

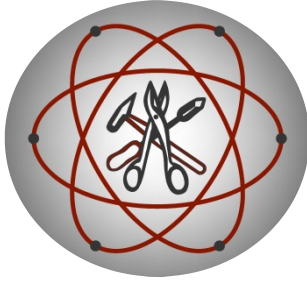

ATOMIC

Architectural Sheet Metal, Inc.

3207 Labore Road | Vadnais Heights, MN 55110

Phone: 651-646-1706 | Fax: 651-646-1684

email: atomic@atomicsheetmetal.com

www.atomicsheetmetal.com

PHENOLIC PANEL

EXPOSED FASTENER SYSTEM

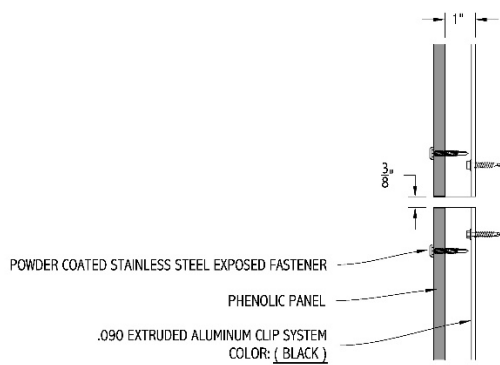

CONCEALED FASTENER SYSTEM

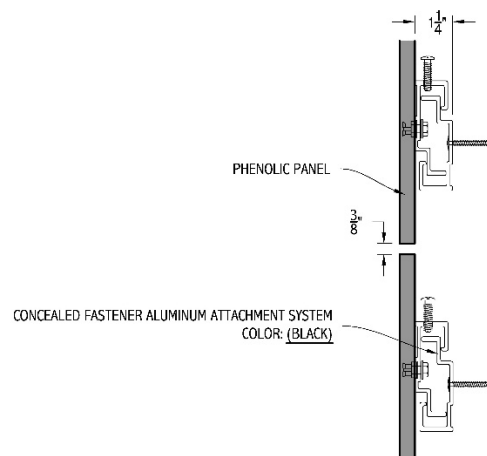

The Phenolic Panel features:

- Rainscreen cladding system for wall and soffit applications
- 3/8" reveal joints typical
- Exposed or Concealed fastener systems
- Available in various thicknesses from 6-22mm (Contact us for standard vs. special thicknesses)
- We work with the top Phenolic manufacturers for a wide range of material, color, and finish options

Please contact us for more information regarding pricing, installation, detailing, or for any questions you may have.
5/5/2016



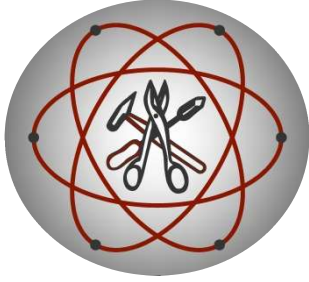

ATOMIC

Architectural Sheet Metal, Inc.

3207 Labore Road | Vadnais Heights, MN 55110

Phone: 651-646-1706 | Fax: 651-646-1684

email: atomic@atomicsheetmetal.com

www.atomicsheetmetal.com

PERFORATED METAL



ASM Perforated Metal:

Our perforation capabilities provide a wide variety of options in various materials and finishes for projects large or small. From simple hole pattern designs for venting or screening purposes to custom designs with various hole sizes and shapes.

- Round hole patterns
- Square hole patterns
- Staggered & Straight Patterns
- Various hole sizes and on-centers

Please contact us for more information regarding pricing, installation, detailing, or for any questions you may have.
10/23/2018

ATOMIC
ARCHITECTURAL
SHEET METAL,
INC.

Fabricating & Installing
for over 25 years

