

# VINCENT

THE MORDERN  
OFFICE  
SOLUTION



# VINCENT

An expression of shapes and materials... fill the office with dynamism, cool and silent high gloss surface and pristine natural veneer that brings out the new contemporary approach.

The multi-angled legs are the main design features of VINCENT executive series, available in various color and finishing options. Natural color, white, Wood grains, Greys, Black, and Metal are part of the elements of design theme for VINCENT collection.

Indulge in the cross-era design...the Vincent executive series.

THE MODERN  
**OFFICE  
SOLUTION**







Natural wood grain blends with high gloss finishing, friendly and warmth, a classic combination that never go out of style.

VINCENT





# VINCENT



# VINCENT

VINCENT executive collection provides modular units for flexible space planning, available in table shapes, cabinets, storage to meeting tables.







VNICENT offers creative optional based, featuring side table panel that provides stability and enhances the authority expression to the simple-lined table shape.

VINCENT





Natural features at its most unspoiled appearance, combining white sofa that enhances its purity and substance.

VINCENT





Bold and creative, the multi-shape block base empowers the executive table which will naturally become the highlight of the conference room

VINCENT





Meeting table for the leaders, a dynamic looking, sleek, creative conference table for today's contemporary offices.

VINCENT





Balance, symmetrical an everlasting stylish meeting table creates powerful voices, unique impression and memorable events.

VINCENT





VINCENT





VINCENT





VINCENT





VINCENT





VINCENT









VINCENT





VINCENT





# VINCENT

The power, data, and voice cables are well organized to meeting users' needs. Under table wire racking provides easy accessibility, connecting wire from floor to table surface, CPU and computer.





# VINCENT

The color and material selections provide combinations that form a unique workplace.  
(Please refer to the actual product for final approval)



## Color Combination

### Die-cast Leg & Aluminum

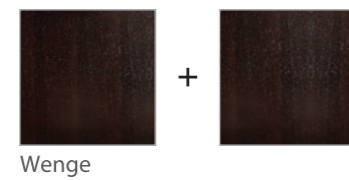
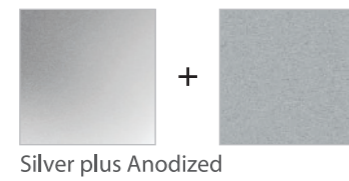

## Tabletop Board

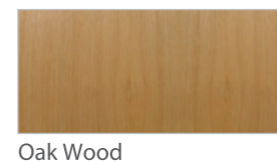

## Main Table and Return

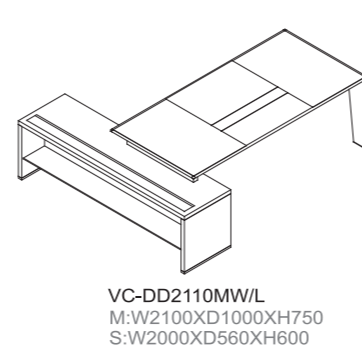
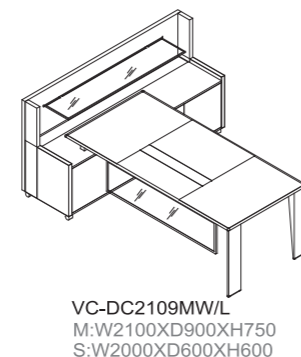
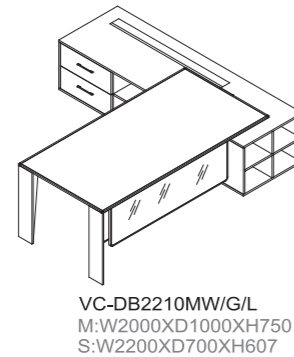
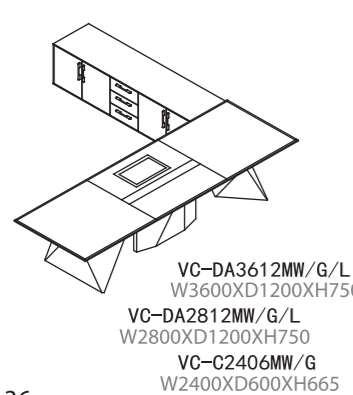

## Main Table and Return

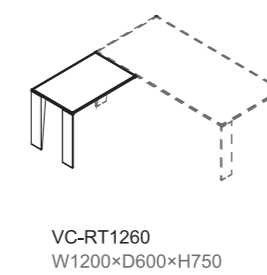
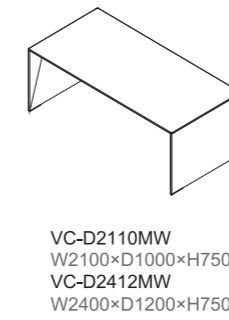
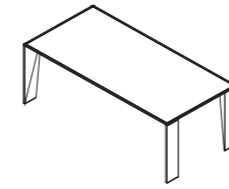

## Mobile Cabinet



## Meeting Table / Conference Table

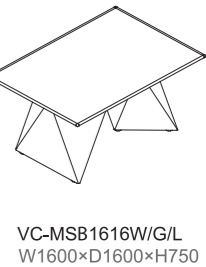
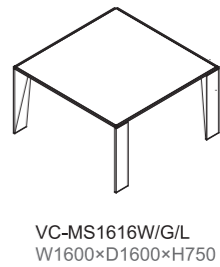
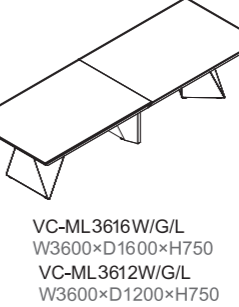
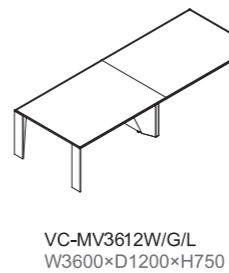
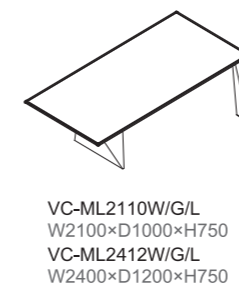

## Fixed Cabinet

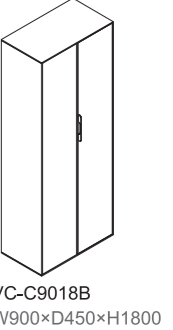
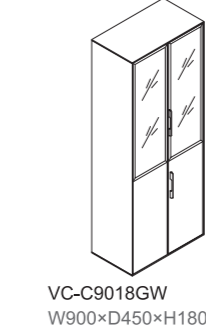
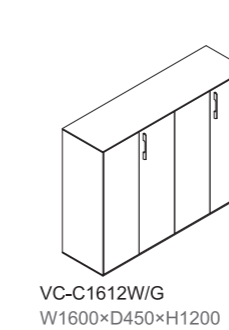
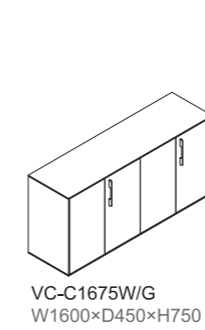

## Sliding Door Cabinet

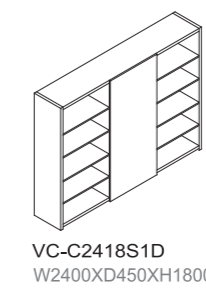
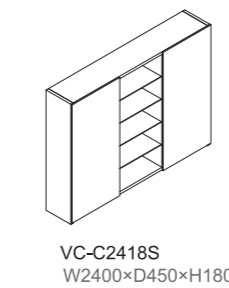
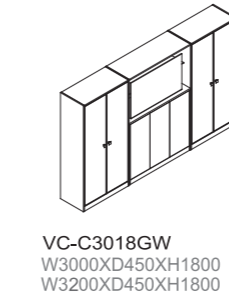

## Coffee Table

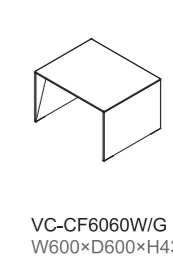
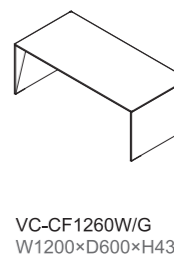

## Wall Shelf

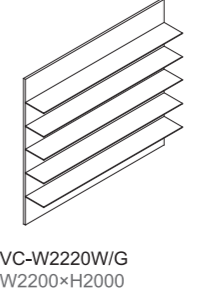
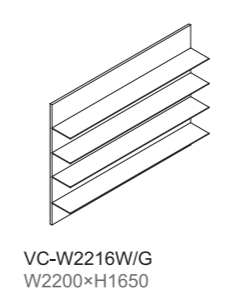
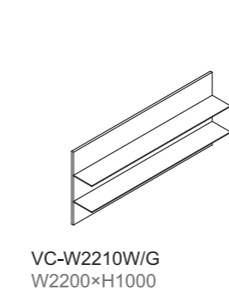

## Modesty Panel

