

# MARTIN'S ARCHERY COMPANY

ROUTE 5, BOX 127

WALLA WALLA, WASH. 99362

$$\begin{array}{r} 392 \\ 21785 \\ \hline 6 \\ 18 \end{array}$$

$$\begin{array}{r} 18 \\ 61785 \\ \hline 6 \\ 18 \end{array}$$

AREA CODE 509 Phone 529-2554



**INDEX**

<b>ADHESIVES</b> . . . . . 22, 25	<b>BUTTONS</b> . . . . . 15	<b>POINTS</b> . . . . . 4, 5, 25
<b>ARM GUARD</b> . . . . . 8, 9, 10	<b>CALLS</b> Wild . . . . . 19	" Bludgeon . . . . . 4, 5
<b>ARROWS</b> . . . . . 1	<b>CAMOUFLAGE</b> . . . . . 19	" Fish . . . . . 5
<b>ARROW</b> Box and Pads . . . 18	<b>CASE, Bow</b> . . . . . 23	<b>POUCH</b> . . . . . 8
" Case . . . . . 6	" Arrow . . . . . 6	" Powder . . . . . 10
" Cinch . . . . . 16	<b>CEMENT</b> . . . . . 22, 25	<b>POWDER, Glove</b> . . . . . 10
" Clips . . . . . 18	<b>CHARTS, Shaft Selection</b> . 24	<b>PRISMS, Sight</b> . . . . . 14
" Numbers . . . . . 18	<b>CHEST GUARD</b> . . . . . 9, 10	<b>PROTECTORS</b> . 9, 10, 11, 18
" Paint Dip Tube . . . 22	<b>CLIPS</b> . . . . . 18	<b>QUIVERS</b> . . . . . 6, 7, 11
" Rack . . . . . 18	<b>CLICKER</b> . . . . . 15, 16	" Bow . . . . . 11
" Reconditioning . . . 22	<b>CLOTHING, Camouflage</b> . 19	" Ground . . . . . 11
" Rests . . . . . 16, 17	<b>COMPASS</b> . . . . . 13	<b>RACKS</b> . . . . . 18
" Selection Charts . 24	<b>DIP TUBE, Paint</b> . . . . . 22	<b>REELS, Fish</b> . . . . . 5
" Shafts . . . . . 25	<b>EASEL</b> . . . . . 25	<b>RESTS, Arrow</b> . . . . . 16, 17
" Straightener . . . . 18	<b>EASTON SHAFT CHART</b> 24	<b>SCORE CARDS</b> . . . . . 22
" Tapering Tool . . . 23	<b>EXTENSION, Bow Sight</b> . 13	<b>SERVER, Bowstring</b> . . . . 20
<b>BACKSTOP NET</b> . . . . . 24	<b>FEATHERS</b> . . . . . 22	<b>SERVING THREAD</b> . . . . . 20
<b>BELTS</b> . . . . . 6	" Plastifletch . . . 22	<b>SHAFTS, Arrow</b> . . . . . 25
<b>BOWBIRD</b> . . . . . 1	<b>FEATHER TRIMMER</b> . . . 21	<b>SHAFT PAINTING</b> . . . . . 25
<b>BOWS</b> . . . . . 2, 3, 23	<b>FILE, Broadhead</b> . . . . . 5	<b>SHARPENER</b> . . . . . 5
<b>BOW</b> Camouflage . . . . . 19	<b>FISH ARROWS</b> . . . . . 1	<b>SIGHTS, Bow</b> . . . 12, 13, 14
" Case . . . . . 23	" Points . . . . . 5	" String . . . . . 14
" Clicker . . . . . 16	" Shafts . . . . . 25	<b>SIGHT RINGS</b> . . . . . 13, 14
" Compass . . . . . 13	<b>FLETCHING, Cement</b> . . . 25	<b>SIGHT WIRE</b> . . . . . 14
" Hand Locator . . . . 16	" " Fur . . . . . 22	<b>SLING, Bow</b> . . . . . 10
" Level . . . . . 16	" " Jig . . . . . 21	" Hunting . . . . . 14
" Quiver . . . . . 11	" " Vanes . . . . . 25	<b>SQUARE, Bow</b> . . . . . 15
" Rack . . . . . 18	<b>FUR FLETCH</b> . . . . . 22	<b>STABILIZER, Bow</b> . . . . . 16
" Reels . . . . . 5	<b>GLOVES</b> . . . . . 8	" " Flex-Con. . . . 16
" Saddle . . . . . 10	<b>GLOVE POWDER</b> . . . . . 10	<b>STRING, Bow</b> . . . . . 20
" Sights . . . . . 12, 13	<b>GLUE</b> . . . . . 22, 25	" Gauge . . . . . 15
" Sight Aperatures 12,13,14	<b>GUARDS</b> . . . . . 8, 9, 10	" Jig . . . . . 21
" Sight Extension . . . 13	<b>HORN MOUNTING KIT</b> . . 18	" Keeper . . . . . 20
" Sling . . . . . 10	<b>KLICHER</b> . . . . . 15, 16	" Sights . . . . . 14
" Square . . . . . 15	<b>KNIVES</b> . . . . . 23	" Silencer . . . . . 15
" Stabilizer . . . . . 16	<b>LACQUER</b> . . . . . 22	" Wax . . . . . 20
" Strings . . . . . 20	<b>LEVEL, Bow</b> . . . . . 16	<b>SUITS, Camouflage</b> . . . . . 19
" Stringer . . . . . 15	<b>LOCATOR, Hand</b> . . . . . 16	<b>TABS</b> . . . . . 10
" String Jig . . . . . 21	<b>LURE</b> . . . . . 19	<b>TAPE, Camouflage</b> . . . . . 19
" String Keeper . . . . . 20	<b>MATTS, Target. Back Cover</b>	<b>TAPERING TOOL</b> . . . . . 23
" Tip Protector . . . . . 18	<b>MICRO-FLITE Shaft Ch.</b> . 24	<b>TARGETS</b> . . 24, Back Cover
<b>BROADHEADS</b> . . . . . 4, 5, 25	<b>MOUNTING KIT, Horn</b> . . 18	" Easel . . . . . 25
<b>BROADHEAD</b> File . . . . . 5	<b>NET, Backstop</b> . . . . . 24	<b>TARGET MATTS</b> Back Cover
" " Sharpener . . . . . 5	<b>NOCKS</b> . . . . . 25	<b>THREAD, Serving</b> . . . . . 20
" " Shield . . . . . 11	<b>NOCKING POINTS</b> . . . . 15	<b>TRIMMER, Feather</b> . . . . . 21
<b>BRUSH BUTTONS</b> . . . . . 15	<b>NUMBERS, Arrow</b> . . . . . 18	<b>VANES</b> . . . . . 25
<b>BUCK LURE</b> . . . . . 19		<b>WAX</b> . . . . . 20

**TERMS:**

All prices F.O.B. Walla Walla. Cash with order or C.O.D., unless credit has been established.

**SHIPPING:**

Specify method of shipping or we will ship by least expensive means . . .

AIR MAIL - PARCEL POST - UNITED PARCEL SERVICE - AUTO FREIGHT (available in western states only)

**MOST ORDERS ARE SHIPPED THE SAME DAY RECEIVED BY US!**

- Prices subject to change without notice -

**MARTIN CUSTOM ARROWS**

- #050 Arrows - 5/16 shaft, 2 1/2" fletch. Packed in half or one gross box. Standard pack, 2/24" - 4/26" - 6/28" Extra 10% discount on 5 gross & up. ----- each .30
- #275 Arrows - 5/16 shaft, full clear lacquer finish with two color crest, for 30 to 40 lb. bows, 3" dyed white fletch; 24, 26, 28" lengths with target points. Packed in half or one gross box. (IDEAL FOR SCHOOL USE) Extra 10% discount on 5 gross & up.----- each .50
- #280 Arrows - 11/32 shaft, 4" fletch; length with target point, 28"; length with field point, 29". Extra 10% discount on 5 gross & up. ----- each .55
- #290 Arrows - 11/32 shaft, matched in spine to 10 lbs., 5" fletch, 32 1/2" length, or tapered for broadhead. Packed in 1 gross box. Extra 10% discount on 3 gross & up. ----- per doz. 8.50  
Available with target, field point, or broadhead. ADD PRICE OF POINT OR HEAD
- #350 Arrows - 5/16 or 11/32 shaft with 5" helical 3 fletch, matched in spine, 5° taper for broadheads. (Not Matched in Grain Weight)-----per doz. 10.00
- #350 Arrows - with BEAR RAZOR HEAD----- per doz. 14.95



FOR 500 gr. ELK WEIGHT ARROWS, ORDER #400

- #400 Arrows - Our finest wood arrows, 5/16 or 11/32 shaft, matched in weight and spine, helical 3 fletch, full length or cut to length with 5° taper. -----per doz. 12.00
- #400 Arrows - with BEAR RAZOR HEAD ----- per doz. 16.95

**Martin's Special Aluminum (Swift) Arrows** - 3 fletch helical target or hunting --per doz. 23.95  
Available in sizes: 1316, 1616, 1716, 1718, 1816, 1818, 1916, 1918, 2016, 2018, 2020, and 2219.  
Extra 10% discount on 12 doz. and up.

- Martin's Easton Aluminum 24 SRT X-3 fletch, helical ----- per doz. 29.50
- Martin's Easton Aluminum XX 75 - 3 fletch, helical ----- per doz. 34.50
- Martin's Easton Aluminum X7 - 3 fletch, helical (Available in 1614, 1616, 1714, 1716, 1814, 1816, 1914, 1916, & 2014) ----- per doz. 39.50

- Martin's Micro-Flite Glass Arrows - 3 fletch, helical, target or broadhead adaptor - per doz. 28.50  
with field point ----- per doz. 29.50  
(Add \$2.00 extra per dozen for four fletch.)



- Flu Flu Arrows Full length without point----- each 1.25
- Rabbit Arrows -4" fletch, matched in spine to 5 lbs., 5° taper, without points ----- per doz. 4.95
- Solid Glass Fish Arrows ----- each 2.50
- Cross Bow Arrows - ----- Field, each .75 ----- Hunting, each 1.25



No. BH Forgewood BATTLESHAFT HUNTING 17.95 doz. plus price of broadheads



3 for \$2.00

BOW BIRD is a 3-dimensional target of tough cardboard approximately 15" in diameter. It is thrown into the air with a spinning motion. Shot with flu-flu type arrows on any baseball-diamond-size area. It's great practice for all moving targets.

**FOR RUSH ORDERS, CALL**  
**1-509 / 529-2554**

# Martin's

BOWS

Rosewood and Bubinga  
Handle Risers provide  
the utmost in  
Performance,  
Strength,  
and Beauty.



*Martin MX 800*  
69'' or 66''  
Rosewood Handle Riser  
\$115.50

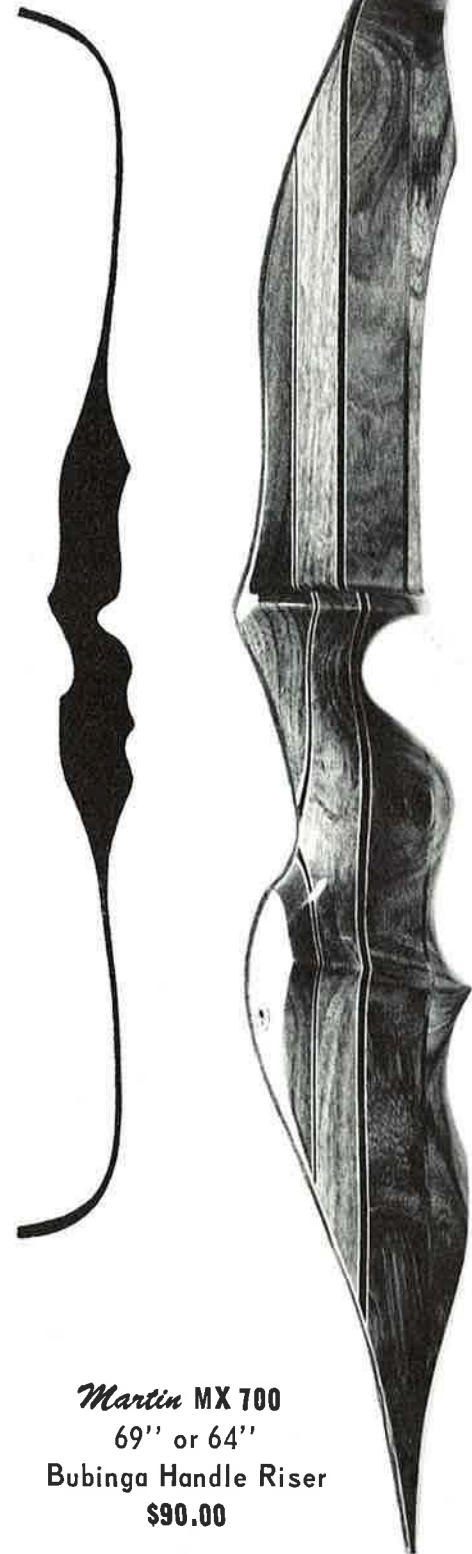

*Martin MX 700*  
69'' or 64''  
Bubinga Handle Riser  
\$90.00

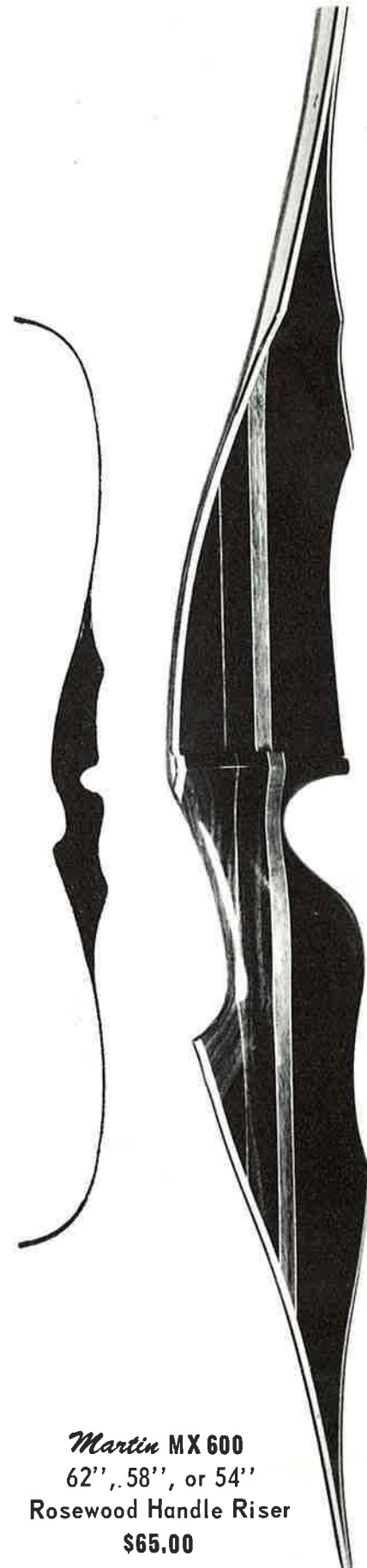

*Martin MX 600*  
62'', 58'', or 54''  
Rosewood Handle Riser  
\$65.00



*Martin MX 500*  
60''  
\$43.50

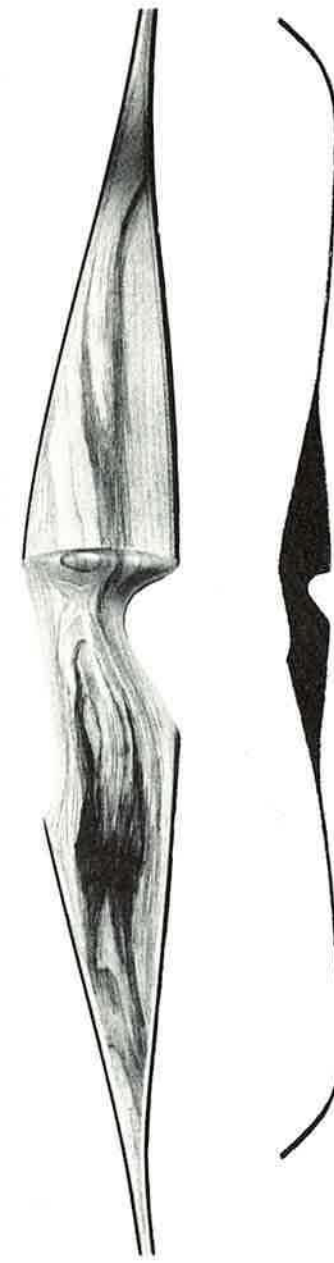

*Martin MX 400*  
62''  
\$29.50

Target or Hunting Weights to 70 pounds.

- Custom Handles - 3M Glass -

**BEAR RAZOR HEAD**

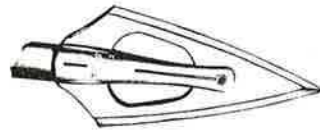

Heads with inserts ----- \$6.25 per doz.  
 Heads only ----- \$4.95 per doz.

**On Display Cards**  
 Also available in bulk to arrow manufacturers

**BEAR INSERTS**



\$1.35 per doz.



**BOWLO BROADHEAD**  
 \$5.95 per doz.  
 115 GRAINS



125 gr. SHOCKER  
 \$4.00 per doz.



**SUPER HILBRE HEAD** Price \$6.95 per dozen.  
 1 1/8" wide.



**PEARSON BROADHEAD**  
 5/16 - 140 gr.  
 11/32 - 160 gr. \$7.00 per doz.

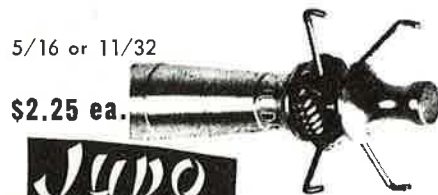

5/16 or 11/32

\$2.25 ea.



**HUNTING POINTS**

Illustrations not relative in size.

**The H.T.M. SMALL GAME HEADS**

(RUBBER BLUNTS)  
 KILLS BY SHOCK

HTM STANDARD - 125 Grains \$2.00 per doz.  
 HTM JR. SIZE - 65 Grains --- \$2.00 per doz.



M-A 3 BLADE

5/16 (100 grains), 11/32 (125 grains).

List price \$3.95 doz.

**ROSE Arrowmate**



**4 BLADE**  
 \$5.00 per doz.

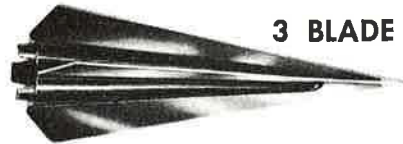

**3 BLADE**

\$6.50 per doz.

STATISTICS: 1 1/8" cutting circle, 3" long, tempered spring steel, glue tabs, 115 grains, reinforced point.

**CAT-CLAW**



\$7.00/doz.

• Dimensions - 1 1/4" X 2"  
 • 130 gr.

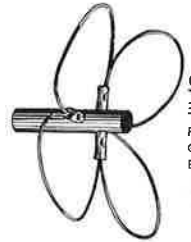

**GAMELANDER**

3" DIAM.  
 FOR SMALL GAME AND BRUSH SHOOTING  
 \$1.75 EACH



125 gr. **BLACK COPPERHEAD SLICER** \$7.00 per doz.



**ACE SUPER EXPRESS**  
 \$7.50 per doz.

**ACE SUPER IV**  
 \$12.00 per doz.



**Match-All ARROW POINTS**

AVAILABLE IN ALL SIZES



**FIELD POINT - Taper Hole**  
 \$1.00 Doz., \$7.00 per 100)



**TARGET POINT - Taper Hole**  
 \$1.00 Doz., \$7.00 - 100)



**BLUNT POINT - Taper Hole**  
 80c Doz., \$6.00 - 100)



**TARGET POINT - Parallel Hole**  
 80c Doz., \$6.00 - 100)



**HEADSHRINKER - Aluminum**  
 \$1.00 Doz., \$7.00 - 100)



**FLIGHT POINT - Brass**  
 \$1.25 Doz., \$8.00 per 100  
 5/32 O.D. 1/8" Parallel Hole  
 4 grains



**BLUDGEON BLUNT** for birds and small game -- rubbery plastic head "gives", glances off rocks, trees, etc. Kills by shock. Fits 5/16" or 11/32" shafts.

Bag of 5 . . . \$1.00

**Panther IV**



**Panther IV**

A four - blade broad-head with side cutters for greater effectiveness. Finest quality spring steel.

125 grains \$4.50 dozen

**"BOD-KIN" THREE-BLADED POINT**

HOLLOW GROUND - 5° TAPER - COPPER BRAZED

11/32"-125 grain

• Price \$3.95 doz.



**HI-PRECISION 3-BLADED BROADHEAD-5° TAPER**

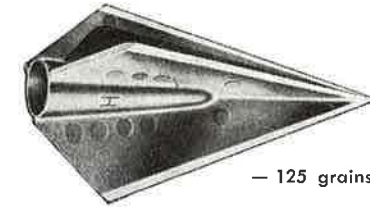

- 125 grains

• \$3.95 doz.

**#705**

An easy way to sharpen broadheads.

**BROAD-HEAD SHARPENER**  
 2.00 ea.



**BOW REELS**

DELUXE 4 1/2" \$2.95  
 CUSTOM 6" 3.50

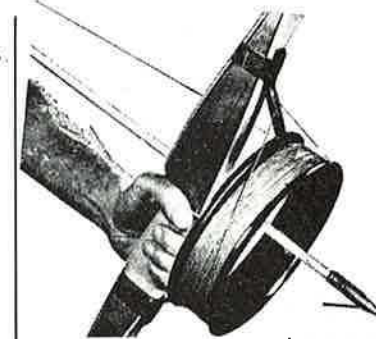

• 7" diameter \$3.95  
**"SHOOT-THRU" REEL**



**NEET Broadhead File**  
 Molded, Plastic Case  
 5 1/2 in. long  
 \$1.75



Single Barbed, One Piece Harpoon Point . . 65¢ ea.

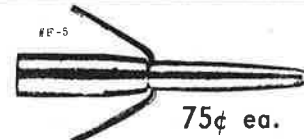

75¢ ea.

Good steel FISH POINT with very strong wire barbs. Take-apart design for easy removal from fish. Long slender nose for penetration.



**AL'S FISH-SLICK**  
 \$1.75 - 5/16" I.D.  
 • New retractable fishing point with moving barb  
 • No need to disconnect line from arrow

**MOHAWK FISH POINT**

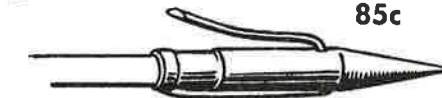

85c  
 • 250 grains • 5/16" parallel hole  
 • Barb can be reversed for easy removal from fish

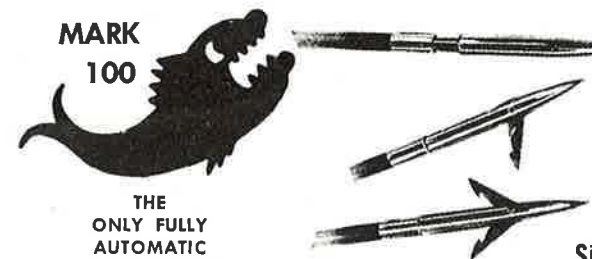

**MARK 100**

THE ONLY FULLY AUTOMATIC FISHING POINT

• Opening force adjustable by bending blades

**"AQUA KILLER"**

• Maximum holding ability  
 • Made of finest quality stainless steel  
 • Guaranteed rust proof and salt water proof  
 • Opens instantly on contact!  
 • Simply close blades to remove from fish

Single Blade .... \$2.50 each  
 Double Blade ... 3.50 each

#444 . . . \$14.50

# 444 **FIELDMASTER** For roving or target. Newly designed with flared out contour for a soft hip hugging fit. Slotted top for 1 1/2" contoured belt. Large zipper pocket 7 1/2 x 3 1/2 x 1 1/4". Holds 6-8 arrows. Made of top grain cowhide leather. Sturdy construction. Colors: Black, Brown or White. Right or left hand. **\$12.95**



#446 **Roving or target quiver**  
Flat Style. Newly designed belt loop for better fit and style, plus new pencil pocket. Large zipper pocket 7 1/2 x 3 1/2 x 1 1/4". Holds 6-8 arrows. Made of top grain cowhide leather. Sturdy construction. Colors: Black, Brown or White. Right or left hand. **\$12.95**

**MATCHING BELTS**  
**TOP GRAIN COWHIDE**  
1 1/4" Black - Brown - White  
#700 contoured. **\$3.25**

**Martin**

8" x 12" x 37"  
**ARROW AND**  
**ACCESSORY CASE**

- Holds 24 Arrows
- Vinyl Covered Case
- Chrome Corner Bumpers
- Lower Section for Accessories

..... **\$34.50**

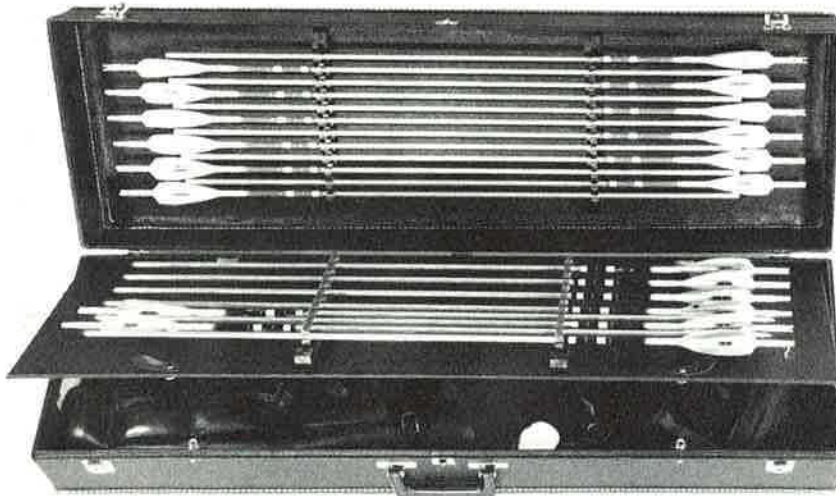

#405



#409



#412



#483

#405 **Selected top grain leather**

Large pocket for score card. Two straps with belt clips. Divider strap for 2 division quiver. Easily holds 12 arrows. Right or Left hand. Colors: Brown - Black - White . . . . . **\$9.00**

#408 **Quiver**

Same as No. 409 TARGET KING except 2" shorter and all white. . . . . **\$14.50**

#409 **Target King**

Selected top grain leather. Large zipper pocket 8 x 3 1/2 x 1 1/4". Two belt clips. Pencil pocket. Divider strap for 2 division. 20" long. Top opening 4 1/2 x 2", bottom 3 1/2 x 1 1/4". Black or Brown. Specify right or left hand. . . . . **\$14.50**

#412 **Rangemaster**

Designed to hold quiver at proper angle. Pencil pocket. Zipper pocket 8" by 4" by 1 1/4". Divider strap. Length 20", top opening 4" by 2", bottom 3 1/2" by 1 1/2". Easily holds 12 arrows. Color: Brown Specify right or left hand. . . . . **\$18.75**

#415 **Quiver**

Same as No. 412 RANGEMASTER except 2" shorter and all white. . . . . **\$18.75**

#483 **Target style quiver**

Heavy weight expanded vinyl. Ring and belt clip. Divider strap for 2 divisions. Holds 12 arrows. Small flat accessory pocket. All trim and straps in grain leather. Black or white. 19" long. Specify right or left hand. . . . . **\$5.95**



#428  
**\$26.00**



#426  
**\$22.50**



#421  
**\$22.00**



#418  
**\$16.95**



#489  
**\$7.95**

#428 Large 2 division quiver. Top grain cowhide. 20 1/2" long. Will hold 24 arrows. Large zipper pocket & knife pocket on side. Black only. Right or Left hand.

#426-S Large 3 division center back style quiver. Tough split cowhide. Length 21 in. Black only

#421-S Large 2 division shoulder quiver. Tough split cowhide. Length 20 1/2 in. Black only. Right or Left hand.

#418 Same material and trim as No. 421. 18" long, for shorter arrows. Black only. Right or Left hand.

#489 Large shoulder quiver of tough, heavy gauge vinyl. Zipper pocket, moulded bottom. Holds 18 or more arrows. 19 1/2" long. Right or Left hand.

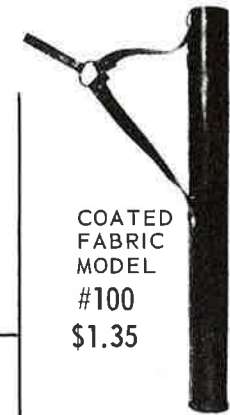

COATED  
FABRIC  
MODEL  
#100  
**\$1.35**



#492  
**HIP POCKET**  
**QUIVER**  
10"  
Black Only  
**\$2.25**

#442 Quick Action hip quiver. Holds 6 arrows in moulded rubber clips. Made from rugged bonded vinyl. . . . . **\$8.25**

*Hunting*

**QUIVER**



#442  
**\$8.25**  
matching  
#700 Belt  
**\$3.25 ea.**



#440  
**Only**  
**\$11.50**

1 1/2" Wide  
Matching Belt.  
Blk., Brn., Wht.  
#700, **\$3.25**



**HIP**  
*Quiver*

#445-S  
**ROVER**

Flat style hip quiver. split cowhide leather. Firm belt loop to hold quiver at proper angle. Pocket with flap and heavy snap. Pocket size 6 1/2" taper to 4 1/2" deep, 3 1/2" wide, 3/4" high. Holds 6-8 arrows. Divider loop to separate arrows. Black only. Belt not included.

**\$7.95**

1. HOLDS MORE ARROWS
2. KEEPS ARROWS FREE OF BRUSH
3. ABSOLUTELY QUIET
4. STAYS OUT OF THE WAY
5. ARROWS INSTANTLY AVAILABLE
6. KEEPS BROADHEADS DEADLY SHARP
7. EXTREME LIGHT WEIGHT DESIGN
8. FULLY ADJUSTABLE
9. ULTRA FAST ARROW DRAW
10. STURDY LIFE TIME CONSTRUCTION

# KING FINEST QUALITY Gloves



**#226 Ladies All White Glove . . . . . \$2.95**  
Soft form fitting. Closed end tips. Top grain leather. Elastic back. Ladies sizes only.



**#227 Top Grain Cream Color Leather \$2.95**  
Adjustable wrist strap. Elastic insert back. Soft form fitting closed end tips. Lets you feel the string. Men and ladies sizes.



**#210K Top Grain Leather Glove . . . \$2.00**  
One piece back. Open end style tips. Men and womens sizes.

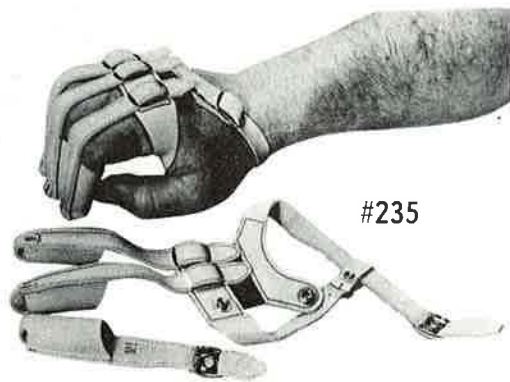

**#235 Fully Adjustable Glove . . . . . \$4.50**  
Individual finger length adjustment. Adjustable palm strap eliminates glove twist. Elastic insert maintains a perfect working tension. Men sizes only



**#225 Soft Llana Glove . . . . . \$2.45**  
Form fitting cream cowhide. One piece back Soft closed end tips. No breaking in. Men and ladies sizes.

**GLOVE SIZES:** Men: Small, Medium, Large, Ex-Large  
Ladies: Small, Medium, Large

• **WOLVERINE "BULLSEYE"** •  
NEW 3 FINGER GLOVE  
\$3.50 each

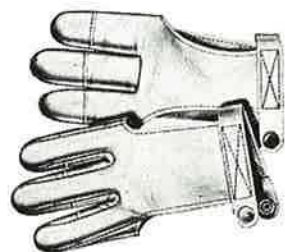

SMALL	9
MEDIUM	10
LARGE	11

With NEW Velcro Fastener

- Made of genuine deerskin leather — for the ultimate in flexibility and long wear.
- Pull tape fastener to insure closeness of fit.
- Imported Persian grain goatskin tips for extra-wear and smooth jet-fast releases.
- The ultimate in hand-finger protection.
- Flexibility assures proper "feel" of the string — will not groove like hard cordovan tips.



**#316 Economy Leather Glove. \$1.50**

**#302 Plastic Arm Guard.**  
Ideal for school and camps  
Color --- black. . . \$ .60

**#300 Pouch . . . . . \$6.95**  
Top grain leather belt pouch. Zipper closed. Belt loop. Size 6½ x 4 x 2. Color: White or Black



**FOR RUSH ORDERS, CALL**  
**1-509 / 529-2554**

# Guards

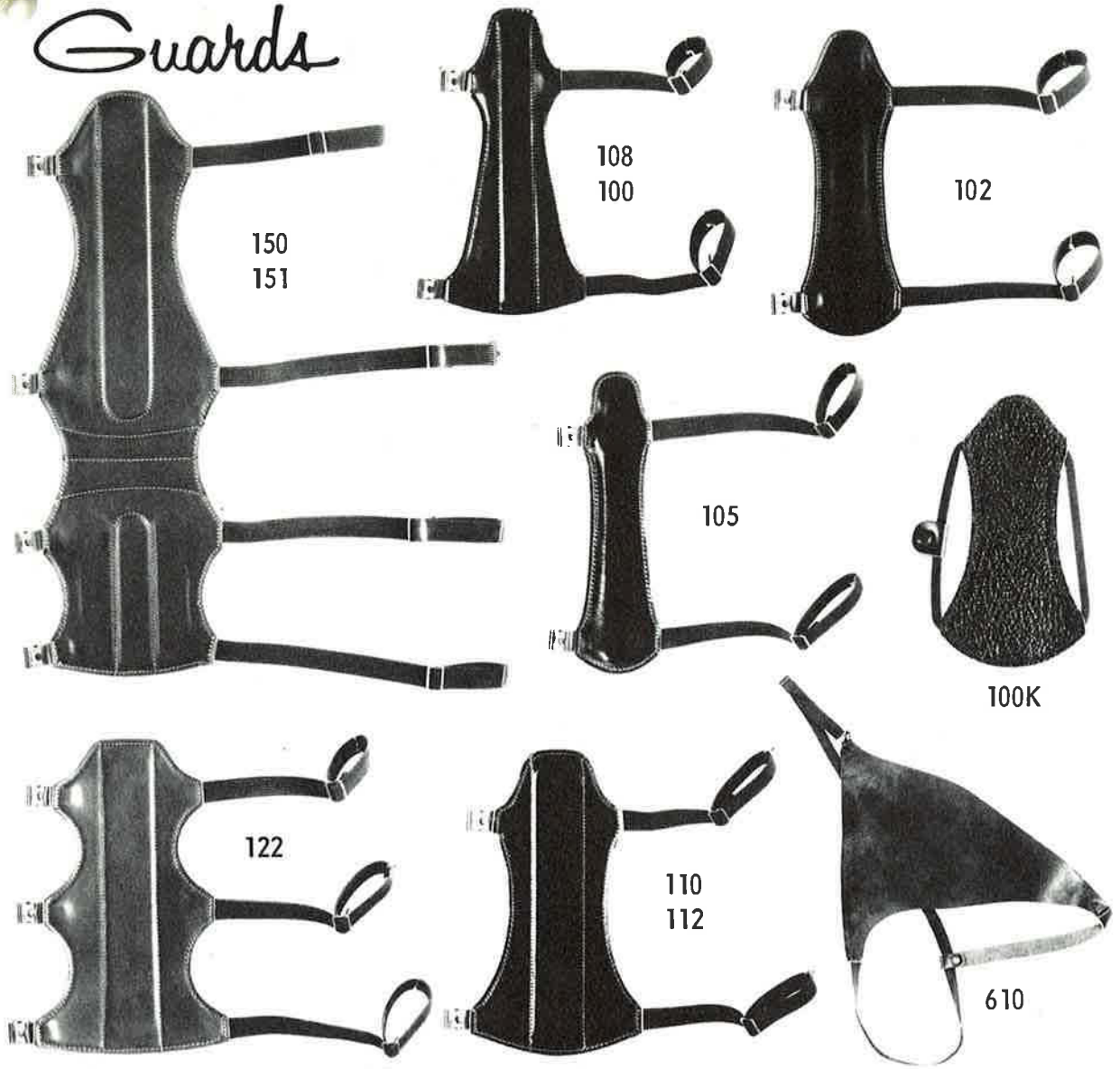

**#150 For Hunting or Range**  
Full arm protection. Four adjustable elastic straps with metal fittings. Spring steel inserts at both ends flexible enough to bend at elbow. Leather lined. Material is tough vinyl covered cowhide. 13" long. Color: Black . . . . . **\$4.15**

**#151 Same as #150, only shorter**  
Same style and construction as 150 except 11 in. long. Color: White . . . . . **\$3.85**

**#122 Hunting Style extra wide**  
Three adjustable elastic straps. 1" steel insert. Leather lined. Material is tough vinyl covered cowhide. Colors: Black or Brown. . . . . **\$3.10**

**#108 Regular Style**  
Two adjustable straps with metal fittings. Leather lined. Material is tough vinyl covered cowhide. Spring steel insert. Three colors: Black, Brown, or White . . . . . **\$1.90**

**#100 Corfam Regular Style Guard**  
Two adjustable elastic straps with metal fittings. Spring steel insert. Leather lined. . . . . **\$2.25**

**#105 Corfam Narrow Style Guard**  
Two adjustable elastic straps with metal fittings. Spring steel insert. Leather lined. . . . . **\$1.95**

**#110 Very popular Wide Style Corfam**  
Two adjustable elastic straps with metal fittings. 1" spring steel insert. Leather lined. . . . . **\$2.75**

**#112 Wide Style**  
Two adjustable elastic straps with metal fittings. 1" steel insert. Leather lined. Material is tough vinyl covered cowhide. Color: Black . . . . . **\$2.10**

**#102 Semi Narrow Style**  
Vinyl covered material. Leather lined. Spring steel insert. Color: Black only . . . . . **\$1.40**

**#100K Inexpensive Style Guard**  
Cowhide material. Spring steel insert. Lined. Two elastic quick action loops with hook fastener. **\$.95**

**#610 Chest Guard**  
Top grain leather. Leather strap over shoulder fastened to adjustable elastic chest strap. Color: Black only. Large. Right or Left hand. **\$3.95**

**WILSON POWDER POUCH**

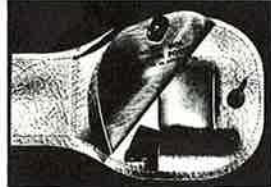

**\$1.25**

- Made of white heavy-duty "rhino" finish plastic
- Keeps powder dry and handy
- Snaps around belt — has protective cover
- Easily applied by patting dispensing section
- Convenient place to carry pencil — pencil pocket
- Easy to fill thru top opening — refillable

**WARNE'S  
CUSTOM BOW-SLING  
\$2.50**

- Perfect balance with any shooting style
- Easy on and off bow hand
- No screw holes to deface bow
- Top grain cowhide — natural color
- Leather can successfully be dyed to suit taste
- Easily molded to bow contour — won't slip
- Complete instructions with each sling



**ARM GUARD**

"Action Guards" are molded of flexible plastic to a contoured shape that really fits your arm — no more frayed edges to deflect your string. Black or white — **\$2.25**



**BOW-SLING**

No. S-2  
**\$1.25**



**3 in 1  
POWDER POUCH**

Nylon Stitching, Belt Clip, Pencil Holder, and Score Card Holder.

Colors: Brown, Black, White, White Bark, and Blue.

each . . . **\$2.50**



**MOHAWK  
GLOVE POWDER**

- Friction free powder 50¢
- New plastic "puff" bottle

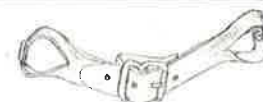

*Martin*  
New, Adjustable  
**FINGER SLING**  
**\$1.95 ea.**

**BJORN TABS**



**HAIR FACE**  
**\$3.50 ea.**

Small  
Med.  
Large  
EX-Large

Right or  
Left hand



**#252 King Tab**  
Single thickness top grain cowhide . . . . . **\$1.40**

**#254 King Tab**  
Double thickness, Corfam with vinyl facing. Vinyl is expanded to give extra protection and ease of shooting . . . . . **\$1.00**

King Tabs are made in four sizes: X Small, Small, Medium, and Large. Specify right or left hand.



**Wilson Tab**  
Sizes: Small, Medium, Large. Right or left hand.  
. . . . . **\$1.50 ea.**

**Cool Nylon Mesh  
CHEST PROTECTOR**

Black or White  
Left or Right  
Small or Large

**\$6.95**



**BOW SADDLE**  
**\$1.00**



*National* "SNAP-ON" Bow Quiver  
**NOW HOLDS 5 ARROWS**  
**\$2.95 pr.**

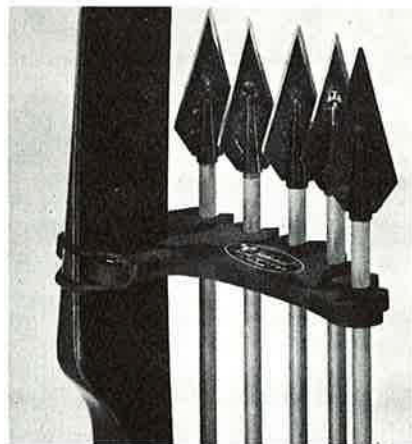

**Kwik-Kwiver**

The lightweight bow quiver that snaps on and off in seconds. (6 pair to a display carton.)  
**\$3.50 pr.**

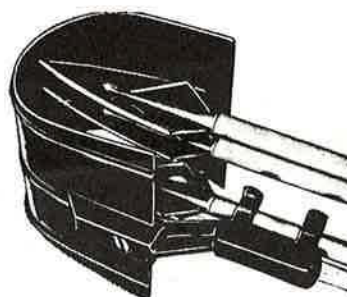

**KWIK-KOVER** **\$1.50 each**

- Featherweight broadhead shield
- Moulded from tough, super-impact "Cyc-lac" thermal setting plastic
- Attaches to spare arrow mounted in Kwik-Kwiver by plastic coated non-mar spring clips
- Assures positive protection from exposed blades
- Also protects blades from dulling contact with any object
- Does not interfere with normal removal of arrows while hunting
- Stabilizer bar on stem prevents twisting on arrow

**CATQUIVER**



Kamo Cover  
**\$15.95**



100% Fur Cover  
**\$21.95**

**CATQUIVER** holds 12 or more arrows, adjusts to all arrow lengths, is completely safe and affords easy access to arrows, is waterproof and light weight, has a wrapover pouch which holds extra tackle, and has adjustable straps for custom fit.

**BQ-7 BOW QUIVER** (U.S. Patent No. 470,082)  
-Carries seven arrows -Torsion-grip holds securely in place  
-Fits all hunting bows -Detaches instantly

No. BQ-7 Individually boxed bow quiver for right hand shooters **\$14.95**  
No. BQ-7L As described except for left hand shooters----- **\$14.95**

**GROUND QUIVER  
(ALUMINUM)**



Holds 12 Arrows  
**No. 56** each **\$1.25**



Knock down type - holds bow and arrows.  
**No. 57** each **\$2.95**

**"SILENT SIX" Bow Quiver . . .**



**No. 1010 . . . per set \$1.95**

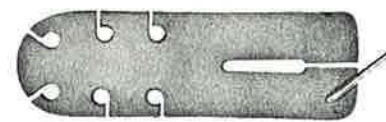

**No. 1011 . . . per set \$2.75**

**MATCH 300**

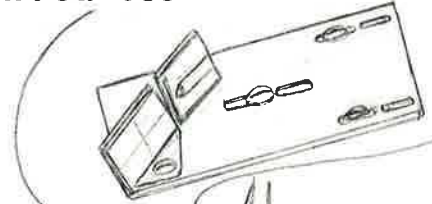

**DRAW CHECK**  
With the MATCH 300 your arrow draw is always readily visible.

**MOUNTING**  
The MATCH 300 is easily mounted on any modern recurve bow with or without stabilizers.

**YARDAGE**

The MATCH 300 lets you reach yardage formerly attained only by using a prism.

**FOCUS**

The MATCH 300 puts the target and sight images together and allows a sharper image of target & crosshair.

\$44.95

**BOW HAND TORQUE**

The MATCH 300 completely revolutionizes all target shooting by optically correcting or compensating for bow hand torque, and heeling.

**NO DISTRACTION**

Other archers' targets are no bother because you may isolate your target.

**PRISMATIC EXAGGERATION**

The MATCH 300 does not exaggerate error if you cant the bow.

**Martin's No. 505 BOW SIGHT**

\$4.95

• Positive - Windage and Elevation locks

• All metal construction

• 2 sizes 7 1/8" and 6" lengths

• Scale or Tape Model

• Assured Accuracy

• Colorful Anodized Aluminum

**APERTURES**



**VEE BOW SITE**

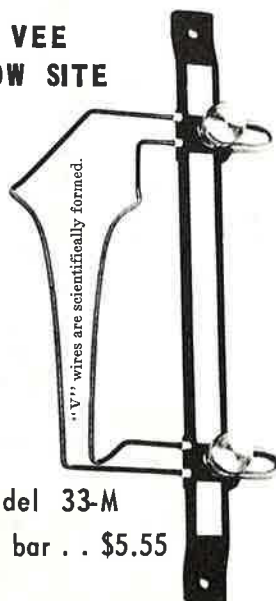

Model 33-M

7" bar . . \$5.55

**D-J (patented) bow sight**

without yardage corrector \$7.95

with yardage corrector \$9.20 (as pictured)

D-J Windage Adjustor \$2.00



**SIGHT WITH A MEMORY**

\$19.95

• Satin black plastic

The ASP-100 brings to the archer for the first time, one of the oldest principles in sighting, adjustable sighting plane, precision built, yet designed to be simple to use.



\$5.95

**NEW ALL METAL SAUNDERS HUNT-MATE SIGHT**

Attachment tape included

- Colored Aiming Dots
- 4 Independent Heads
- Fits All Bows

**FLEETWOOD BOW SIGHT**



No. 650

Fleetwood Bow Sight. Each... \$1.50

**MICROME No. 1001 Hunting Site** complete with 3 fully adjustable bead posts, black, copper, and cadmium. Set the posts at your choice of distance each \$2.95



#243 Pin On COMPASS . . . \$1.95

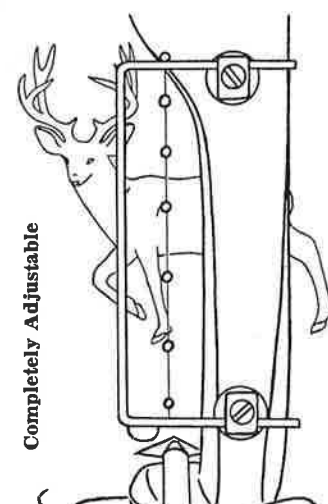

**VAN'T HUL BEAD SIGHT** \$2.95 ea.

Completely Adjustable



**REYNOLDS DOUBLE ADJUSTMENT BOW SIGHT** \$8.75

Reynolds Adjustable SIGHT EXTENSION \$7.95

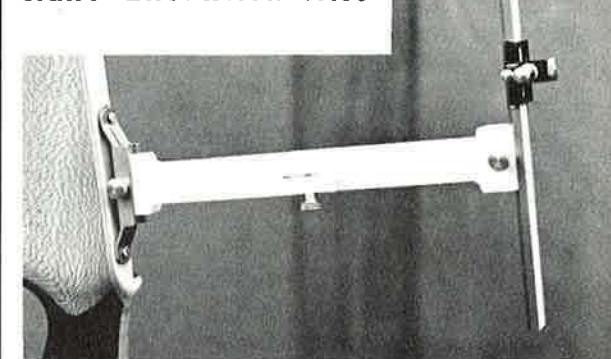

**"CHAMPION" BOW SIGHT EXTENSION** • 6" EXTENSION FITS REYNOLDS SIGHT \$7.95



**REPLACEMENT PARTS FOR REYNOLD'S SIGHT**

RS- 1	Body	-----	\$2.00
RS- 2	Lock Nut	-----	.20
RS- 3	Prism Screw	-----	.35
RS- 4	Mounting Screws	-----	.15
RS- 5	Slide Body	-----	2.50
RS- 6	Spring	-----	.35
RS- 7	Sight Screw	-----	.60
RS- 8	Lock Screw	-----	.40
RS- 9	Base w/Screw	-----	3.55
RS-10	Washers	-----	.15

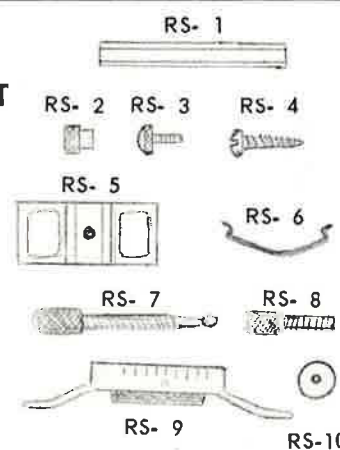

**Merrill Bow Sight**

U. S. PAT. 2,875,522

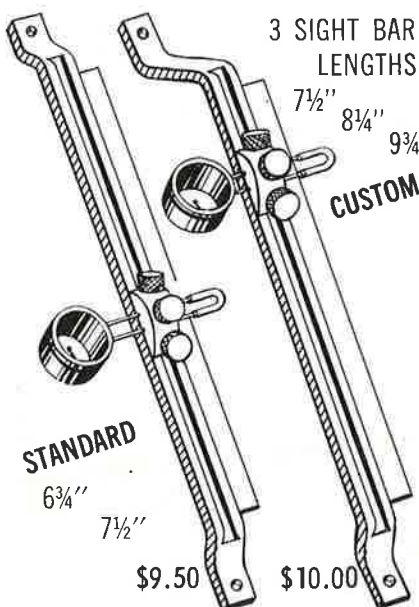

STANDARD 6 3/4"

7 1/2"

\$9.50 \$10.00

**PIN DOT HOODED SIGHT RINGS**



\$1.00 ea.

**"LITTLE BEAUTY"**

\$1.00

**PEEP SIGHTS**

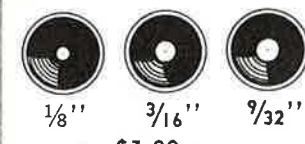

\$1.00 ea.

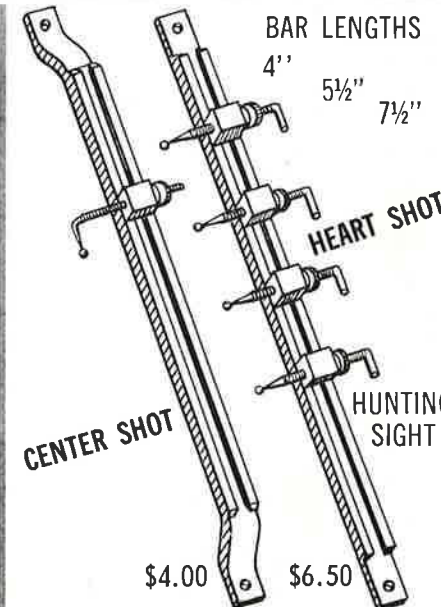

CENTER SHOT \$4.00

HEART SHOT \$6.50

HUNTING SIGHT



FLETCHER  
PERFECT PEEP SITE

\$1.00

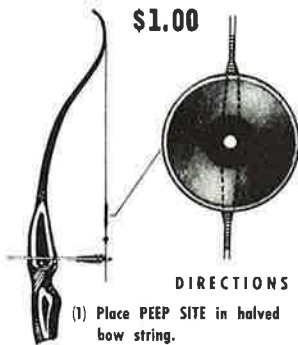

DIRECTIONS

- Place PEEP SITE in halved bow string.
- String bow and adjust PEEP SITE for full view of bow window and serve.

GOODYEAR  
STRING SIGHTS

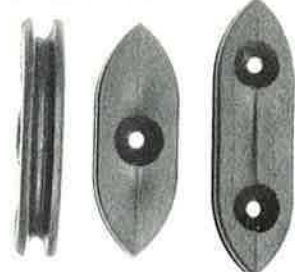

1/16" hole 85¢ each

GOODYEAR  
SLOTTED  
STRING  
SIGHT .85 ea.



Wrist Rocket  
HUNTING SLING



A powerful weapon, an exciting target shooter, popular with young and old alike. For power, accuracy, easy handling, this sling is in a class by itself.

No. WR1—General purpose model pulling weight 25 lbs. Packed 6 to carton ..... ea. \$2.95

No. WR2—Hunter's model, pulling weight 35 lbs. Packed 6 to a carton ..... ea. \$2.95

REPLACEMENT RUBBERS

No. 1RR—Standard rubbers with pouch attached .....ea. .95

No. 2RR—Extra heavy rubbers, standard pouch attached .....ea. .95

Potawatomi  
BOW SQUARE

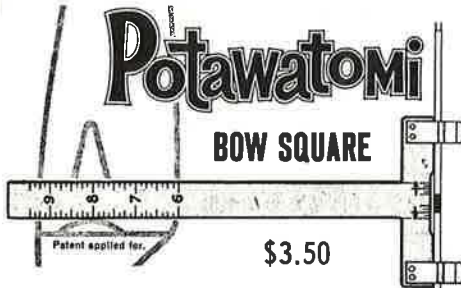

\$3.50

NOK-SET

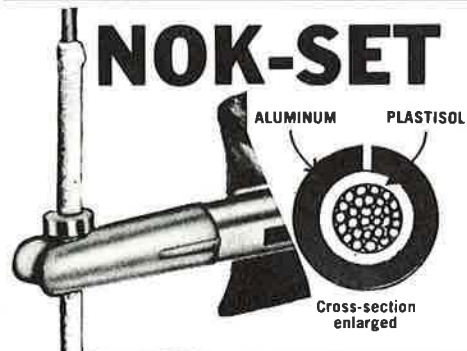

Cross-section enlarged

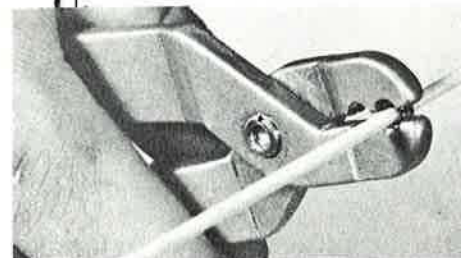

Box of 100 NOX - SET \$15.00

Pliers only ----- \$1.00

No Glov

Molded rubber, contoured for perfect finger fit. Eliminate need for glove or tab. Provide fast, accurate shooting no matter the weather. Positive nocking point. (12 on display card.)



.....\$1.00

Kwiikee-Silencer

Eliminate bow string noise. A must for the hunter. (12 pair on a display card.)



\$.90 pr.

STRING SILENCER

39¢ PAIR

12 on display card.

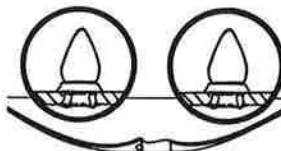

NEW KILBEAD BOWSTRING SILENCER

\$.75 pr.



NEW SAUNDERS  
MARK 3  
BOW SQUARE

Simple, easy to use Saunders Bow Square measures fistmele and indicates proper nocking point on the string. Sturdy, light-weight aluminum, the tool has no moving parts to get out of whack. All of the squaring surface is below the nock, making it possible to check an old nocking point without removing it or the kisser. Toe of Square indicates the arrow position and nock point is usually put just above the arrow. Each .....\$3.50

Only \$2.50 String GAGE

- Easy to read
- Pocket or belt clip
- Positive alignment

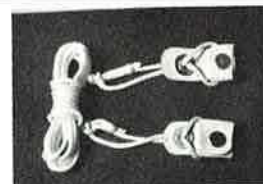

Bow Pal  
BOWSTRINGER  
each . . . . \$2.40

HEAT NOCK  
NOCKING POINTS



Packed 4 per pkg.  
50¢ pkg.  
One doz. pkgs.  
mounted on card

BULK \$8.50 per C

Nock-Lock

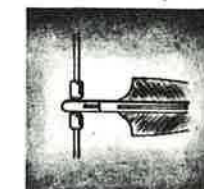

(12 on a display card.) .....\$ .50 pr.



\$1.00

Pat. Pend.

"Kisser" Button



50¢ each

Doz. on Card

Brush Buttons



Brush-proofs your bow and quiets the string noise. Made of soft rubber, easily attached and does not interfere with bracing or shooting.  
Regular .....\$.60 pr.  
Super .....\$.70 pr.



HOYT  
KLICKER  
\$1.25

"Fletch Site"



75c  
each

Site Thru Your  
Bowstring!

BUBBLE SIGHT

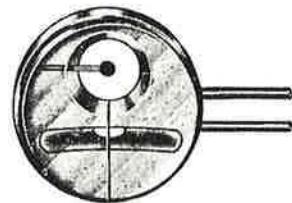

ACTUAL SIZE

— ORDER THE BUBBLE SIGHT TO SUIT YOUR BAR —

Model No. 804-P for any two pin sight .....\$5.95

Model No. 8-32 for Reynolds, Accra, and 8/32 screw ..... 5.95

- Improve your score by shooting a level bow
- 5 degrees off level is a "sure miss"
- Sight of shock proof plastic, heat treated pins and welded constructed ring
- Total weight 1/7 of an ounce
- Will not move or jar on release
- Blue bubble stands out in any weather
- No need to shift vision — see both at once
- Gain new accuracy with sight pin and bubble in small area

GOODYEAR SIGHTS

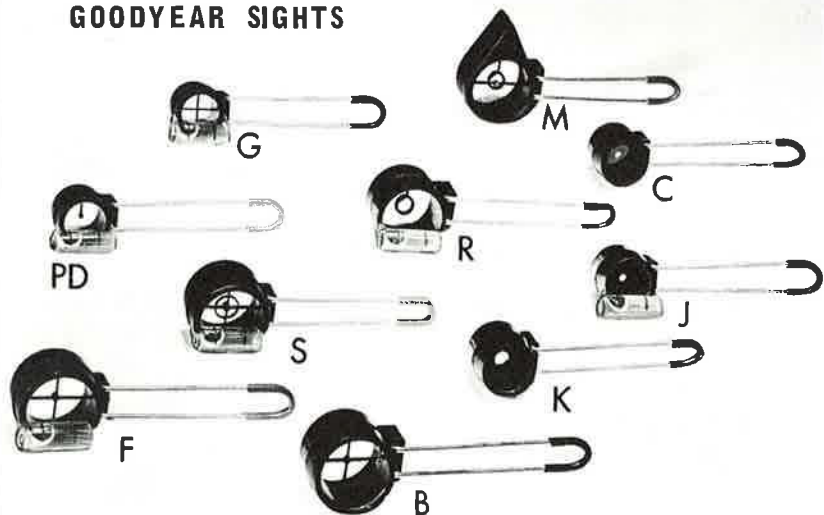

Small Sights are 3/8 dia. hood  
Large Sights are 5/8 dia. hood  
Orange fluorescent pin or post

GOODYEAR SIGHTS

B Large Cross Hair \$1.75  
C Peep Sight . . . . . 1.75  
M Pendulum . . . . . 4.00

SIGHTS WITH LEVELS

G Small Cross Hair . . \$2.75  
F Large Cross Hair . . . 2.75  
J Peep Sight . . . . . 2.75  
PD Small Drop Pin . . . . 3.00  
R Ring Sight . . . . . 3.00  
S Combination Sight . . . 3.00

EXTRA WIRE . . . 50¢

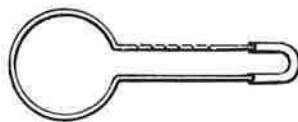

Wires have notches  
for windage reference.

VICTOR PRISM

Hooded \$7.50 ea.

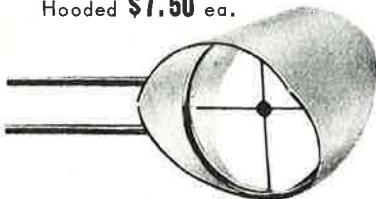

Victor Prism comes in  
0°, 2°, 4°, 8°, 12°  
with or without hood.

Without Hood  
\$6.95 ea.

**MAX HAMILTON HAND LOCATOR \$2.00**

Your hand will automatically go to the same spot each shot with this two piece locator.



**BOW LEVEL 85¢**



**ADJUST-A-LEVEL**

Attach to bow limb  
Set level to suit  
Tighten screw  
May be re-set  
each **\$1.50**

**KWIK-LOK ARROW READY**

- HOLDS YOUR ARROW IN THE BOW...
- RELEASES INSTANTLY WHEN YOU DRAW!

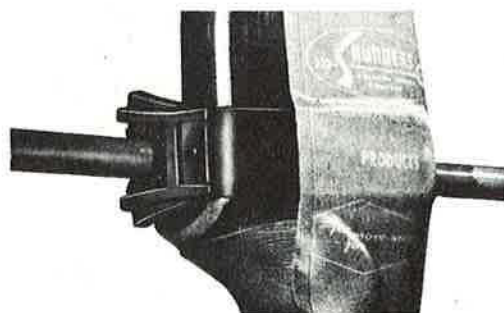

**INDIVIDUALLY CARDED • ONLY \$2.00**



**THE NEW MARK III PARA-REST by SAXON**

Featuring The New Flyer Damper And Adjuster Pad. Adheres in Seconds To All Curved Sight Windows. **\$1.00 Ea. List.** Comes to you on an attractive 12 count display.

**Stabilizer FLEX-CONNECT \$9.95**



**Custom Stabilizer**

**EFFICIENT EFFECTIVE HANDSOME**

21 1/2" length, 8 ounces  
17 1/2" length, 7 ounces  
**12.50 each**  
5/16" insert 1.50

**MARTIN ADJUSTABLE STABILIZER each \$12.95**



**BOW MATE CLICKER**

This new clicker signals the archer audibly when his arrow reaches full draw.

**\$1.50 each**

Clicker rests on arrow as arrow is being drawn.

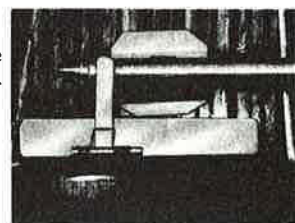

**STA-JAC ARROW CINCH**

Field tested in all kinds of weather, summer and winter.

- Holds Fast
  - Releases easily
- One doz. on Card

.. ea. **\$2.25**

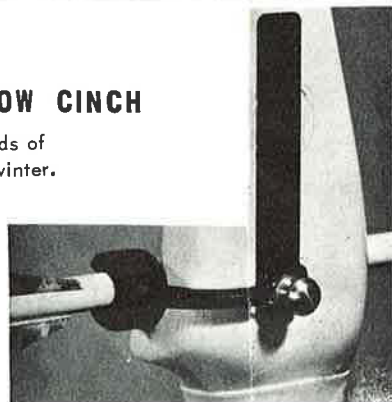

**Whisper ARROW REST \$2.00**

- Covered with calfskin hair
- Speeds up arrow flight
- Easy to attach
- Unaffected by rain or snow

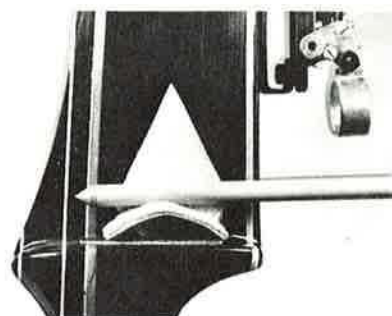

**BJORN ARROW REST**

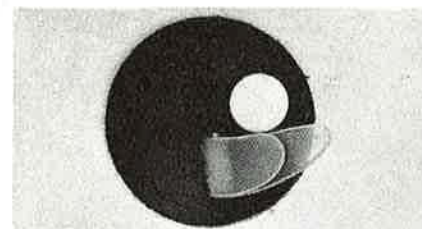

Adhesive backed plastic double flipper rest. Offers a firm support in the vertical plane and flexibility in the horizontal plane. It has a Teflon button pressure point. **each \$1.25**

**"PARA-REST" Horizontally mounted**

Top grade Nylon brush type with handsome, finished, genuine leather backing. Ideal for plastic feathered arrows. Each packaged in clear plastic, reusable box.



**75¢ each**

**PIERSON ALL-WEATHER REST**

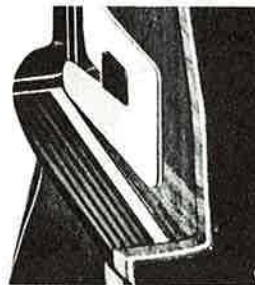

One-piece plastic - completely weather-proof. Install in 30 seconds. Permanent adhesive.

- Adjustable shelf.
- Tournament rest.
- One-Point contact arrow plate provides vane clearance.

Arrow rest as above ..... each, **75¢**

**HORIZONTAL FEATHER REST**

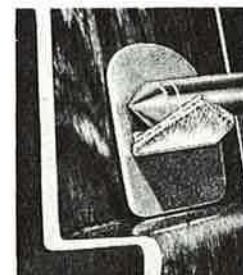

Arrow feather rest **.75**

**HAMILTON ARROW REST Two For \$1.00**



**Adjust-A-Rest**

- FLEXIBLE PLASTIC
- SELF ADHESIVE
- NO HOLES TO DRILL



Nylon side pad screws in or out for center shot adjustment!!

only **\$1.25 each**

**FLEX-REST 50¢**



- Interference free arrow shelf of special "spring" plastic.
- New advanced design increases accuracy.
- Ideal for either feathers or plastic vanes.
- No tools or cement needed.
- Self-mounting posi-stik adhesive for secure and positive attachment.
- Does not harm bow finish.

**HAIR REST**

Directional unborn calf hide as used on finger tabs. Very slick and smooth and dampens arrow noise as it leaves the bow. Very good for hunting bows. Self adhesive mounting and fits both the arrow shelf and the side of the bow.



**50¢**

**RUG ARROW REST**

Water resistant wool pile aluminum base. Long wearing. Reduces shaft and feather drag to a minimum.

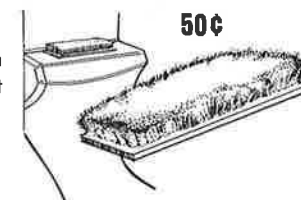

**50¢**

**HOYT PRO FLEX-REST**



Specify right or left hand **\$ 1.00**

**VERTICAL FEATHER REST**

Self adhesive and polyfoam base **50¢**



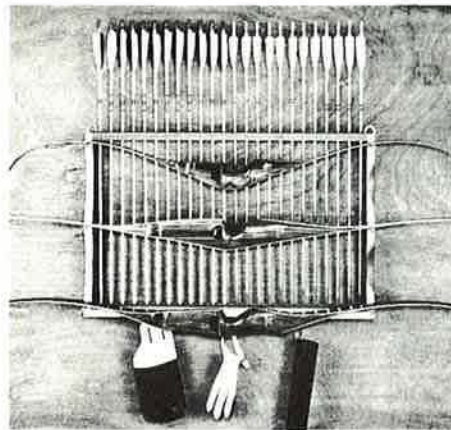

### BOW & ARROW WALL RACK

Do-it-yourself kit comes packaged complete, with instructions for fast assembly. Made of California Redwood, with metal wall hangers and special accessories hooks. Holds 6 bows and 2 dozen arrows. Grooved at rear to allow display of your enlarged club or state emblem, favorite hunting scene, etc. as a background if desired. Can be assembled in 5 minutes and finished as you please.

AN IDEAL GIFT

.....Each \$4.95

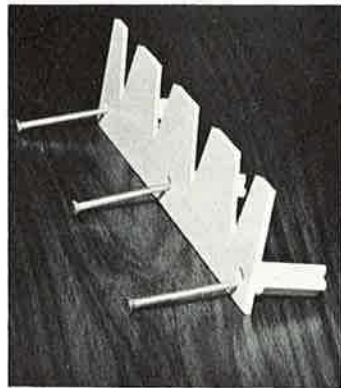

**BOW HANGER**  
High Impact  
White Styrene  
.. \$1.50 ea.

## GROVES ALUMINUM ARROW STRAIGHTENER

Pat. No. 2,876,82



\$22.95

ONE DOZEN ARROW BOX  
33" long, 6" wide, 2 1/2" deep  
100 boxes net - - - \$23.00

ARROW PADS (2 req. per bx.)  
100 pads net - - - \$3.25



### ARROW CLIPS

The perfect clip for tackle boxes, arrow display racks. Made of finest spring steel, nickel plated over copper and burnished.

No. AC—Arrow Clip and Screw.  
per gross \$6.60

6¢ each

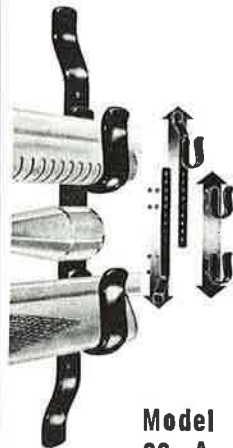

Model  
90 - A  
BOW or  
GUN RACK  
\$3.95

Additional Pr.  
Clips \$1.50



Plaque Size: 3/4 x 9 1/2 x 12 in.  
No. 475-G Emerald Green  
No. 476-R Old Glory Red  
PRICE . . . . . \$6.95



SMOK-CLIPS  
\$1.00

## NEW SAUNDERS BOW TIP PROTECTOR

ONLY  
75¢

Holds bow string in place while stringing!  
Hole allows normal action of string!

DOES NOT AFFECT BOW ACTION!  
EASY TO ATTACH

Bow Tip Protector is a neat solution to the problems of damaged bow tips. Rugged plastic, it is not damaged by sunlight, heat, cold or oils.

No. BTP-12 Dealer pack of 12  
individually carded.....\$9.00

PATENT  
APPLIED  
FOR

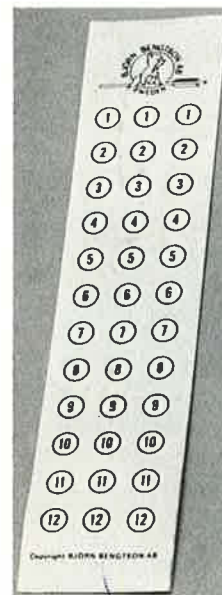

### ARROW NUMBERS

Three rows of 12 pressure sensitive adhesive transfer decals. They do not require water to apply and attach securely to the arrow surface. \$ .20

### BOWTIP PROTECTOR

50c  
each

BY THE CARD

Neatly carded. 12 Bow  
Tip Protectors to the  
card. \$6.00 per Card



INSTRUCTION BY CHAMPIONS!

45 RPM RECORD

World's Champion, Bill Dudley, and Arizona State Field Champion, Del Western, demonstrate their winning techniques and explain how to most effectively use the CIRCE calls for successful hunting. A full 11 minutes of instruction by champions.

Model R-1 \$2.00



JACKRABBIT Model P-1 \$3.00  
P-1 Jackrabbit Model Call — Extreme Long Range



COTTONTAIL Model P-2 \$3.00  
P-2 Cottontail Model Call — Long Range



HAWK Model H-1 \$3.00



TROPHY CALL P-5 \$4.00

The Trophy Predator Call has been added to the CIRCE line of varmint calls. It is one full inch longer than the other calls and produces better tonal qualities. It has proven superior to all other calls in actual field tests by championship callers.



CIRCE SQUEALER P-6 \$3.00



COON Model C-1 \$3.00

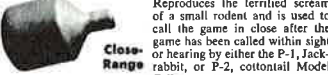

COAXER MODEL Model P-3 \$1.00

Reproduces the terrified scream of a small rodent and is used to call the game in close after the game has been called within sight or hearing by either the P-1, Jackrabbit, or P-2, cottontail Model Calls.

CIRCE VOICE KIT (pkg. of 4) - - - - \$2.00



## ELK CALL

\$5.50

The call that sounds exactly like the bull bugle call when in rutt. The flow of air blown into either end will determine the pitch and tone — no practice needed.



PETE  
RICKARD'S  
BUCK LURE  
\$2.00  
PER BOTTLE



## SCENT-VENT

6 per card \$1.50 each  
Forest Green

- Eliminates soiled hands and odor on clothing and person
- Use with your favorite deer or other animal scent
- Pin on clothes or place on tree or ground

• Opens to carry scent with the wind — closes air tight — store anywhere

## CAMOUFLAGE



### KAMO EQUIPMENT

#### VIET NAM PATTERN

2 pc. suit, S,M,L,XL - - \$12.95  
Jacket only - - - - - 7.00  
Pants only - - - - - 6.00  
Caps, each - - - - - 1.10  
Hunting Hat - - - - - 2.75  
2 piece bow cover - - - - - 1.75  
Kamo Paste Kit - - - - - 2.00  
Camouflage headnet - - - 1.50  
Kamo Tiger Stripe Suit - - 12.95



CAMOUFLAGE BUSH HAT \$5.00



CAMOUFLAGE TAPE  
\$1.00 per pkg.

## THOMAS GAME CALLS



REPLACEMENT VOICE - - - 75¢ each

**MARTIN CUSTOM BOWSTRING**

We make these from the finest material available - Type B Dacron and served with soft twisted Nylon

Made in bow lengths - - 44" to 72"

**STRANDS USED**

- Up to 25 lb. .... 8 strands
- 25 to 35 lb. .... 10 strands
- 35 to 45 lb. .... 12 strands
- 45 to 55 lb. .... 14 strands
- 55 to 65 lb. .... 16 strands

List \$1.50 each **PACKED IN NEW PLASTIC HANG-UP TUBE**

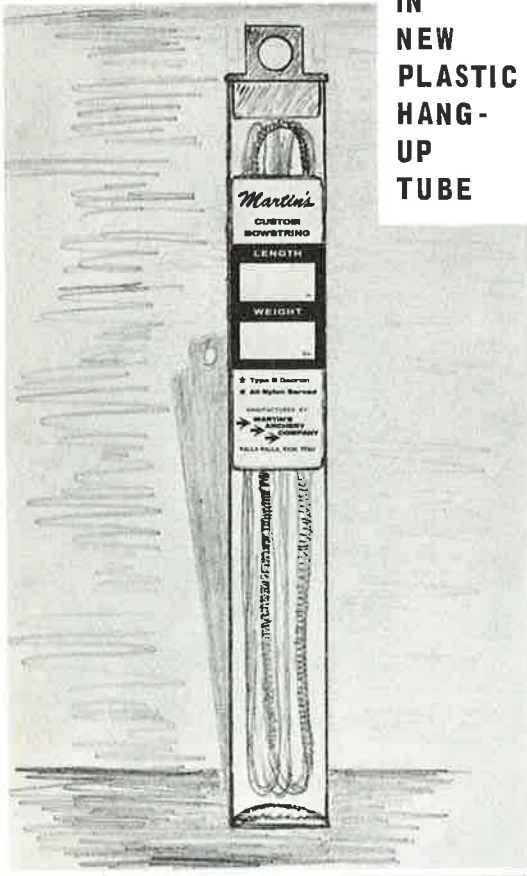

**MARTIN'S No. 305 Braided Double Loop Bowstring**

BRAIDED bowstring with center serving for bows to 40 lbs. Available for the following length bows: 48, 50, 52, 54, 56, 58, & 60". \$ .95

**MARTIN'S Single Loop Bowstring**

Made from 400 lb. Braided Dacron  
PACKED 12 ON DISPLAY CARD



To use single loop strings, make timber hitch knot as shown. Secure with tape or rubber band. \$ .50

**MARTIN STRING SERVER**

Server complete with nylon thread . . . . . \$1.80  
Colors: Red, Green, Yellow, Blue, White, and Black.



**Extra soft twist nylon SERVING THREAD**



- RED
  - GREEN
  - YELLOW
  - BLUE
  - WHITE
  - BLACK
- 100 yd. .75 ea.

Serving Jig Spool

MONOFILAMENT on Serving Spool .75 ea.

**TEX-TITE BOW STRING WAX**



60¢ Tube

**DACRON "B" BOWSTRING Fibre PRE-WAXED BONDED**



- 4 oz. spool White . . \$2.50
  - 4 oz. spool White Super "B" 43 . 3.00
  - 4 oz. spool Colors . . 3.00
- Thread Colors: Black, Yellow, and Green.
- 1 lb. spool White . . 9.50
  - 1 lb. spool Colors 10.50
- Colors: Black, Yellow, and Green

(QUANTITY PRICES AVAILABLE)

**MARTIN'S PRO Bowstring**

All black bowstring with monofilament center serving. . . . . \$2.00

Cross-Bow String. . . . . \$2.00

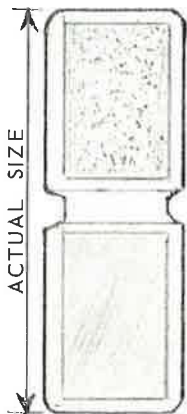

**MARTIN'S Velcro String Keeper** NEW

only \$ .75 ea.

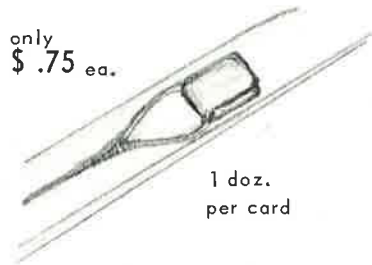

1 doz. per card

SELF-ADHESIVE



**New Blitzenburger Dial-O-Fletcher**

Fletches arrows diagonally, straight, or with true helical fletch right hand or helical fletch left hand. Precision die-cast, form-fitting, thumb-controlled clamps. Graduated scale on side of clamps accurately spaces feather or vanes from nock—120°, 75° x 105°, 90°, or 60°. New self-centering nock receiver fits all nocks. Knife edge on base of clamps eliminates surplus glue.

- Jig with straight clamp..... \$21.00
- With right or left hand true helical clamp. (Specify right or left clamp).. \$22.50
- Straight clamp only..... 4.50
- Helical clamp only (Specify R or L).... 6.00



**THOMPSON FLETCHING JIG**

Infinitely variable degree of right or left spiral can easily be set. Ideal for replacing one or two damaged feathers.

..... ea. \$18.75

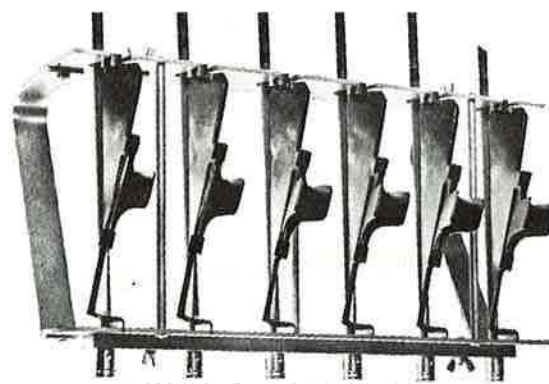

• 11° Helix For Each 1" of Feather •  
aluminum frame and plated steel clamps.

**"STRINGSMITH" BOW STRING JIG**



- Precision built tool of select material
  - Quick positive adjustment for all length bow strings
  - Careful and rugged construction
  - Metal fittings on end posts
  - Pivoting end posts automatically spread string for ease in serving
  - Designed for the professional or amateur
  - With excellent step by step illustrated instructions
- \$7.95



**EASTERN FLETCHER**  
Converts in seconds from 3 to 4 fletch of any angle desired. Mounts on bench at convenient angle.

#715 Fletcher \$6.95



**Fleetwood SPIRAL FLETCHER**  
Non adjustable spiral

- #5089 for L. W. feathers \$3.50
- #5088 for R. W. feathers \$3.50

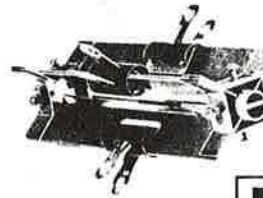

- SPIRAL 4 FEATHER FLETCHER**
- #5159 90° left spiral \$3.95
- #5083 90° right spiral \$3.95

**Fleetwood BURNERS**

Kit has all pieces loose. Easy to assemble.

#5166, \$2.95



**Young Feather Trimmer**  
\$22.50

Extra wire \$.25 ea.

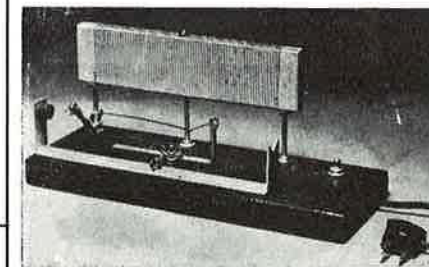

**EASTERN TRIMMER \$6.40**

Extra Wires for Eastern Trimmer Package of 3 . . . . . 30¢

**MULTI-FLETCHER**

FLETCHES 6 SHAFTS IN ONE JIG

**STRAIGHT**  
Right or Left Offset  
3 or 4 Feathers  
\$25.50

**HELICAL MULTI-FLETCHER**  
SPECIFY: LEFT OR RIGHT WING  
3 or 4 Feathers  
\$32.50

- Fletches any length feather up to 6".



**DIE CUT FEATHERS** Left Wing Only

	Shield	Parabolic	Shield	Shield
LENGTH . . . .	3"	3½"	4"	5"
White	3.40	3.80	4.30	5.50
Dyed White	3.40	3.80	4.30	5.50

(LIST PRICE PER HUNDRED)



**Martin's No. 1 Premium Feathers**  
Precision cut on our own machine

Specify Right or Left Wing

List per doz.

WHITE	\$1.00	DYED WHITE	\$1.10
-------	--------	------------	--------

See Price Sheet For Quantity Discount

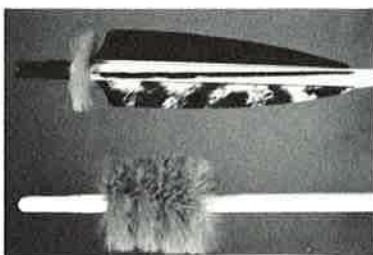

**FUR FLETCH**

- Use for fur fletch or tracer
- Quick simple installation

\$2.50 doz., 18.00 / C

DIP LACQUER qt. \$2.50  
colors custom mixed  
Lacquer THINNER qt. .75  
net price

**ARROW RECONDITIONING**

GLASS — WOOD OR METAL

REFLETCHED      RECRESTED  
RENOCKED        STRAIGHTENED

\$10.00 per doz.

4 Fletch . . . .  
\$2.00 extra per doz.

**FERR-L-TITE CEMENT**



Ferr-L-Tite stick .60  
Liquid type in tube .70



**FLETCH-TITE**  
60¢ each

**PAINT  
DIP TUBE**  
Special 2.98 ea.



- P 15 - (1 5/8") - - - - \$2.50 per 100
- P 22 - (2 2/8") - - - - 3.00 per 100
- P 23 - (2 3/8") - - - - 3.00 per 100
- P 25 - (2 5/8") - - - - 3.50 per 100
- P 26 - (2 6/8") - - - - 3.50 per 100
- P 32 - (3 2/8") - - - - 4.00 per 100

Flourescent orange, green and ruby,  
add \$1.00 per 100, each size.

Regular colors: Red, white, yellow,  
and black.

Extremely tough semi-pliable plastic  
Parabolic Sizes: P 23, P 26, & P 32



**DRI-TITE**  
60¢ bottle

**EVERFAST GLUE**

For fletching,  
nocks and  
general  
purpose . . . . .30 ea.



**PLIOBOND -**

A rubber base  
cement.

3 oz. bottle .79  
1 oz. bottle .39



**24SRT-X  
Fletching  
Cement**



For installing nocks,  
feathers or vanes on  
Easton Aluminum  
tubing. 1¼ oz. tube

. . . . . \$ .60 ea.

**EPOXY CEMENT KIT** . . . . . \$ .98

"All bows  
hand nocked"

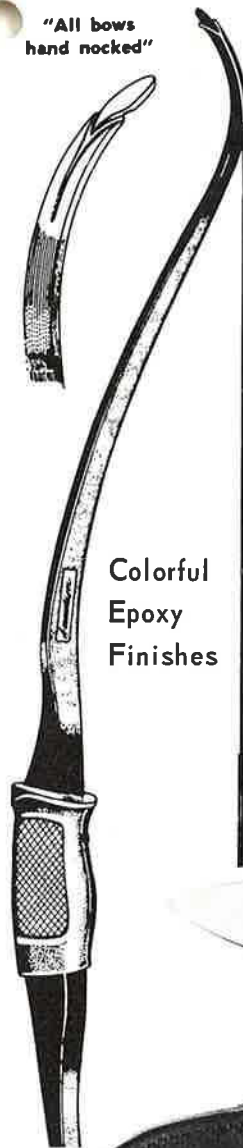

Colorful  
Epoxy  
Finishes

**FIBRE-GLASS BOWS**  
(Bow weights in 5 lb. increments)

42 in.	10 lb.	\$4.95
48 in.	20 - 25 lbs.	6.95
54 in.	20 - 35 lbs.	8.95
60 in.	40 - 55 lbs.	12.95

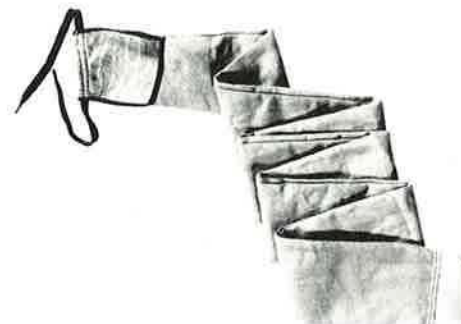

**#515 Canton Flannel BOWCASE**

6½ inches wide. Leather reinforced  
end flap and tie opening.  
Lengths: 62, 66, and 70 inches.  
Gold color only . . . . . \$3.50



**BOWCASES**

**STANDARD PADDED BOWCASE:**

No. 44 . . . . . \$10.95

Extra wide for full re-curve bow. Archer's  
waterproof cover lined with heavy tan napped  
flannel quilted to thick padding. 24" zipper  
opening, web zipper guard to protect bow from  
scratches. Lengths: 62", 66", 69". Width: 8½".

**Martin Flannel Bowcase**

Indicate Bow Length - - - - \$1.50  
See price sheet for qty. price.

*The Russell Belt Knife*

Russel Canadian Knife Model 1

- Flat back edge for easy slitting
- Unique 4-inch elliptical blade
- Handle gives knuckle clearance

PRICE \$14.00

Trout & Bird Knife Model 2

- Stainless, resists corrosion
- Women handle this knife easily

PRICE \$12.00

Russel Boat Knife Model 3

- Neat, comfortable to hold
- Self-hilt, good finger protection
- Wrist thong for extra holding

PRICE \$16.00

Russel Big Game Knife Model 4

- 5½ in. Swedish steel blade
- Ideal for trail blazing
- Heavy enough for light chopping

PRICE \$29.50

Russell BELT KNIVES are  
provided with original de-  
sign scabbards of hand-  
moulded, 6-ounce, top  
grain, stained and polished  
cowhide

**BLACKHAWK TAPERING SET**



- 2 main bodies: Nock taper  
— field or broadhead taper
- 4 bushings — 1/4", 9/32",  
5/16" and 11/32"
- Bushings have tapered  
sleeves to fit into tapered  
hole of main body
- Blades are regular Schick  
Injector Type
- Directions included \$3.95



**ACCURATE ARROW  
TAPER & TENON TOOL**  
\$1.50 ea.

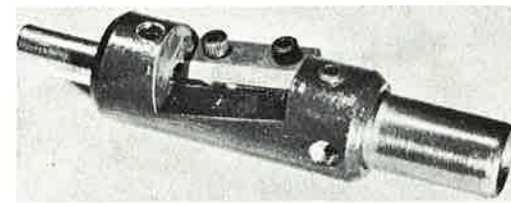

**EASTERN TAPERING TOOL**

The EASTERN TAPERING TOOL has a durable aluminum  
body. The hollow ground blade is of hardened tool steel.  
An adjustable steel stop and four steel interchangeable  
guide bushings for shaft sizes 9/32", 5/16", 11/32", and  
3/8" are included. All screws are Allen screws.

- ET-5 FOR 5° POINT TAPERS \$7.95
- ET-11 FOR 11½° NOCK TAPERS \$7.95
- EXTRA BLADE—FOR ET-5 OR ET-11 \$1.00

CLASS \_\_\_\_\_ TOTAL \_\_\_\_\_

NAME \_\_\_\_\_

CLUB \_\_\_\_\_ DATE \_\_\_\_\_

HITS	X	SCORE	HITS	X	SCORE
1			15		
2			16		
3			17		
4			18		
5			19		
6			20		
7			21		
8			22		
9			23		
10			24		
11			25		
12			26		
13			27		
14			28		
TOTAL 1st 14			TOTAL 2nd 14		
1st 14			1st 14		
GRAND TOTAL					

Field Score Cards  
\$8.75/M

**MICRO-FLITE**  
SHAFT SIZE  
SELECTION CHART

TARGET ARROWS

Bow Weight at Draw Length	Draw Length									
	23"	24"	25"	26"	27"	28"	29"	30"	31"	
20-25	0	0	0	1	2	3	4	5	6	
25-30	0	0	1	2	3	4	5	6	7	
30-35	0	1	2	3	4	5	6	7	8	
35-40	1	2	3	4	5	6	7	8	9	
40-45	1	2	3	4	6	7	8	9	10	
45-50	2	3	4	5	6	7	8	9	10	
50-55		4	5	6	7	8	9	10	11	
55-60		5	6	7	8	9	10	11	11	
60-65			7	8	9	10	11	11	12	
65-70			8	9	10	10	11	12	12	
70-75				10	10	11	12	12	12	

HUNTING AND FIELD ARROWS

Bow Weight at Draw Length	Draw Length									
	23"	24"	25"	26"	27"	28"	29"	30"	31"	
30-35	1	2	3	4	5	6	7	8	9	
35-40	2	2	3	4	5	6	7	8	9	
40-45		3	4	5	6	7	8	9	10	
45-50		4	5	6	7	8	9	10	11	
50-55		5	6	7	8	9	10	11	11	
55-60			7	8	9	10	11	11	12	
60-65			8	9	10	11	11	12	12	
65-70			9	10	11	11	12	12	12	
70-75				10	11	12	12	12	12	
75-80					11	11	12	12	12	
80-85						11	12	12	12	
85-90							12	12	12	

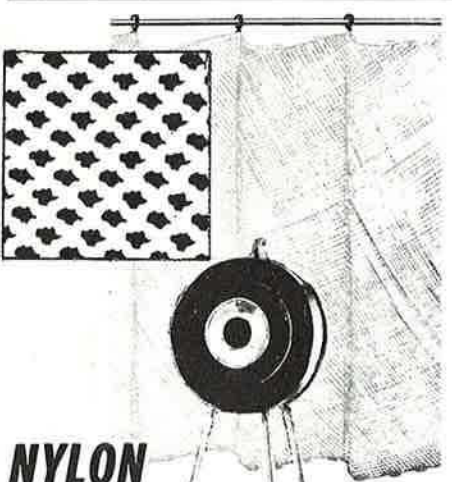

**NYLON BACKSTOP NET**

This all nylon woven net will stop an arrow from any weight bow without injury to either the arrow or the net. Perfect as a backstop for archery range, school, store, club or wherever archery is shot. Use pole or rope to hang and drape on floor. The rings are included. 8' high by any length long.

8' high. Running ft. 4.00

**EASTON SHAFT SIZE SELECTION CHART**

These charts will give the shaft size that will shoot well for the majority of archers with a minimum of additional bow tuning.

ACTUAL BOW WT.	ARROW LENGTH (See Step 4, page 2)										SHAFT WEIGHT (per inch)
	22	23	24	25	26	27	28	29	30		
15-20#	22	23	24	25	26	27	28	29	30		EX. LIGHT (.013)
	1416	1416	1416	1416	1516	1616	1616				LIGHT (.016)
20-25#					1713	1713	1813	1813			EX. LIGHT (.013)
	1416	1416	1470	1510		1616		1716			LIGHT (.016)
25-30#						1713	1713	1813	1813	1913	EX. LIGHT (.013)
	1416	1416	1510		1616		1716	1816			LIGHT (.016)
30-35#					1713	1713	1813	1813	1913	2013	EX. LIGHT (.013)
			1510		1616		1716	1816	1816	1916	LIGHT (.016)
					1918	1918	1818	1818			MEDIUM (.018)

ACTUAL BOW WT.	ARROW LENGTH (See Step 4, page 2)										SHAFT WEIGHT (per inch)
	23	24	25	26	27	28	29	30	31	32	
35-40#	23	24	25	26	27	28	29	30	31	32	EX. LIGHT (.013)
	1713	1813	1813	1913	2013	2013	2114	2213	2213		LIGHT (.016)
40-45#	1816	1716	1816	1816	1916	1916	2016	2016			LIGHT (.016)
	1616	1718		1818	1818	1918	2018				MEDIUM (.018)
45-50#	1813	1913	2013	2013	2114	2213	2213				EX. LIGHT (.013)
	1716	1816	1816	1916	1916	2016	2016				LIGHT (.016)
50-55#	1718		1818	1818	1918	2018	2018				MEDIUM (.018)
			1820	1820	1920	2020	2020	2219	2219		HEAVY (.020)

**HUNTING Broadhead Shaft Size and Finished Arrow Weight\***

ACTUAL BOW WEIGHT	SHAFT SIZE	BROADHEAD ARROW LENGTH					
		27	28	29	30	31	32
45	SHAFT WEIGHT IN GRAINS	444	476	466	523	535	588
	SHAFT WEIGHT IN GRAINS	1918	2016	2018	2018	2020	2219
50	SHAFT WEIGHT IN GRAINS	468	456	511	523	575	598
	SHAFT WEIGHT IN GRAINS	1918	2016	2018	2020	2219	2219
55	SHAFT WEIGHT IN GRAINS	468	456	511	562	584	596
	SHAFT WEIGHT IN GRAINS	2018	2018	2020	2219	2219	2219
60	SHAFT WEIGHT IN GRAINS	487	499	549	570	584	598
	SHAFT WEIGHT IN GRAINS	2018	2020	2219	2219	2219	
65	SHAFT WEIGHT IN GRAINS	487	536	557	570	584	
	SHAFT WEIGHT IN GRAINS	2020	2020	2219	2219		
70-80	SHAFT WEIGHT IN GRAINS	523	536	557	570		
	SHAFT WEIGHT IN GRAINS						

\*Weight includes: shaft, 125 grain broadhead point and fletching.

**EASTON X7 SHAFT SIZE SELECTION CHART**

BOW WEIGHT	ARROW LENGTH (INCHES)									
	24	25	26	27	28	29	30	31	32	
20-25			1614	1616	1714	1716	1814			
25-30			1614	1616	1714	1716	1814	1816	1914	
30-35			1614	1616	1714	1716	1814	1816	1914	2014
35-40			1616	1714	1716	1814	1816	1914	1916	2014
40-45			1716	1814	1816	1914	1916	2014	2014	
45-50					1914	1916	2014	2014		

X7 is available in 1614, 1714, 1814, 1914, and 2014 only.

INDOOR PAA  
FACES BLUE  
with  
WHITE BULLSEYES

New blue and white  
20" face  
on heavy tag.

22¢ ea.

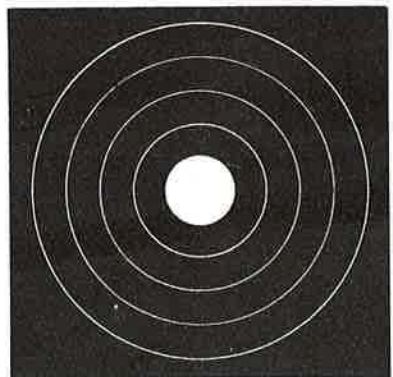

**RAW MATERIALS**

Points - Target 5/16 or 11/32 tapered ..... per doz. 1.00  
Points - Target 5/16 or 11/32 tapered ..... per C 7.00  
Points - Field 5/16 or 11/32 parallel or 5° taper hole .... per doz. 1.00  
Points - Field 5/16 or 11/32 parallel or 5° taper hole .... per C 7.00

Drawn Steel Points 5/16 ..... per C 2.00  
Drawn Steel Points 11/32 ..... per C 2.50

Easton Swift shafts Full length, Points loose ..... per doz. 16.60  
Easton shafts 24SRT-X Full length, Points loose ..... per doz. 20.80  
Easton shafts 24SRT-X Cut to length, Points installed ..... per doz. 22.00  
Easton shafts XX75 Full length, Points loose ..... per doz. 25.80  
Easton shafts XX75 Cut to length, Points installed ..... per doz. 27.00  
Easton shafts X7 Full length, Points loose ..... per doz. 30.80  
Easton shafts X7 Cut to length, Points installed ..... per doz. 32.00

Extra Broadhead Adaptors for Easton Shafts ..... per doz. 2.40  
Extra Target Points for Easton Shafts ..... per doz. 3.80

Micro-flite shafts Full length, Nock and points loose ..... per doz. 17.50  
Micro-flite shafts Cut to length, Nock & points installed ..... per doz. 19.50

Compressed Wood Battleshaft Shafts ..... per doz. 9.95

Port Orford Cedar Shafts - Matched within 5# spine  
No. 1 - 11/32 or 5/16 Matched in weight and spine ..... per doz. 3.00  
No. 1 - 11/32 or 5/16 Matched in weight and spine ..... per C 17.50  
PREMIUM Port Orford Cedar Shafts ..... (Net Price) ..... per M 75.00  
No. 2 Select Port Orford Cedar Shafts ..... (Net Price) ..... per M 52.50  
Mill Run Port Orford Cedar Shafts ..... (Net Price) ..... per M 52.50  
Utility Grade Port Orford Cedar Shafts ..... (Net Price) ..... per M 37.50

Shaft Painting Dip Lacquered in your choice of color ..... per doz. 3.50

Nocks - 1/4, 9/32, 5/16, 11/32 in. .... per doz. .45  
Nocks - 1/4, 9/32, 5/16, 11/32 in. .... per C 2.00  
(See Price Sheet for Quantity Discount)

Mid Nox 1/4 or 9/32, White or Flame Orange ..... per doz. 1.20  
Mid Nox 1/4 or 9/32, White or Flame Orange ..... per C 9.50

Solid Glass Fish Shafts 5/16 x 30 in. .... each 1.00  
Solid Glass Fish Shafts 5/16 x 30 in. .... per doz. 10.00

Rubber Vanes ..... each .30  
Rubber Vanes ..... per doz. 3.35



**THE "SNAPPY" BJORN NOCK**

- SMOOTH - STRONG - SNAPPY -

Sizes: 1/4" - 9/32" - 5/16"

- BETTER PRECISION—arrows get identical acceleration—the string can never roll out as on a conventional nock
- FLATTER TRAJECTORY—due to the .006 "snap" action
- SMOOTH DESIGN—finger surfaces widened and smoothly rounded—a good aid to the nock "feelers"

White-Black ..... \$1.00 dz. — \$7.50/100  
Transparent red — Trans. blue — Fluor. rose — Fluor. lgt. green ..... \$1.10 dz. — \$8.30/100



**MID NOX**

\$1.20 doz.  
9.50 hundred

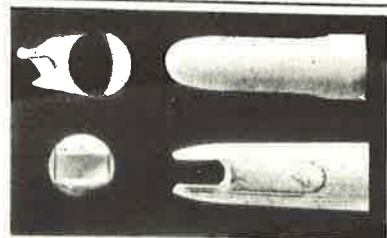

**TRU-NOCK**

Per DOZEN \$.75  
Per HUNDRED \$3.00  
Per THOUSAND \$25.00

**FLOURESCENT COLORS**  
RED, GREEN, WHITE

No sharp corners to cut string.  
Shaped to reduce finger pinch.  
Feather edged end.  
Sizes--1/4, 9/32, & 5/16

**... NEW**

**MARTIN'S BULK FLETCHING CEMENT**

- Crystal Clear
- Fast Drying
- Super Strength

For Wood,  
Glass or Al.

WGA-66

\$2.50 pt. net

2 oz.  
DISPENSER  
for bulk glue  
20¢ ea. net



No. HME-1  
for 24" and 30"  
matts. \$5.95

No. HME-2  
Adjustable easel  
for 36" and 48"  
matts. \$11.95

GUARANTEED TO OUTLAST 3 TO 1

# SAUNDERS MATTS

Choice of Tournament Officials at 45 of the last 46 major meets



REGULATION MATTS	OUTDOOR	Plain	Burlap Covered
48 in., 70 lbs. No. 48	- \$34.50	No. 48B	- \$34.50
Exclusive End-Grain Centers	36 in., 40 lbs. No. 36	- 19.90	No. 36B - 19.90
	30 in., 30 lbs. No. 30	- 14.95	No. 30B - 14.95
	24 in., 20 lbs. No. 24	- 11.95	No. 24B - 11.95
	16 in., 10 lbs. No. 16	- 5.95	No. 16B - 5.95

Heavy Tag  
OFFICIAL PAA



INDOOR ROUND  
16", .15



OFFICIAL HUNTER'S ANIMAL  
14 Target Set \$5.95



ROVING ROUND FACES  
14 Target Set  
\$3.40

OFFICIAL NFAA  
FIELD FACES



HEAVY TAG

OFFICIAL BLACK  
HUNTER'S  
ROUND FACES



14 Target Set  
\$4.95

24 in., No. B24	\$ .25	Set of 36 Faces
18 in., No. B18	.15	No. B36
12 in., No. B12	.10	\$3.40
8 in., No. B8	.07	
6 in., No. B6	.04	

STANDARD 4-COLOR FACES

All 48" are official.

SQUARE (Heavy Tag)	
48 in., No. P48	- \$1.69
36 in., No. P36	- .95
24 in., No. P24	- .50
16 in., No. P16	- .20

Lightweight Stock	
16 in., No. LW16	.13

INTERNATIONAL

(FITA) Faces	
120 CM	\$2.98
80 CM	1.00

SKIRTED 4-COLOR (Toughenized)

48 in., No. TS48	- \$4.50	No. 480C	- \$6.50
36 in., No. TS36	- 3.50	No. 360C	- 5.00
24 in., No. TS24	- 1.89	No. 240C	- 3.50
16 in., No. TS16	- .95		



Most life-like full-color animal faces made!



24 in. Deer or Mountain Lion	CA24	.50
18 in. Fox or Wild Turkey . . . .	CA18	.30
12 in. Pheasant or Bobcat . . .	CA12	.20
6 in. Squirrel or Bluejay . . . .	CA6	.07
36 Faces in Set . . . . .	CA36	6.50

So natural they'll give you "buck fever!"

FULL NATURAL COLOR ON TAG STOCK