



**PARIS TEXAS  
HARDWARE**

August 2021

Retail Price List and  
Product Information Guide

## Contents

### General Information

- Production Time
- Returns
- Shipping
- Materials
- Dimension Key
- Finishes
- PTH Perfect Match™

|                              |    |
|------------------------------|----|
| Portfolio .....              | 1  |
| Portfolio 1" .....           | 1  |
| 1" Hand Drawn Traverse ..... | 11 |
| Portfolio 1¼" .....          | 14 |
| Portfolio 1⅜" .....          | 21 |
| Portfolio 2 .....            | 25 |
| Portfolio 2¼" .....          | 28 |
| Portfolio Holdbacks .....    | 32 |

### Corded and Motorized Traverse ..... 35

- Corded Traverse ..... 36
  - Heavy-Duty Ball Bearing System ..... 36
- Motorized Traverse ..... 40
  - BTX DC Motorized System
  - Somfy Glydea™ Motorized System

### Quick Ship ..... 49

- Quick Ship Metal 1" ..... 49
  - 1" Hand Drawn Traverse System ..... 54
- Quick Ship Wood and Resin 1⅜" ..... 57
- Quick Ship Wood and Resin 2¼" ..... 61

### Order Forms

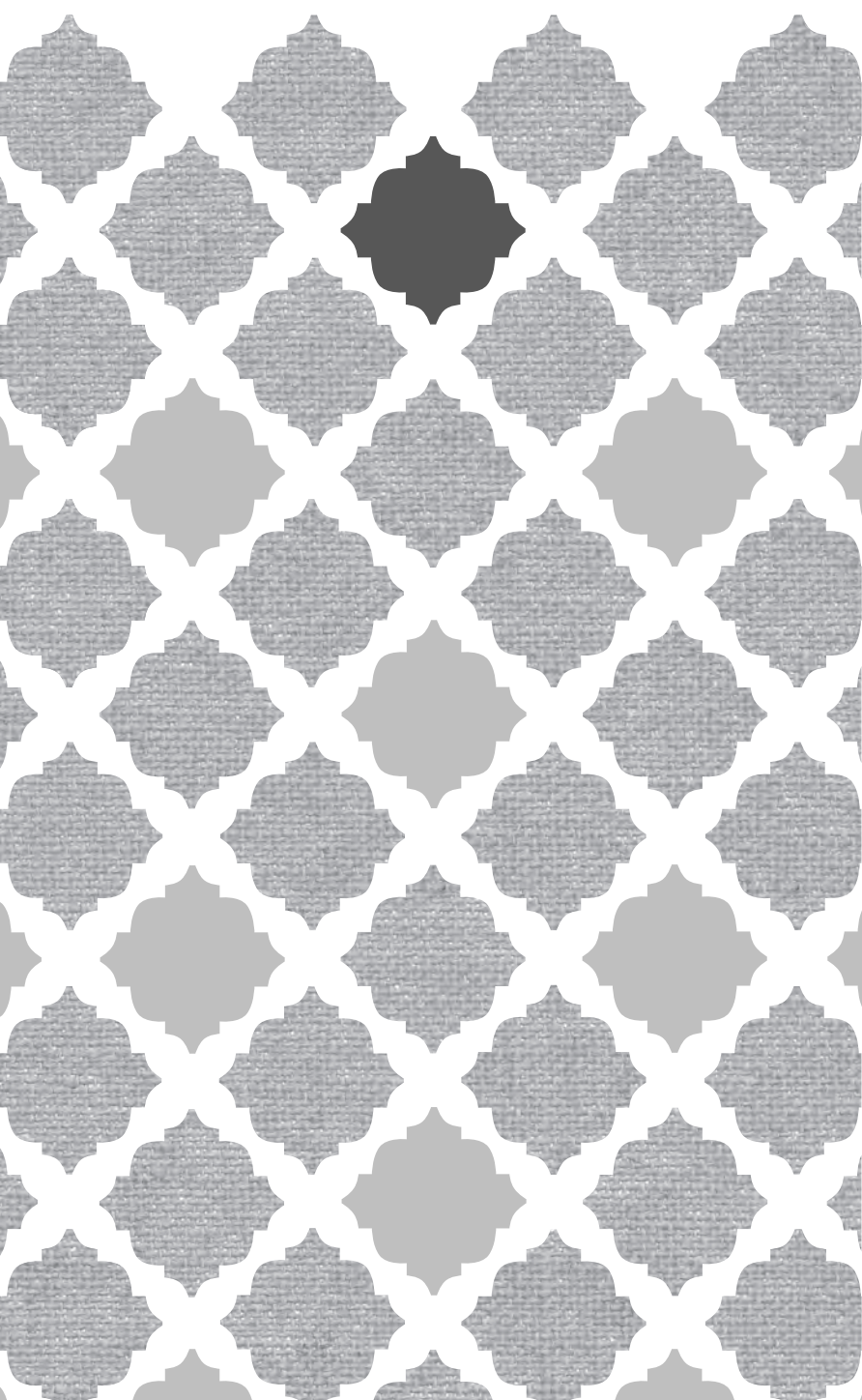

# General Information

## Production Time

Purchase orders are processed once they are received by Paris Texas Hardware. Incomplete information will delay processing and shipping. Quick Ship collections are in stock and ship within 24 hours. Quick Ship orders received before noon CST ship the same day. Portfolio custom collection is hand finished and ships within 10-15 business days.

## Corded and Motorized Traverse Systems

Traverse systems are available for Portfolio and Quick Ship Wood and Resin 2 ¼". Production time for traverse system orders is 10-15 business days.

## Pricing and Terms

Pricing found in the Paris Texas Hardware Price List are our Suggested Retail Prices. Due to the U.S. government's current policy on China tariffs, all products are subject to a tariff surcharge as of September 1st, 2019. Prices are subject to change without notice. Prices are quoted exclusive of Freight and Packaging. The Buyer should always inspect the product upon receipt. **IMPORTANT:** Please note that your order will be placed with an authorized Paris Texas Hardware Distributor. While most of the following will generally apply, your distributor may have terms and conditions of the sale that will vary from what is stated here.

## Returns, Changes, and Cancellations

All Portfolio and PTH Perfect Match™ products are custom painted and may not be returned. Orders may not be changed or cancelled once production has begun.

Quick Ship items may be returned if poles are uncut and all products are received in sellable condition. A restocking fee of 40% will apply and the customer will prepay freight. All returns must be authorized by the Paris Texas Hardware customer service department, and are authorized at our discretion, given the circumstances and nature of each order. A Return Authorization Number (RA#) must be issued by customer service, and the RA# must be noted on all return packages. Return Credit is issued on returned goods that are inspected and deemed undamaged. Customers should exercise care to adequately package return goods. Return Credit will not be issued for unauthorized returns or damaged returns.

## Shipping

All orders are shipped FOB Dallas, Texas. Standard size orders ship using normal guidelines via UPS or FedEx ground. Average transit time is three to seven business days. Three Day Select, Second-Day or Next-Day Air services may be requested. Poles over 100" MUST be shipped by common carrier and incur a net freight fee of \$110. Shipments exceeding these limits will require a special freight quote. Additional charges incurred such as residential delivery fees, incorrect address and beyond destination fees may be invoiced separately. Expedited shipments are not available in all areas. Any additional charges for expedited shipments will be in addition to the net \$110 freight fee.

The following orders are subject to actual freight costs:

- shipments going to Alaska, Hawaii, Idaho, Montana, Puerto Rico or any International destinations
- orders with poles or tracks exceeding 16'
- orders that exceed a SRP of \$2,500

## Packaging Fees (Net Fees):

A net packaging fee of \$10 per order will apply to any order that has a pole. The net packaging fee increases to \$25 for all orders with mitered fascia returns, motorized track, or poles and corded traverse track 16 feet or longer.

## Damaged Goods and Freight Claims

Immediately upon receipt, your order should be inspected to ensure that there is no concealed damage from shipping. To report a claim, contact your Paris Texas Hardware distributor. Damage and freight claims must be made within 15 days of receipt of goods. Claims reported after 15 days will not be accepted. To expedite the claim process, please provide your distributor with the following information: purchase order number, Paris Texas Hardware order number, shipping phone number and address, and a complete list of damaged items. Freight companies require all packaging materials and damaged items to be kept for inspection. Merchandise damaged in shipping will be replaced. Our policy is that we replace damaged product per the original order.

Please note on the Bill of Lading if there is any possibility of concealed damage.

## Installation

We recommend using a professional installer. Installation hardware is included. The fasteners (screws and mollies) may not be appropriate for every installation or wall material. Brackets and holdbacks should be installed securely into wall studs when possible. Paris Texas Hardware will not assume responsibility for damages incurred by improperly mounted or inadequately supported hardware.

## Materials

Some finials, brackets, holdbacks, and rings are made of resin composite materials. Resin may be damaged by cutting, drilling, or attempting to alter the size or shape of products. Some items are made of cast aluminum or stamped steel. Wood poles and wood rings are made of various hardwoods. Metal poles and metal rings are made of steel.

## Poles

Poles may be spliced together using a dowel splicing screw, which is included with each pole. We recommend a center support bracket for pole lengths in excess of four feet. We cannot guarantee against sagging caused by unsupported spans greater than our recommended four feet.

## Finials and Holdbacks

**All finials and holdbacks are sold as pairs.** Most resin finial bases have a 1/8" recess for a clean pole fit. Resin finials are fitted with a dowel screw that may not be removed without damaging the finial.

## Brackets

**Brackets are sold individually.** Depending on the style of the bracket, there are three wall mounting styles: key lock, round mounting plate, or front drill. Some heavier treatments may require stronger fasteners (mollies and screws) than those included with the brackets. Brackets should be installed securely into wall studs. We recommend support brackets every 3-4 feet.

# General Information

## Rings

**Rings are sold individually.** Eyelets are not detachable from resin rings. Excessive movement of rings on the top of the pole will naturally abrade the finish. We discourage using heavy treatments with the 1" resin rings. We recommend three to four rings per foot of finished pole length, or six to seven rings per width of fabric.

## Dimension Key

### Finials

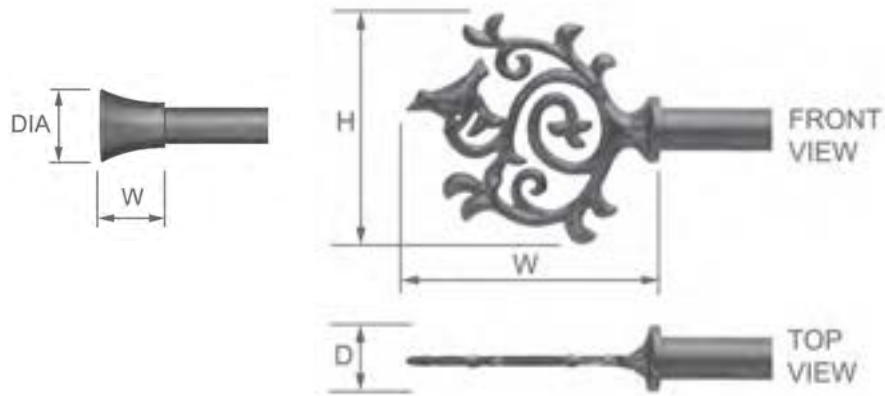

### Holdbacks

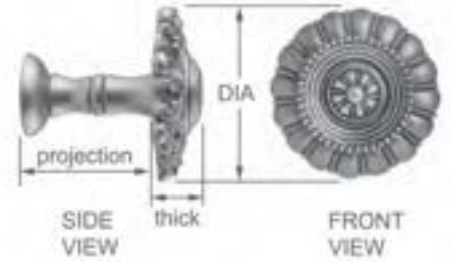

### Rings

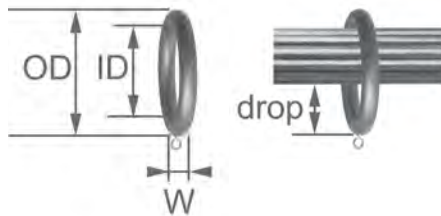

### Poles



### Elbows

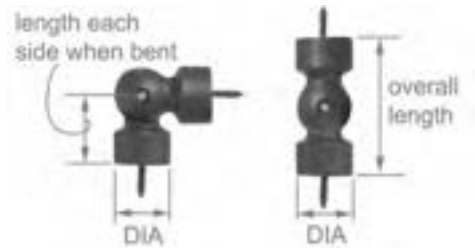

### Wall Mount Brackets

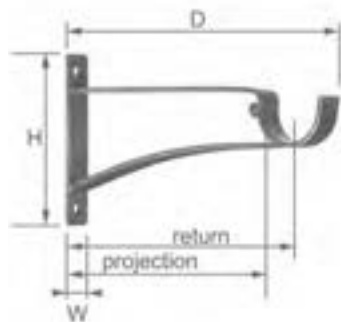

### Ceiling Mount Brackets



### Inside Mount Brackets

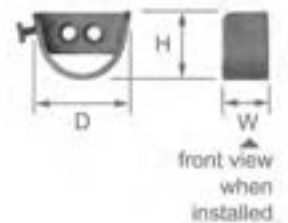

## General Information

| PORTFOLIO FINISHES          |                        |
|-----------------------------|------------------------|
| AM                          | Amulet                 |
| AND                         | Andiron                |
| AG                          | Antique Gold           |
| AGL                         | Antique Gold Leaf      |
| AB                          | Art Bronze             |
| BW                          | Barnwood               |
| BL                          | Black                  |
| CIN                         | Cinnamon               |
| DC                          | Dark Chocolate         |
| ET                          | Eternal                |
| FL                          | Firelight              |
| GR                          | Goldenrod              |
| GOS                         | Gossamer               |
| HA                          | Halo                   |
| JA                          | Java                   |
| LIN                         | Linen                  |
| MK                          | Mink                   |
| ML                          | Moonlight              |
| MYS                         | Mystic                 |
| NAB                         | New Age Bronze         |
| PAR                         | Parchment              |
| SH                          | Shimmer                |
| SM                          | Silver Maple           |
| SPW                         | Spicewood              |
| SPG                         | Spun Gold              |
| ST                          | Starlet                |
| TIM                         | Timber                 |
| TTM                         | Titanium               |
| URB                         | Urban Bronze           |
| WH                          | White                  |
| PTH PERFECT MATCH™ FINISHES |                        |
| PPMEF                       | Eggshell Sheen Level   |
| PPMHGF                      | High-Gloss Sheen Level |
| PPMGLITTER                  | Glitter Highlights     |
| PPMGOLD                     | Gold Highlights        |
| PPMROSEGOLD                 | Rose Gold Highlights   |
| PPMSILVER                   | Silver Highlights      |
| QUICK SHIP FINISHES         |                        |
| 1" METAL                    |                        |
| QSAB                        | Antique Brass          |
| QSBN                        | Brushed Nickel         |
| QSMID                       | Midnight               |
| QSORB                       | Oil Rubbed Bronze      |
| QSRG                        | Rose Gold              |
| LUXE LINE                   |                        |
| QSLXAB                      | Antique Brass          |
| QSLXBN                      | Brushed Nickel         |
| QSLXBK                      | Black                  |
| WOOD AND RESIN 1½" and 2¼"  |                        |
| QSAB                        | Antique Brass          |
| QSORB                       | Oil Rubbed Bronze      |
| QSPL                        | Platinum               |
| QSRG                        | Rose Gold              |
| QSWAL                       | Walnut                 |

### Finishes

Finishes with antiquing, dusting, or glazing will vary from product to product depending on the level of detail. Areas with deeper recesses will appear darker than smooth areas.

For the best possible finish match, refer to the 2014 Paris Texas Hardware Finish Chips. These chips have smooth, fluted, and carved detailed areas, enabling you to see the beautiful shadings and highlights that make our finishes so special.

#### Portfolio

**Portfolio Strike-offs:** For a fee of \$50 (net) per finish / strike-off, Paris Texas Hardware will provide a sample of your Portfolio finish on any 6" wood or metal pole as requested. Customer approval of the strike-off sample is required before production will begin.

**Portfolio Touch up paint:** For a fee of \$20 per vial, touch-up paint can be sent to the customer on request.

#### PTH Perfect Match™

On your purchase order, specify the following:

- Benjamin Moore® color name and number
- sheen level: high-gloss or eggshell
- highlight color, if desired (silver, gold, rose gold, or glitter)

Each color specified (every time we purchase paint) will be subject to a separate minimum. If you have different colors for different rooms of hardware, please put them on separate purchase orders. Purchase includes 1 oz of touch-up paint. If there is enough of your Benjamin Moore® paint leftover, we'll keep it for 30 days. After 30 days, we'll dispose of it using an environmentally responsible paint service.

#### Single Color - No Highlight:

10% upcharge or \$100 minimum (net)

**Strike-off available:** For a fee of \$50 (net) per color, a sample of your Benjamin Moore® paint will be provided on a PTH sample chip. When you place your order, we will credit \$25 of this fee toward your order with that paint color.







#### Single Color - With Highlight:



15% upcharge or \$150 minimum (net)

**Strike-off available:** For a fee of \$60 (net) per color with highlight, a sample of your Benjamin Moore® paint with highlight will be provided on a PTH sample chip. When you place your order, we will credit \$30 of this fee toward your order with that paint color.

Order must be received within 30 days or strike-off paint will be disposed and no credit will be issued. In lieu of purchasing strike-offs, we encourage you to use your Benjamin Moore® paint deck for color reference.

1" Modern Metal Finials fit the 1" metal pole, but DO NOT fit the 1" Hand Drawn Traverse System.

|   |  |   |  |  |   |
|---|--|---|--|--|---|
|  <p>PO100COFI<br/>Cole<br/>3¼" (8.3 cm) W<br/>1½" (3.8 cm) DIA<br/>\$93.50 pair*</p> |  <p>PO100ELAFI<br/>Ella<br/>1½" (3.8 cm) W<br/>1⅝" (4.1 cm) DIA<br/>\$71.50 pair*</p> |  <p>PO100EMFI<br/>Elm<br/>1½" (2.9 cm) W<br/>2" (5.1 cm) DIA<br/>\$71.50 pair*</p> |  <p>PO100EMFIGL<br/>Elm - Smoke Glass<br/>1½" (2.9 cm) W<br/>2" (5.1 cm) DIA<br/>\$104.50 pair*</p> |  <p>PO100KNFI<br/>Knox - Crystal<br/>1¼" (3.2 cm) W<br/>2¼" (5.7 cm) DIA<br/>\$137.50 pair*</p> |  <p>PO100LXFI<br/>Lex<br/>1¾" (4.4 cm) W<br/>2" (5.1 cm) DIA<br/>\$60.50 pair*</p> |
|---|--|---|--|--|---|

|   |   |   |
|---|---|---|
|  <p>PO100LUEC<br/>Luna End Cap<br/>¾" (1.9 cm) W<br/>1¼" (3.2 cm) DIA<br/>\$38.50 pair*</p> <p><i>Luna End Cap covers ⅝" (1.6 cm) of end of pole; finished pole length may need to be increased accordingly.</i></p> |  <p>PO100NOFI<br/>Nora<br/>2" (5.1 cm) W<br/>2¼" (5.7 cm) DIA<br/>\$104.50 pair*</p> |  <p>PO100NOFIGL<br/>Nora - Mercury Glass<br/>2⅝" (5.4 cm) W<br/>2⅜" (6.0 cm) DIA<br/>\$137.50 pair*</p> |
|---|---|---|

1" Modern Metal Finial Accessories:

|  |  |
|--|--|
|  <p>PO100BRBAND<br/>1" Braided Band<br/>⅝" (1.6 cm) W<br/>1¼" (2.7 cm) ID<br/>1⅝" (4.1 cm) OD</p> <ul style="list-style-type: none"> <li>resin; available in any Portfolio Finish</li> <li>not recommended for 1" Hand Drawn Traverse System</li> </ul> <p>\$38.50 ea</p> |  <p>PO100CRMEBAND<br/>1" Crystal Band<br/>⅝" (1.6 cm) W<br/>1¼" (2.7 cm) ID<br/>1⅝" (4.1 cm) OD</p> <ul style="list-style-type: none"> <li>metal; available only in dark metal with inlaid crystals</li> <li>not recommended for 1" Hand Drawn Traverse System</li> </ul> <p>\$33.00 ea</p> |
| <ul style="list-style-type: none"> <li>1" Bands cover ⅝" of pole</li> <li>only for use with 1" pole</li> </ul>   |  |

Install 1" Bands anywhere along the length of your pole... spread them out or stack them side by side for a dramatic effect.

These 1" Bands can be used on a 1" pole in 2 ways:

- against the base of a 1" finial for a touch of glamour
- anywhere on the 1" pole for additional decoration

How To Add Your Band:



Before installing your 1" Modern Metal Finials, simply slide each Band into position on your 1" pole.











Install finials. Secure each Band by tightening set screw.

\*Sold in pairs only.

**1" Transitional Metal Finials** fit the 1" metal pole and the 1" Hand Drawn Traverse System.

Note: Each Transitional Metal Finial covers  $\frac{5}{8}$ " (1.6 cm) of pole or track; finished pole length may need to be increased accordingly.

|  |  |   |  |   |   |
|--|--|---|--|---|---|
|          |         |      |                       |                |    |
| PO100COFICU<br>Cole with 1" Cuff<br>4" (10.2 cm) W<br>1½" (3.8 cm) DIA<br>\$121.00 pair* | PO100ELAFICU<br>Ella with 1" Cuff<br>2¼" (5.7 cm) W<br>1⅝" (4.1 cm) DIA<br>\$99.00 pair* | PO100EMFICU<br>Elm with 1" Cuff<br>1⅞" (4.8 cm) W<br>2" (5.1 cm) DIA<br>\$99.00 pair* | PO100EMFIGLCU<br>Elm - Smoke Glass with 1" Cuff<br>1⅞" (4.8 cm) W<br>2" (5.1 cm) DIA<br>\$132.00 pair* | PO100KNFICU<br>Knox - Crystal with 1" Cuff<br>2" (5.1 cm) W<br>2¼" (5.7 cm) DIA<br>\$165.00 pair* | PO100LXFICU<br>Lex with 1" Cuff<br>2½" (6.4 cm) W<br>2" (5.1 cm) DIA<br>\$88.00 pair* |

|   |  |  |
|---|--|--|
|  |         |                           |
| PO100LUEC<br>Luna End Cap<br>¾" (1.9 cm) W<br>1¼" (3.2 cm) DIA<br>\$38.50 pair*   | PO100NOFICU<br>Nora with 1" Cuff<br>2¾" (7.0 cm) W<br>2¼" (5.7 cm) DIA<br>\$132.00 pair* | PO100NOFIGLCU<br>Nora - Mercury Glass with 1" Cuff<br>2⅞" (7.3 cm) W<br>2⅝" (6.0 cm) DIA<br>\$165.00 pair* |

**1" Transitional Metal Finial Accessory:**



**POTRADCO**  
Traditional Collar  
⅝" (1.6 cm) W  
1⅞" (2.9 cm) DIA

- metal; available in any Portfolio finish
- must be used with the 1" Cuff
- installs between the Finial and 1" Cuff
- Adding Traditional Collar increases width of finial by  $\frac{5}{8}$ " (1.6cm)

\$33.00 pair\*

Add this turned element to your finial for a Traditional look.

(Finial maintains compatibility with the 1" Hand Drawn Traverse System.)

**How To Make It Traditional:**

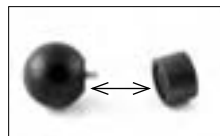

Unscrew the Transitional Finial from its Cuff.

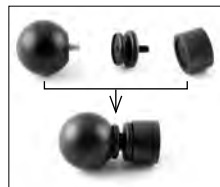







Screw Finial into the Traditional Collar. Screw Traditional Collar into the Cuff.





- Brushed Nickel Collar may be found on page 58.

\*Sold in pairs only.

**1" Textured Metal Finials** fit the 1" pole, but DO NOT fit the 1" hand drawn traverse system.







Note: 1" Cuff can be purchased separately and attached to any 1" Textured Metal Finial to make it compatible with the 1" Hand Drawn Traverse System.

|   |   |  |  |  |  |
|---|---|--|--|--|--|
|  <p>PO100ACFI<br/>Achilles<br/>4¼" (10.8 cm) W<br/>1¾" (4.4 cm) DIA<br/>\$104.50 pair*</p> |  <p>PO100CSFI<br/>Cassia<br/>4½" (11.4 cm) W<br/>2¾" (6.0 cm) DIA<br/>\$104.50 pair*</p> |  <p>PO100DMFI<br/>Demetrius<br/>3" (7.6 cm) W<br/>2¾" (6.0 cm) DIA<br/>\$104.50 pair*</p> |  <p>PO100GPI<br/>Grapefern<br/>5" (12.7 cm) W<br/>3¾" (9.5 cm) DIA<br/>\$93.50 pair*</p> |  <p>PO100HEFI<br/>Hector<br/>5¾" (14.9 cm) W<br/>5¾" (13.7 cm) H<br/>1½" (3.8 cm) DIA<br/>\$93.50 pair*</p> |  <p>PO100LRFI<br/>Larkspur<br/>6¾" (16.2 cm) W<br/>5½" (13.0 cm) H<br/>1½" (3.8 cm) DIA<br/>\$93.50 pair*</p> |
|---|---|--|--|--|--|

|  |   |  |   |  |
|--|---|--|---|--|
|  <p>PO100MREC<br/>Marcus End Cap<br/>½" (1.3 cm) W<br/>1½" (3.8 cm) DIA<br/>\$38.50 pair*</p> |  <p>PO100NEFI<br/>Nerissa<br/>4½" (11.4 cm) W<br/>3¼" (8.3 cm) DIA<br/>\$93.50 pair*</p> |  <p>PO100PAFI<br/>Patience<br/>5¾" (14.3 cm) W<br/>5¾" (14.3 cm) H<br/>1½" (3.8 cm) DIA<br/>\$93.50 pair*</p> |  <p>PO100STFI<br/>Strato<br/>3½" (7.9 cm) W<br/>3½" (7.9 cm) DIA<br/>\$137.50 pair*</p> |  <p>PO100TBF<br/>Tybalt<br/>1¾" (4.8 cm) W<br/>1½" (4.1 cm) DIA<br/>\$60.50 pair*</p> |
|--|---|--|---|--|

**1" Glamour Resin Finials** fit the 1" pole, but DO NOT fit the 1" Hand Drawn Traverse System.

Note: 1" Cuff can be purchased separately and attached to any 1" Glamour Finial to make it compatible with the 1" Hand Drawn Traverse System. Once the 1" Cuff has been added to the 1" Glamour Finials, the Traditional Collar can also be purchased separately to give a more refined look. (Traditional Collar MUST be used in conjunction with the 1" Cuff.)

|  |   |  |  |   |   |
|--|---|--|--|---|---|
|  <p>PO100ASFI<br/>Astor<br/>1¾" (3.5 cm) W<br/>2¾" (6.0 cm) DIA<br/>\$71.50 pair*</p> |  <p>PO100CHFI<br/>Chaplin<br/>1¾" (4.4 cm) W<br/>2" (5.1 cm) DIA<br/>\$71.50 pair*</p> |  <p>PO100CLRF<br/>Clara<br/>2¼" (5.7 cm) W<br/>2¾" (6.7 cm) DIA<br/>\$71.50 pair*</p> |  <p>PO100FBFI<br/>Fairbanks<br/>3½" (7.9 cm) W<br/>2" (5.1 cm) DIA<br/>\$71.50 pair*</p> |  <p>PO100PIFI<br/>Pickford<br/>2¼" (5.7 cm) W<br/>1¾" (4.8 cm) DIA<br/>\$71.50 pair*</p> |  <p>PO100TUFI<br/>Turner<br/>2¼" (5.7 cm) W<br/>2¾" (7.0 cm) DIA<br/>\$71.50 pair*</p> |
|--|---|--|--|---|---|



\*Sold in pairs only.

# Portfolio 1"

Note: Only bases and 1" metal poles available in any Portfolio finish.

## 1" Pearl Jewel Resin Finials

are available in 3 Pearl colors: cream, grey, and white. Base available in any Portfolio finish. 1" Pearl Jewel Finials fit the 1" pole, but DO NOT fit the 1" Hand Drawn Traverse System.



|   |  |   |
|---|--|---|
|                          |                         |                          |
| PO100PEJWFI-CR<br>Cream Pearl Jewel<br>RESIN<br>2 1/4" (5.7 cm) W<br>2 3/8" (6.0 cm) DIA<br>\$71.50 pair* | PO100PEJWFI-GY<br>Grey Pearl Jewel<br>RESIN<br>2 1/4" (5.7 cm) W<br>2 3/8" (6.0 cm) DIA<br>\$71.50 pair* | PO100PEJWFI-WH<br>White Pearl Jewel<br>RESIN<br>2 1/4" (5.7 cm) W<br>2 3/8" (6.0 cm) DIA<br>\$71.50 pair* |

**Must specify** a Portfolio finish for the base of this finial.

**Note:** Remember that the Finial Base covers 1/4" (0.6 cm) of the pole. Finished pole length may need to be increased accordingly.

## 1" Transitional Pearl Resin Finials

are available in 3 Pearl colors: cream, grey, and white. Cuff available in any Portfolio finish. 1" Transitional Pearl Finials fit the 1" pole and the 1" Hand Drawn Traverse System.

|  |   |  |
|--|---|--|
|                                  |                                 |                                  |
| PO100PEFICU-CR<br>Cream Pearl with 1" Cuff<br>RESIN AND METAL<br>2 1/4" (5.7 cm) W<br>1 5/8" (4.1 cm) DIA<br>\$60.50 pair* | PO100PEFICU-GY<br>Grey Pearl with 1" Cuff<br>RESIN AND METAL<br>2 1/4" (5.7 cm) W<br>1 5/8" (4.1 cm) DIA<br>\$60.50 pair* | PO100PEFICU-WH<br>White Pearl with 1" Cuff<br>RESIN AND METAL<br>2 1/4" (5.7 cm) W<br>1 5/8" (4.1 cm) DIA<br>\$60.50 pair* |

**This finial fits both** 1" pole and 1" Hand Drawn Traverse track. Must specify a Portfolio finish for the Cuff on this finial.

**Note:** Remember that the 1" Cuff covers 5/8" (1.6 cm) of the pole or track. Finished pole length may need to be increased accordingly.

- Brushed Nickel 1" Cuff may be found on page 59.

## 1" Modern Pearl Resin Finials

are available in 3 Pearl colors: cream, grey, and white. 1" Modern Pearl Finials fit the 1" metal pole, but DO NOT fit the 1" Hand Drawn Traverse System.



|   |  |   |
|---|--|---|
|                |               |                |
| PO100PEFI-CR<br>Cream Pearl<br>RESIN<br>1 1/2" (3.8 cm) W<br>1 5/8" (4.1 cm) DIA<br>\$38.50 pair* | PO100PEFI-GY<br>Grey Pearl<br>RESIN<br>1 1/2" (3.8 cm) W<br>1 5/8" (4.1 cm) DIA<br>\$38.50 pair* | PO100PEFI-WH<br>White Pearl<br>RESIN<br>1 1/2" (3.8 cm) W<br>1 5/8" (4.1 cm) DIA<br>\$38.50 pair* |



**Note:** Modern Pearl finial looks great when paired with a 1" Braided Band or 1" Crystal Band; must be purchased separately. See 1" Finial Accessories for details.

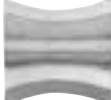

**1" California Resin Finials** fit the 1" pole, but DO NOT fit the 1" Hand Drawn Traverse System.

Note: 1" Cuff can be purchased separately and attached to any 1" California Finial to make it compatible with the 1" Hand Drawn Traverse System.

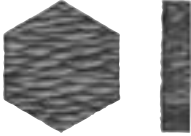
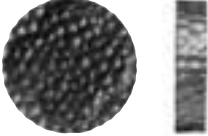
|  |   |  |   |
|--|---|--|---|
|  <p><b>PO100BEFI</b><br/>Beverly<br/>3½" (8.9 cm) W<br/>2" (5.1 cm) DIA<br/>\$60.50 pair*</p> |  <p><b>PO100MEFI</b><br/>Melrose<br/>2¾" (6.0 cm) W<br/>2¼" (5.7 cm) DIA<br/>\$49.50 pair*</p> |  <p><b>PO100ROFI</b><br/>Rodeo<br/>1¾" (4.4 cm) W<br/>2" (5.1 cm) DIA<br/>\$49.50 pair*</p> |  <p><b>PO100WIFI</b><br/>Wilshire<br/>2¾" (6.0 cm) W<br/>2¾" (6.0 cm) DIA<br/>\$49.50 pair*</p> |
|--|---|--|---|

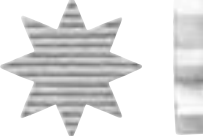









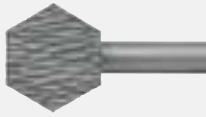
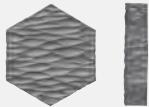

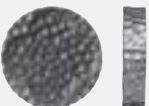

|   |  |   |   |
|---|--|---|---|
|  <p><b>PO100LGEC</b><br/>Laguna End Cap<br/>¾" (1.9 cm) W<br/>3¾" (8.6 cm) DIA<br/>\$49.50 pair*</p> |  <p><b>PO100NEEC</b><br/>Newport End Cap<br/>¾" (1.9 cm) W<br/>3¼" (8.3 cm) DIA<br/>\$49.50 pair*</p> |  <p><b>PO100SUEC</b><br/>Sunset End Cap<br/>¾" (1.9 cm) W<br/>3½" (8.9 cm) DIA<br/>\$49.50 pair*</p> |  <p><b>PO100VEEC</b><br/>Venice End Cap<br/>¾" (1.9 cm) W<br/>3½" (8.9 cm) DIA<br/>\$49.50 pair*</p> |
|---|--|---|---|

\*Sold in pairs only.

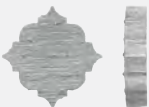
**1" California Front-Facing Finial Kits** fit both the 1" pole and the 1" Hand Drawn Traverse System.

Note: Each 1" Finial Kit includes: 1 pair California End Caps, 1 pair 1" Holdback Medallion Bands, and 1 pair Luna End Caps.

Note: 1/4" (0.6 cm) between pole and finial when installed.



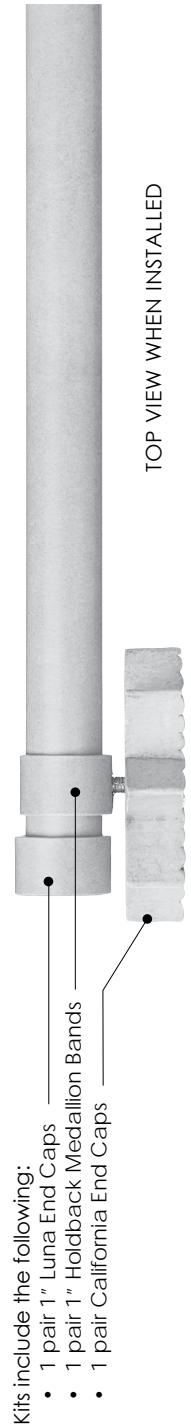



|  |   |  |  |  |
|--|---|--|--|--|
|  <p>PO100LGKIT<br/>Laguna Finial Kit</p> <p>\$104.50 Kit</p>   | <p><b>Note:</b> 1/4" (0.6 cm) between pole and finial when installed.</p> <p>This front-facing finial extends 3/4" (1.9 cm) beyond the end of the pole, and covers 2 1/2" (6.4 cm) of the end of the pole or track.</p> <p>Functional pole length may need to be increased accordingly.</p> |  <p>Laguna End Cap</p> <p>RESIN</p> <p>3 3/8" (8.6 cm) DIA<br/>3/4" (1.9 cm) THICK</p> <p>pair (included)</p>   |  <p>1" Holdback Medallion Band</p> <p>METAL</p> <p>3/4" (1.9 cm) W x<br/>1 1/16" (2.7 cm) ID x<br/>1 3/16" (3.1 cm) OD</p> <p>pair (included)</p>   |  <p>1" Luna End Cap</p> <p>METAL</p> <p>3/4" (1.9 cm) W<br/>1 1/4" (3.2 cm) DIA</p> <p>pair (included)</p>   |
|  <p>PO100NEKIT<br/>Newport Finial Kit</p> <p>\$104.50 Kit</p>  | <p><b>Note:</b> 1/4" (0.6 cm) between pole and finial when installed.</p> <p>This front-facing finial extends 5/8" (1.6 cm) past the end of the pole and covers 2 5/8" (6.7 cm) of the end of the pole.</p> <p>Functional pole length may need to be increased accordingly.</p>             |  <p>Newport End Cap</p> <p>RESIN</p> <p>3 1/4" (8.3 cm) DIA<br/>3/4" (1.9 cm) THICK</p> <p>pair (included)</p>  |  <p>1" Holdback Medallion Band</p> <p>METAL</p> <p>3/4" (1.9 cm) W x<br/>1 1/16" (2.7 cm) ID x<br/>1 3/16" (3.1 cm) OD</p> <p>pair (included)</p>   |  <p>1" Luna End Cap</p> <p>METAL</p> <p>3/4" (1.9 cm) W<br/>1 1/4" (3.2 cm) DIA</p> <p>pair (included)</p>   |
|  <p>PO100SUKIT<br/>Sunset Finial Kit</p> <p>\$104.50 Kit</p> | <p><b>Note:</b> 1/4" (0.6 cm) between pole and finial when installed.</p> <p>This front-facing finial extends 3/4" (1.9 cm) past the end of the pole and covers 2 3/4" (7.0 cm) of the end of the pole.</p> <p>Functional pole length may need to be increased accordingly.</p>             |  <p>Sunset End Cap</p> <p>RESIN</p> <p>3 1/2" (8.9 cm) DIA<br/>3/4" (1.9 cm) THICK</p> <p>pair (included)</p> |  <p>1" Holdback Medallion Band</p> <p>METAL</p> <p>3/4" (1.9 cm) W x<br/>1 1/16" (2.7 cm) ID x<br/>1 3/16" (3.1 cm) OD</p> <p>pair (included)</p> |  <p>1" Luna End Cap</p> <p>METAL</p> <p>3/4" (1.9 cm) W<br/>1 1/4" (3.2 cm) DIA</p> <p>pair (included)</p> |
|  <p>PO100VEKIT<br/>Venice Finial Kit</p> <p>\$104.50 Kit</p> | <p><b>Note:</b> 1/4" (0.6 cm) between pole and finial when installed.</p> <p>This front-facing finial extends 3/4" (1.9 cm) beyond the end of the pole, and covers 2 3/4" (7.0 cm) of the end of the pole or track.</p> <p>Functional pole length may need to be increased accordingly.</p> |  <p>Venice End Cap</p> <p>RESIN</p> <p>3 1/2" (8.9 cm) DIA<br/>3/4" (1.9 cm) THICK</p> <p>pair (included)</p> |  <p>1" Holdback Medallion Band</p> <p>METAL</p> <p>3/4" (1.9 cm) W x<br/>1 1/16" (2.7 cm) ID x<br/>1 3/16" (3.1 cm) OD</p> <p>pair (included)</p> |  <p>1" Luna End Cap</p> <p>METAL</p> <p>3/4" (1.9 cm) W<br/>1 1/4" (3.2 cm) DIA</p> <p>pair (included)</p> |



\*Sold in pairs only.

**1" Tried & True Resin Finials** fit the 1" pole, but DO NOT fit the 1" Hand Drawn Traverse System.

Note: 1" Cuff can be purchased separately and attached to any 1" Tried & True Resin Finial to make it compatible with the 1" Hand Drawn Traverse System.

|  |   |  |  |   |  |
|--|---|--|--|---|--|
|  <p>PO100CEEC<br/>Celia End Cap<br/>1 1/8" (2.9 cm) W<br/>1 1/2" (3.8 cm) DIA<br/>\$38.50 pair*</p> |  <p>PO100CLFI<br/>Clementine<br/>2 3/4" (7.0 cm) W<br/>2" (5.1 cm) DIA<br/>\$49.50 pair*</p> |  <p>PO100ELFI<br/>Eleri<br/>3 1/4" (8.3 cm) W<br/>3 1/8" (7.9 cm) DIA<br/>\$71.50 pair*</p> |  <p>PO100KEFI<br/>Keaton<br/>2 3/8" (6.0 cm) W<br/>2 5/8" (6.7 cm) DIA<br/>\$49.50 pair*</p> |  <p>PO100MAFI<br/>Marion<br/>2 1/8" (5.4 cm) W<br/>2 3/8" (6.0 cm) DIA<br/>\$49.50 pair*</p> |  <p>PO100NIFI<br/>Nicolette<br/>3 3/4" (9.5 cm) W<br/>2 3/4" (7.0 cm) DIA<br/>\$71.50 pair*</p> |
|--|---|--|--|---|--|

|   |  |   |   |   |
|---|--|---|---|---|
|  <p>PO100ODFI<br/>Odette<br/>2 3/8" (6.0 cm) W<br/>1 3/4" (4.4 cm) DIA<br/>\$49.50 pair*</p> |  <p>PO100PAEC<br/>Paige End Cap<br/>1" (2.5 cm) W<br/>1 1/2" (3.8 cm) DIA<br/>\$38.50 pair*</p> |  <p>PO100SEFI<br/>Seraphine<br/>4 1/2" (11.4 cm) W<br/>2 3/8" (6.0 cm) DIA<br/>\$71.50 pair*</p> |  <p>PO100VNFI<br/>Verne<br/>1 7/8" (4.8 cm) W<br/>2" (5.1 cm) DIA<br/>\$49.50 pair*</p> |  <p>PO100VLF1<br/>Violet<br/>3 5/8" (9.2 cm) W<br/>2 1/2" (6.4 cm) DIA<br/>\$93.50 pair*</p> |
|---|--|---|---|---|

\*Sold in pairs only.





1" Finial Accessories

Slide these onto your 1" pole for a Glamorous look.

- These 1" Bands can be used on a 1" pole in 2 ways:
1. against the base of a 1" finial for a touch of glamour
  2. anywhere on the 1" pole for additional decoration



Add this for a Transitional look or to gain compatibility with the 1" Hand Drawn Traverse System.

Add this turned element for a Traditional look.

|   |   |   |   |   |   |
|---|---|---|---|---|---|
| <p>Verify the compatibility of your chosen Finial and Accessory in the chart below.</p> |  <p><b>PO100BRBAND</b><br/>1" Braided Band<br/>5/8" (1.6 cm) W<br/>1 1/16" (2.7 cm) ID<br/>1 5/8" (4.1 cm) OD</p> <ul style="list-style-type: none"> <li>• resin; available in any Portfolio Finish</li> <li>• not recommended for 1" Hand Drawn Traverse System</li> </ul> <p><b>\$38.50 ea</b></p> |  <p><b>PO100CRMEBAND</b><br/>1" Crystal Band<br/>5/8" (1.6 cm) W<br/>1 1/16" (2.7 cm) ID<br/>1 5/8" (4.1 cm) OD</p> <ul style="list-style-type: none"> <li>• metal; available only in dark metal with inlaid crystals</li> <li>• not recommended for 1" Hand Drawn Traverse System</li> </ul> <p><b>\$33.00 ea</b></p> |  <p><b>PO100CUFF</b><br/>1" Cuff<br/>3/4" (1.9 cm) W<br/>1 1/4" (3.2 cm) DIA</p> <ul style="list-style-type: none"> <li>• metal; available in any Portfolio finish</li> <li>• covers 3/8" of the pole; finished pole length may need to be increased accordingly</li> </ul> <p><b>\$33.00 pair</b></p> |  <p><b>POTRADCO</b><br/>Traditional Collar<br/>5/8" (1.6 cm) W<br/>1 1/8" (2.9 cm) DIA</p> <ul style="list-style-type: none"> <li>• metal; available in any Portfolio finish</li> <li>• must be used with the 1" Cuff</li> <li>• installs between the Finial and 1" Cuff</li> </ul> <p><b>\$33.00 pair</b></p> |   |
|   | 1" Modern Metal Finials   | •   | •   |   |   |
|   | 1" Transitional Metal Finials   |   |   | (included)  | •   |
|   | 1" Textured Metal Finials   | •   | •   | •   |   |
|   | 1" Glamour Resin Finials  | •   | •   | •   | must use with 1" Cuff, ordered separately |
|   | 1" Transitional Pearl Resin Finials   |   |   | (included)  |   |
|   | 1" Modern Pearl Resin Finials   | •   | •   |   |   |
|   | 1" California Resin Finials   | •   | •   | •   |   |
|   | 1" Tried & True Resin Finials   | •   | •   | •   |   |

**TIP:** These two items are also available in Quick Ship Brushed Nickel finish. Refer to Quick Ship Metal 1" Price List for more information.

1" Medallion Bands

|   |  |
|---|--|
|  <p><b>POROBAND</b><br/>1" Rosaline Medallion Band<br/>BAND: METAL<br/>3/4" (1.9 cm) W x<br/>1 1/16" (2.7 cm) ID x<br/>1 3/16" (3.1 cm) OD<br/>MEDALLION: METAL<br/>2 1/8" (5.4 cm) DIA<br/>7/8" (2.2 cm) D</p> <ul style="list-style-type: none"> <li>• covers 3/4" of the pole; finished pole length may need to be increased accordingly</li> </ul> <p><b>\$55.00 pair*</b></p> |  <p><b>POMEBAND</b><br/>1" Holdback Medallion Band<br/>METAL<br/>3/4" (1.9 cm) W x<br/>1 1/16" (2.7 cm) ID x<br/>1 3/16" (3.1 cm) OD</p> <ul style="list-style-type: none"> <li>• covers 3/4" of the pole; finished pole length may need to be increased accordingly</li> </ul> <p><b>\$33.00 pair*</b></p> |
|---|--|

**Note:** Attaches any Holdback Medallion to the front of a 1" pole. Holdback Medallion sold separately.

**Common uses for 1" Medallion Bands:**





1. repeated decorative embellishment along the length of a pole
2. hold gathered rod pocket drapery panel in place
3. ring stop

\*Sold in pairs only.

**1" Rings** fit the 1" pole.





Available in any Portfolio finish.

Note: Ring drop indicates distance from bottom of pole to bottom of ring. A ring's drop changes on different diameter poles.





|  |   |   |   |
|--|---|---|---|
|   |    |    |    |
| <p>PO100AVRI<br/>Ava Ring</p> <p>RESIN<br/>1/4" (0.6 cm) W x<br/>1 5/8" (4.1 cm) H<br/>1 1/4" (3.2 cm) ID x<br/>1 5/8" (4.1 cm) OD<br/>1/2" (1.3 cm) DROP</p> <p>\$6.60 ea</p> | <p>PO100JARI<br/>Jacqueline Ring</p> <p>RESIN<br/>3/8" (1.0 cm) W x<br/>1 5/8" (4.1 cm) H<br/>1 1/4" (3.2 cm) ID x<br/>1 5/8" (4.1 cm) OD<br/>1/2" (1.3 cm) DROP</p> <p>\$6.60 ea</p> | <p>PO100SCRI<br/>Small C Ring</p> <p>METAL<br/>3/16" (0.5 cm) W<br/>1 1/2" (3.8 cm) ID x<br/>2" (5.1 cm) OD<br/>3/4" (1.9 cm) DROP</p> <p>\$5.50 ea</p> | <p>PO100SWRI<br/>Swing Ring</p> <p>METAL<br/>3/16" (0.5 cm) W<br/>1 1/2" (3.8 cm) ID<br/>2" (5.1 cm) OD<br/>3/4" (1.9 cm) DROP</p> <p>\$6.60 ea</p> |

• Use this bypass ring with Gregory Bypass Support Brackets

**1" Brackets** fit the 1" pole. Note: Return indicates distance from wall to center of pole. Projection indicates distance from wall to back of pole.

|  |  |   |  |
|--|--|---|--|
|   |                          |   |   |
| <p>PO100MCMBK<br/>1" Metal Ceiling Mount</p> <p>2" (5.1 cm) W x<br/>2 1/4" (5.7 cm) H x<br/>2" (5.1 cm) D;</p> <p>Base: 2" (5.1 cm) DIA<br/>Cradle: 1" (2.5 cm) W x<br/>1 1/4" (3.2 cm) OD x<br/>1 1/8" (2.9 cm) ID</p> <p>Drop (distance from ceiling to bottom of pole): 2 1/8" (5.4 cm)</p> <p>\$38.50 ea</p> | <p>PO100MIBK<br/>1" Metal Inside Mount</p> <p>3/4" (1.9 cm) W x<br/>1 1/8" (2.9 cm) H x<br/>1 5/8" (4.1 cm) D</p> <p>\$66.00 pair*</p> | <p>PO100CESBK<br/>Cerise Single</p> <p>METAL<br/>3 1/8" (7.9 cm) DIA BASE x<br/>4 3/8" (11.1 cm) D;<br/>3 1/2" (8.9 cm) RET,<br/>3" (7.6 cm) PROJ</p> <p>\$55.00 ea</p> | <p>PO100CEDBK<br/>Cerise Double</p> <p>METAL<br/>3 1/8" (7.9 cm) DIA BASE x<br/>7 1/2" (19.1 cm) D;<br/>6 1/2" (16.5 cm) FRONT RET,<br/>3 1/2" (8.9 cm) BACK RET;<br/>6" (15.2 cm) FRONT PROJ,<br/>3" (7.6 cm) BACK PROJ<br/>Both Cradles hold 1" pole</p> <p>\$71.50 ea</p> |

Note: Pair includes right and left (set screw located in back when installed)

|  |   |   |  |  |
|--|---|---|--|--|
| <p><b>Bypass Support Brackets</b></p>  |   |   |  |  |
|   |    |    |    |    |
| <p>PO100GRSBK<br/>Gregory Single*</p> <p>METAL<br/>3/4" (1.9 cm) W x<br/>3 3/4" (9.5 cm) H x<br/>4 1/8" (10.5 cm) D;<br/>3 1/2" (8.9 cm) RET,<br/>3" (7.6 cm) PROJ</p> <p>\$38.50 ea</p> | <p>PO100GRDBK<br/>Gregory Double*</p> <p>METAL<br/>3/4" (1.9 cm) W x<br/>3 3/4" (9.5 cm) H x<br/>6 5/8" (16.8 cm) D;<br/>6" (15.2 cm) FRONT RET,<br/>3" (7.6 cm) BACK RET;<br/>5 1/2" (14.0 cm) FRONT PROJ,<br/>2 1/2" (6.4 cm) BACK PROJ<br/>Both Cradles hold 1" pole</p> <p>\$44.00 ea</p> | <p>PO100LASBK<br/>Laurence 3" Single</p> <p>METAL<br/>3/4" (1.9 cm) W x<br/>3 3/4" (9.5 cm) H x<br/>4 1/8" (10.5 cm) D;<br/>3 1/2" (8.9 cm) RET,<br/>3" (7.6 cm) PROJ</p> <p>\$44.00 ea</p> | <p>PO100LAS6BK<br/>Laurence 6" Single</p> <p>METAL<br/>3/4" (1.9 cm) W x<br/>3 3/4" (9.5 cm) H x<br/>6 3/4" (17.1 cm) D;<br/>6" (15.2 cm) RET,<br/>5 1/2" (14.0 cm) PROJ</p> <p>\$49.50 ea</p> | <p>PO100LADBK<br/>Laurence 6" Double</p> <p>METAL<br/>3/4" (1.9 cm) W x<br/>3 3/4" (9.5 cm) H x<br/>6 3/4" (17.1 cm) D;<br/>6" (15.2 cm) FRONT RET,<br/>3" (7.6 cm) BACK RET;<br/>5 1/2" (14.0 cm) FRONT PROJ,<br/>2 1/2" (6.4 cm) BACK PROJ<br/>Both Cradles hold 1" pole</p> <p>\$49.50 ea</p> |

\*CAUTION: Gregory Brackets do not have full cradles. Self-threading screw installs through bottom of cradle and into 1" pole to secure it. Laurence Brackets must be installed at each end to secure 1" pole.

• Use with Small C Ring.

\*Sold in pairs only.

**1" Smooth Metal Poles**

Note: All orders with poles and/or traverse track will incur a \$10.00 packaging fee per order.

|            |            |             |             |             |             |             |             |
|------------|------------|-------------|-------------|-------------|-------------|-------------|-------------|
| PO100SM02  | PO100SM04  | PO100SM06   | PO100SM08   | PO100SM10   | PO100SM12   | PO100SM14   | PO100SM16   |
| 2'         | 4'         | 6'          | 8'          | 10'         | 12'         | 14'         | 16'         |
| \$35.20 ea | \$70.40 ea | \$105.60 ea | \$140.80 ea | \$176.00 ea | \$211.20 ea | \$246.40 ea | \$281.60 ea |

**1" Accessories**

Note: Hinged Resin Elbow and 41" Metal Wand available in any Portfolio finish.

|   |   |   |   |
|---|---|---|---|
|  |  |  |  |
| PO100REL  | POAC36WAND  | POAC48WAND  | POME41WAND  |
| 1" Hinged Resin Elbow   | 36" Clear Acrylic Wand  | 48" Clear Acrylic Wand  | 41" Metal Wand  |
| 1 1/8" (2.9 cm) DIA   | ACRYLIC, CLEAR ONLY   | ACRYLIC, CLEAR ONLY   | 5/8" (1.6 cm) DIA   |
| 3/4" (8.3 cm)   | 1/2" (1.3 cm) DIA   | 1/2" (1.3 cm) DIA   | 41" (104.1 cm) LENGTH   |
| TOTAL LENGTH  | 36" (91.4 cm) LENGTH  | 48" (121.9 cm) LENGTH   |   |
| 1 5/8" (4.1 cm) each side when bent   |   |   |   |
| \$33.00 ea  | \$44.00 ea  | \$49.50 ea  | \$44.00 ea  |

\*Sold in pairs only.

# 1" Hand Drawn Traverse System RECOMMENDED FOR LIGHTWEIGHT DRAPERIES

All orders with poles and/or traverse track will incur a \$10.00 packaging fee per order.

## 1" Hand Drawn Traverse System INCLUDES:

- Track(s): Continuous track available up to 8'; spliced lengths available up to 16'.
- Brackets
- Components: Glides and Glide Stop(s)\*
- 48" Clear Acrylic Wand(s)\*

*\*Note: Each Center Draw Track includes 2 Glide Stops and 2 Acrylic Wands. Each One-Way Draw Track includes 1 Glide Stop and 1 Acrylic Wand.*

## Finials sold separately.

- 1" Finials with a Cuff must be ordered with all 1" Hand Drawn Traverse Systems.
- Only 1" Transitional Metal Finials and 1" Transitional Pearl Resin Finials can attach to the track without modification. (Their Cuff is included.)
- Any 1" Portfolio Finial can be modified to fit the 1" Hand Drawn Traverse track with the addition of a 1" Cuff, sold separately.
- Finials must have a Cuff to attach to the track.
- If a Traditional Collar is added to the 1" Transitional Finial or the 1" Glamour Finial with Cuff, it will still fit the track.

Maximum drapery weight - 2 lbs/ft.

Available in any Portfolio Finish.

## Order in 3 Easy Steps:

Step 1: Select your Draw.

Step 2: Select your Bracket.

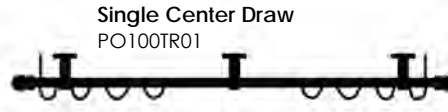

Single Center Draw  
PO100TR01

**Available Brackets**  
3½" Single  
6" Single  
Ceiling Mount

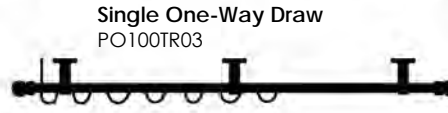

Single One-Way Draw  
PO100TR03

**Available Brackets**  
3½" Single  
6" Single  
Ceiling Mount



Double Center Draw  
PO100TR05

**Available Brackets**  
Double Bracket  
Ceiling Mount



Double One-Way Draw  
PO100TR07

**Available Brackets**  
Double Bracket  
Ceiling Mount

Step 3: Purchase your Finials, sold separately.

**Single Center Draw** Includes: 1 track, single brackets (1 per 3-4 feet), glides (4 per foot), 2 glide stops, and 2 clear acrylic wands.

Track available in 8 ft continuous lengths only. Any track length over 8 ft must be spliced together.

Must specify type of bracket.

|           |                     | 2'       | 4'       | 6'       | 8'       | 10'      | 12'      | 14'      | 16'        |
|-----------|---------------------|----------|----------|----------|----------|----------|----------|----------|------------|
| PO100TR01 | 3½" (8.9 cm) return | \$132.00 | \$264.00 | \$396.00 | \$528.00 | \$660.00 | \$792.00 | \$924.00 | \$1,056.00 |

**Single One-way Draw** Includes: 1 track, single brackets (1 per 3-4 feet), glides (4 per foot), 1 glide stop, and 1 clear acrylic wand.

Must specify type of bracket.

|           |                     | 2'       | 4'       | 6'       | 8'       | 10'      | 12'      | 14'      | 16'        |
|-----------|---------------------|----------|----------|----------|----------|----------|----------|----------|------------|
| PO100TR03 | 3½" (8.9 cm) return | \$132.00 | \$264.00 | \$396.00 | \$528.00 | \$660.00 | \$792.00 | \$924.00 | \$1,056.00 |

**Double Center Draw** Includes: 2 tracks, double brackets (1 per 3-4 feet), glides (4 per foot), 4 glide stops, and 4 clear acrylic wands.

Must specify type of bracket.

|           |   | 2'       | 4'       | 6'       | 8'         | 10'        | 12'        | 14'        | 16'        |
|-----------|---|----------|----------|----------|------------|------------|------------|------------|------------|
| PO100TR05 | 6" (15.2 cm) front return;<br>3" (7.6 cm) back return | \$264.00 | \$528.00 | \$792.00 | \$1,056.00 | \$1,320.00 | \$1,584.00 | \$1,848.00 | \$2,112.00 |

**Double One-way Draw** Includes: 2 tracks, double brackets (1 per 3-4 feet), glides (4 per foot), 2 glide stops, and 2 clear acrylic wands.

Must specify type of bracket.





|           |   | 2'       | 4'       | 6'       | 8'         | 10'        | 12'        | 14'        | 16'        |
|-----------|---|----------|----------|----------|------------|------------|------------|------------|------------|
| PO100TR07 | 6" (15.2 cm) front return;<br>3" (7.6 cm) back return | \$264.00 | \$528.00 | \$792.00 | \$1,056.00 | \$1,320.00 | \$1,584.00 | \$1,848.00 | \$2,112.00 |

\*Sold in pairs only.

**Included in System: 1" Hand Drawn Traverse Brackets**

Note: Brackets must be installed every 3 - 4 feet. Bracket return indicates distance from wall to center of track. Bracket projection indicates distance from wall to back of track. See System Quantity Chart for quantity of Brackets included with each system. Additional Brackets may be ordered separately.

Bracket style must be specified on your order.

|  |  |  |   |
|--|--|--|---|
|  <p>PO100TRSBK</p> <p>1" Traverse<br/>3½" Single</p> <p>METAL<br/>2⅞" (5.4 cm) DIA<br/>BACK PLATE,<br/>1" (2.5 cm) DIA STEM x<br/>4⅞" (10.5 cm) D;<br/>3½" (8.9 cm) RET,<br/>3" (7.6 cm) PROJ</p> <p>\$38.50 ea</p> |  <p>PO100TRS6BK</p> <p>1" Traverse<br/>6" Single</p> <p>METAL<br/>2⅞" (5.4 cm) DIA<br/>BACK PLATE,<br/>1" (2.5 cm) DIA STEM x<br/>6¾" (17.1 cm) D;<br/>6" (15.2 cm) RET,<br/>5½" (14.0 cm) PROJ</p> <p>\$38.50 ea</p> |  <p>PO100TRDBK</p> <p>1" Traverse Double</p> <p>METAL<br/>2⅞" (5.4 cm) DIA<br/>BACK PLATE,<br/>1" (2.5 cm) DIA STEM x<br/>6¾" (17.1 cm) D;<br/>6" (15.2 cm) FRONT RET,<br/>3" (7.6 cm) BACK RET;<br/>5½" (14.0 cm)<br/>FRONT PROJ,<br/>2½" (6.4 cm)<br/>BACK PROJ</p> <p>\$38.50 ea</p> |  <p>PO100TRCMBK</p> <p>1" Traverse Single<br/>Ceiling Mount</p> <p>METAL<br/>2⅞" (5.4 cm) DIA<br/>CEILING PLATE,<br/>1" (2.5 cm) DIA STEM,<br/>2¼" (5.7 cm) H x<br/>3¼" ( 8.3 cm) D x<br/>DROP (distance from<br/>ceiling to bottom<br/>of pole):<br/>2½" (6.4 cm)</p> <p>\$38.50 ea</p> |
|--|--|--|---|

**Included in System: 1" Hand Drawn Traverse Components**

Components will be provided in the color that best matches the Portfolio finish, unless otherwise specified. See Component Color Chart. See System Quantity Chart for quantity of glides included with each system. Additional components may be ordered separately.



**Glides**

**Wand**

|   |  |   |  |   |  |
|---|--|---|--|---|--|
| <p>¾" (1.0 cm) W x<br/>1⅞" (2.9 cm) H x<br/>¼" (0.6 cm) D;<br/>⅝" (1.6 cm) DROP<br/>(from bottom of track<br/>to bottom of eyelet<br/>interior when installed)</p> <ul style="list-style-type: none"> <li>White Glide may be substituted. Please specify on order.</li> </ul> <p><b>Note:</b> White Glide can be useful when installing sheer and translucent fabrics onto the 1" Hand Drawn Traverse System.</p> |  <p>PO100GLIDE-BZ</p> <p>Standard Wheeled<br/>Glide - Bronze</p> <p>\$ .55 each</p> |  <p>PO100GLIDE-CH</p> <p>Standard<br/>Wheeled Glide -<br/>Champagne</p> <p>\$ .55 each</p> |  <p>PO100GLIDE-GO</p> <p>Standard Wheeled<br/>Glide - Gold</p> <p>\$ .55 each</p> |  <p>PO100GLIDE-WH</p> <p>Standard Wheeled<br/>Glide - White</p> <p>\$ .55 each</p> |  <p>POAC48WAND</p> <p>48" Clear Acrylic<br/>Wand</p> <p>ACRYLIC, CLEAR ONLY<br/>½" (1.3 cm) DIA<br/>48" (121.9 cm) LENGTH</p> <p>\$49.50 each</p> |
|---|--|---|--|---|--|

**Glide Stops – anchor the drapery panel at the end of the track.**

**Splicer**

|  |  |   |  |   |  |
|--|--|---|--|---|--|
| <p>¾" (1.0 cm) W x<br/>½" (1.3 cm) H x<br/>⅜" (0.5 cm) D;<br/>¼" (0.6 cm) DROP<br/>(from bottom of track<br/>to bottom of eyelet<br/>interior when installed)</p> <ul style="list-style-type: none"> <li>White Glide Stop may be substituted. Please specify on order.</li> </ul> <p><b>Note:</b> White Glide Stop can be useful when installing sheer and translucent fabrics onto the 1" Hand Drawn Traverse System.</p> |  <p>PO100GSTOP-BZ</p> <p>Glide Stop - Bronze</p> <p>\$ .55 each</p> |  <p>PO100GSTOP-CH</p> <p>Glide Stop -<br/>Champagne</p> <p>\$ .55 each</p> |  <p>PO100GSTOP-GO</p> <p>Glide Stop - Gold</p> <p>\$ .55 each</p> |  <p>PO100GSTOP-WH</p> <p>Glide Stop - White</p> <p>\$ .55 each</p> |  <p>PO100TRSPL<br/>Track Splicer</p> <ul style="list-style-type: none"> <li>connects the ends of two tracks</li> <li>installs into top channel</li> <li>included with all systems over 8"</li> </ul> <p>\$4.40 each</p> |
|--|--|---|--|---|--|

\*Sold in pairs only.



# 1" Hand Drawn Traverse System

## COMPONENT COLOR CHART

| Component* Color   | Champagne  | Bronze  | Gold   | White                       |
|--|--|---|--|-----------------------------|
| <b>Portfolio Finish</b>                                    | ANDIRON<br>CINNAMON<br>HALO<br>SHIMMER<br>SILVER MAPLE<br>SPUN GOLD<br>STARLET<br>TITANIUM<br>URBAN BRONZE | AMULET<br>ART BRONZE<br>BARNWOOD<br>BLACK<br>DARK CHOCOLATE<br>GOSSAMER<br>JAVA<br>MINK<br>MOONLIGHT<br>NEW AGE BRONZE<br>SPICEWOOD<br>TIMBER | ANTIQUE GOLD<br>ANTIQUE GOLD LEAF<br>ETERNAL<br>FIRELIGHT<br>GOLDENROD<br>MYSTIC | LINEN<br>PARCHMENT<br>WHITE |
| *White may be substituted<br>(Must be specified on order.) | Yes  | Yes   | Yes  | -                           |



\*Components include Standard Wheeled Glide and Glide Stop.



## SYSTEM QUANTITY CHART

| Quantity included per set will be based on total system length | Continuous Track Length |    |    |    |    |    |    | Spliced Track Length |     |     |     |     |     |     |     |
|--|-------------------------|----|----|----|----|----|----|----------------------|-----|-----|-----|-----|-----|-----|-----|
|  | 2'                      | 3' | 4' | 5' | 6' | 7' | 8' | 9'                   | 10' | 11' | 12' | 13' | 14' | 15' | 16' |
| Glides (4 per foot, includes Glide Stop)                       | 8                       | 12 | 16 | 20 | 24 | 28 | 32 | 36                   | 40  | 44  | 48  | 52  | 56  | 60  | 64  |
| Brackets (1 per every 3-4 feet)                                | 2                       | 2  | 2  | 3  | 3  | 3  | 4  | 4                    | 4   | 5   | 5   | 5   | 6   | 6   | 6   |

\*Sold in pairs only.

1 1/4" Modern Metal Finials fit the 1 1/4" metal pole.

|   |   |   |  |   |   |
|---|---|---|--|---|---|
|  |  |  |           |        |  |
| PO114COFI<br>Cole<br>3 3/4" (8.3 cm) W<br>1 1/2" (3.8 cm) DIA<br>\$93.50 pair*    | PO114ELAFI<br>Ella<br>1 1/2" (3.8 cm) W<br>1 5/8" (4.1 cm) DIA<br>\$71.50 pair*   | PO114EMFI<br>Elm<br>1 1/8" (2.9 cm) W<br>2" (5.1 cm) DIA<br>\$71.50 pair*         | PO114EMFIGL<br>Elm - Smoke Glass<br>1 1/8" (2.9 cm) W<br>2" (5.1 cm) DIA<br>\$104.50 pair* | PO114KNFI<br>Knox - Crystal<br>1 1/4" (3.2 cm) W<br>2 1/4" (5.7 cm) DIA<br>\$137.50 pair* | PO114LXFI<br>Lex<br>1 3/4" (4.4 cm) W<br>2" (5.1 cm) DIA<br>\$60.50 pair*           |



|  |   |   |
|--|---|---|
|     |  |                  |
| PO114SKEC<br>Skye End Cap<br>3/4" (1.9 cm) W<br>1 1/2" (3.8 cm) DIA<br>\$38.50 pair* | PO114NOFI<br>Nora<br>2" (5.1 cm) W<br>2 1/4" (5.7 cm) DIA<br>\$104.50 pair*       | PO114NOFIGL<br>Nora - Mercury Glass<br>2 1/8" (5.4 cm) W<br>2 3/8" (6.0 cm) DIA<br>\$137.50 pair* |

*Skye End Cap covers 5/8" (1.6 cm) of end of pole; finished pole length may need to be increased accordingly.*

1 1/4" Transitional Metal Finials fit the 1 1/4" metal pole.

Note: Each Transitional Metal Finial covers 5/8" (1.6 cm) of pole; finished pole length may need to be increased accordingly.

|   |  |  |   |  |  |
|---|--|--|---|--|--|
|              |                 |           |                            |                     |         |
| PO114COFICU<br>Cole with 1 1/4" Cuff<br>4" (10.2 cm) W<br>1 1/2" (3.8 cm) DIA<br>\$121.00 pair* | PO114ELAFICU<br>Ella with 1 1/4" Cuff<br>2 1/4" (5.7 cm) W<br>1 5/8" (4.1 cm) DIA<br>\$99.00 pair* | PO114EMFICU<br>Elm with 1 1/4" Cuff<br>1 7/8" (4.8 cm) W<br>2" (5.1 cm) DIA<br>\$99.00 pair* | PO114EMFIGLCU<br>Elm - Smoke Glass with 1 1/4" Cuff<br>1 7/8" (4.8 cm) W<br>2" (5.1 cm) DIA<br>\$132.00 pair* | PO114KNFICU<br>Knox - Crystal with 1 1/4" Cuff<br>2" (5.1 cm) W<br>2 1/4" (5.7 cm) DIA<br>\$165.00 pair* | PO114LXFICU<br>Lex with 1 1/4" Cuff<br>2 1/2" (6.4 cm) W<br>2" (5.1 cm) DIA<br>\$88.00 pair* |

|  |  |  |
|--|--|--|
|   |                 |                                   |
| PO114SKEC<br>Skye End Cap<br>3/4" (1.9 cm) W<br>1 1/2" (3.8 cm) DIA<br>\$38.50 pair* | PO114NOFICU<br>Nora with 1 1/4" Cuff<br>2 3/4" (7.0 cm) W<br>2 1/4" (5.7 cm) DIA<br>\$132.00 pair* | PO114NOFIGLCU<br>Nora - Mercury Glass with 1 1/4" Cuff<br>2 7/8" (7.3 cm) W<br>2 3/8" (6.0 cm) DIA<br>\$165.00 pair* |





Accessory: Traditional Collar

|   |   |
|---|---|
|      | <b>Adding Traditional Collar</b> increases the width of the finial by 5/8" (1.6 cm)   |
| POTRADCO<br>Traditional Collar<br>5/8" (1.6 cm) W<br>1 1/8" (2.9 cm) DIA<br>\$33.00 pair* | <ul style="list-style-type: none"> <li>metal available in any Portfolio finish.</li> <li>must be used with the 1 1/4" Cuff</li> <li>install between the Finial and 1 1/4" Cuff</li> </ul> |

\*Sold in pairs only.

**1 1/4" Glamour Resin Finials** fit the 1 1/4" pole.

Note: 1 1/4" Cuff can be purchased separately and attached to any 1 1/4" Glamour Finial to give it a more transitional look. Once the 1 1/4" Cuff has been added to the 1 1/4" Glamour Finials, the Traditional Collar can also be purchased separately to give a more refined look. (Traditional Collar MUST be used in conjunction with the 1 1/4" Cuff.)

|  |  |   |   |   |
|--|--|---|---|---|
|  <p>PO114ASFI<br/>Astor<br/>1 3/8" (3.5 cm) W<br/>2 3/8" (6.0 cm) DIA<br/>\$71.50 pair*</p> |  <p>PO114CHFI<br/>Chaplin<br/>1 3/4" (4.4 cm) W<br/>2" (5.1 cm) DIA<br/>\$71.50 pair*</p> |  <p>PO114CLRFI<br/>Clara<br/>2 1/4" (5.7 cm) W<br/>2 5/8" (6.7 cm) DIA<br/>\$71.50 pair*</p> |  <p>PO114FBFI<br/>Fairbanks<br/>3 1/8" (7.9 cm) W<br/>2" (5.1 cm) DIA<br/>\$71.50 pair*</p> |  <p>PO114PIFICU<br/>Pickford with 1 1/4" Cuff<br/>RESIN AND METAL<br/>3" (7.6 cm) W<br/>1 7/8" (4.8 cm) DIA<br/>\$99.00 pair*</p> <p><i>Note: remember that the 1 1/4" Cuff covers 5/8" (1.6 cm) of the pole or track. Finished pole length may need to be increased accordingly.</i></p> |
|--|--|---|---|---|

|   |
|---|
|  <p>PO114TUF1<br/>Turner<br/>2 1/4" (5.7 cm) W<br/>2 3/4" (7.0 cm) DIA<br/>\$71.50 pair*</p> |
|---|

\*Sold in pairs only.

## Portfolio 1 1/4"

Note: Only bases and 1 1/4" metal poles available in any Portfolio finish.



**1 1/4" Pearl Jewel Resin Finials** are available in 3 Pearl colors: cream, grey, and white. Base available in any Portfolio finish. 1 1/4" Pearl Jewel Finials fit the 1 1/4" pole.

|   |  |   |
|---|--|---|
|                          |                         |                          |
| PO114PEJWFI-CR<br>Cream Pearl Jewel<br>RESIN<br>2 1/4" (5.7 cm) W<br>2 3/8" (6.0 cm) DIA<br>\$71.50 pair* | PO114PEJWFI-GY<br>Grey Pearl Jewel<br>RESIN<br>2 1/4" (5.7 cm) W<br>2 3/8" (6.0 cm) DIA<br>\$71.50 pair* | PO114PEJWFI-WH<br>White Pearl Jewel<br>RESIN<br>2 1/4" (5.7 cm) W<br>2 3/8" (6.0 cm) DIA<br>\$71.50 pair* |

**Must specify** a Portfolio finish for the Base of this finial.

**Note:** Remember that the Finial Base covers 1/4" (0.6 cm) of the pole. Finished pole length may need to be increased accordingly.

**1 1/4" Transitional Pearl Resin Finials** are available in 3 Pearl colors: cream, grey, and white. Cuff available in any Portfolio finish. 1 1/4" Transitional Pearl Finials fit the 1 1/4" pole.

|  |   |  |
|--|---|--|
|                                      |                                     |                                      |
| PO114PEFICU-CR<br>Cream Pearl with 1 1/4" Cuff<br>RESIN AND METAL<br>2 1/4" (5.7 cm) W<br>1 5/8" (4.1 cm) DIA<br>\$60.50 pair* | PO114PEFICU-GY<br>Grey Pearl with 1 1/4" Cuff<br>RESIN AND METAL<br>2 1/4" (5.7 cm) W<br>1 5/8" (4.1 cm) DIA<br>\$60.50 pair* | PO114PEFICU-WH<br>White Pearl with 1 1/4" Cuff<br>RESIN AND METAL<br>2 1/4" (5.7 cm) W<br>1 5/8" (4.1 cm) DIA<br>\$60.50 pair* |

**Must specify** a Portfolio finish for the Cuff on this finial.

**Note:** Remember that the 1 1/4" Cuff covers 5/8" (1.6 cm) of the pole. Finished pole length may need to be increased accordingly.

**1 1/4" Modern Pearl Resin Finials** are available in 3 Pearl colors: cream, grey, and white. 1 1/4" Modern Pearl Finials fit the 1 1/4" metal pole.

|   |  |   |
|---|--|---|
|                |               |                |
| PO114PEFI-CR<br>Cream Pearl<br>RESIN<br>1 1/2" (3.8 cm) W<br>1 5/8" (4.1 cm) DIA<br>\$38.50 pair* | PO114PEFI-GY<br>Grey Pearl<br>RESIN<br>1 1/2" (3.8 cm) W<br>1 5/8" (4.1 cm) DIA<br>\$38.50 pair* | PO114PEFI-WH<br>White Pearl<br>RESIN<br>1 1/2" (3.8 cm) W<br>1 5/8" (4.1 cm) DIA<br>\$38.50 pair* |

\*Sold in pairs only.

**1 1/4" Baroque Resin Finials** fit the 1 1/4" pole.

|   |   |   |  |
|---|---|---|--|
|  |  |  |  |
| PO114EBFI   | PO114RAFI   | PO114SBFI   | PO114SOFI  |
| Elisabeth   | Rachel  | Sebastian   | Sophie   |
| 2 1/2" (6.4 cm) W<br>3 1/8" (7.9 cm) DIA  | 4" (10.2 cm) W<br>3" (7.6 cm) DIA   | 2 1/2" (6.4 cm) W<br>2 3/4" (7.0 cm) DIA  | 3 1/2" (8.9 cm) W<br>1 3/4" (4.4 cm) DIA   |
| \$71.50 pair*   | \$93.50 pair*   | \$71.50 pair*   | \$71.50 pair*  |

**1 1/4" Tried & True Resin Finials** fit the 1 1/4" pole.



|   |   |   |  |
|---|---|---|--|
|  |  |  |  |
| PO114AGFI   | PO114BEEC   | PO114ELFI   | PO114RBF1  |
| Agnes   | Beale End Cap   | Eleanor   | Ruby   |
| 2" (5.1 cm) W<br>2 1/2" (6.4 cm) DIA  | 1/2" (1.3 cm) W<br>2" (5.1 cm) DIA  | 2 5/8" (6.7 cm) W<br>3" (7.6 cm) DIA<br>[2 1/8" (5.4 cm) square]                  | 2 1/2" (6.4 cm) W<br>2 1/2" (6.4 cm) DIA   |
| \$60.50 pair*   | \$38.50 pair*   | \$60.50 pair*   | \$60.50 pair*  |

**1 1/4" Mid-Century Modern Resin Finials** fit the 1 1/4" pole.

|   |   |   |  |   |
|---|---|---|--|---|
|  |  |  |  |  |
| PO114DAFI   | PO114FEEC   | PO114ROFI   | PO114SGFI  | PO114SHFI   |
| Dazzle  | Fever End Cap   | Rock  | Shag   | Shimmy  |
| 5 1/4" (13.3 cm) W<br>2 1/2" (6.4 cm) DIA   | 1 1/4" (3.2 cm) W<br>1 5/8" (4.1 cm) DIA  | 3 3/4" (9.5 cm) W<br>2" (5.1 cm) DIA  | 3 3/4" (9.5 cm) W<br>2" (5.1 cm) DIA   | 3" (7.6 cm) W<br>3 1/2" (8.9 cm) DIA  |
| \$93.50 pair*   | \$38.50 pair*   | \$93.50 pair*   | \$71.50 pair*  | \$71.50 pair*   |

\*Sold in pairs only.





1 1/4" Finial Accessories



|  |  |  |
|--|--|--|
| Verify the compatibility of your chosen Finial and Accessory in the chart below. | Add this for a Transitional look.  | Add this turned element for a Traditional look.  |
|  |  <p><b>PO114CUFF</b><br/>1 1/4" Cuff<br/>3/4" (1.9 cm) W<br/>1 1/2" (3.2 cm) DIA</p> <ul style="list-style-type: none"> <li>metal; available in any Portfolio finish</li> <li>covers 5/8" of the pole; finished pole length may need to be increased accordingly</li> </ul> <p><b>\$33.00 pair*</b></p> |  <p><b>POTRADCO</b><br/>Traditional Collar<br/>5/8" (1.6 cm) W<br/>1 1/8" (2.9 cm) DIA</p> <ul style="list-style-type: none"> <li>metal; available in any Portfolio finish</li> <li>must be used with the 1 1/4" Cuff</li> <li>installs between the Finial and 1 1/4" Cuff</li> </ul> <p><b>\$33.00 pair*</b></p> |
| 1 1/4" Transitional Metal Finials  | (included)   | •  |
| 1 1/4" Glamour Resin Finials   | •  | must use with 1 1/4" Cuff, order separately  |

\*Sold in pairs only.

**1 1/4" Brackets** fit the 1 1/4" pole.



Note: Return indicates distance from wall to center of pole. Projection indicates distance from wall to back of pole.

|  |  |   |  |
|--|--|---|--|
|  <p><b>PO114MCMBK</b><br/>1 1/4" Metal Ceiling Mount</p> <p>2" (5.1 cm) W x<br/>2 3/4" (7.0 cm) H x<br/>2" (5.1 cm) D;</p> <hr/> <p>Base: 2" (5.1 cm) DIA<br/>Cradle: 1" (2.5 cm) W x<br/>1 7/8" (4.8 cm) OD x<br/>1 1/2" (3.8 cm) ID</p> <hr/> <p>Drop (distance from ceiling to bottom of pole): 2 5/8" (6.7 cm)</p> <p><b>\$44.00 ea</b></p> |  <p><b>PO114MIBK</b><br/>1 1/4" Metal Inside Mount</p> <p>1" (2.5 cm) W x<br/>1 1/4" (3.2 cm) H x<br/>2 5/8" (5.4 cm) D</p> <p><b>\$71.50 pair*</b></p> | <p><b>Note:</b> Pair includes right and left (set screw located in back when installed)</p>  <p><b>PO114GRSBK</b><br/>Gregory Single*</p> <p>METAL<br/>3/4" (1.9 cm) W x<br/>3 3/4" (9.5 cm) H x<br/>4 1/8" (10.5 cm) D;</p> <hr/> <p>3 1/2" (8.9 cm) RET,<br/>2 7/8" (7.3 cm) PROJ</p> <p><b>\$38.50 ea</b></p> | <p><b>Bypass Support Brackets</b></p>  <p><b>PO114GRDBK</b><br/>Gregory Double*</p> <p>METAL<br/>3/4" (1.9 cm) W x<br/>3 3/4" (9.5 cm) H x<br/>6 5/8" (16.8 cm) D;</p> <hr/> <p>6" (15.2 cm) FRONT RET,<br/>3" (7.6 cm) BACK RET;</p> <hr/> <p>5 5/8" (13.7 cm) FRONT PROJ,<br/>2 5/8" (6.0 cm) BACK PROJ</p> <p>Both Cradles hold 1" pole</p> <p><b>\$44.00 ea</b></p> <p><b>*CAUTION:</b> Gregory Brackets do not have full cradles. Self-threading screw installs through bottom of cradle and into 1 1/4" pole to secure it. Winston Brackets must be installed at each end to secure 1 1/4" pole.</p> <p>• Use with Medium C Ring.</p> |
|--|--|---|--|

|  |   |   |
|--|---|---|
|  <p><b>PO114WSSBK</b><br/>Winston 3" Single</p> <p>METAL<br/>3/4" (1.9 cm) W x<br/>3 3/4" (9.5 cm) H x<br/>4 3/8" (11.1 cm) D;</p> <hr/> <p>3 1/2" (8.9 cm) RET,<br/>2 7/8" (7.3 cm) PROJ</p> <p><b>\$44.00 ea</b></p> |  <p><b>PO114WSS6BK</b><br/>Winston 6" Single</p> <p>METAL<br/>3/4" (1.9 cm) W x<br/>3 3/4" (9.5 cm) H x<br/>6 3/4" (17.1 cm) D;</p> <hr/> <p>6" (15.2 cm) RET,<br/>5 5/8" (13.7 cm) PROJ</p> <p><b>\$49.50 ea</b></p> |  <p><b>PO114WSDBK</b><br/>Winston 6" Double</p> <p>METAL<br/>3/4" (1.9 cm) W x<br/>3 3/4" (9.5 cm) H x<br/>7" (17.8 cm) D;</p> <hr/> <p>6" (15.2 cm) FRONT RET,<br/>3" (7.6 cm) BACK RET;</p> <hr/> <p>5 5/8" (13.7 cm) FRONT PROJ,<br/>2 5/8" (6.0 cm) BACK PROJ</p> <p>Both Cradles hold 1 1/4" pole</p> <p><b>\$49.50 ea</b></p> |
|--|---|---|

**1 1/4" Rings** fit the 1 1/4" pole.

Note: Ring drop indicates distance from bottom of pole to bottom of ring. A ring's drop changes on different diameter poles.

|   |  |  |
|---|--|--|
|  <p><b>PO114MARI</b><br/>Maddox Ring</p> <p>METAL<br/>3/16" (0.5 cm) W x<br/>2" (5.1 cm) ID x<br/>2 3/8" (6.0 cm) OD<br/>1" (2.5) DROP</p> <p><b>\$7.70 ea</b></p> |  <p><b>PO114MCRI</b><br/>Medium C Ring</p> <p>METAL<br/>3/16" (0.5 cm) W x<br/>2" (5.1 cm) ID x<br/>2 3/8" (6.0 cm) OD<br/>1" (2.5) DROP</p> <p>• use this bypass ring with Gregory Bypass Support Brackets</p> <p><b>\$6.60 ea</b></p> |  <p><b>PO114SWRI</b><br/>Swing Ring</p> <p>METAL<br/>3/16" (0.5 cm) W x<br/>1 1/2" (3.8 cm) ID x<br/>2" (5.1 cm) OD<br/>1/2" (1.3) DROP</p> <p><b>\$6.60 ea</b></p> |
|---|--|--|

\*Sold in pairs only.

**1 1/4" Smooth Metal Poles**

Note: All orders with poles and/or traverse track will incur a \$10.00 packaging fee per order.

|            |            |             |             |             |             |             |             |
|------------|------------|-------------|-------------|-------------|-------------|-------------|-------------|
| PO114SM02  | PO114SM04  | PO114SM06   | PO114SM08   | PO114SM10   | PO114SM12   | PO114SM14   | PO114SM16   |
| 2'         | 4'         | 6'          | 8'          | 10'         | 12'         | 14'         | 16'         |
| \$39.60 ea | \$79.20 ea | \$118.80 ea | \$158.40 ea | \$198.00 ea | \$237.60 ea | \$277.20 ea | \$316.80 ea |

**1 1/4" Accessories**

Note: Hinged Resin Elbow and 41" Metal Wand available in any Portfolio finish.



|   |   |   |   |
|---|---|---|---|
|                  |  |  |  |
| PO114REL  | POAC36WAND  | POAC48WAND  | POME41WAND  |
| 1 1/4" Hinged Resin Elbow   | 36" Clear Acrylic Wand  | 48" Clear Acrylic Wand  | 41" Metal Wand  |
| 1 1/4" (3.7 cm) DIA x<br>3/4" (9.5 cm)<br>TOTAL LENGTH,<br>1 7/8" (4.8 cm) each side<br>when bent | ACRYLIC, CLEAR ONLY<br>1/2" (1.3 cm) DIA x<br>36" (91.4 cm) LENGTH                | ACRYLIC, CLEAR ONLY<br>1/2" (1.3 cm) DIA x<br>48" (121.9 cm) LENGTH               | 5/8" (1.6 cm) DIA x<br>41" (104.1 cm) LENGTH                                      |
| \$38.50 ea  | \$44.00 ea  | \$49.50 ea  | \$44.00 ea  |

\*Sold in pairs only.



**1<sup>3</sup>/<sub>8</sub>" Tried & True Resin Finials** fit the 1<sup>3</sup>/<sub>8</sub>" smooth or fluted wood poles.

|  |  |   |  |   |   |
|--|--|---|--|---|---|
|       |   |  |  |  |  |
| PO138AUEC<br>Aubrie End Cap<br>3/4" (1.9 cm) W<br>2 1/4" (5.7 cm) DIA<br>\$38.50 pair* | PO138BRFI<br>Bradford<br>3 3/4" (8.3 cm) W<br>2 1/4" (5.7 cm) DIA<br>\$93.50 pair* | PO138BLFI<br>Brielle<br>4" (10.2 cm) W<br>3" (7.6 cm) DIA<br>\$93.50 pair*        | PO138DPFI<br>Daphne<br>3 1/4" (8.3 cm) W<br>2 1/2" (4.4 cm) DIA<br>\$93.50 pair*   | PO138EAFI<br>Easton<br>2 3/8" (6.0 cm) W<br>3 1/2" (8.9 cm) DIA<br>\$93.50 pair*    | PO138ESEC<br>Essex End Cap<br>3/4" (1.9 cm) W<br>2" (5.1 cm) DIA<br>\$38.50 pair*   |

|   |   |   |  |   |   |
|---|---|---|--|---|---|
|                              |  |  |  |  |  |
| PO138EVFI<br>Everett<br>2 5/8" (7.3 cm) W<br>3 3/8" (8.6 cm) DIA<br>[2 1/2" (6.4 cm) square]<br>\$71.50 pair* | PO138HAFI<br>Harper<br>3" (7.6 cm) W<br>2 3/4" (7.0 cm) DIA<br>\$93.50 pair*      | PO138JLFI<br>Jolette<br>1 5/8" (4.1 cm) W<br>2 1/4" (5.7 cm) DIA<br>\$71.50 pair* | PO138JUFI<br>June<br>2 3/4" (7.0 cm) W<br>2 3/4" (7.0 cm) DIA<br>\$93.50 pair*     | PO138LAFI<br>Lane<br>3 1/2" (8.9 cm) W<br>3 5/8" (9.2 cm) DIA<br>\$93.50 pair*      | PO138LEFI<br>Leo<br>3 5/8" (9.2 cm) W<br>2 3/4" (7.0 cm) DIA<br>\$71.50 pair*       |





|  |   |  |   |  |  |
|--|---|--|---|--|--|
|  |                 |   |  |  |                            |
| PO138LIFI<br>Lillian<br>4" (10.2 cm) W<br>3 3/8" (8.6 cm) DIA<br>\$93.50 pair*     | PO138LIFIGL<br>Lillian - Mercury Glass<br>4" (10.2 cm) W<br>3 1/2" (8.9 cm) DIA<br>\$137.50 pair* | PO138LOEC<br>Lowell End Cap<br>1" (2.5 cm) W<br>1 3/4" (4.4 cm) DIA<br>\$38.50 pair* | PO138LYFI<br>Lyla<br>2 5/8" (6.7 cm) W<br>2 5/8" (6.7 cm) DIA<br>\$71.50 pair*      | PO138MAFI<br>Mae<br>3 1/4" (8.3 cm) W<br>2 3/4" (7.0 cm) DIA<br>\$93.50 pair*        | PO138ROFI<br>Rose - Crystal<br>RESIN AND CRYSTAL<br>2 3/4" (7.0 cm) W<br>2 3/4" (7.0 cm) DIA<br>\$192.50 pair* |

**1<sup>3</sup>/<sub>8</sub>" Jewel Resin Finials** fit the 1<sup>3</sup>/<sub>8</sub>" smooth or fluted wood poles.

|   |   |  |   |  |  |
|---|---|--|---|--|--|
|      |    |       |           |       |     |
| PO138ASJWFI<br>Astor Jewel<br>2 5/8" (6.7 cm) W<br>2 3/8" (6.0 cm) DIA<br>\$93.50 pair* | PO138CHJWFI<br>Chaplin Jewel<br>3" (7.6 cm) W<br>2 1/8" (5.4 cm) DIA<br>\$93.50 pair* | PO138CLRJWFI<br>Clara Jewel<br>3 1/2" (8.9 cm) W<br>2 5/8" (6.7 cm) DIA<br>\$93.50 pair* | PO138FBJWFI<br>Fairbanks Jewel<br>4 9/16" (11.1 cm) W<br>2 1/8" (5.4 cm) DIA<br>\$93.50 pair* | PO138PIJWFI<br>Pickford Jewel<br>3 1/2" (8.9 cm) W<br>2 1/8" (5.4 cm) DIA<br>\$93.50 pair* | PO138TUJWFI<br>Turner Jewel<br>3 1/2" (8.9 cm) W<br>2 3/4" (7.0 cm) DIA<br>\$93.50 pair* |

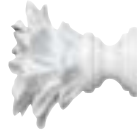
\*Sold in pairs only.

1<sup>3</sup>/<sub>8</sub>" Traditional Resin Finials fit the 1<sup>3</sup>/<sub>8</sub>" smooth or fluted wood poles.

|  |   |  |   |  |
|--|---|--|---|--|
|                                |    |                               |    |   |
| <p>PO138AMFI<br/>Amboise<br/>5<sup>1</sup>/<sub>4</sub>" (13.3 cm) W<br/>3" (7.6 cm) DIA<br/>\$93.50 pair*</p> | <p>PO138AVFI<br/>Avon<br/>3<sup>3</sup>/<sub>8</sub>" (9.2 cm) W<br/>3<sup>3</sup>/<sub>4</sub>" (9.5 cm) DIA<br/>\$93.50 pair*</p> | <p>PO138GAFI<br/>Gabiella<br/>3<sup>3</sup>/<sub>4</sub>" (9.5 cm) W<br/>3" (7.6 cm) DIA<br/>\$93.50 pair*</p> | <p>PO138GSFI<br/>Gaston<br/>3<sup>1</sup>/<sub>2</sub>" (8.9 cm) W<br/>3<sup>3</sup>/<sub>8</sub>" (8.6 cm) DIA<br/>\$93.50 pair*</p> | <p>PO138JOFI<br/>Joan of Arc<br/>3<sup>1</sup>/<sub>2</sub>" (8.9 cm) W<br/>3<sup>1</sup>/<sub>2</sub>" (8.9 cm) DIA<br/>\$93.50 pair*</p> |





|  |  |  |  |
|--|--|--|--|
|   |   |                             |   |
| <p>PO138MRFI<br/>Marcel<br/>4<sup>3</sup>/<sub>4</sub>" (12.1 cm) W<br/>3<sup>7</sup>/<sub>8</sub>" (9.8 cm) DIA<br/>\$93.50 pair*</p> | <p>PO138PIFI<br/>Pierre<br/>4<sup>1</sup>/<sub>2</sub>" (11.4 cm) W<br/>3<sup>3</sup>/<sub>8</sub>" (8.6 cm) DIA<br/>\$93.50 pair*</p> | <p>PO138SEFI<br/>Severn<br/>3<sup>1</sup>/<sub>2</sub>" (8.9 cm) W<br/>3" (7.6 cm) DIA<br/>\$93.50 pair*</p> | <p>PO138SCEC<br/>Small Carved<br/>End Cap<br/>7<sup>8</sup>/<sub>16</sub>" (2.2 cm) W<br/>1<sup>7</sup>/<sub>8</sub>" (4.8 cm) DIA<br/>\$38.50 pair*</p> |





\*Sold in pairs only.

**1<sup>3</sup>/<sub>8</sub>" Brackets** fit the 1<sup>3</sup>/<sub>8</sub>" smooth or fluted wood poles.

Note: Return indicates distance from wall to center of pole. Projection indicates distance from wall to back of pole.

|  |  |   |  |  |
|--|--|---|--|--|
|  <p><b>PO138MCMBK</b><br/>1<sup>3</sup>/<sub>8</sub>" Metal Ceiling Mount</p> <p>2" (5.1 cm) W x<br/>2<sup>3</sup>/<sub>4</sub>" (7.0 cm) H x<br/>2" (5.1 cm) D;</p> <p>Base: 2" (5.1 cm) DIA<br/>Cradle: 1" (2.5 cm) W x<br/>1<sup>7</sup>/<sub>8</sub>" (4.8 cm) OD x<br/>1<sup>1</sup>/<sub>2</sub>" (3.8 cm) ID</p> <p>Drop (distance from ceiling to bottom of pole): 2<sup>5</sup>/<sub>8</sub>" (6.7 cm)</p> <p>\$44.00 ea</p> |  <p><b>PO138MIBK</b><br/>1<sup>3</sup>/<sub>8</sub>" Metal Inside Mount</p> <p>1" (2.5 cm) W x<br/>1<sup>1</sup>/<sub>4</sub>" (3.2 cm) H x<br/>2<sup>1</sup>/<sub>8</sub>" (5.4 cm) D</p> <p>\$79.20 pair*</p> | <p><b>Note:</b> Pair includes right and left (set screw located in back when installed)</p>  <p><b>PO138WOCBK</b><br/>1<sup>3</sup>/<sub>8</sub>" Wood Ceiling Mount</p> <p>3/4" (1.9 cm) W x<br/>3<sup>1</sup>/<sub>4</sub>" (8.3 cm) H x<br/>6<sup>1</sup>/<sub>8</sub>" (15.6 cm) D;</p> <p>Drop (distance from ceiling to bottom of pole): 2<sup>5</sup>/<sub>8</sub>" (6.0 cm)</p> <p>\$55.00 ea</p> |  <p><b>PO138WOIBK</b><br/>1<sup>3</sup>/<sub>8</sub>" Wood Inside Mount</p> <p>1" (2.5 cm) W x<br/>2<sup>3</sup>/<sub>8</sub>" (6.0 cm) H x<br/>2<sup>3</sup>/<sub>8</sub>" (6.0 cm) D</p> <p>\$55.00 pair*</p> |  <p><b>PO138EDSBK</b><br/>Edison Single</p> <p>RESIN<br/>1" (2.5 cm) W x<br/>4" (10.2 cm) H x<br/>4<sup>1</sup>/<sub>4</sub>" (12.1 cm) D;<br/>3<sup>3</sup>/<sub>4</sub>" (9.5 cm) RET;<br/>3" (7.6 cm) PROJ</p> <p>\$44.00 ea</p> |
|--|--|---|--|--|

|   |   |  |   |   |  |
|---|---|--|---|---|--|
| <b>Bypass Support Brackets</b>  |   |  |   |   |  |
|  <p><b>PO138EDDBK</b><br/>Edison Double</p> <p>RESIN<br/>1" (2.5 cm) W x<br/>4" (10.2 cm) H x<br/>7<sup>3</sup>/<sub>4</sub>" (19.7 cm) D;<br/>6<sup>3</sup>/<sub>4</sub>" (17.1 cm) FRONT RET,<br/>3<sup>3</sup>/<sub>4</sub>" (9.5 cm) BACK RET;<br/>6" (15.2 cm) FRONT PROJ,<br/>3" (7.6 cm) BACK PROJ<br/>Both Cradles hold 1<sup>3</sup>/<sub>8</sub>" pole</p> <p>\$55.00 ea</p> |  <p><b>PO138GRBK</b><br/>Grace</p> <p>RESIN<br/>1<sup>3</sup>/<sub>8</sub>" (3.5 cm) W x<br/>7<sup>3</sup>/<sub>4</sub>" (19.7 cm) H x<br/>5" (12.7 cm) D;<br/>3<sup>5</sup>/<sub>8</sub>" (9.2 cm) RET,<br/>2<sup>7</sup>/<sub>8</sub>" (7.3 cm) PROJ</p> <p>\$44.00 ea</p> |  <p><b>PO138GRSBK</b><br/>Gregory Single •</p> <p>METAL<br/>3/4" (1.9 cm) W x<br/>3<sup>3</sup>/<sub>4</sub>" (9.5 cm) H x<br/>4<sup>1</sup>/<sub>8</sub>" (10.5 cm) D;<br/>3<sup>1</sup>/<sub>2</sub>" (8.9 cm) RET,<br/>2<sup>7</sup>/<sub>8</sub>" (7.3 cm) PROJ</p> <p>\$38.50 ea</p> |  <p><b>PO138GRDBK</b><br/>Gregory Double •</p> <p>METAL<br/>3/4" (1.9 cm) W x<br/>3<sup>3</sup>/<sub>4</sub>" (9.5 cm) H x<br/>6<sup>5</sup>/<sub>8</sub>" (16.8 cm) D;<br/>6" (15.2 cm) FRONT RET,<br/>3" (7.6 cm) BACK RET;<br/>5<sup>3</sup>/<sub>8</sub>" (13.7 cm) FRONT PROJ,<br/>2<sup>5</sup>/<sub>8</sub>" (6.0 cm) BACK PROJ<br/>Both Cradles hold 1<sup>3</sup>/<sub>8</sub>" pole</p> <p>\$44.00 ea</p> |  <p><b>PO138SHBK</b><br/>Shelburne</p> <p>RESIN<br/>1<sup>1</sup>/<sub>4</sub>" (3.2 cm) W x<br/>5<sup>1</sup>/<sub>4</sub>" (13.3 cm) H x<br/>5<sup>1</sup>/<sub>2</sub>" (14.0 cm) D;<br/>3<sup>3</sup>/<sub>4</sub>" (9.5 cm) RET,<br/>3" (7.6 cm) PROJ</p> <p>\$38.50 ea</p> | <p>• <b>CAUTION:</b> Gregory Brackets do not have full cradles. Self-threading screw installs through bottom of cradle and into 1<sup>3</sup>/<sub>8</sub>" pole to secure it. Winston Brackets must be installed at each end to secure 1<sup>3</sup>/<sub>8</sub>" pole.</p> <p>• Use with Medium C Ring.</p> |

|  |  |   |  |  |   |
|--|--|---|--|--|---|
|  <p><b>PO138WISBK</b><br/>William 3" Single</p> <p>RESIN<br/>1" (2.5 cm) W x<br/>3<sup>1</sup>/<sub>2</sub>" (8.9 cm) H x<br/>5" (12.7 cm) D;<br/>3<sup>3</sup>/<sub>4</sub>" (9.5 cm) RET,<br/>3" (7.6 cm) PROJ</p> <p>\$44.00 ea</p> |  <p><b>PO138WIS6BK</b><br/>William 6" Single</p> <p>RESIN<br/>1" (2.5 cm) W x<br/>3<sup>1</sup>/<sub>2</sub>" (8.9 cm) H x<br/>7<sup>7</sup>/<sub>8</sub>" (20.0 cm) D;<br/>6<sup>3</sup>/<sub>4</sub>" (17.1 cm) RET,<br/>6" (15.2 cm) PROJ</p> <p>\$55.00 ea</p> |  <p><b>PO138WIDBK</b><br/>William 6" Double</p> <p>RESIN<br/>1" (2.5 cm) W x<br/>3<sup>5</sup>/<sub>8</sub>" (8.6 cm) H x<br/>7<sup>7</sup>/<sub>8</sub>" (20.0 cm) D;<br/>6<sup>3</sup>/<sub>4</sub>" (17.1 cm) FRONT RET,<br/>3<sup>1</sup>/<sub>4</sub>" (8.3 cm) BACK RET;<br/>6" (15.2 cm) FRONT PROJ,<br/>2<sup>1</sup>/<sub>2</sub>" (6.4 cm) BACK PROJ<br/>Both Cradles hold 1<sup>3</sup>/<sub>8</sub>" pole</p> <p>\$55.00 ea</p> |  <p><b>PO138WSSBK</b><br/>Winston 3" Single</p> <p>METAL<br/>3/4" (1.9 cm) W x<br/>3<sup>3</sup>/<sub>4</sub>" (9.5 cm) H x<br/>4<sup>9</sup>/<sub>8</sub>" (11.1 cm) D;<br/>3<sup>1</sup>/<sub>2</sub>" (8.9 cm) RET,<br/>2<sup>7</sup>/<sub>8</sub>" (7.3 cm) PROJ</p> <p>\$44.00 ea</p> |  <p><b>PO138WSS6BK</b><br/>Winston 6" Single</p> <p>METAL<br/>3/4" (1.9 cm) W x<br/>3<sup>3</sup>/<sub>4</sub>" (9.5 cm) H x<br/>6<sup>3</sup>/<sub>4</sub>" (17.1 cm) D;<br/>6" (15.2 cm) RET,<br/>5<sup>3</sup>/<sub>8</sub>" (13.7 cm) PROJ</p> <p>\$49.50 ea</p> |  <p><b>PO138WSDBK</b><br/>Winston 6" Double</p> <p>METAL<br/>3/4" (1.9 cm) W x<br/>3<sup>3</sup>/<sub>4</sub>" (9.5 cm) H x<br/>7" (17.8 cm) D;<br/>6" (15.2 cm) FRONT RET,<br/>3" (7.6 cm) BACK RET;<br/>5<sup>3</sup>/<sub>8</sub>" (13.7 cm) FRONT PROJ,<br/>2<sup>5</sup>/<sub>8</sub>" (6.0 cm) BACK PROJ<br/>Both Cradles hold 1<sup>3</sup>/<sub>8</sub>" pole</p> <p>\$49.50 ea</p> |
|--|--|---|--|--|---|

\*Sold in pairs only.

**1 3/8" Wood Poles**

Note: All orders with poles and/or traverse track will incur a \$10.00 packaging fee per order.

|                                      |                                      |                                       |                                       |  |  |
|--------------------------------------|--------------------------------------|---------------------------------------|---------------------------------------|--|--|
| PO138FL02<br>2' Fluted<br>\$39.60 ea | PO138FL04<br>4' Fluted<br>\$79.20 ea | PO138FL06<br>6' Fluted<br>\$118.80 ea | PO138FL08<br>8' Fluted<br>\$158.40 ea | PO138FL10<br>10' Fluted<br>\$198.00 ea | PO138FL12<br>12' Fluted<br>\$237.60 ea |
|--------------------------------------|--------------------------------------|---------------------------------------|---------------------------------------|--|--|

|                                      |                                      |                                       |                                       |  |  |
|--------------------------------------|--------------------------------------|---------------------------------------|---------------------------------------|--|--|
| PO138SM02<br>2' Smooth<br>\$39.60 ea | PO138SM04<br>4' Smooth<br>\$79.20 ea | PO138SM06<br>6' Smooth<br>\$118.80 ea | PO138SM08<br>8' Smooth<br>\$158.40 ea | PO138SM10<br>10' Smooth<br>\$198.00 ea | PO138SM12<br>12' Smooth<br>\$237.60 ea |
|--------------------------------------|--------------------------------------|---------------------------------------|---------------------------------------|--|--|





**1 3/8" Rings** fit the 1 3/8" smooth or fluted wood poles.

Note: Ring drop indicates distance from bottom of pole to bottom of ring. A ring's drop changes on different diameter poles.

|  |   |  |  |  |  |
|--|---|--|--|--|--|
|   |    |   |   |   | <p>• Use this bypass ring with Gregory Bypass Support Brackets</p> |
| PO138WRI<br>1 3/8" Wood Ring<br>WOOD<br>1/2" (1.3 cm) W<br>1 3/4" (4.4 cm) ID x<br>2 5/8" (6.7 cm) OD<br>3/4" (1.9 cm) DROP<br>\$7.70 ea | PO138MRI<br>1 3/8" Metal Ring<br>METAL<br>3/16" (0.5 cm) W<br>1 3/4" (4.4 cm) ID x<br>2 1/4" (5.7 cm) OD<br>1/2" (1.3 cm) DROP<br>\$7.70 ea | PO138LERI<br>Leaf Ring<br>RESIN<br>5/8" (1.6 cm) W<br>1 7/8" (4.8 cm) ID x<br>3 1/8" (7.9 cm) OD<br>1 1/4" (3.2 cm) DROP<br>\$16.50 ea | PO138MARI<br>Maddox Ring<br>METAL<br>3/16" (0.5 cm) W<br>2" (5.1 cm) ID x<br>2 3/8" (6.0 cm) OD<br>3/4" (1.9 cm) DROP<br>\$7.70 ea | PO138MCRI<br>Medium C Ring<br>METAL<br>3/16" (0.5 cm) W<br>2" (5.1 cm) ID x<br>2 3/8" (6.0 cm) OD<br>3/4" (1.9 cm) DROP<br>\$6.60 ea |  |





**1 3/8" Accessories**

Note: Hinged Resin Elbow and 41" Metal Wand available in any Portfolio finish.







|  |  |   |   |
|--|--|---|---|
|   | <i>Note: New Elbow has smaller diameter to allow 1 3/8" rings to get closer to the corner.</i>                           |   |   |
| PO138REL<br>1 3/8" Hinged Resin Elbow<br>1 5/8" (4.1 cm) DIA x<br>3 7/8" (9.8 cm)<br>TOTAL LENGTH,<br>1 15/16" (4.9 cm) each<br>side when bent<br>\$44.00 ea |          |           |  |
|  | POAC36WAND<br>36" Clear Acrylic Wand<br>ACRYLIC, CLEAR ONLY<br>1/2" (1.3 cm) DIA x<br>36" (91.4 cm) LENGTH<br>\$44.00 ea | POAC48WAND<br>48" Clear Acrylic Wand<br>ACRYLIC, CLEAR ONLY<br>1/2" (1.3 cm) DIA x<br>48" (121.9 cm) LENGTH<br>\$49.50 ea | POME41WAND<br>41" Metal Wand<br>5/8" (1.6 cm) DIA x<br>41" (104.1 cm) LENGTH<br>\$44.00 ea              |

\*Sold in pairs only.

**2" Glamour Resin Finials** fit 2" smooth or fluted wood poles.

|  |   |   |  |   |
|--|---|---|--|---|
|                     |  |  |  |  |
| PO200EMFI<br>Emerald<br>3" (7.6 cm) W<br>3¾" (9.5 cm) DIA<br>[2¾" (7.0 cm) square]<br>\$104.50 pair* | PO200EVFI<br>Eva<br>5½" (14.0 cm) W<br>3¾" (9.5 cm) DIA<br>\$104.50 pair*         | PO200LAFI<br>Lainey<br>3⅞" (9.8 cm) W<br>3½" (8.9 cm) DIA<br>\$104.50 pair*       | PO200MNFI<br>Marin<br>4" (10.2 cm) W<br>4⅞" (10.5 cm) DIA<br>\$104.50 pair*        | PO200SAFI<br>Sapphire<br>3¼" (8.3 cm) W<br>3⅞" (8.6 cm) DIA<br>\$104.50 pair*       |

**2" Tried & True Resin Finials** fit 2" smooth or fluted wood poles.

|   |   |   |   |   |   |
|---|---|---|---|---|---|
|  |  |  |    |  |  |
| PO200ADFI<br>Andre<br>3⅞" (9.8 cm) W<br>3⅞" (8.6 cm) DIA<br>\$104.50 pair*        | PO200AEFI<br>Anneliese<br>5" (12.7 cm) W<br>4½" (11.4 cm) DIA<br>\$104.50 pair*   | PO200CAFI<br>Cayley<br>3⅞" (9.2 cm) W<br>4" (10.2 cm) DIA<br>\$104.50 pair*       | PO200COEC<br>Cosette End Cap<br>1⅞" (4.8 cm) W<br>2¾" (7.0 cm) DIA<br>\$49.50 pair* | PO200EIFI<br>Eirwen<br>4½" (11.4 cm) W<br>3¾" (9.5 cm) DIA<br>\$104.50 pair*        | PO200IMFI<br>Imogene<br>4¾" (12.1 cm) W<br>4½" (11.4 cm) DIA<br>\$104.50 pair*      |

|   |   |   |  |   |
|---|---|---|--|---|
|  |  |  |  |  |
| PO200MDFI<br>Madelaide<br>5¾" (14.6 cm) W<br>3¾" (9.5 cm) DIA<br>\$104.50 pair*     | PO200MAEC<br>Margot End Cap<br>¾" (1.9 cm) W<br>3" (7.6 cm) DIA<br>\$49.50 pair*    | PO200MAFI<br>Mariele<br>4¼" (10.8 cm) W<br>3½" (8.9 cm) DIA<br>\$104.50 pair*       | PO200NIFI<br>Nicholas<br>4½" (11.4 cm) W<br>3⅞" (8.6 cm) DIA<br>\$104.50 pair*       | PO200OPFI<br>Ophelia<br>5¼" (13.3 cm) W<br>3⅞" (7.9 cm) DIA<br>\$104.50 pair*         |

\*Sold in pairs only.

**2" Brackets** fit 2" smooth or fluted wood poles.

Note: Return indicates distance from wall to center of pole. Projection indicates distance from wall to back of pole.

|   |  |   |   |
|---|--|---|---|
|  <p><b>PO200MCMBK</b><br/>2" Metal Ceiling Mount</p> <p>1" (2.5 cm) W x<br/>3<sup>3</sup>/<sub>4</sub>" (9.5 cm) H x<br/>3<sup>1</sup>/<sub>4</sub>" (8.3 cm) D;</p> <hr/> <p>Base: 1" (2.5 cm) W x<br/>3<sup>1</sup>/<sub>4</sub>" (8.3 cm) D;</p> <hr/> <p>Cradle: 1" (2.5 cm) W x<br/>2<sup>7</sup>/<sub>16</sub>" (6.3 cm) ID x<br/>2<sup>3</sup>/<sub>4</sub>" (7.0 cm) OD</p> <hr/> <p>Drop (distance from ceiling to bottom of pole): 3<sup>5</sup>/<sub>8</sub>" (9.2 cm)</p> <p><b>\$49.50 ea</b></p> |  <p><b>PO200MIBK</b><br/>2" Metal Inside Mount</p> <p>1" (2.5 cm) W x<br/>1<sup>5</sup>/<sub>8</sub>" (4.1 cm) H x<br/>2<sup>7</sup>/<sub>8</sub>" (7.3 cm) D</p> <p><b>\$93.50 pair*</b></p> | <p><i>Note: Pair includes right and left (set screw located in back when installed)</i></p>  <p><b>PO200WOCBK</b><br/>2" Wood Ceiling Mount</p> <p>1" (2.5 cm) W x<br/>4<sup>1</sup>/<sub>8</sub>" (10.5 cm) H x<br/>8<sup>3</sup>/<sub>8</sub>" (21.3 cm) D;</p> <hr/> <p>Drop (distance from ceiling to bottom of pole): 3<sup>3</sup>/<sub>8</sub>" (8.6 cm)</p> <p><b>\$60.50 ea</b></p> |  <p><b>PO200WOIBK</b><br/>2" Wood Inside Mount</p> <p>1" (2.5 cm) W x<br/>3<sup>1</sup>/<sub>8</sub>" (7.9 cm) H x<br/>4<sup>7</sup>/<sub>8</sub>" (12.4 cm) D</p> <p><b>\$88.00 pair*</b></p> |
|---|--|---|---|

|   |   |
|---|---|
|  <p><b>PO200CMSBK</b><br/>Camille 3" Single</p> <p>METAL<br/>3<sup>1</sup>/<sub>4</sub>" (8.3 cm) DIA BASE x<br/>5<sup>5</sup>/<sub>8</sub>" (14.3 cm) D;</p> <hr/> <p>4" (10.2 cm) RET,<br/>3" (7.6 cm) PROJ</p> <p><b>\$66.00 ea</b></p> |  <p><b>PO200CMDBK</b><br/>Camille 6" Double</p> <p>METAL<br/>3<sup>1</sup>/<sub>4</sub>" (8.3 cm) DIA BASE x<br/>8<sup>3</sup>/<sub>4</sub>" (22.2 cm) D;</p> <hr/> <p>7" (17.8 cm) FRONT RET,<br/>3<sup>1</sup>/<sub>2</sub>" (8.9 cm) BACK RET;</p> <hr/> <p>6" (15.2 cm) FRONT PROJ,<br/>3" (7.6 cm) BACK PROJ</p> <p><b>\$88.00 ea</b></p> |
|---|---|

|  |  |   |
|--|--|---|
|  <p><b>PO200HASBK</b><br/>Harlan 3" Single</p> <p>METAL<br/>3<sup>1</sup>/<sub>4</sub>" (1.9 cm) W x<br/>3<sup>3</sup>/<sub>4</sub>" (9.5 cm) H x<br/>5<sup>1</sup>/<sub>2</sub>" (14.0 cm) D;</p> <hr/> <p>4" (10.2 cm) RET,<br/>3" (7.6 cm) PROJ</p> <p><b>\$55.00 ea</b></p> |  <p><b>PO200HAS6BK</b><br/>Harlan 6" Single</p> <p>METAL<br/>3<sup>1</sup>/<sub>4</sub>" (1.9 cm) W x<br/>3<sup>3</sup>/<sub>4</sub>" (9.5 cm) H x<br/>7<sup>1</sup>/<sub>4</sub>" (18.4 cm) D;</p> <hr/> <p>6" (15.2 cm) RET,<br/>5" (12.7 cm) PROJ</p> <p><b>\$60.50 ea</b></p> |  <p><b>PO200HADBK</b><br/>Harlan 6" Double</p> <p>METAL<br/>3<sup>1</sup>/<sub>4</sub>" (1.9 cm) W x<br/>3<sup>3</sup>/<sub>4</sub>" (9.5 cm) H x<br/>7<sup>1</sup>/<sub>4</sub>" (18.4 cm) D;</p> <hr/> <p>6" (15.2 cm) FRONT RET,<br/>2<sup>3</sup>/<sub>8</sub>" (6.0 cm) BACK RET;</p> <hr/> <p>5" (12.7 cm) FRONT PROJ,<br/>1<sup>7</sup>/<sub>8</sub>" (4.8 cm) BACK PROJ</p> <p><b>\$60.50 ea</b></p> |
|--|--|---|

\*Sold in pairs only.

## 2" Wood Poles

Note: All orders with poles and/or traverse track will incur a \$10.00 packaging fee per order.

|                                      |                                       |                                       |                                       |  |  |  |  |
|--------------------------------------|---------------------------------------|---------------------------------------|---------------------------------------|--|--|--|--|
| PO200FL02<br>2' Fluted<br>\$63.80 ea | PO200FL04<br>4' Fluted<br>\$127.60 ea | PO200FL06<br>6' Fluted<br>\$191.40 ea | PO200FL08<br>8' Fluted<br>\$255.20 ea | PO200FL10<br>10' Fluted<br>\$319.00 ea | PO200FL12<br>12' Fluted<br>\$382.80 ea | PO200FL14<br>14' Fluted<br>\$446.60 ea | PO200FL16<br>16' Fluted<br>\$510.40 ea |
|--------------------------------------|---------------------------------------|---------------------------------------|---------------------------------------|--|--|--|--|

|                                      |                                       |                                       |                                       |  |  |  |  |
|--------------------------------------|---------------------------------------|---------------------------------------|---------------------------------------|--|--|--|--|
| PO200SM02<br>2' Smooth<br>\$63.80 ea | PO200SM04<br>4' Smooth<br>\$127.60 ea | PO200SM06<br>6' Smooth<br>\$191.40 ea | PO200SM08<br>8' Smooth<br>\$255.20 ea | PO200SM10<br>10' Smooth<br>\$319.00 ea | PO200SM12<br>12' Smooth<br>\$382.80 ea | PO200SM14<br>14' Smooth<br>\$446.60 ea | PO200SM16<br>16' Smooth<br>\$510.40 ea |
|--------------------------------------|---------------------------------------|---------------------------------------|---------------------------------------|--|--|--|--|





## 2" Rings

fit the 2" smooth or fluted wood poles.  
Note: Ring drop indicates distance from bottom of pole to bottom of ring. A ring's drop changes on different diameter poles.

|  |  |  |   |  |
|--|--|--|---|--|
| <br><b>PO200WRI</b><br>2" Wood Ring<br><br>WOOD<br>1/2" (1.3 cm) W<br>2 1/4" (5.7 cm) ID x<br>3 1/4" (8.3 cm) OD<br>3/4" (1.9 cm) DROP<br><br>\$9.90 ea | <br><b>PO200CHRI</b><br>Christelle Ring<br><br>RESIN<br>1/2" (1.3 cm) W x<br>3 1/4" (8.3 cm) H<br>2 1/2" (6.4 cm) ID x<br>3 3/8" (8.6 cm) OD<br>7/8" (2.2 cm) DROP<br><br>\$9.90 ea | <br><b>PO200DURI</b><br>Duncan Ring<br><br>METAL<br>3/16" (0.5 cm) W<br>2 1/2" (6.4 cm) ID x<br>2 7/8" (7.3 cm) OD<br>3/4" (1.9 cm) DROP<br><br>\$7.70 ea | <br><b>PO200FORI</b><br>Forrest Ring<br><br>METAL<br>3/16" (0.5 cm) W<br>2 3/4" (7.0 cm) ID x<br>3 1/8" (7.9 cm) OD<br>1" (2.5 cm) DROP<br><br>\$7.70 ea | <br><b>PO200IVRI</b><br>Ivanna Ring<br><br>RESIN<br>1/2" (1.3 cm) W x<br>3 1/4" (8.3 cm) H<br>2 1/2" (6.4 cm) ID x<br>3 1/4" (8.3 cm) OD<br>7/8" (2.2 cm) DROP<br><br>\$9.90 ea |
|--|--|--|---|--|

## 2" Accessories

Note: Hinged Resin Elbow and 41" Metal Wand available in any Portfolio finish.

|   |   |   |  |  |
|---|---|---|--|--|
| <br><b>PO200REL</b><br>2" Hinged<br>Resin Elbow<br><br>2 1/8" (5.3 cm) DIA x<br>4 5/8" (11.1 cm)<br>TOTAL LENGTH,<br>2 3/16" (5.6 cm) each side<br>when bent<br><br>\$55.00 ea | <p><i>Note: Elbow has smaller diameter to allow 2" rings to get closer to the corner.</i></p> | <br><b>POAC36WAND</b><br>36" Clear Acrylic<br>Wand<br><br>ACRYLIC, CLEAR ONLY<br>1/2" (1.3 cm) DIA x<br>36" (91.4 cm) LENGTH<br><br>\$44.00 ea | <br><b>POAC48WAND</b><br>48" Clear Acrylic<br>Wand<br><br>ACRYLIC, CLEAR ONLY<br>1/2" (1.3 cm) DIA x<br>48" (121.9 cm) LENGTH<br><br>\$49.50ea | <br><b>POME41WAND</b><br>41" Metal Wand<br><br>5/8" (1.6 cm) DIA x<br>41" (104.1 cm) LENGTH<br><br>\$44.00 ea |
|---|---|---|--|--|





\*Sold in pairs only.



2 1/4" Tried & True Resin Finials fit the 2 1/4" smooth or fluted wood poles.

|   |   |  |  |   |   |
|---|---|--|--|---|---|
|  <p>PO214ADFI<br/>Adelaide<br/>5" (12.7 cm) W<br/>3 1/2" (8.9 cm) DIA<br/>\$115.50 pair*</p> |  <p>PO214ADFIGL<br/>Adelaide - Mercury Glass<br/>5" (12.7 cm) W<br/>3 3/8" (8.6 cm) DIA<br/>\$165.00 pair*</p> |  <p>PO214BEFI<br/>Beatrice<br/>4 1/4" (10.8 cm) W<br/>4" (10.2 cm) DIA<br/>\$137.50 pair*</p> |  <p>PO214BREC<br/>Brinley End Cap<br/>1 1/2" (3.8 cm) W<br/>2 3/4" (7.0 cm) DIA<br/>\$49.50 pair*</p> |  <p>PO214DUEC<br/>Durham End Cap<br/>7/8" (2.2 cm) W<br/>3" (7.6 cm) DIA<br/>\$49.50 pair*</p> |  <p>PO214EDFI<br/>Edward<br/>4 1/4" (10.8 cm) W<br/>3 1/4" (8.3 cm) DIA<br/>\$115.50 pair*</p> |
|---|---|--|--|---|---|

|   |   |   |   |  |  |
|---|---|---|---|--|--|
|  <p>PO214FIFI<br/>Fiona<br/>4" (10.2 cm) W<br/>5 1/4" (13.3 cm) DIA<br/>\$137.50 pair*</p> |  <p>PO214GAEC<br/>Gage End Cap<br/>1" (2.5 cm) W<br/>3" (7.6 cm) DIA<br/>\$49.50 pair*</p> |  <p>PO214HZFI<br/>Hazel - Crystal<br/>RESIN AND CRYSTAL<br/>2 3/4" (7.0 cm) W<br/>3 1/4" (8.3 cm) DIA<br/>\$220.00 pair*</p> |  <p>PO214LCEC<br/>Large Carved End Cap<br/>1" (2.5 cm) W<br/>2 3/4" (7.0 cm) DIA<br/>\$49.50 pair*</p> |  <p>PO214OLFI<br/>Oliver<br/>3 3/4" (9.5 cm) W<br/>3 3/4" (9.5 cm) DIA<br/>\$115.50 pair*</p> |  <p>PO214STFI<br/>Stella<br/>2 1/4" (5.7 cm) W<br/>3 1/4" (8.3 cm) DIA<br/>\$115.50 pair*</p> |
|---|---|---|---|--|--|

2 1/4" Glamour Resin Finials fit the 2 1/4" smooth or fluted wood poles.





|   |   |  |   |  |   |
|---|---|--|---|--|---|
|  <p>PO214BUFI<br/>Beau<br/>4" (10.2 cm) W<br/>3 3/8" (8.6 cm) DIA<br/>\$137.50 pair*</p> |  <p>PO214DAFI<br/>Davies<br/>4 1/8" (10.5 cm) W<br/>3 1/2" (8.9 cm) DIA<br/>\$115.50 pair*</p> |  <p>PO214LOFI<br/>Louise<br/>4 1/4" (10.8 cm) W<br/>4" (10.2 cm) DIA<br/>\$115.50 pair*</p> |  <p>PO214MRFI<br/>Maribel<br/>1 7/8" (4.8 cm) W<br/>3" (7.6 cm) DIA<br/>\$115.50 pair*</p> |  <p>PO214OPFI<br/>Opal<br/>3 1/8" (7.9 cm) W<br/>3 3/4" (9.5 cm) DIA<br/>\$137.50 pair*</p> |  <p>PO214PAFI<br/>Paris<br/>2 5/8" (6.7 cm) W<br/>3 1/2" (8.9 cm) DIA<br/>\$115.50 pair*</p> |
|---|---|--|---|--|---|

|   |   |   |
|---|---|---|
|  <p>PO214QUFI<br/>Quincy<br/>5 3/4" (14.6 cm) W<br/>2 3/4" (7.0 cm) DIA<br/>\$115.50 pair*</p> |  <p>PO214SIFI<br/>Sidney<br/>3 1/4" (8.3 cm) W<br/>4 1/4" (10.8 cm) DIA<br/>[3" Square]<br/>\$115.50 pair*</p> |  <p>PO214VEFI<br/>Versailles<br/>8" (20.3 cm) W<br/>3 1/2" (8.9 cm) H<br/>2 3/4" (7.0 cm) D<br/>\$137.50 pair*</p> |
|---|---|---|

\*Sold in pairs only.



**2 1/4" Traditional Resin Finials** fit the 2 1/4" smooth or fluted wood poles.

|   |  |  |  |   |
|---|--|--|--|---|
|  <p><b>Note:</b> Finial base covers 1/2" (1.3 cm) of pole. Finished pole length may need to be increased accordingly.</p> <p><b>PO214ARFI</b><br/>Artichoke</p> <p>6 3/4" (17.1 cm) W<br/>3 3/4" (9.5 cm) DIA</p> <p><b>\$137.50 pair*</b></p> |  <p><b>PO214BOFI</b><br/>Bordeaux</p> <p>4 3/4" (12.1 cm) W<br/>4 1/8" (10.5 cm) DIA</p> <p><b>\$137.50 pair*</b></p> |  <p><b>PO214CMFI</b><br/>Cambria</p> <p>7 1/4" (18.4 cm) W x<br/>4" (10.2 cm) H x<br/>2 3/4" (7.0 cm) D</p> <p><b>\$115.50 pair*</b></p> |  <p><b>PO214EAFI</b><br/>Ema</p> <p>5 1/4" (13.3 cm) W<br/>3" (7.6 cm) DIA</p> <p><b>\$115.50 pair*</b></p> |  <p><b>PO214GKFI</b><br/>Greek</p> <p>5" (12.7 cm) W<br/>4" (10.2 cm) DIA</p> <p><b>\$115.50 pair*</b></p> |
|---|--|--|--|---|

|   |  |  |   |  |   |
|---|--|--|---|--|---|
|  <p><b>PO214GRFI</b><br/>Greer</p> <p>7 3/8" (18.7 cm) W<br/>4 3/4" (12.1 cm) DIA</p> <p><b>\$137.50 pair*</b></p> |  <p><b>PO214KEFI</b><br/>Kenley</p> <p>5 3/4" (14.6 cm) W<br/>5" (12.7 cm) DIA</p> <p><b>\$137.50 pair*</b></p> |  <p><b>PO214LNFI</b><br/>Landon</p> <p>5 1/2" (14.0 cm) W<br/>4" (10.2 cm) DIA</p> <p><b>\$137.50 pair*</b></p> |  <p><b>PO214LYFI</b><br/>Lyon</p> <p>4 3/4" (12.1 cm) W<br/>4 7/8" (12.4 cm) DIA</p> <p><b>\$137.50 pair*</b></p> |  <p><b>PO214MAFI</b><br/>Marie Antoinette</p> <p>5" (12.7 cm) W<br/>5" (12.7 cm) DIA</p> <p><b>\$137.50 pair*</b></p> |  <p><b>PO214MIFI</b><br/>Michael</p> <p>6 3/4" (17.1 cm) W<br/>4" (10.2 cm) DIA</p> <p><b>\$137.50 pair*</b></p> |
|---|--|--|---|--|---|





|  |   |
|--|---|
|  <p><b>PO214NAFI</b><br/>Natasha</p> <p>4 3/8" (11.1 cm) W<br/>3 3/4" (9.5 cm) DIA</p> <p><b>\$115.50 pair*</b></p> |  <p><b>PO214RYFI</b><br/>Rydal</p> <p>5 3/4" (14.6 cm) W<br/>4 3/8" (11.1 cm) DIA</p> <p><b>\$137.50 pair*</b></p> |
|--|---|





\*Sold in pairs only.

2 1/4" Brackets fit 2 1/4" smooth or fluted wood poles.

Note: Return indicates distance from wall to center of pole. Projection indicates distance from wall to back of pole.

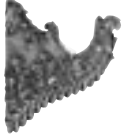
|  |  |   |  |  |
|--|--|---|--|--|
|  <p><b>PO214MCMBK</b><br/>2 1/4" Metal Ceiling Mount<br/>1" (2.5 cm) W x 3 3/4" (9.5 cm) H x 3 1/4" (8.3 cm) D;<br/>Base: 1" (2.5 cm) W x 3 1/4" (8.3 cm) D;<br/>Cradle: 1" (2.5 cm) W x 2 7/16" (6.3 cm) ID x 2 3/4" (7.0 cm) OD<br/>Drop (distance from ceiling to bottom of pole): 3 5/8" (9.2 cm)</p> <p>\$49.50 ea</p> |  <p><b>PO214MIBK</b><br/>2 1/4" Metal Inside Mount<br/>1" (2.5 cm) W x 1 5/8" (4.1 cm) H x 2 7/8" (7.3 cm) D</p> <p>\$93.50 pair*</p> |  <p><b>PO214WOCBK</b><br/>2 1/4" Wood Ceiling Mount<br/>1" (2.5 cm) W x 4 7/8" (10.5 cm) H x 8 5/8" (21.3 cm) D;<br/>Drop (distance from ceiling to bottom of pole): 3 5/8" (8.6 cm)</p> <p>\$60.50 ea</p> |  <p><b>PO214WOIBK</b><br/>2 1/4" Wood Inside Mount<br/>1" (2.5 cm) W x 3 3/8" (7.9 cm) H x 4 7/8" (12.4 cm) D</p> <p>\$88.00 pair*</p> |  <p><b>PO214ACBK</b><br/>Accessory<br/>RESIN<br/>1" (2.5 cm) W x 3 1/2" (8.9 cm) H x 6 3/8" (16.2 cm) D;<br/>4 3/8" (11.1 cm) RET, 3 3/8" (7.9 cm) PROJ</p> <p>\$49.50 ea</p> |
|--|--|---|--|--|

|   |   |   |  |   |
|---|---|---|--|---|
|  <p><b>PO214DUSBK</b><br/>Dunmore 3" Single<br/>RESIN<br/>1" (2.5 cm) W x 4 3/4" (12.1 cm) H x 5 3/4" (14.6 cm) D;<br/>4 1/4" (10.8 cm) RET, 3" (7.6 cm) PROJ</p> <p>\$49.50 ea</p> |  <p><b>PO214DUBDK</b><br/>Dunmore 6" Double<br/>RESIN<br/>1" (2.5 cm) W x 4 3/4" (12.1 cm) H x 8 3/4" (22.2 cm) D;<br/>7 1/8" (18.1 cm) FRONT RET, 3 3/4" (9.5 cm) BACK RET;<br/>6" (15.2 cm) FRONT PROJ, 3" (7.6 cm) BACK PROJ</p> <p>\$60.50 ea</p> |  <p><b>PO214HASBK</b><br/>Harlan 3" Single<br/>METAL<br/>3/4" (1.9 cm) W x 3 3/4" (9.5 cm) H x 5 1/2" (14.0 cm) D;<br/>4" (10.2 cm) RET, 3" (7.6 cm) PROJ</p> <p>\$55.00 ea</p> |  <p><b>PO214HAS6BK</b><br/>Harlan 6" Single<br/>METAL<br/>3/4" (1.9 cm) W x 3 3/4" (9.5 cm) H x 7 1/4" (18.4 cm) D;<br/>6" (15.2 cm) RET, 5" (12.7 cm) PROJ</p> <p>\$60.50 ea</p> |  <p><b>PO214HADBK</b><br/>Harlan 6" Double<br/>METAL<br/>3/4" (1.9 cm) W x 3 3/4" (9.5 cm) H x 7 1/4" (18.4 cm) D;<br/>6" (15.2 cm) FRONT RET, 2 5/8" (6.0 cm) BACK RET;<br/>5" (12.7 cm) FRONT PROJ, 1 7/8" (4.8 cm) BACK PROJ</p> <p>\$60.50 ea</p> |
|---|---|---|--|---|

|  |   |   |   |  |
|--|---|---|---|--|
|  <p><b>PO214LYBK</b><br/>Lyon<br/>RESIN<br/>1 5/8" (4.1 cm) W x 7 1/2" (19.1 cm) H x 6 3/4" (17.1 cm) D;<br/>4 1/8" (10.5 cm) RET, 3" (7.6 cm) PROJ</p> <p>\$82.50 ea</p> |  <p><b>PO214PRBK</b><br/>Preston<br/>RESIN<br/>1 1/2" (3.8 cm) W x 5 1/2" (14.0 cm) H x 5 3/4" (14.6 cm) D;<br/>4 1/8" (10.5 cm) RET, 3" (7.6 cm) PROJ</p> <p>\$49.50 ea</p> |  <p><b>PO214WISBK</b><br/>William 3" Single<br/>RESIN<br/>1" (2.5 cm) W x 4" (10.2 cm) H x 6" (15.2 cm) D;<br/>4 1/8" (10.5 cm) RET, 3" (7.6 cm) PROJ</p> <p>\$49.50 ea</p> |  <p><b>PO214WIS6BK</b><br/>William 6" Single<br/>RESIN<br/>1" (2.5 cm) W x 4" (10.2 cm) H x 9" (22.9 cm) D;<br/>7 1/8" (18.1 cm) RET, 6" (15.2 cm) PROJ</p> <p>\$60.50 ea</p> |  <p><b>PO214WIDBK</b><br/>William 6" Double<br/>RESIN<br/>1" (2.5 cm) W x 3 7/8" (9.8 cm) H x 9" (22.9 cm) D;<br/>7 1/8" (18.1 cm) FRONT RET, 3 1/4" (8.3 cm) BACK RET;<br/>6" (15.2 cm) FRONT PROJ, 2 5/8" (6.7 cm) BACK PROJ</p> <p>\$60.50 ea</p> |
|--|---|---|---|--|

\*Sold in pairs only.

**2 1/4" Wood Poles**

Note: All orders with poles and/or traverse track will incur a \$10.00 packaging fee per order.

|                                      |                                       |                                       |                                       |  |  |  |  |
|--------------------------------------|---------------------------------------|---------------------------------------|---------------------------------------|--|--|--|--|
| PO214FL02<br>2' Fluted<br>\$66.00 ea | PO214FL04<br>4' Fluted<br>\$132.00 ea | PO214FL06<br>6' Fluted<br>\$198.00 ea | PO214FL08<br>8' Fluted<br>\$264.00 ea | PO214FL10<br>10' Fluted<br>\$330.00 ea | PO214FL12<br>12' Fluted<br>\$396.00 ea | PO214FL14<br>14' Fluted<br>\$462.00 ea | PO214FL16<br>16' Fluted<br>\$528.00 ea |
|--------------------------------------|---------------------------------------|---------------------------------------|---------------------------------------|--|--|--|--|

|                                      |                                       |                                       |                                       |  |  |  |  |
|--------------------------------------|---------------------------------------|---------------------------------------|---------------------------------------|--|--|--|--|
| PO214SM02<br>2' Smooth<br>\$66.00 ea | PO214SM04<br>4' Smooth<br>\$132.00 ea | PO214SM06<br>6' Smooth<br>\$198.00 ea | PO214SM08<br>8' Smooth<br>\$264.00 ea | PO214SM10<br>10' Smooth<br>\$330.00 ea | PO214SM12<br>12' Smooth<br>\$396.00 ea | PO214SM14<br>14' Smooth<br>\$462.00 ea | PO214SM16<br>16' Smooth<br>\$528.00 ea |
|--------------------------------------|---------------------------------------|---------------------------------------|---------------------------------------|--|--|--|--|





**2 1/4" Rings** fit 2 1/4" smooth or fluted wood poles.

Note: Ring drop indicates distance from bottom of pole to bottom of ring. A ring's drop changes on different diameter poles.

|   |   |   |   |
|---|---|---|---|
|  |            |              |            |
| PO214MRI  | PO214WRI  | PO214FORI   | PO214LYRI   |
| 2 1/4" Metal Ring   | 2 1/4" Wood Ring  | Forrest Ring  | Lyon Ring   |
| METAL<br>1/4" (cm) W<br>2 1/2" (cm) ID x<br>3" (7.6 cm) OD<br>1/2" (1.3 cm) DROP  | WOOD<br>1/2" (1.3 cm) W<br>2 5/8" (6.7 cm) ID x<br>3 5/8" (9.2 cm) OD<br>7/8" (2.2 cm) DROP | METAL<br>3/16" (0.5 cm) W<br>2 3/4" (7.0 cm) ID x<br>3 1/8" (7.9 cm) OD<br>3/4" (1.9 cm) DROP | RESIN<br>5/8" (1.6 cm) W<br>3" (7.6 cm) ID x<br>4 1/4" (10.8 cm) OD<br>1 3/8" (3.5 cm) DROP |
| \$7.70 ea   | \$9.90 ea   | \$7.70 ea   | \$16.50 ea  |

**2 1/4" Accessories**

Note: Hinged Resin Elbow and 41" Metal Wand available in any Portfolio finish.

|   |  |  |  |   |
|---|--|--|--|---|
|          | <i>Note: Elbow has smaller diameter to allow 2 1/4" rings to get closer to the corner.</i> |  |  |  |
| PO214REL  |  | POAC36WAND   | POAC48WAND   | POME41WAND  |
| 2 1/4" Hinged Resin Elbow   |  | 36" Clear Acrylic Wand   | 48" Clear Acrylic Wand   | 41" Metal Wand  |
| 2 3/8" (6.0 cm) DIA<br>5 1/8" (13.0 cm) TOTAL LENGTH<br>2 3/8" (6.5 cm) each side when bent |  | ACRYLIC, CLEAR ONLY<br>1/2" (1.3 cm) DIA x<br>36" (91.4 cm) LENGTH   | ACRYLIC, CLEAR ONLY<br>1/2" (1.3 cm) DIA x<br>48" (121.9 cm) LENGTH  | 5/8" (1.6 cm) DIA x<br>41" (104.1 cm) LENGTH  |
| \$55.00 ea  |  | \$44.00 ea   | \$49.50 ea   | \$44.00 ea  |

\*Sold in pairs only.

# Portfolio Holdbacks

Available in any Portfolio finish.

HOLDBACK MEDALLIONS AND HOLDBACK STEMS SOLD SEPARATELY.





## Metal Holdback Medallions

Note: Metal Holdback Medallions only fit Metal Holdback Stems. Order Metal Holdback Stems separately.

|   |  |   |  |   |  |
|---|--|---|--|---|--|
|  <p><b>POACHB</b><br/>Achilles<br/>METAL<br/>2½" (6.4 cm) SQ x<br/>½" (1.3 cm) THICK<br/>\$88.00 pair*</p> |  <p><b>POBKHB</b><br/>Blake - Mercury Glass<br/>METAL AND GLASS<br/>3" (7.6 cm) DIA x<br/>2⅝" (6.0 cm) THICK<br/>\$132.00 pair*</p> |  <p><b>POJEHB</b><br/>Jem<br/>METAL<br/>2½" (6.4 cm) DIA x<br/>⅜" (1.0 cm) THICK<br/>\$66.00 pair*</p> |  <p><b>POLAHB</b><br/>Larkspur<br/>METAL<br/>6" (15.2 cm) W x<br/>¾" (1.9 cm) THICK<br/>\$77.00 pair*</p> | <p><i>Note:<br/>Stem attaches<br/>to back of the<br/>medallion in the<br/>area behind the<br/>base of the leaves,<br/>not in center<br/>of medallion.</i></p> |  <p><b>POMARHB</b><br/>Mara<br/>METAL<br/>3" (7.6 cm) DIA x<br/>7/8" (2.2 cm) THICK<br/>\$99.00 pair*</p> |
|---|--|---|--|---|--|

## Metal Holdback Stems Select 2", 4" or 6" projection.







Projection indicates distance from wall to back of medallion.

|  |   |  |   |   |
|--|---|--|---|---|
|  <p><b>POMAHB</b><br/>Marcus<br/>METAL<br/>1½" (3.8 cm) DIA x<br/>½" (1.3 cm) THICK<br/>\$44.00 pair*</p> |  <p><i>Note:<br/>Stem attaches to<br/>back of the<br/>medallion in the<br/>area behind the<br/>largest group of<br/>leaves, not in center<br/>of medallion.</i></p> <p><b>POOCHB</b><br/>Octavia<br/>METAL<br/>5⅞" (14.9 cm) W x<br/>½" (1.3 cm) THICK<br/>\$77.00 pair*</p> |  <p><b>POMESTEM2</b><br/>2" Stem<br/>METAL<br/>Base: 2" (5.1 cm) DIA<br/>Stem: ½" (1.3 cm) DIA<br/>2" (5.1 cm) Projection<br/>\$27.50 pair*</p> |  <p><b>POMESTEM4</b><br/>4" Stem<br/>METAL<br/>Base: 2" (5.1 cm) DIA<br/>Stem: ½" (1.3 cm) DIA<br/>4" (10.2 cm) Projection<br/>\$27.50 pair*</p> |  <p><b>POMESTEM6</b><br/>6" Stem<br/>METAL<br/>Base: 2" (5.1 cm) DIA<br/>Stem: ½" (1.3 cm) DIA<br/>6" (15.2 cm) Projection<br/>\$27.50 pair*</p> |
|--|---|--|---|---|

## Resin Holdback Medallions

Note: Resin Holdback Medallions fit your choice of Metal, Resin, or Traditional Resin Holdback Stems. Stems are sold separately. Order style of Stem and select a projection of 2", 4", or 6". Projection indicates distance from wall to back of medallion. Larger medallions work best with the Traditional Resin Stem for added support.

|   |   |  |  |  |  |
|---|---|--|--|--|--|
|  <p><b>POBEHB</b><br/>Bernadette<br/>RESIN<br/>4½" (11.4 cm) DIA x<br/>1¼" (3.2 cm) THICK<br/>\$110.00 pair*</p> |  <p><b>POBLHB</b><br/>Blois<br/>RESIN<br/>3¾" (9.5 cm) DIA x<br/>¾" (1.9 cm) THICK<br/>\$66.00 pair*</p> |  <p><b>POBXHB</b><br/>Braxton<br/>RESIN<br/>5" (12.7 cm) DIA x<br/>1½" (3.8 cm) THICK<br/>\$88.00 pair*</p> |  <p><b>POBRHB</b><br/>Brooks<br/>RESIN<br/>4" (10.2 cm) W x<br/>¾" (1.9 cm) THICK<br/>\$77.00 pair*</p> |  <p><b>POCHHB</b><br/>Chenonceau<br/>RESIN<br/>3¾" (9.5 cm) DIA x<br/>¾" (1.9 cm) THICK<br/>\$66.00 pair*</p> |  <p><b>POCKHB</b><br/>Clark<br/>RESIN<br/>3" (7.6 cm) DIA x<br/>1" (2.5 cm) THICK<br/>\$77.00 pair*</p> |
|---|---|--|--|--|--|

|   |  |  |  |  |  |
|---|--|--|--|--|--|
|  <p><b>POCLHB</b><br/>Claude<br/>RESIN<br/>5½" (14.0 cm) DIA x<br/>1" (2.5 cm) THICK<br/>\$60.50 pair*</p> |  <p><b>PODRHB</b><br/>Drake<br/>RESIN<br/>4½" (11.4 cm) DIA x<br/>⅞" (2.9 cm) THICK<br/>\$88.00 pair*</p> |  <p><b>POGEHB</b><br/>Genette<br/>RESIN<br/>4" (10.2 cm) DIA x<br/>1¼" (3.2 cm) THICK<br/>\$99.00 pair*</p> |  <p><b>POGLHB</b><br/>Gloria<br/>RESIN<br/>5" (12.7 cm) DIA x<br/>1⅝" (3.5 cm) THICK<br/>\$110.00 pair*</p> |  <p><b>POHUHB</b><br/>Hustle<br/>RESIN<br/>3½" (8.9 cm) DIA x<br/>1" (2.5 cm) THICK<br/>\$77.00 pair*</p> |  <p><b>POISHB</b><br/>Isabelle<br/>RESIN<br/>5½" (14.0 cm) DIA x<br/>1¼" (3.2 cm) THICK<br/>\$77.00 pair*</p> |
|---|--|--|--|--|--|

\*Sold in pairs only.

**Portfolio Holdbacks** HOLDBACK MEDALLIONS AND HOLDBACK STEMS SOLD SEPARATELY.



**Resin Holdback Medallions (continued)**

Note: Resin Holdback Medallions fit your choice of Metal, Resin, or Traditional Resin Holdback Stems. Stems are sold separately. Order style of Stem and select a projection of 2", 4", or 6". Projection indicates distance from wall to back of medallion. Larger medallions work best with the Traditional Resin Stem for added support.

|  |   |  |   |   |   |
|--|---|--|---|---|---|
|  <p><b>POLGHB</b><br/>Laguna<br/>RESIN<br/>3¼" (8.3 cm) DIA x<br/>¾" (1.9 cm) THICK<br/>\$66.00 pair*</p> |  <p><b>POLYHB</b><br/>Lyon<br/>RESIN<br/>4¾" (12.1 cm) DIA x<br/>2½" (6.4 cm) THICK<br/>\$110.00 pair*</p>   |  <p><b>POMIHB</b><br/>Miranda<br/>RESIN<br/>5" (12.7 cm) DIA x<br/>1½" (3.8 cm) THICK<br/>\$88.00 pair*</p> |  <p><b>POMRHB</b><br/>Mirna<br/>RESIN<br/>4½" (11.4 cm) DIA x<br/>1¼" (3.2 cm) THICK<br/>\$110.00 pair*</p> |  <p><b>PONEHB</b><br/>Newport<br/>RESIN<br/>3¼" (8.3 cm) DIA x<br/>¾" (1.9 cm) THICK<br/>\$66.00 pair*</p> |  <p><b>POSAHB</b><br/>Savannah<br/>RESIN<br/>4½" (11.4 cm) DIA x<br/>¾" (1.9 cm) THICK<br/>\$66.00 pair*</p> |
|  <p><b>POSUHB</b><br/>Sunset<br/>RESIN<br/>3½" (8.9 cm) DIA x<br/>¾" (1.9 cm) THICK<br/>\$66.00 pair*</p> |  <p><b>POSWHB</b><br/>Swindon<br/>RESIN<br/>5½" (13.0 cm) DIA x<br/>1¼" (3.2 cm) THICK<br/>\$88.00 pair*</p> |  <p><b>POTRHB</b><br/>Trudy<br/>RESIN<br/>4¾" (12.1 cm) DIA x<br/>¾" (1.9 cm) THICK<br/>\$77.00 pair*</p>   |  <p><b>POTWHB</b><br/>Twirl<br/>RESIN<br/>3½" (8.9 cm) DIA x<br/>1" (2.5 cm) THICK<br/>\$77.00 pair*</p>    |  <p><b>POVEHB</b><br/>Venice<br/>RESIN<br/>3½" (8.9 cm) DIA x<br/>¾" (1.9 cm) THICK<br/>\$66.00 pair*</p>  |   |

**Metal Holdback Stems** Select 2", 4" or 6" projection.



Projection indicates distance from wall to back of medallion.

|  |   |   |
|--|---|---|
|  <p><b>POMESTEM2</b><br/>2" Stem<br/>Base: 2" (5.1 cm) DIA<br/>Stem: ½" (1.3 cm) DIA<br/>2" (5.1 cm) PROJ<br/>\$27.50 pair*</p> |  <p><b>POMESTEM4</b><br/>4" Stem<br/>Base: 2" (5.1 cm) DIA<br/>Stem: ½" (1.3 cm) DIA<br/>4" (10.2 cm) PROJ<br/>\$27.50 pair*</p> |  <p><b>POMESTEM6</b><br/>6" Stem<br/>Base: 2" (5.1 cm) DIA<br/>Stem: ½" (1.3 cm) DIA<br/>6" (15.2 cm) PROJ<br/>\$27.50 pair*</p> |
|--|---|---|

**Resin Holdback Stems**

Select 2", 4" or 6" projection.

Projection indicates distance from wall to back of medallion.

|   |  |  |
|---|--|--|
|  <p><b>PORESTEM2</b><br/>2" Stem<br/>Base: 3½" (7.9 cm) DIA<br/>Stem: ¾" (1.9 cm) DIA<br/>2" (5.1 cm) PROJ<br/>\$33.00 pair*</p> |  <p><b>PORESTEM4</b><br/>4" Stem<br/>Base: 3½" (7.9 cm) DIA<br/>Stem: ¾" (1.9 cm) DIA<br/>4" (10.2 cm) PROJ<br/>\$33.00 pair*</p> |  <p><b>PORESTEM6</b><br/>6" Stem<br/>Base: 3½" (7.9 cm) DIA<br/>Stem: ¾" (1.9 cm) DIA<br/>6" (15.2 cm) PROJ<br/>\$33.00 pair*</p> |
|---|--|--|

**Traditional Resin Holdback Stems**

Select 2", 4" or 6" projection.

Projection indicates distance from wall to back of medallion.

|   |   |   |
|---|---|---|
|  <p><b>POSTEM2</b><br/>2" Stem<br/>Base: 2½" (6.4 cm) DIA<br/>Stem: 1½" (3.8 cm) DIA<br/>2" (5.1 cm) PROJ<br/>\$33.00 pair*</p> |  <p><b>POSTEM4</b><br/>4" Stem<br/>Base: 2½" (6.4 cm) DIA<br/>Stem: 1½" (3.8 cm) DIA<br/>4" (10.2 cm) PROJ<br/>\$33.00 pair*</p> |  <p><b>POSTEM6</b><br/>6" Stem<br/>Base: 2½" (6.4 cm) DIA<br/>Stem: 1½" (3.8 cm) DIA<br/>6" (15.2 cm) PROJ<br/>\$33.00 pair*</p> |
|---|---|---|

\*Sold in pairs only.

Holdback Accessories

Note: Projection indicates distance from wall to back of medallion.

|  |  |
|--|--|
|  <p><b>POMEBAND</b><br/>1" Holdback Medallion Band</p> <p>METAL<br/>¾" (1.9 cm) W x<br/>1 1/16" (3.4 cm) ID,<br/>1 3/16" (3.4 cm) OD</p> <p>\$33.00 ea</p> <p><b>Note:</b> 1" Holdback Medallion Band attaches any holdback medallion to the front of a 1" diameter pole.<br/>Holdback Medallion sold separately.</p> |  <p><b>POHBARM</b><br/>Holdback Arm</p> <p>METAL<br/>7" (17.8 cm) W x<br/>½" (1.3 cm) DIA X<br/>1 5/8" (4.1 CM) H X<br/>5 ½" (14.0 cm) D;<br/>4 ½" (11.4 CM) PROJ</p> <p>\$55.00 pair</p> <p><b>Note:</b> Metal Holdback Arm may be used with any 1" resin or metal finial without cuff. Finials sold separately.<br/>Metal Holdback Arms look best with 1" Textured Metal Finials.</p> |
|--|--|

Common uses for 1" Holdback Medallion Band:

1. repeated decorative embellishment along the length of a pole

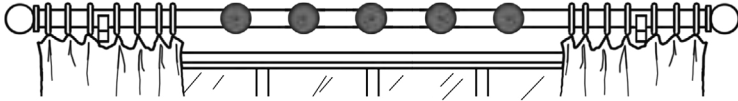

2. hold gathered rod pocket drapery panel in place

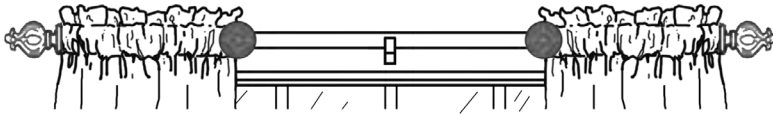

3. ring stop

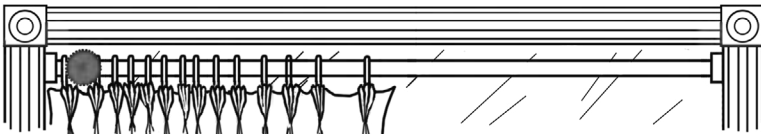





\*Sold in pairs only.

# Corded and Motorized Traverse Systems

## CORDED AND MOTORIZED TRAVERSE CONFIGURATIONS

(Pictured with Heavy-Duty Corded Traverse System.)

| <p>Heavy-Duty<br/>Ball Bearing<br/>Traverse</p> <p>pinch pleat or Ripplefold® style</p> | <p>BTX DC and<br/>Somfy Glydea™<br/>Motorized Traverse</p> <p>pinch pleat or Ripplefold® style</p> |   |
|---|--|---|
| ●   | ●  | <p><b>Single Traverse System without Rings</b></p>                                  |
| ●   | ●  | <p><b>Double Traverse System without Rings</b></p>                                  |
| ●   | ●  | <p><b>Single or Double System<br/>with Mitered Return</b></p>                     |
| ●   | ●  | <p><b>Double System with Back Traverse<br/>and Stationary Pole in Front</b></p>  |

All traverse systems are available with or without decorative wood fascia.

## Corded Traverse Systems

# Heavy-Duty Ball Bearing Traverse System

For Pinch Pleat or Ripplefold® style

| HEAVY-DUTY BALL BEARING SYSTEM FEATURES | Heavy Duty Ball Bearing Traverse System   |
|---|---|
| 2" and 2¼" Wood Fascia Available        | yes                                       |
| 2¼" C-Rings Available                   | no  |
| Ripplefold® Available                   | yes                                       |
| Maximum Track Length                    | 20 ft continuous; spliced to 40 ft        |
| Maximum Continuous Wood Fascia Length   | 16 ft for Portfolio; 12 ft for Quick Ship |

## 1. Choose a style

Single or Double system  
Center or One-Way Draw  
With or without rings



Single Traverse System without Rings



Double Traverse System without Rings



Single or Double System with Mitered Return



Double System with Back Traverse and Stationary Pole in Front

## 2. Choose a glide

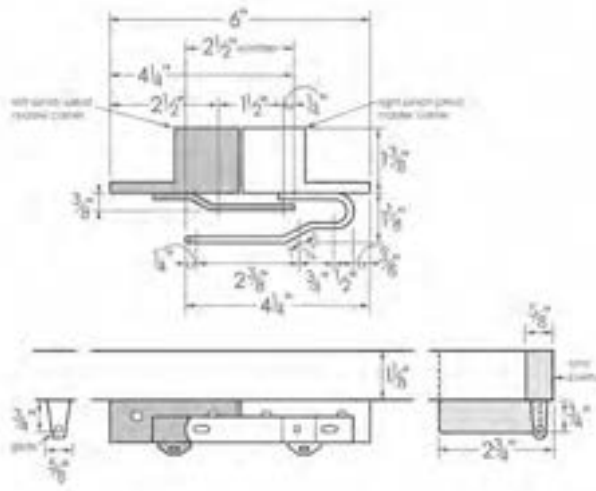

Standard Pinch Pleat

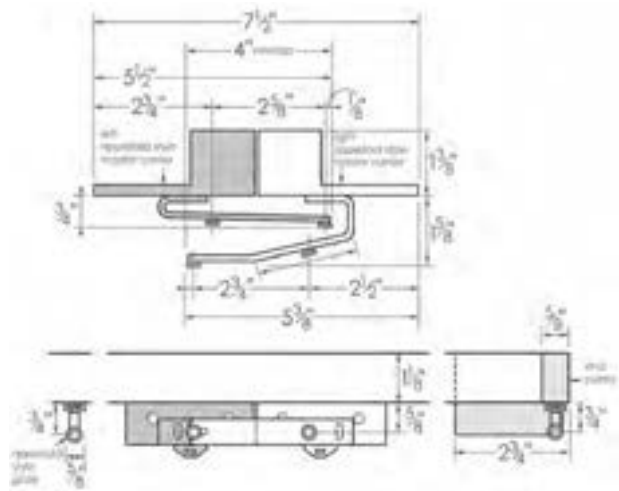

Ripplefold® style

All Systems may be ordered with or without decorative wood fascia.  
Finials may be ordered separately from 2" or 2¼" Portfolio or Quick Ship Wood and Resin.



### 3. Choose a fascia and finish

2" or 2¼" fascia  
fluted or smooth profile

30 Portfolio finishes  
5 Quick Ship Wood and Resin finishes  
PTH Perfect Match™

| Portfolio Diameter | Smooth or Fluted Wood Fascia Finish | Track and Bracket* Color | Component Color<br>Components include glides, master carriers and track end caps |
|--------------------|-------------------------------------|--------------------------|--|
| 2" and 2¼"         | Amulet                              | Bronze                   | White  |
| 2" and 2¼"         | Andiron                             | Bronze                   | White  |
| 2" and 2¼"         | Antique Gold                        | Gold                     | White  |
| 2" and 2¼"         | Antique Gold Leaf                   | Gold                     | White  |
| 2" and 2¼"         | Art Bronze                          | Bronze                   | White  |
| 2" and 2¼"         | Barnwood                            | Bronze                   | White  |
| 2" and 2¼"         | Black                               | Bronze                   | White  |
| 2" and 2¼"         | Cinnamon                            | Bronze                   | White  |
| 2" and 2¼"         | Dark Chocolate                      | Bronze                   | White  |
| 2" and 2¼"         | Eternal                             | Gold                     | White  |
| 2" and 2¼"         | Firelight                           | Gold                     | White  |
| 2" and 2¼"         | Goldenrod                           | Gold                     | White  |
| 2" and 2¼"         | Gossamer                            | Bronze                   | White  |
| 2" and 2¼"         | Halo                                | Bronze                   | White  |
| 2" and 2¼"         | Java                                | Bronze                   | White  |
| 2" and 2¼"         | Linen                               | Gold                     | White  |
| 2" and 2¼"         | Mink                                | Bronze                   | White  |
| 2" and 2¼"         | Moonlight                           | Bronze                   | White  |
| 2" and 2¼"         | Mystic                              | Gold                     | White  |
| 2" and 2¼"         | New Age Bronze                      | Bronze                   | White  |
| 2" and 2¼"         | Parchment                           | Gold                     | White  |
| 2" and 2¼"         | Shimmer                             | Bronze                   | White  |
| 2" and 2¼"         | Silver Maple                        | Bronze                   | White  |
| 2" and 2¼"         | Spicewood                           | Bronze                   | White  |
| 2" and 2¼"         | Spun Gold                           | Gold                     | White  |
| 2" and 2¼"         | Starlet                             | Bronze                   | White  |
| 2" and 2¼"         | Timber                              | Bronze                   | White  |
| 2" and 2¼"         | Titanium                            | Bronze                   | White  |
| 2" and 2¼"         | Urban Bronze                        | Gold                     | White  |
| 2" and 2¼"         | White                               | Gold                     | White  |
| 2" and 2¼"         | PTH Perfect Match™                  | please specify           | White  |

| Quick Ship Diameter | Smooth or Fluted Wood Fascia Finish | Track and Bracket* Color | Component Color<br>Components include glides, master carriers and track end caps |
|---------------------|-------------------------------------|--------------------------|--|
| 2¼" Wood and Resin  | Antique Brass                       | Gold                     | White  |
|                     | Oil Rubbed Bronze                   | Bronze                   | White  |
|                     | Platinum                            | Bronze                   | White  |
|                     | Rose Gold                           | Gold                     | White  |
|                     | Walnut                              | Bronze                   | White  |

\*White brackets may be substituted upon request

## Corded Traverse Systems

# Heavy-Duty Ball Bearing Traverse Pricing

**Note:** All orders with poles and/or traverse rods will incur a \$10.00 packaging fee per order.

| Item #   | Name   | Price    |            |            |            |            |            |            |            |            |                                      | Unit  |
|--|--|----------|------------|------------|------------|------------|------------|------------|------------|------------|--------------------------------------|---|
| <b>Heavy-Duty Ball Bearing Traverse System with Wood Fascia</b>                          |  |          |            |            |            |            |            |            |            |            |                                      | Finishes: Bronze(BR), Gold(GO) or White(WH) |
| <b>Single Track System with Wood Fascia</b>  |  |          |            |            |            |            |            |            |            |            |                                      |   |
|  |  | 4'       | 6'         | 8'         | 10'        | 12'        | 14'        | 16'        | 18'        | 20'        | Additional <sup>2</sup><br>up to 38' | Unit  |
| BB01   | Center Draw - No Rings   | \$446.20 | \$669.30   | \$892.40   | \$1,115.50 | \$1,338.60 | \$1,561.70 | \$1,784.80 | \$2,007.90 | \$2,231.00 | \$223.10                             | Each  |
| BB03   | One-Way Draw - No Rings  | \$446.20 | \$669.30   | \$892.40   | \$1,115.50 | \$1,338.60 | \$1,561.70 | \$1,784.80 | \$2,007.90 | \$2,231.00 | \$223.10                             | Each  |
| <b>Double Track System with Wood Fascia on Front Only</b>                                |  |          |            |            |            |            |            |            |            |            |                                      |   |
| BB05   | Double Center Draw - No Rings - Fascia Front Only                            | \$694.60 | \$1,041.90 | \$1,389.20 | \$1,736.50 | \$2,083.80 | \$2,431.10 | \$2,778.40 | \$3,125.70 | \$3,473.00 | \$347.30                             | Each  |
| BB07   | Double One-Way Draw - No Rings - Fascia Front Only                           | \$694.60 | \$1,041.90 | \$1,389.20 | \$1,736.50 | \$2,083.80 | \$2,431.10 | \$2,778.40 | \$3,125.70 | \$3,473.00 | \$347.30                             | Each  |
| <b>Double Track System with Wood Fascia on Front and Back</b>                            |  |          |            |            |            |            |            |            |            |            |                                      |   |
| BB09   | Double Center Draw - No Rings - Fascia Front and Back                        | \$892.40 | \$1,338.60 | \$1,784.80 | \$2,231.00 | \$2,677.20 | \$3,123.40 | \$3,569.60 | \$4,015.80 | \$4,462.00 | \$446.20                             | Each  |
| BB11   | Double One-Way Draw - No Rings - Fascia Front and Back                       | \$892.40 | \$1,338.60 | \$1,784.80 | \$2,231.00 | \$2,677.20 | \$3,123.40 | \$3,569.60 | \$4,015.80 | \$4,462.00 | \$446.20                             | Each  |
| <b>Double System with Wood Fascia on Back Track and Full Stationary Pole on Front</b>    |  |          |            |            |            |            |            |            |            |            |                                      |   |
| BB23   | Center Draw - With Glides (Rings for Front Pole must be ordered separately)  | \$664.70 | \$922.30   | \$1,179.90 | \$1,437.50 | \$1,695.10 | \$1,952.70 | \$2,210.30 | \$2,467.90 | \$2,725.50 | \$257.60                             | Each  |
| BB24   | One-Way Draw - With Glides (Rings for Front Pole must be ordered separately) | \$664.70 | \$922.30   | \$1,179.90 | \$1,437.50 | \$1,695.10 | \$1,952.70 | \$2,210.30 | \$2,467.90 | \$2,725.50 | \$257.60                             | Each  |
| <b>Double System without Wood Fascia on Back Track and Full Stationary Pole on Front</b> |  |          |            |            |            |            |            |            |            |            |                                      |   |
| BB21   | Center Draw - With Glides (Rings for Front Pole must be ordered separately)  | \$535.90 | \$803.85   | \$1,071.80 | \$1,339.75 | \$1,607.70 | \$1,875.65 | \$2,143.60 | \$2,411.55 | \$2,679.50 | \$267.95                             | Each  |
| BB22   | One-Way Draw - With Glides (Rings for Front Pole must be ordered separately) | \$535.90 | \$803.85   | \$1,071.80 | \$1,339.75 | \$1,607.70 | \$1,875.65 | \$2,143.60 | \$2,411.55 | \$2,679.50 | \$267.95                             | Each  |

## Heavy-Duty Ball Bearing Traverse System without Wood Fascia or Rings

Finishes: Bronze(BR), Gold(GO) or White(WH)

| <b>Single Track System</b> |                                   |          |          |          |            |            |            |            |            |            |                                      | Unit |
|----------------------------|-----------------------------------|----------|----------|----------|------------|------------|------------|------------|------------|------------|--------------------------------------|------|
|                            |                                   | 4'       | 6'       | 8'       | 10'        | 12'        | 14'        | 16'        | 18'        | 20'        | Additional <sup>2</sup><br>up to 38' | Unit |
| BB13                       | Center Draw - With Glides         | \$248.40 | \$372.60 | \$496.80 | \$621.00   | \$745.20   | \$869.40   | \$993.60   | \$1,117.80 | \$1,242.00 | \$124.20                             | Each |
| BB14                       | One-Way Draw - With Glides        | \$248.40 | \$372.60 | \$496.80 | \$621.00   | \$745.20   | \$869.40   | \$993.60   | \$1,117.80 | \$1,242.00 | \$124.20                             | Each |
| <b>Double Track System</b> |                                   |          |          |          |            |            |            |            |            |            |                                      |      |
| BB15                       | Double Center Draw - With Glides  | \$496.80 | \$745.20 | \$993.60 | \$1,242.00 | \$1,490.40 | \$1,738.80 | \$1,987.20 | \$2,235.60 | \$2,484.00 | \$248.40                             | Each |
| BB16                       | Double One-Way Draw - With Glides | \$496.80 | \$745.20 | \$993.60 | \$1,242.00 | \$1,490.40 | \$1,738.80 | \$1,987.20 | \$2,235.60 | \$2,484.00 | \$248.40                             | Each |

- **Continuous traverse system lengths 6' to 20':** Track will ship unspliced and fascia will be blended for a seamless look. A blended fascia fee of \$54 net will be applied to each traverse system over 12' and up to 20'. Track and fascia ships in one continuous length.
- **Spliced traverse systems under 20':** Track and fascia may be spliced upon request. A splicing fee of \$54 net will be applied. Track will be spliced in the center. The location of the fascia splice will be at the discretion of PTH. Fascia will be miter cut diagonally and shipped with a connector plate to reinforce the seam. Wood glue is not included and must be supplied by installer.
- **Spliced traverse system lengths 20' to 38':** Track will be spliced in the center and fascia will be spliced at no charge. The location of the fascia splice will be at the discretion of PTH. Blended fascia is available upon request for a fee of \$54 net. Blended fascia ships in one continuous length.

## Additional Accessories and Fees

|        |   |                                    |         |      |
|--------|---|------------------------------------|---------|------|
| BBTB35 | Ball Bearing Single Bracket               | Bronze (BR), Gold (GO), White (WH) | \$24.15 | Each |
| BBTB   | Ball Bearing Double Bracket               | Bronze (BR), Gold (GO), White (WH) | \$33.35 | Each |
| BBBCM  | Ball Bearing Ceiling Mount Bracket        | White (WH)                         | \$11.50 | Each |
| BB55   | Ball Bearing Heavy-Duty Glide             |                                    | \$3.45  | Each |
| BB56   | Ball Bearing Master Carrier               |                                    | \$24.15 | Each |
| BB59   | Ball Bearing Master Carrier Arm Extension |                                    | \$29.90 | Each |
| BB63   | Ball Bearing End Pulley                   |                                    | \$24.15 | Each |
| BB64   | Ball Bearing Cord Tension Pulley          |                                    | \$24.15 | Each |

|                         |                                |                                   |              |      |
|-------------------------|--------------------------------|-----------------------------------|--------------|------|
| BB61                    | Blended Fascia                 | Portfolio and Quick Ship finishes | \$124.20 Net | Each |
| BB62                    | Splicing Fee                   | Portfolio and Quick Ship finishes | \$62.10 Net  | Each |
| BB57                    | Miter Cut 3" return (per pair) | Portfolio and Quick Ship finishes | \$52.79 Net  | Pair |
| BB58                    | Miter Cut 6" return (per pair) | Portfolio and Quick Ship finishes | \$52.79 Net  | Pair |
| BBOVBKS                 | Ball Bearing Over-Bracket      | Portfolio and Quick Ship finishes | \$74.75      | Each |
| PACKAGING FEE under 16' |                                |                                   | \$10.00 Net  | Each |
| PACKAGING FEE over 16'  |                                |                                   | \$25.00 Net  | Each |

# Heavy-Duty Ball Bearing Traverse System Information

| Quantity included per set will be based on cut pole length       | 4' | 6' | 7' | 8' | 9' | 10' | 11' | 12' | 13' | 14' | 15' | 16' | 17' | 18' | 19' | 20' |
|--|----|----|----|----|----|-----|-----|-----|-----|-----|-----|-----|-----|-----|-----|-----|
| Glides [4 per ft, includes master carriers (2) and end caps (2)] | 16 | 24 | 28 | 32 | 36 | 40  | 44  | 48  | 52  | 56  | 60  | 64  | 68  | 72  | 76  | 80  |
| Brackets (1 per every 3-4 feet)                                  | 2  | 3  | 3  | 4  | 4  | 4   | 5   | 5   | 5   | 6   | 6   | 6   | 7   | 7   | 7   | 8   |

## Heavy-Duty Ball Bearing Brackets

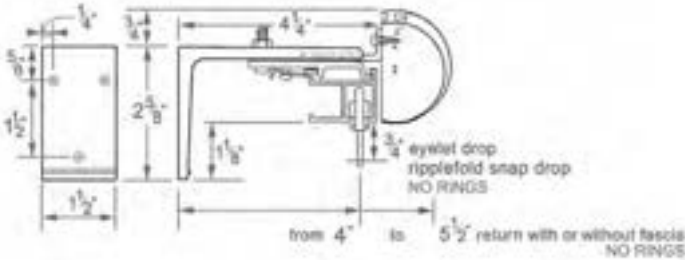

**BB50 Adjustable 4"- 5 1/4" Single Bracket**

- available in Gold, Bronze or White
- included in Single Systems

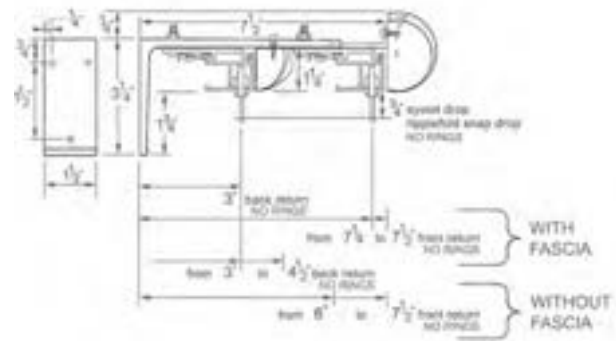

**BB51 Adjustable 6"- 7" Double Bracket**

- available in Gold, Bronze or White
- included in Double Systems; may be substituted for Single Systems

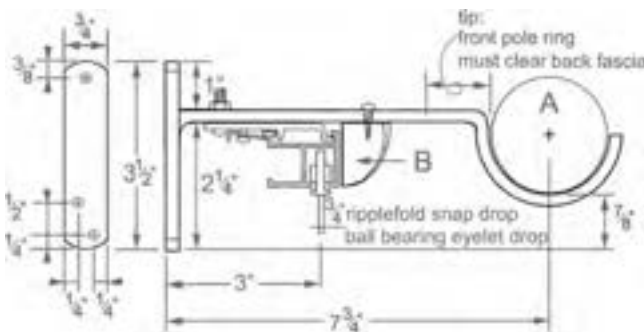

**BBOVBKS Ball Bearing Over Bracket**

- available in Portfolio, Quick Ship Wood and Resin, and PTH Perfect Match™ finishes
- included in Double Systems with full stationary pole on front

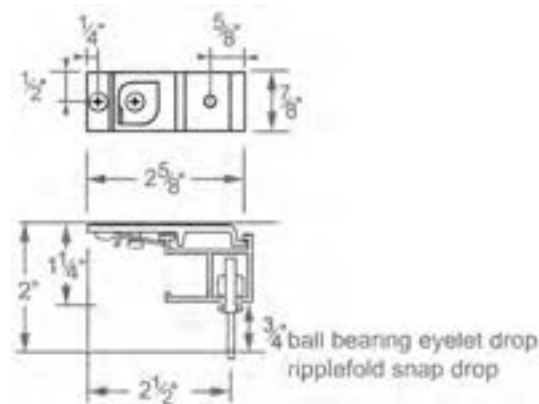

**BBCM Single Ceiling Mount Bracket**

- available in White
- single bracket; may be substituted in Single and Double Systems

## Heavy-Duty Ball Bearing Traverse System

### Product information

- Heavy duty ball bearing traversing track recommended for heavy-weight draperies or drapery mounted over 10 feet from floor.
- Single ball bearing traverse system price includes: traversing track, 2 adjustable end brackets, an additional adjustable bracket every 3 - 4 feet, and 3 - 4 carriers per foot.
- Sold in 2-foot increments, 4-foot minimum.
- Cut to specified length. Fall off will not be saved or shipped.
- Track maximum length up to 240 inches (20 ft.)
- Track and matching bracket available in Gold, Bronze or White.
- Carriers and end pulleys available in White only
- Center or One-Way draw available
- Fascia, if selected, in 2" or 2 1/4" wood pole profiles, available up to 16 ft. in Portfolio or 12 ft. in Quick Ship, is clipped onto traverse system track with a fascia L-bracket. Fascia over 16 ft. in Portfolio finishes and 12' in Quick Ship finishes will be spliced.
- Standard cord drop: 120 inches

### Please specify

- Item number for track or track with wood fascia
- Track length (track and fascia are the same length)
- Track and matching bracket color (If not specified, we will select color to match fascia finish)
- Bracket return: see above for details.
- Cord location: right or left
- Draw: center, one-way stack right or one-way stack left
- Number of carriers if different than 4 per foot
- Pinch pleat or Ripplefold® style carriers
- Cord drop (standard is 120")
- Finish name for fascia, if selected

# Motorized Traverse Systems

## Motorized Traverse System

For Pinch Pleat or Ripplefold® style

| MOTORIZED SYSTEM FEATURES             | BTX DC Motorized Traverse System             | Somfy Glydea® Motorized Traverse System      |
|---------------------------------------|--|--|
| 2" and 2¼" Wood Fascia Available      | yes  | yes  |
| 2¼" C-Rings Available                 | no   | no   |
| Ripplefold® Available                 | yes  | yes  |
| Maximum Track Length                  | 20 ft continuous; spliced to 40 ft           | 20 ft continuous; spliced to 36 ft           |
| Maximum Continuous Wood Fascia Length | 16 ft for Portfolio;<br>12 ft for Quick Ship | 16 ft for Portfolio;<br>12 ft for Quick Ship |

### 1. Choose a style

- Single or Double System
- Center or One-Way Draw
- Without rings only



Single Motorized System without Rings



Double Motorized System without Rings



Single or Double System with Mitered Return



Double System with Back Traverse and Stationary Pole in Front

All Systems may be ordered with or without decorative wood fascia.  
 Finials may be ordered separately from 2" or 2¼" Portfolio or Quick Ship Wood and Resin.

Single and Double Systems without Fascia can be curved for an additional fee:

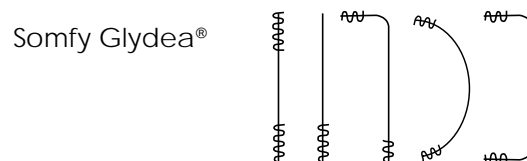
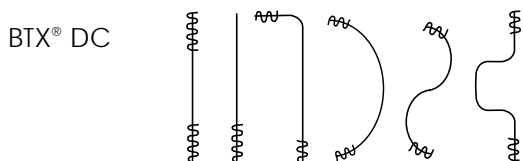

**Please note:** BTX DC systems can be curved with a minimum 18" radius for pinch pleat, 20" minimum radius for Ripplefold® style. Somfy Glydea® systems can be curved with a minimum 11.8" radius. All curves require a template. **Curving track reduces weight capacity of motor.** Please refer to motor specifications on pg. 50.

## 2. Choose a fascia and fascia finish

2" or 2¼" fascia

fluted or smooth profile

30 Portfolio finishes

5 Quick Ship Wood and Resin finishes

PTH Perfect Match™

| Portfolio Diameter | Smooth or Fluted Wood Fascia Finish | BTX DC                   |                 | Somfy Glydea®            |                 |
|--------------------|-------------------------------------|--------------------------|-----------------|--------------------------|-----------------|
|                    |                                     | Track and Bracket* Color | Component Color | Track and Bracket* Color | Component Color |
| 2" and 2¼"         | Amulet                              | Bronze                   | Bronze          | Bronze                   | White           |
| 2" and 2¼"         | Andiron                             | Bronze                   | Bronze          | Bronze                   | White           |
| 2" and 2¼"         | Antique Gold                        | Gold                     | Gold            | Gold                     | White           |
| 2" and 2¼"         | Antique Gold Leaf                   | Gold                     | Gold            | Gold                     | White           |
| 2" and 2¼"         | Art Bronze                          | Bronze                   | Bronze          | Bronze                   | White           |
| 2" and 2¼"         | Barnwood                            | Bronze                   | Bronze          | Bronze                   | White           |
| 2" and 2¼"         | Black                               | Bronze                   | Bronze          | Bronze                   | White           |
| 2" and 2¼"         | Cinnamon                            | Bronze                   | Bronze          | Bronze                   | White           |
| 2" and 2¼"         | Dark Chocolate                      | Bronze                   | Bronze          | Bronze                   | White           |
| 2" and 2¼"         | Eternal                             | Gold                     | Gold            | Gold                     | White           |
| 2" and 2¼"         | Firelight                           | Gold                     | Gold            | Gold                     | White           |
| 2" and 2¼"         | Goldenrod                           | Gold                     | Gold            | Gold                     | White           |
| 2" and 2¼"         | Gossamer                            | Bronze                   | Bronze          | Bronze                   | White           |
| 2" and 2¼"         | Halo                                | Bronze                   | Bronze          | Bronze                   | White           |
| 2" and 2¼"         | Java                                | Bronze                   | Bronze          | Bronze                   | White           |
| 2" and 2¼"         | Linen                               | Gold                     | Gold            | Gold                     | White           |
| 2" and 2¼"         | Mink                                | Bronze                   | Bronze          | Bronze                   | White           |
| 2" and 2¼"         | Moonlight                           | Bronze                   | Bronze          | Bronze                   | White           |
| 2" and 2¼"         | Mystic                              | Gold                     | Gold            | Gold                     | White           |
| 2" and 2¼"         | New Age Bronze                      | Bronze                   | Bronze          | Bronze                   | White           |
| 2" and 2¼"         | Parchment                           | Gold                     | Gold            | Gold                     | White           |
| 2" and 2¼"         | Shimmer                             | Bronze                   | Bronze          | Bronze                   | White           |
| 2" and 2¼"         | Silver Maple                        | Bronze                   | Bronze          | Bronze                   | White           |
| 2" and 2¼"         | Spicewood                           | Bronze                   | Bronze          | Bronze                   | White           |
| 2" and 2¼"         | Spun Gold                           | Gold                     | Gold            | Gold                     | White           |
| 2" and 2¼"         | Starlet                             | Bronze                   | Bronze          | Bronze                   | White           |
| 2" and 2¼"         | Timber                              | Bronze                   | Bronze          | Bronze                   | White           |
| 2" and 2¼"         | Titanium                            | Bronze                   | Bronze          | Bronze                   | White           |
| 2" and 2¼"         | Urban Bronze                        | Gold                     | Gold            | Gold                     | White           |
| 2" and 2¼"         | White                               | Gold                     | Gold            | Gold                     | White           |
| 2" and 2¼"         | PTH Perfect Match™                  | please specify           | please specify  | please specify           | White           |

| Quick Ship Diameter | Smooth or Fluted Wood Fascia Finish | BTX DC                   |                 | Somfy Glydea®            |                 |
|---------------------|-------------------------------------|--------------------------|-----------------|--------------------------|-----------------|
|                     |                                     | Track and Bracket* Color | Component Color | Track and Bracket* Color | Component Color |
| 2¼" Wood and Resin  | Antique Brass                       | Gold                     | Gold            | Gold                     | White           |
|                     | Oil Rubbed Bronze                   | Bronze                   | Bronze          | Bronze                   | White           |
|                     | Platinum                            | Bronze                   | Bronze          | Bronze                   | White           |
|                     | Rose Gold                           | Gold                     | Gold            | Gold                     | White           |
|                     | Walnut                              | Bronze                   | Bronze          | Bronze                   | White           |

\*White brackets may be substituted upon request

# Motorized Traverse Systems

## Motorized Traverse System

### 3. Choose a motor

Be sure to select the best motor for your window treatment. Use the Motor Weight Capacity chart below to determine which motor best accommodates your length of track and your drapery weight. The System Features chart on the opposite page lists the varied functions of each motor.

### Motor Weight Capacity

|              |                                     | maximum drapery weight per total length of system (lbs) |            |            |            |            |            |            |            |            |            |            |           |  |
|--------------|-------------------------------------|---|------------|------------|------------|------------|------------|------------|------------|------------|------------|------------|-----------|--|
| Motor        |                                     | 18' or less   | 20'        | 22'        | 24'        | 26'        | 28'        | 30'        | 32'        | 34'        | 36'        | 38'        | 40'       |  |
| <b>BTX</b>   | Standard <b>BTX-DC-60 Tandem</b>    | 60<br>120   | 58<br>118  | 56<br>116  | 54<br>114  | 52<br>112  | 50<br>110  | 48<br>108  | 46<br>106  | 44<br>104  | 42<br>102  | 40<br>100  | 38<br>98  |  |
|              | Heavy Duty <b>BTX-DC-120 Tandem</b> | 120<br>240  | 118<br>238 | 116<br>236 | 114<br>234 | 112<br>232 | 110<br>230 | 108<br>228 | 106<br>226 | 104<br>224 | 102<br>222 | 100<br>220 | 98<br>218 |  |
|              | Solar <b>BTX-DCS-45 Tandem</b>      | 45<br>90  | -<br>-     | -<br>-     | -<br>-     | -<br>-     | -<br>-     | -<br>-     | -<br>-     | -<br>-     | -<br>-     | -<br>-     | -<br>-    |  |
| <b>somfy</b> | Standard <b>Glydea® 35</b>          | 77  | 77         | 77         | 77         | 77         | 77         | 77         | 77         | -          | -          | -          | -         |  |
|              | Heavy Duty <b>Glydea® 60e</b>       | 132<br>220  | 132<br>220 | 132<br>220 | 132<br>220 | 132<br>220 | 132<br>220 | 132<br>220 | 132<br>220 | 132<br>220 | 132<br>220 | -<br>-     | -<br>-    |  |

**Note:** Capacity ratings are based on internal system friction only. External loads caused by fabric friction, drag, or obstructions will adversely affect pulling capacity or stop motor due to resistance. **Curving:** System curves reduce maximum drapery weight capacity by a minimum of 15% per bend. Please call us regarding weight capacity for your curved track. **Maximum System Lengths:** If you need more than the maximum spliced length for a system, two one-way systems can butt against each other behind fascia. Must be specified on your order form. An additional arm component is needed to create an overlap between the two individual systems; sold separately.

### Motorized Traverse System

includes 1 motor with power supply (1 per track), track(s) with components, brackets, and 1 standard transmitter (1 per track), and fascia with fascia clips when applicable. Somfy transformers are within the Somfy motor housing.



BTX Solar Panel  
only charges  
BTX-DCS-45  
motor  
must install in  
direct sunlight

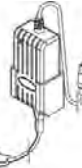

BTX Transformer  
only for BTX-DC-60  
and BTX-DC-120  
motors

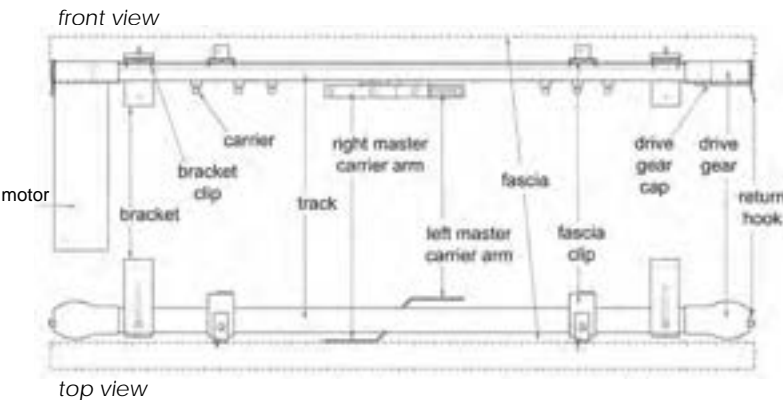

front view

top view



BTX-DC  
Standard  
Transmitter  
6 channel  
white



Somfy Glydea®  
Standard  
Transmitter  
5 channel  
white

### Additional Controls and Accessories

can be ordered at additional cost

 BTX Wireless  
Wall Switches  
single or double channel

 Somfy Wireless  
Wall Switches  
single to 5 channel

 Somfy Table Top  
Accessory  
case for wireless wall switch

 Somfy Transmitter  
single channel

 Somfy Transmitter  
with On-screen Display  
16 channel

 Somfy Indoor Sun Control  
operates draperies  
according to sun exposure

 Somfy Wall Mount Timer  
24/7 programmable timer

 Somfy Handheld Timer  
programmable timer  
6 channel

| System Features  | BTX®DC Motors  |                 |                                 | Somfy Glydea® ULTRA Motors |                                 |
|--|--|-----------------|---------------------------------|----------------------------|---------------------------------|
|  | Standard   | Heavy Duty      | Solar                           | Standard                   | Heavy Duty                      |
| System Features  | BTX-DC-60  | BTX-DC-120      | BTX-DCS-45                      | Glydea® 35                 | Glydea® 60e                     |
| center draw or one-way draw available  | X  | X               | X                               | X                          | X                               |
| Bronze or Gold track available   | X  | X               | X                               | X                          | X                               |
| Bronze or Gold components* available   | X  | X               | X                               |                            |                                 |
| White track available  | X  | X               | X                               | X                          | X                               |
| White components* available  | X  | X               | X                               | X                          | X                               |
| track maximum length   | 40'  | 40'             | 18'                             | 32'                        | 36'                             |
| maximum number of track splices  | 1  | 1               | 0                               | 1                          | 1                               |
| minimum curving radius   | 18" (45.72 CM)   | 18" (45.72 CM)  | 18" (45.72 CM)                  | 11.8" (30 CM)              | 11.8" (30 CM)                   |
| Bronze, Gold or White wall mount brackets (sgl & dbl)  | X  | X               | X                               | X                          | X                               |
| Bronze or Gold standard ceiling mount bracket  | X  | X               | X                               |                            |                                 |
| White standard ceiling mount bracket   | X  | X               | X                               | X                          | X                               |
| Motor Features   | BTX-DC-60  | BTX-DC-120      | BTX-DCS-45                      | Glydea® 35                 | Glydea® 60e                     |
| motor cord length as purchased   | 120"   | 120"            | 19"                             | 120"                       | 120"                            |
| touch motion   | X  | X               | X                               |                            | X                               |
| manual override  | X  | X               | X                               | X                          | X                               |
| soft start   |  |                 |                                 | X                          | X                               |
| soft stop  |  |                 |                                 |                            | X                               |
| speed control and adjustment   |  |                 |                                 |                            | X                               |
| average linear speed   | 12"/sec  | 12"/sec         | 12"/sec                         | 7.8" (20cm)/sec            | 4.9" (12.5cm) - 7.8" (20cm)/sec |
| motor automatically stops when system reaches fully open or fully closed position                            | X  | X               | X                               | X                          | X                               |
| adjustable limits  |  |                 |                                 |                            | X                               |
| intermediate position  |  |                 |                                 |                            | My Position                     |
| motorized track noise level  | 53db   | 59db            | 53db                            | 50 dB                      | 44 dB                           |
| maximum weight   | 60 lbs / 18 ft   | 120 lbs / 18 ft | 45 lbs / 18 ft                  | 77 lbs / 20 ft             | 132 lbs / 20 ft                 |
| tandem maximum weight  | 120 lbs / 18 ft  | 240 lbs / 18 ft | 90 lbs / 18 ft                  | n/a                        | 220 lbs / 20 ft                 |
| motor unit can be installed on either end of track   | X  | X               | X                               | X                          | X                               |
| inverse mounting of motor  |  |                 |                                 | X                          | X                               |
| factory reset  | X  | X               | X                               | X                          | X                               |
| Control Options  | BTX-DC-60  | BTX-DC-120      | BTX-DCS-45                      | Glydea® 35                 | Glydea® 60e                     |
| timer control  |  |                 |                                 | X                          | X                               |
| sun control  |  |                 |                                 | X                          | X                               |
| 3 normally open dry contacts   |  |                 |                                 | X                          | X                               |
| 2 normally open dry contacts   | X  | X               | X                               | X                          | X                               |
| 2 normally open dry contact sequencing mode  | Available with external control (RP Board)             |                 |                                 | X                          | X                               |
| dry contact individual and group master control  | X  | X               | X                               | X                          | X                               |
| digital technology   | RS232 interface  |                 |                                 | RS485 interface            |                                 |
| Solar Power  |  |                 | X                               |                            |                                 |
| Installation Features  | BTX-DC-60  | BTX-DC-120      | BTX-DCS-B-45                    | Glydea® 35                 | Glydea® 60e                     |
| programming buttons on motor unit  |  |                 |                                 | X                          | X                               |
| power supply   | 24V Transformer  | 24V Transformer | 5V Solar Panel                  | 120V                       |                                 |
| amperage   | 6A   | 1A              | <0.2**A                         | 0.5A                       | 1A                              |
| power consumption  | 15W  | 25W             | 20W                             | 60 W                       | 120 W                           |
| power cable type   | 3 conductor AC to transformer, 2 conductor DC to motor |                 | 2 conductor from motor to panel | 3-wire cable               | 3-wire cable                    |
| control connector type   | RJ-11  | RJ-11           | RJ-11                           | RJ-12                      | RJ-12                           |
| DCT control circuit voltage  |  |                 |                                 | 3.3 VDC                    | 3.3 VDC                         |
| certifications   | c UL US Listed, CE, CCC                                |                 |                                 | c TUV us, CCC, CE          |                                 |
| Standard Accessories <i>Included with system</i>   | BTX-DC-60  | BTX-DC-120      | BTX-DCS-45                      | Glydea® 35                 | Glydea® 60e                     |
| 5 channel transmitter (remote control: white)  |  |                 |                                 | X                          | X                               |
| 6 channel transmitter (remote control: white)  | X  | X               | X                               |                            |                                 |
| Carrier Features   | BTX-DC-60  | BTX-DC-120      | BTX-DCS-45                      | Glydea® 35                 | Glydea® 60e                     |
| bronze or gold pinch pleat carriers  | X  | X               | X                               |                            |                                 |
| white pinch pleat carriers   | X  | X               | X                               | X                          | X                               |
| white Ripplefold® style carriers compatible with Graber® Rollpleat tape (choose 80%, 100%, or 120% fullness) | X  | X               | X                               |                            |                                 |
| white Ripplefold® style carriers compatible with Kirsch Rollpleat® tape (choose 80%, 100%, or 120% fullness) | X  | X               | X                               | X                          | X                               |

\*components include: carriers, master carriers, drive gears, return hooks and fascia clips    \*\*maximum allowable charging current

# Motorized Traverse Systems

## Motorized Traverse System

### 4. Choose a carrier

#### Standard Pinch Pleat Carrier



Pinch pleat carriers  
4 per foot, unless otherwise specified

BTX DC Pinch Pleat

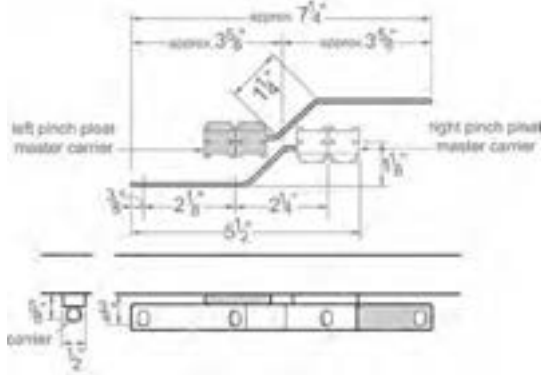

Somfy Glydea® Pinch Pleat

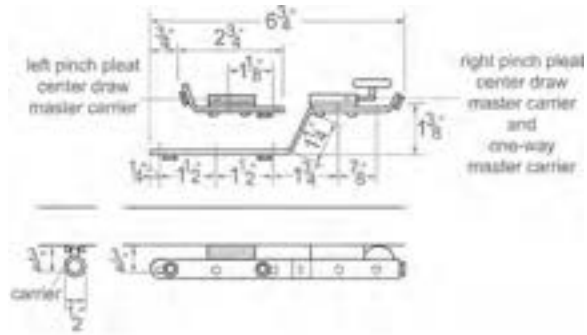

#### Ripplefold® Style Carrier



Ripplefold® style carriers  
80% carrier fullness: 2 3/8" spacing  
100% carrier fullness: 2 1/8" spacing  
120% carrier fullness: 1 7/8" spacing  
Snap tape: 4 1/4" spacing  
Snap tape not included with system

BTX DC Ripplefold® style

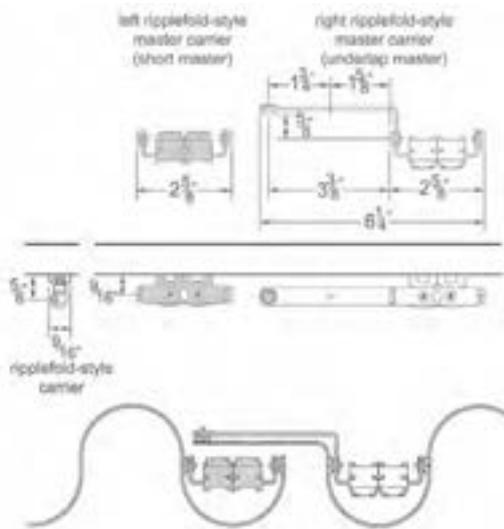

Somfy Glydea® Ripplefold® style

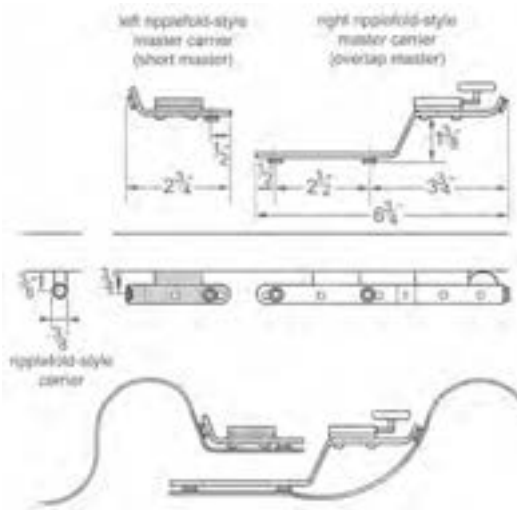

**Important:** Drapery workroom must apply specific snap tape to drapery panel when using Ripplefold® style carriers.  
BTX DC Ripplefold® style carriers are only compatible with Graber® Rollpleat snap tape or Kirsch Ripplefold® snap tape. Other brand snap tapes are NOT COMPATIBLE with the BTX DC Motorized system.  
Somfy Glydea® Ripplefold® style carriers are only compatible with Kirsch Ripplefold® snap tape. Other brand tapes are NOT COMPATIBLE with the Somfy Glydea® Motorized system.  
Graber is a registered trademark of Springs Window Fashions, Inc. Ripplefold is a registered trademark of Kirsch, Inc.

BTX DC Ripplefold® style



Somfy Glydea® Ripplefold® style

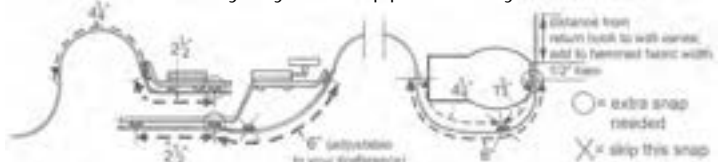



# Motorized Traverse System Information

|                             | 6' | 7' | 8' | 9' | 10' | 11' | 12' | 13' | 14' | 15' | 16' |
|-----------------------------|----|----|----|----|-----|-----|-----|-----|-----|-----|-----|
| Pinch Pleat Carriers        | 24 | 28 | 32 | 36 | 40  | 44  | 48  | 52  | 56  | 60  | 64  |
| Brackets                    | 3  | 3  | 4  | 4  | 4   | 5   | 5   | 5   | 6   | 6   | 6   |
| Portfolio Fascia Splices *  | 0  | 0  | 0  | 0  | 0   | 0   | 0   | 0   | 0   | 0   | 0   |
| Quick Ship Fascia Splices * | 0  | 0  | 0  | 0  | 0   | 0   | 0   | 1   | 1   | 1   | 1   |
| Track Splices*              | 0  | 0  | 0  | 0  | 0   | 0   | 0   | 0   | 0   | 0   | 0   |

\* track and fascia will be spliced in center of overall length  
 Standard carriers are 4 per foot  
 Standard brackets are 1 every 4 feet

## Wall Mount Brackets

BTX Single Motorized Bracket  
 Available in Gold, Bronze or White

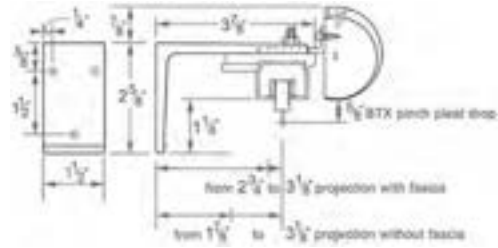

BTX Double Motorized Bracket  
 Available in Gold, Bronze or White

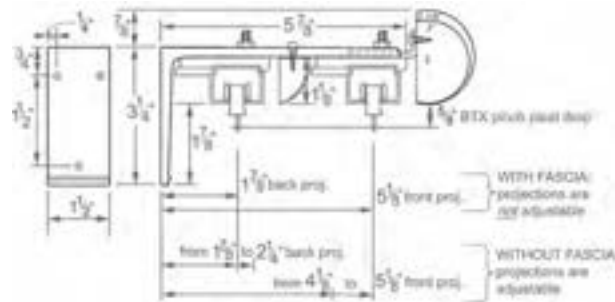

Somfy Single Motorized Bracket  
 Available in Gold, Bronze or White

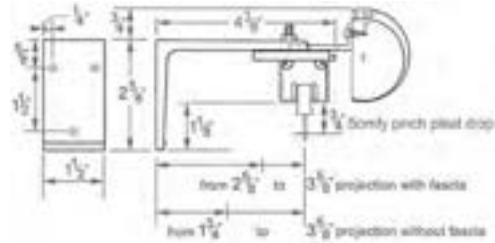

Somfy Double Motorized Bracket  
 Available in Gold, Bronze or White

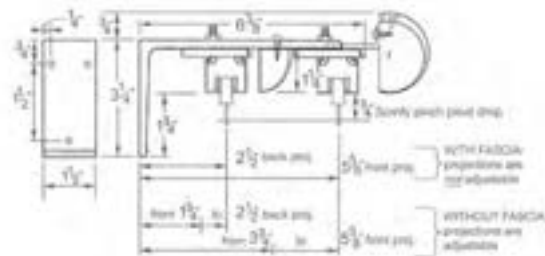

Motorized Over-Bracket  
 Portfolio and Quick Ship Wood and Resin finishes only.  
 Sold separately. Use with Single Motorized Track.

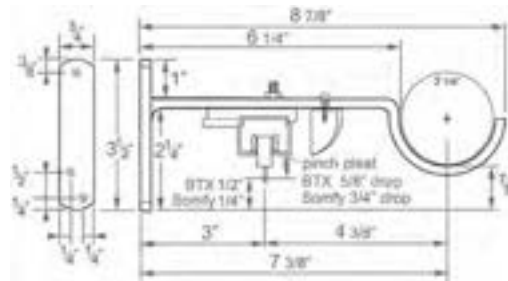

This bracket allows stationary panels on a full 2" or 2 1/4" dia wood pole in front of a single motorized traverse track.

Optional back fascia will be attached to Motorized Over-Bracket. Diagram depicts measurements when back fascia is desired.

## Ceiling Mount Brackets

BTX Ceiling Mount Bracket  
 Available in Gold, Bronze or White

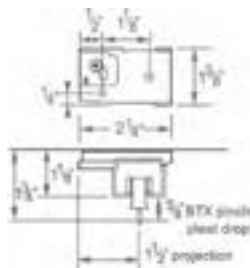

Somfy Ceiling Mount Bracket  
 Available in White only

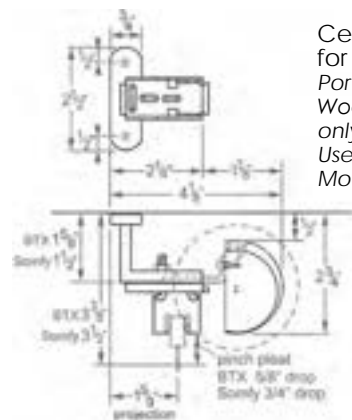
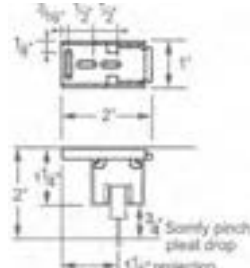

Ceiling Mount Bracket for System with Fascia  
 Portfolio and Quick Ship Wood and Resin finishes only. Sold separately. Use with Single Motorized Track.

Please note: only Ceiling Mount Bracket for System with Fascia will accommodate fascia and finials.

# Motorized Traverse Systems

## Motorized Traverse System Pricing

| Item # | Name | Price |  |  |  |  |  |  |
|--------|------|-------|--|--|--|--|--|--|
|--------|------|-------|--|--|--|--|--|--|

### Motorized Traverse System with Wood Fascia

| Single Track System with Wood Fascia  |  | 6'         | 7'         | 8'         | 9'         | 10'        | 11'        | 12'        |
|---|--|------------|------------|------------|------------|------------|------------|------------|
| BM01  | BTX-DC-60 Std Motor                      | DISCO      | DISCO      | DISCO      | DISCO      | DISCO      | DISCO      | DISCO      |
|   | BTX-DC-120 Heavy Duty Motor              | \$2,394.30 | \$2,485.15 | \$2,576.00 | \$2,666.85 | \$2,757.70 | \$2,848.55 | \$2,939.40 |
|   | BTX-DCS-45 Solar Motor                   | DISCO      | DISCO      | DISCO      | DISCO      | DISCO      | DISCO      | DISCO      |
| SM01  | Somfy Glydea® ULTRA 35e Std Motor        | \$2,349.45 | \$2,454.10 | \$2,558.75 | \$2,663.40 | \$2,768.05 | \$2,872.70 | \$2,977.35 |
|   | Somfy Glydea® ULTRA 60e Heavy Duty Motor | \$2,751.95 | \$2,856.60 | \$2,961.25 | \$3,065.90 | \$3,170.55 | \$3,275.20 | \$3,379.85 |
| Double Track System with Wood Fascia Front Only                                   |  |            |            |            |            |            |            |            |
| BM05  | BTX-DC-60 Std Motor                      | DISCO      | DISCO      | DISCO      | DISCO      | DISCO      | DISCO      | DISCO      |
|   | BTX-DC-120 Heavy Duty Motor              | \$4,595.40 | \$4,744.90 | \$4,894.40 | \$5,043.90 | \$5,193.40 | \$5,342.90 | \$5,492.40 |
|   | BTX-DCS-45 Solar Motor                   | DISCO      | DISCO      | DISCO      | DISCO      | DISCO      | DISCO      | DISCO      |
| SM05  | Somfy Glydea® ULTRA 35e Std Motor        | \$4,505.70 | \$4,681.65 | \$4,857.60 | \$5,033.55 | \$5,209.50 | \$5,385.45 | \$5,561.40 |
|   | Somfy Glydea® ULTRA 60e Heavy Duty Motor | \$5,310.70 | \$5,486.65 | \$5,662.60 | \$5,838.55 | \$6,014.50 | \$6,190.45 | \$6,366.40 |
| Double Track System with Wood Fascia Front and Back                               |  |            |            |            |            |            |            |            |
| BM09  | BTX-DC-60 Std Motor                      | DISCO      | DISCO      | DISCO      | DISCO      | DISCO      | DISCO      | DISCO      |
|   | BTX-DC-120 Heavy Duty Motor              | \$4,698.90 | \$4,865.65 | \$5,032.40 | \$5,199.15 | \$5,365.90 | \$5,532.65 | \$5,699.40 |
|   | BTX-DCS-45 Solar Motor                   | DISCO      | DISCO      | DISCO      | DISCO      | DISCO      | DISCO      | DISCO      |
| SM09  | Somfy Glydea® ULTRA 3e5 Std Motor        | \$4,609.20 | \$4,802.40 | \$4,995.60 | \$5,188.80 | \$5,382.00 | \$5,575.20 | \$5,768.40 |
|   | Somfy Glydea® ULTRA 60e Heavy Duty Motor | \$5,414.20 | \$5,607.40 | \$5,800.60 | \$5,993.80 | \$6,187.00 | \$6,380.20 | \$6,573.40 |
| Double System with Wood Fascia on Back Track and Full Stationary Pole on Front    |  |            |            |            |            |            |            |            |
| BM23  | BTX-DC-60 Std Motor                      | DISCO      | DISCO      | DISCO      | DISCO      | DISCO      | DISCO      | DISCO      |
|   | BTX-DC-120 Heavy Duty Motor              | \$2,653.05 | \$2,801.40 | \$2,949.75 | \$3,098.10 | \$3,246.45 | \$3,394.80 | \$3,543.15 |
|   | BTX-DCS-45 Solar Motor                   | DISCO      | DISCO      | DISCO      | DISCO      | DISCO      | DISCO      | DISCO      |
| SM23  | Somfy Glydea® ULTRA 35e Std Motor        | \$2,608.20 | \$2,770.35 | \$2,932.50 | \$3,094.65 | \$3,256.80 | \$3,418.95 | \$3,581.10 |
|   | Somfy Glydea® ULTRA 60e Heavy Duty Motor | \$3,010.70 | \$3,172.85 | \$3,335.00 | \$3,497.15 | \$3,659.30 | \$3,821.45 | \$3,983.60 |
| Double System without Wood Fascia on Back Track and Full Stationary Pole on Front |  |            |            |            |            |            |            |            |
| BM21  | BTX-DC-60 Std Motor                      | DISCO      | DISCO      | DISCO      | DISCO      | DISCO      | DISCO      | DISCO      |
|   | BTX-DC-120 Heavy Duty Motor              | \$2,563.35 | \$2,696.75 | \$2,830.15 | \$2,963.55 | \$3,096.95 | \$3,230.35 | \$3,363.75 |
|   | BTX-DCS-45 Solar Motor                   | DISCO      | DISCO      | DISCO      | DISCO      | DISCO      | DISCO      | DISCO      |
| SM21  | Somfy Glydea® ULTRA 35e Std Motor        | \$2,518.50 | \$2,665.70 | \$2,812.90 | \$2,960.10 | \$3,107.30 | \$3,254.50 | \$3,401.70 |
|   | Somfy Glydea® ULTRA 60e Heavy Duty Motor | \$2,921.00 | \$3,068.20 | \$3,215.40 | \$3,362.60 | \$3,509.80 | \$3,657.00 | \$3,804.20 |

### Motorized Traverse System without Wood Fascia

| Single Track System |  | 6'         | 7'         | 8'         | 9'         | 10'        | 11'        | 12'        |
|---------------------|--|------------|------------|------------|------------|------------|------------|------------|
| BM13                | BTX-DC-60 Std Motor                      | DISCO      | DISCO      | DISCO      | DISCO      | DISCO      | DISCO      | DISCO      |
|                     | BTX-DC-120 Heavy Duty Motor              | \$2,201.10 | \$2,259.75 | \$2,318.40 | \$2,377.05 | \$2,435.70 | \$2,494.35 | \$2,553.00 |
|                     | BTX-DCS-45 Solar Motor                   | DISCO      | DISCO      | DISCO      | DISCO      | DISCO      | DISCO      | DISCO      |
| SM13                | Somfy Glydea® ULTRA 35e Std Motor        | \$2,156.25 | \$2,228.70 | \$2,301.15 | \$2,373.60 | \$2,446.05 | \$2,518.50 | \$2,590.95 |
|                     | Somfy Glydea® ULTRA 60e Heavy Duty Motor | \$2,558.75 | \$2,631.20 | \$2,703.65 | \$2,776.10 | \$2,848.55 | \$2,921.00 | \$2,993.45 |
| Double Track System |  |            |            |            |            |            |            |            |
| BM15                | BTX-DC-60 Std Motor                      | DISCO      | DISCO      | DISCO      | DISCO      | DISCO      | DISCO      | DISCO      |
|                     | BTX-DC-120 Heavy Duty Motor              | \$4,402.20 | \$4,519.50 | \$4,636.80 | \$4,754.10 | \$4,871.40 | \$4,988.70 | \$5,106.00 |
|                     | BTX-DCS-45 Solar Motor                   | DISCO      | DISCO      | DISCO      | DISCO      | DISCO      | DISCO      | DISCO      |
| SM15                | Somfy Glydea® ULTRA 35e Std Motor        | \$4,312.50 | \$4,457.40 | \$4,602.30 | \$4,747.20 | \$4,892.10 | \$5,037.00 | \$5,181.90 |
|                     | Somfy Glydea® ULTRA 60e Heavy Duty Motor | \$5,117.50 | \$5,262.40 | \$5,407.30 | \$5,552.20 | \$5,697.10 | \$5,842.00 | \$5,986.90 |

• For Ripplefold® style upgrade, please add 10% to the value of Traverse System order.



| 13'        | 14'        | 15'        | 16'        | per add'l ft |
|------------|------------|------------|------------|--------------|
| DISCO      | DISCO      | DISCO      | DISCO      | DISCO        |
| \$3,030.25 | \$3,121.10 | \$3,211.95 | \$3,302.80 | \$90.85      |
| DISCO      | DISCO      | DISCO      | DISCO      | DISCO        |
| \$3,082.00 | \$3,186.65 | \$3,291.30 | \$3,395.95 | \$104.65     |
| \$3,484.50 | \$3,589.15 | \$3,693.80 | \$3,798.45 | \$104.65     |
| DISCO      | DISCO      | DISCO      | DISCO      | DISCO        |
| \$5,641.90 | \$5,791.40 | \$5,940.90 | \$6,090.40 | \$149.50     |
| DISCO      | DISCO      | DISCO      | DISCO      | DISCO        |
| \$5,737.35 | \$5,913.30 | \$6,089.25 | \$6,265.20 | \$175.95     |
| \$6,542.35 | \$6,718.30 | \$6,894.25 | \$7,070.20 | \$175.95     |
| DISCO      | DISCO      | DISCO      | DISCO      | DISCO        |
| \$5,866.15 | \$6,032.90 | \$6,199.65 | \$6,366.40 | \$166.75     |
| DISCO      | DISCO      | DISCO      | DISCO      | DISCO        |
| \$5,961.60 | \$6,154.80 | \$6,348.00 | \$6,541.20 | \$193.20     |
| \$6,766.60 | \$6,959.80 | \$7,153.00 | \$7,346.20 | \$193.20     |
| DISCO      | DISCO      | DISCO      | DISCO      | DISCO        |
| \$3,691.50 | \$3,839.85 | \$3,988.20 | \$4,136.55 | \$148.35     |
| DISCO      | DISCO      | DISCO      | DISCO      | DISCO        |
| \$3,743.25 | \$3,905.40 | \$4,067.55 | \$4,229.70 | \$162.15     |
| \$4,145.75 | \$4,307.90 | \$4,470.05 | \$4,632.20 | \$162.15     |
| DISCO      | DISCO      | DISCO      | DISCO      | DISCO        |
| \$3,497.15 | \$3,630.55 | \$3,763.95 | \$3,897.35 | \$133.40     |
| DISCO      | DISCO      | DISCO      | DISCO      | DISCO        |
| \$3,548.90 | \$3,696.10 | \$3,843.30 | \$3,990.50 | \$147.20     |
| \$3,951.40 | \$4,098.60 | \$4,245.80 | \$4,393.00 | \$147.20     |

| 13'        | 14'        | 15'        | 16'        | per add'l ft |
|------------|------------|------------|------------|--------------|
| DISCO      | DISCO      | DISCO      | DISCO      | DISCO        |
| \$2,611.65 | \$2,670.30 | \$2,728.95 | \$2,787.60 | \$58.65      |
| DISCO      | DISCO      | DISCO      | DISCO      | DISCO        |
| \$2,663.40 | \$2,735.85 | \$2,808.30 | \$2,880.75 | \$72.45      |
| \$3,065.90 | \$3,138.35 | \$3,210.80 | \$3,283.25 | \$72.45      |
| DISCO      | DISCO      | DISCO      | DISCO      | DISCO        |
| \$5,223.30 | \$5,340.60 | \$5,457.90 | \$5,575.20 | \$117.30     |
| DISCO      | DISCO      | DISCO      | DISCO      | DISCO        |
| \$5,326.80 | \$5,471.70 | \$5,616.60 | \$5,761.50 | \$144.90     |
| \$6,131.80 | \$6,276.70 | \$6,421.60 | \$6,566.50 | \$144.90     |

| Item # | Name | Color | Price |
|--------|------|-------|-------|
|--------|------|-------|-------|

### BTX Motors

|          |                               |  |            |
|----------|-------------------------------|--|------------|
| 101.9010 | BTX-DC-60 Std Motor *         |  | DISCO      |
| 101.9020 | BTX-DC-120 Heavy Duty Motor * |  | \$1,035.00 |
| 102.9000 | BTX-DCS-45 Solar Motor **     |  | DISCO      |

\* Transformer is included

\*\* Solar panel is included

### BTX Accessories

#### Transmitters/Devices

|          |                                      |       |          |
|----------|--------------------------------------|-------|----------|
| 490.2076 | BTX DC Std Transmitter (6 channel)   | White | \$172.50 |
| 480.3040 | BTX Wireless Wall Switch (1 channel) | White | \$172.50 |
| 480.3045 | BTX Wireless Wall Switch (2 channel) | White | \$230.00 |

#### Carrier

|         |                             |            |        |
|---------|-----------------------------|------------|--------|
| MOSPPCB | BTX Std Pinch Pleat Carrier | WH, GO, BR | \$2.88 |
|---------|-----------------------------|------------|--------|

#### Brackets

|             |  |                                   |         |
|-------------|--|-----------------------------------|---------|
| HDTB35-B    | BTX Single Bracket                           | WH, GO, BR                        | \$28.75 |
| HDTB-B      | BTX Double Bracket                           | WH, GO, BR                        | \$33.35 |
| PO214MCBKB  | Ceiling Mount Bracket for system with Fascia | Portfolio and Quick Ship finishes | \$56.10 |
| PO214MOCBKB | Motorized Over-Bracket                       | Portfolio and Quick Ship finishes | \$71.50 |
| MOCMBKB     | BTX Ceiling Mount Bracket                    | White                             | \$11.50 |

### BTX Additional Fees

|   |          |
|---|----------|
| Curving Fee (per bend; template must be provided) | \$175.00 |
| Handling and crating fee for curved tracks        | \$75.00  |

### Somfy & BTX Additional Options & Upgrades

Ripplefold® style upgrade 10% system upcharge

|      |                                   |             |
|------|-----------------------------------|-------------|
| MO61 | Blended fascia splice per splice  | \$75.00 Net |
| MO57 | Miter cuts 3 5/8" return per pair | \$50.00 Net |
| MO58 | Miter cuts 5 5/8" return per pair | \$50.00 Net |
|      | Packaging fee per order           | \$25.00 Net |

## Motorized Traverse Systems

# Motorized Traverse System Pricing con't.

| Item # | Name | Color | Price |
|--------|------|-------|-------|
|--------|------|-------|-------|

### Somfy Motors

|         |  |  |            |
|---------|--|--|------------|
| 1003152 | Somfy Glydea® ULTRA 35e Std Motor        |  | \$1,132.75 |
| 1003159 | Somfy Glydea® ULTRA 60e Heavy Duty Motor |  | \$1,380.00 |

### Somfy Accessories

#### Transmitters/Devices

|         |                                |        |          |
|---------|--------------------------------|--------|----------|
| 1810633 | Standard Transmitter-5 channel | White  | \$258.75 |
| 1810641 | Transmitter-5 channel          | Silver | \$373.75 |
| 1810652 | Transmitter-5 channel          | Black  | \$373.75 |
| 1810632 | Transmitter-1 channel          | White  | \$201.25 |
| 1810639 | Transmitter-1 channel          | Silver | \$299.00 |
| 1810650 | Transmitter-1 channel          | Black  | \$299.00 |
| 1811081 | Transmitter-16 channel         | White  | \$787.75 |
| 1811082 | Transmitter-16 channel         | Silver | \$862.50 |
| 1810897 | Wireless Wall Switch-1 channel | White  | \$442.75 |
| 1810898 | Wireless Wall Switch-1 channel | Ivory  | \$442.75 |
| 1810899 | Wireless Wall Switch-1 channel | Black  | \$506.00 |
| 1811180 | Wireless Wall Switch-1 channel | Almond | \$442.75 |
| 1810813 | Wireless Wall Switch-5 channel | White  | \$460.00 |
| 1810814 | Wireless Wall Switch-5 channel | Ivory  | \$460.00 |
| 1810830 | Wireless Wall Switch-5 channel | Black  | \$534.75 |
| 1811181 | Wireless Wall Switch-5 channel | Almond | \$460.00 |
| 1811185 | Table Top Accessory *          | White  | \$138.00 |
| 1810972 | Table Top Accessory *          | Silver | \$138.00 |
| 1811051 | Table Top Accessory *          | Black  | \$138.00 |

\* use with Wireless Wall Switch

| Item # | Name | Color | Price |
|--------|------|-------|-------|
|--------|------|-------|-------|

### Somfy Accessories con't.

#### Programmable Timers

|         |                          |        |          |
|---------|--------------------------|--------|----------|
| 1805217 | Handheld Timer-6 channel | White  | \$902.75 |
| 1805218 | Handheld Timer-6 channel | Silver | \$920.00 |
| 1805176 | Wall Mount Timer         | Almond | \$621.00 |
| 9013707 | Sunis Indoor Sun Control | Almond | \$678.50 |

#### Carrier

|         |                               |       |        |
|---------|-------------------------------|-------|--------|
| MOSPPCS | Somfy Std Pinch Pleat Carrier | White | \$2.88 |
|---------|-------------------------------|-------|--------|

#### Brackets

|             |   |                                   |         |
|-------------|---|-----------------------------------|---------|
| HDTB35-S    | Somfy Single Bracket                          | WH, GO, BR                        | \$24.15 |
| HDTB-S      | Somfy Double Bracket                          | WH, GO, BR                        | \$33.35 |
| PO214MCBKS  | Ceiling Mount Bracket for Systems with Fascia | Portfolio and Quick Ship finishes | \$58.65 |
| PO214MOCBKS | Motorized Over-Bracket                        | Portfolio and Quick Ship finishes | \$71.50 |
| MOCMBKS     | Somfy Ceiling Mount Bracket                   | White                             | \$11.50 |

### Somfy Additional Fees

|   |        |
|---|--------|
| Curving Fee (per bend; template must be provided) | Quoted |
|---|--------|

## PTH Motorized Traverse Tips

- Specified custom cut length indicates track length including drive gears; fascia will be 1/4" longer at each end of track (1/2" total); mitered fascia will be 1 1/2" longer at each end of track (3" total).
- Track and fascia will be spliced in the center of overall length.
- Blended fascia is available for an additional fee per blend; PTH will properly connect splice(s) and ship your fascia in one continuous length.
- Back fascia can accommodate decorative end caps; decorative end caps sold separately.
- Both BTX and Somfy Motorized Traverse Systems carry a 5 year warranty; WARNING: Modifications of internal components will void BTX and Somfy warranties.

## Motorized Stack Back Calculation (each drapery panel)

BTX: master carrier + (# carriers on panel x carrier width) + 3.375" = stack per drapery panel

Somfy: master carrier + (# carriers on panel x carrier width) + 3.75" = stack per drapery panel

Ex: Somfy 10ft. center draw, pinch pleat (standard 4 carriers per ft.)

2.75" + [(40/2) x .5"] + 3.75" = 16.5" stack, short master panel *BEFORE* drapery fabric is installed

6.75" + [(40/2) x .5"] + 3.75" = 20.5" stack, overlap master panel *BEFORE* drapery fabric is installed



Ex: BTX 20 ft. one-way draw, Ripplefold® style 80% fullness

6.25" + (98 x .563") + 3.375" = 64.79" stack, underlap master panel *BEFORE* drapery fabric is installed

**Please note:** Calculations result in stack back width *BEFORE* drapery fabric is installed. Stack back width will increase once draperies are installed. Factors such as thickness of drapery fabric, type of drapery pleat, and fullness of treatment affect the final stack back width. Please consult your workroom to determine your final stack back based on your draperies.

## Quick Ship 1" Modern Metal Finials fit the 1" metal pole, but DO NOT fit the 1" Hand Drawn Traverse System.

|   |   |   |  |   |   |
|---|---|---|--|---|---|
|  |  |  |       |  |  |
| QS100COFI<br>Cole<br>3¼" (8.3 cm) W<br>1½" (3.8 cm) DIA<br>\$66.00 pair*          | QS100ELAFI<br>Ella<br>1½" (3.8 cm) W<br>1⅝" (4.1 cm) DIA<br>\$55.00 pair*         | QS100EMFI<br>Elm<br>1½" (2.9 cm) W<br>2" (5.1 cm) DIA<br>\$55.00 pair*            | QS100EMFIGL<br>Elm - Smoke Glass<br>1½" (2.9 cm) W<br>2" (5.1 cm) DIA<br>\$66.00 pair* | QS100KNFI<br>Knox - Crystal<br>1¼" (3.2 cm) W<br>2¼" (5.7 cm) DIA<br>\$88.00 pair*  | QS100LXFI<br>Lex<br>1¾" (4.4 cm) W<br>2" (5.1 cm) DIA<br>\$44.00 pair*              |

|   |   |  |
|---|---|--|
|  |  |           |
| QS100LUEC<br>Luna End Cap<br>¾" (1.9 cm) W<br>1¼" (3.2 cm) DIA<br>\$22.00 pair*   | QS100NOFI<br>Nora<br>2" (5.1 cm) W<br>2¼" (5.7 cm) DIA<br>\$77.00 pair*           | QS100NOFIGL<br>Nora - Mercury Glass<br>2⅝" (5.4 cm) W<br>2¾" (6.0 cm) DIA<br>\$88.00 pair* |

*Luna End Cap covers ⅝" (1.6 cm) of end of pole: functional pole length may need to be lengthened accordingly.*

## Quick Ship 1" Modern Metal Finial Accessory:



QS100CRMEBAND  
1" Crystal Band  
⅝" (1.6 cm) W  
1½" (2.7 cm) ID  
1⅝" (4.1 cm) OD

- metal; available only in dark metal with inlaid crystals
- not recommended for 1" Hand Drawn Traverse System
- covers ⅝" of pole

\$33.00 ea

Dress up your Modern Finial: Add a 1" Crystal Band.

These 1" Bands can be used on a 1" pole in 2 ways:

- against the base of a 1" finial for a touch of glamour
- anywhere on the 1" pole for additional decoration

### How To Add Your Bling:

-  Buy a pair of 1" Modern Finials.
-  Buy two 1" Crystal Bands.
-  Slide each 1" Crystal Band onto the pole before installing finials.
-  Install finials. Slide Crystal Bands against finials and tighten set screws.







\*Sold in pairs only.

# Quick Ship Metal 1"

Available in all 5 Quick Ship Metal finishes.

## Quick Ship 1" Transitional Metal Finials

fit the 1" metal pole and the 1" Hand Drawn Traverse System.  
 Note: Transitional Metal Finial covers  $\frac{5}{8}$ " (1.6 cm) of pole or track; finished pole length may need to be increased accordingly.





|   |   |   |   |   |   |
|---|---|---|---|---|---|
|  |  |  |  |  |  |
| QS100COFICU   | QS100ELAFICU  | QS100EMFICU   | QS100EMFIGLCU   | QS100KNFICU   | QS100LXFICU   |
| Cole with 1" Cuff   | Ella with 1" Cuff   | Elm with 1" Cuff  | Elm - Smoke Glass with 1" Cuff  | Knox - Crystal with 1" Cuff   | Lex with 1" Cuff  |
| 4" (10.2 cm) W<br>1½" (3.8 cm) DIA  | 2¼" (5.7 cm) W<br>1⅝" (4.1 cm) DIA  | 1⅞" (4.8 cm) W<br>2" (5.1 cm) DIA   | 1⅞" (4.8 cm) W<br>2" (5.1 cm) DIA   | 2" (5.1 cm) W<br>2¼" (5.7 cm) DIA   | 2½" (6.4 cm) W<br>2" (5.1 cm) DIA   |
| \$82.50 pair*   | \$71.50 pair*   | \$71.50 pair*   | \$82.50 pair*   | \$104.50 pair*  | \$60.50 pair*   |

|   |   |   |
|---|---|---|
|  |  |  |
| QS100LUEC   | QS100NOFICU   | QS100NOFIGLCU   |
| Luna End Cap  | Nora with 1" Cuff   | Nora - Mercury Glass with 1" Cuff   |
| ¾" (1.9 cm) W<br>1¼" (3.2 cm) DIA   | 2¾" (7.0 cm) W<br>2¼" (5.7 cm) DIA  | 2⅞" (7.3 cm) W<br>2⅝" (6.0 cm) DIA  |
| \$22.00 pair*   | \$93.50 pair*   | \$104.50 pair*  |

### Refine your Transitional Finial: Add a Traditional Collar.

(maintains compatibility with the 1" Hand Drawn Traverse System)

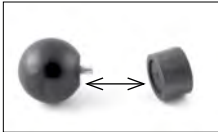
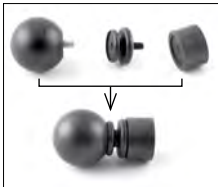
### How To Make It Traditional:

-  Buy a pair of 1" Transitional Finials.
-  Buy a pair of Traditional Collars.
-  Unscrew the finial from its Cuff.
-  Screw finial into the Traditional Collar. Screw Traditional Collar into the Cuff.
-  Attach the finial to the end of the pole by tightening the set screw on the Cuff.

## Quick Ship 1" Transitional Metal Finial Accessory:

|   |
|---|
|    |
| QSTRADCO  |
| Traditional Collar  |
| $\frac{5}{8}$ " (1.6 cm) W<br>1⅞" (2.9 cm) DIA  |
| <ul style="list-style-type: none"> <li>metal; available in any Quick Ship Metal finish</li> <li>can only be added to Transitional Metal finials</li> <li>installs between the Finial and 1" Cuff</li> <li>adding Traditional Collar increases width of finial by <math>\frac{5}{8}</math>" (1.6cm)</li> </ul> |
| \$22.00 pair*   |

\*Sold in pairs only.

## Quick Ship 1" Cuff AVAILABLE IN CONTRASTING FINISH.



QS100CUFF

1" Cuff

¾" (1.9 cm) W  
1¼" (3.2 cm) DIA

- metal; available in all 5 Quick Ship Metal finishes
- covers 5/8" of the pole; finished length may need to be increased accordingly.

\$22.00 pair\*

Looking for a 1" Cuff in Brushed Nickel to accessorize your 1" Portfolio Finial?

1" Cuff is only compatible with the following Portfolio 1" Finials:



- 1" Textured Metal Finials
- 1" Glamour Resin Finials
- 1" California Resin Finials
- 1" Tried & True Resin Finials

Note: The Traditional Collar can be purchased in Brushed Nickel on page 58.

## Quick Ship 1" Metal Holdbacks

**Metal Holdbacks** Include Metal Holdback Stems.

Note: STEMS ARE INCLUDED, AND A PROJECTION OF 2", 4", OR 6" MUST BE SELECTED. Projection indicates distance from wall to back of medallion.

|   |          |               |  |                |                                |
|---|----------|---------------|--|----------------|--------------------------------|
| <br>Blake - Mercury Glass | QSBKHB2  | 2" Projection | METAL AND GLASS<br>3" (7.6 cm) DIA x<br>2⅝" (6.0 cm) THICK | \$132.00 pair* | <i>Must select projection.</i> |
|   | QSBKHB4  | 4" Projection |  |                |                                |
|   | QSBKHB6  | 6" Projection |  |                |                                |
| <br>Jem                  | QSJEHB2  | 2" Projection | METAL<br>2½" (6.4 cm) DIA x<br>¾" (1.0 cm) THICK           | \$71.50 pair*  | <i>Must select projection.</i> |
|   | QSJEHB4  | 4" Projection |  |                |                                |
|   | QSJEHB6  | 6" Projection |  |                |                                |
| <br>Mara                 | QSMARHB2 | 2" Projection | METAL<br>3" (7.6 cm) DIA x<br>7/8" (2.2 cm) THICK          | \$104.50 pair* | <i>Must select projection.</i> |
|   | QSMARHB4 | 4" Projection |  |                |                                |
|   | QSMARHB6 | 6" Projection |  |                |                                |

### Metal Holdback Stems

Base: 2" DIA  
Stem: ½" DIA  
Rose Gold

2", 4", or 6" projection must be selected.

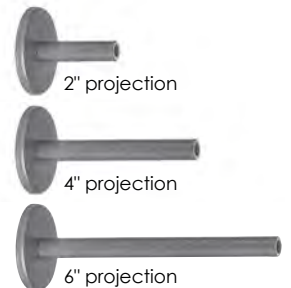





\*Sold in pairs only.

# Quick Ship Metal 1"

Available in all 5 Quick Ship Metal finishes.

## Quick Ship 1" Brackets fit the 1" pole.

Note: Bracket return indicates distance from wall to center of pole. Bracket projection indicates distance from wall to back of pole.

|  |  |  |   |  |
|--|--|--|---|--|
|  <p><b>QS100MCMBK</b><br/>1" Metal Ceiling Mount</p> <p>2" (5.1 cm) W x<br/>2 1/4" (5.7 cm) H x<br/>2" (5.1 cm) D;</p> <hr/> <p>Base: 2" (5.1 cm) DIA<br/>Cradle: 1" (2.5 cm) W x<br/>1 1/4" (3.2 cm) OD x<br/>1 1/8" (2.9 cm) ID</p> <hr/> <p>Drop (distance from ceiling to bottom of pole): 2 1/8" (5.4 cm)</p> <p><b>\$27.50 ea</b></p> |  <p><b>QS100MIBK</b><br/>1" Metal Inside Mount</p> <p>3/4" (1.9 cm) W x<br/>1 1/8" (2.9 cm) H x<br/>1 5/8" (4.1 cm) D</p> <p><b>\$55.00 pair*</b></p> | <p><i>Note: Pair includes right and left (set screw located in back when installed)</i></p>  <p><b>QS100LASBK</b><br/>Laurence 3" Single</p> <p>METAL<br/>3/4" (1.9 cm) W x<br/>3 3/4" (9.5 cm) H x<br/>4 1/8" (10.5 cm) D;</p> <hr/> <p>3 1/2" (8.9 cm) RET,<br/>3" (7.6 cm) PROJ</p> <p><b>\$33.00 ea</b></p> |  <p><b>QS100LAS6BK</b><br/>Laurence 6" Single</p> <p>METAL<br/>3/4" (1.9 cm) W x<br/>3 3/4" (9.5 cm) H x<br/>6 3/4" (17.1 cm) D;</p> <hr/> <p>6" (15.2 cm) RET,<br/>5 1/2" (14.0 cm) PROJ</p> <p><b>\$38.50 ea</b></p> |  <p><b>QS100LADBK</b><br/>Laurence 6" Double</p> <p>METAL<br/>3/4" (1.9 cm) W x<br/>3 3/4" (9.5 cm) H x<br/>6 3/4" (17.1 cm) D;</p> <hr/> <p>6" (15.2 cm) FRONT RET,<br/>3" (7.6 cm) BACK RET;<br/>5 1/2" (14.0 cm) FRONT PROJ,<br/>2 1/2" (6.4 cm) BACK PROJ</p> <hr/> <p>Both Cradles hold 1" pole</p> <p><b>\$38.50 ea</b></p> |
|--|--|--|---|--|

## Quick Ship 1" Rings fit the 1" pole.

Note: Ring drop indicates distance from bottom of pole to bottom of ring.

|   |
|---|
|  <p><b>QS100MRI</b><br/>1" Metal Ring</p> <p>METAL<br/>3/16" (0.5 cm) W<br/>1 1/2" (3.8 cm) ID<br/>1 7/8" (4.8 cm) OD,<br/>3/4" (1.9 cm) DROP</p> <p><b>\$5.50 ea</b></p> |
|---|

\*Sold in pairs only.



## Quick Ship 1" Smooth Metal Poles

Note: All orders with poles and/or traverse track will incur a \$10.00 packaging fee per order.

|            |            |            |            |             |             |
|------------|------------|------------|------------|-------------|-------------|
| QS100SM02  | QS100SM04  | QS100SM06  | QS100SM08  | QS100SM10   | QS100SM12   |
| 2'         | 4'         | 6'         | 8'         | 10'         | 12'         |
| \$24.20 ea | \$48.40 ea | \$72.60 ea | \$96.80 ea | \$121.00 ea | \$145.20 ea |

## Quick Ship 1" Accessories

Note: Hinged Resin Elbow available in all 5 Quick Ship Metal finishes.

|  |   |   |
|--|---|---|
|                     |  |  |
| <b>QS100REL</b><br>1" Hinged Resin Elbow   | <b>QSAC36WAND</b><br>36" Clear Acrylic Wand                                       | <b>QSAC48WAND</b><br>48" Clear Acrylic Wand                                       |
| 1 1/8" (2.9 cm) DIA<br>3/4" (8.3 cm)<br>TOTAL LENGTH<br><hr/> 1 3/8" (4.1 cm) each side<br>when bent | ACRYLIC, CLEAR ONLY<br>1/2" (1.3 cm) DIA x<br>36" (91.4 cm) LENGTH                | ACRYLIC, CLEAR ONLY<br>1/2" (1.3 cm) DIA x<br>48" (121.9 cm) LENGTH               |
| <b>\$27.50 ea</b>  | <b>\$44.00 ea</b>   | <b>\$49.50 ea</b>   |

\*Sold in pairs only.

# Quick Ship Metal 1"

Available in all 5 Quick Ship Metal finishes.

## Quick Ship 1" Hand Drawn Traverse System RECOMMENDED FOR LIGHTWEIGHT DRAPERIES

All orders with poles and/or traverse track will incur a \$10.00 packaging fee per order.

### Quick Ship 1" Hand Drawn Traverse System INCLUDES:

- Track(s): Continuous track available up to 8'; spliced lengths available up to 16'.
- Brackets
- Components: Glides and Glide Stop(s)\*
- 48" Clear Acrylic Wand(s)\*

**\*Note:** Each Center Draw Track includes 2 Glide Stops and 2 Acrylic Wands. Each One-Way Draw Track includes 1 Glide Stop and 1 Acrylic Wand.

### Finials sold separately.

- Transitional Finials must be ordered with all 1" Hand Drawn Traverse Systems.
- Only 1" Transitional Metal Finials can attach to the track.
- If a Traditional Collar is added to the 1" Transitional Finial, it will still fit the track.

Maximum drapery weight - 2 lbs/ft.

Available in 5 Quick Ship Metal finishes.

## Order in 3 Easy Steps:

### Step 1: Select your Draw.

### Step 2: Select your Bracket.

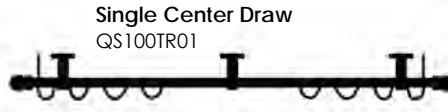

Single Center Draw  
QS100TR01

**Available Brackets**  
3½" Single  
6" Single  
Ceiling Mount

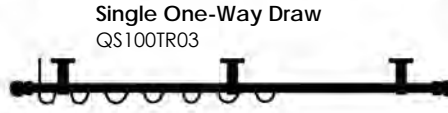

Single One-Way Draw  
QS100TR03

**Available Brackets**  
3½" Single  
6" Single  
Ceiling Mount

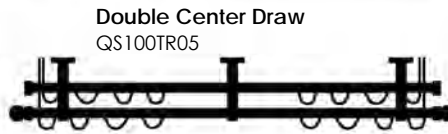

Double Center Draw  
QS100TR05

**Available Brackets**  
Double Bracket  
Ceiling Mount



Double One-Way Draw  
QS100TR07

**Available Brackets**  
Double Bracket  
Ceiling Mount

### Step 3: Purchase your Finials, sold separately.

**Single Center Draw** Includes: 1 track, single brackets (1 per 3-4 feet), glides (4 per foot), 2 glide stops, and 2 clear acrylic wands.  
**Must specify type of bracket.**

Track available in 8 ft continuous lengths only.  
Any track length over 8 ft must be spliced together.

|           | 2'       | 4'       | 6'       | 8'       | 10'      | 12'      | 14'      | 16'      |
|-----------|----------|----------|----------|----------|----------|----------|----------|----------|
| QS100TR01 | \$110.00 | \$220.00 | \$330.00 | \$440.00 | \$550.00 | \$660.00 | \$770.00 | \$880.00 |

**Single One-way Draw** Includes: 1 track, single brackets (1 per 3-4 feet), glides (4 per foot), 1 glide stop, and 1 clear acrylic wand.  
**Must specify type of bracket.**

|           | 2'       | 4'       | 6'       | 8'       | 10'      | 12'      | 14'      | 16'      |
|-----------|----------|----------|----------|----------|----------|----------|----------|----------|
| QS100TR03 | \$110.00 | \$220.00 | \$330.00 | \$440.00 | \$550.00 | \$660.00 | \$770.00 | \$880.00 |

**Double Center Draw** Includes: 2 tracks, double brackets (1 per 3-4 feet), glides (4 per foot), 4 glide stops, and 4 clear acrylic wands.  
**Must specify type of bracket.**

|           | 2'       | 4'       | 6'       | 8'       | 10'        | 12'        | 14'        | 16'        |
|-----------|----------|----------|----------|----------|------------|------------|------------|------------|
| QS100TR05 | \$220.00 | \$440.00 | \$660.00 | \$880.00 | \$1,100.00 | \$1,220.00 | \$1,440.00 | \$1,660.00 |

**Double One-way Draw** Includes: 2 tracks, double brackets (1 per 3-4 feet), glides (4 per foot), 2 glide stops, and 2 clear acrylic wands.  
**Must specify type of bracket.**

|           | 2'       | 4'       | 6'       | 8'       | 10'        | 12'        | 14'        | 16'        |
|-----------|----------|----------|----------|----------|------------|------------|------------|------------|
| QS100TR07 | \$220.00 | \$440.00 | \$660.00 | \$880.00 | \$1,100.00 | \$1,220.00 | \$1,440.00 | \$1,660.00 |





\*Sold in pairs only.

\*Sold in pairs only.

### Included in System: 1" Hand Drawn Traverse Brackets

Note: Brackets must be installed every 3 - 4 feet. Bracket return indicates distance from wall to center of track. Bracket projection indicates distance from wall to back of track. See System Quantity Chart for quantity of Brackets included with each system. Additional Brackets may be ordered separately.

Bracket style must be specified on your order.

|   |   |  |   |
|---|---|--|---|
|    |    |   |   |
| <b>QS100TRSBK</b><br>1" Traverse<br>3½" Single  | <b>QS100TRS6BK</b><br>1" Traverse<br>6" Single  | <b>QS100TRDBK</b><br>1" Traverse Double  | <b>QS100TRCMBK</b><br>1" Traverse Single<br>Ceiling Mount   |
| METAL<br>2½" (5.4 cm) DIA<br>BACK PLATE,<br>1" (2.5 cm) DIA STEM x<br>4½" (10.5 cm) D;<br><hr/> 3½" (8.9 cm) RET,<br>3" (7.6 cm) PROJ | METAL<br>2½" (5.4 cm) DIA<br>BACK PLATE,<br>1" (2.5 cm) DIA STEM x<br>6¾" (17.1 cm) D;<br><hr/> 6" (15.2 cm) RET,<br>5½" (14.0 cm) PROJ | METAL<br>2½" (5.4 cm) DIA<br>BACK PLATE,<br>1" (2.5 cm) DIA STEM x<br>6¾" (17.1 cm) D;<br><hr/> 6" (15.2 cm) FRONT RET,<br>3" (7.6 cm) BACK RET;<br><hr/> 5½" (14.0 cm)<br>FRONT PROJ,<br>2½" (6.4 cm)<br>BACK PRO | METAL<br>2½" (5.4 cm) DIA<br>CEILING PLATE,<br>1" (2.5 cm) DIA STEM,<br>2¼" (5.7 cm) H x<br>3¼" (8.3 cm) D;<br><hr/> 2¾" (7.0 cm) RET,<br>Drop (distance from<br>ceiling to bottom<br>of pole):<br>2½" (6.4 cm) |
| \$27.50 ea  | \$27.50 ea  | \$27.50 ea   | \$27.50 ea  |

### Included in System: 1" Hand Drawn Traverse Components

Components will be provided in the color that best matches the Quick Ship Metal finish, unless otherwise specified. See Component Color Chart See System Quantity Chart for quantity of glides included with each system. Additional components may be ordered separately.

#### Glides

|   |   |   |   |   |  |
|---|---|---|---|---|--|
| ¾" (1.0 cm) W x<br>1½" (2.9 cm) H x<br>¼" (0.6 cm) D;<br><hr/> ⅝" (1.6 cm) DROP<br>(from bottom of track<br>to bottom of eyelet<br>interior when installed)<br><br>• White Glide may be<br>substituted. Please<br>specify on order.<br><br><i>Note: White Glide<br/>                 can be useful when<br/>                 installing sheer and<br/>                 translucent fabrics<br/>                 onto the 1" Hand<br/>                 Drawn Traverse<br/>                 System.</i> |  |  |  |  |             |
|   | <b>QS100GLIDE-BZ</b><br>Standard Wheeled<br>Glide - Bronze                          | <b>QS100GLIDE-CH</b><br>Standard<br>Wheeled Glide -<br>Champagne                    | <b>QS100GLIDE-GO</b><br>Standard Wheeled<br>Glide - Gold                            | <b>QS100GLIDE-WH</b><br>Standard Wheeled<br>Glide - White                             | <b>QSAC48WAND</b><br>48" Clear Acrylic<br>Wand<br><br>½" (1.3 cm) DIA x<br>48" (121.9 cm) LENGTH |
|   | \$.55 ea  | \$.55 ea  | \$.55 ea  | \$.55 ea  | \$49.50 ea   |

#### Wand

**Glide Stops** anchor the drapery panel at the end of the track.

|   |   |   |   |   |  |
|---|---|---|---|---|--|
| ¾" (1.0 cm) W x<br>½" (1.3 cm) H x<br>¾" (0.5 cm) D;<br><hr/> ¼" (0.6 cm) DROP<br>(from bottom of track<br>to bottom of eyelet<br>interior when installed)<br><br>• White Glide Stop<br>may be substituted.<br>Please specify on<br>order.<br><br><i>Note: White Glide<br/>                 Stop can be useful<br/>                 when installing sheer<br/>                 and translucent<br/>                 fabrics onto the<br/>                 1" Hand Drawn<br/>                 Traverse System.</i> |  |  |  |  |   |
|   | <b>QS100GSTOP-BZ</b><br>Glide Stop - Bronze   | <b>QS100GSTOP-CH</b><br>Glide Stop -<br>Champagne                                   | <b>QS100GSTOP-GO</b><br>Glide Stop - Gold   | <b>QS100GSTOP-WH</b><br>Glide Stop - White  | <b>QS100TRSPL</b><br>Track Splicer<br><br>• connects the ends<br>of two tracks<br>• installs into top<br>channel<br>• included with all<br>systems over 8' |
|   | \$.55 ea  | \$.55 ea  | \$.55 ea  | \$.55 ea  | \$4.40 ea  |

#### Splicer

# Quick Ship Metal 1"

Available in all 5 Quick Ship Metal finishes.

## Quick Ship 1" Hand Drawn Traverse System

### COMPONENT COLOR CHART

|   | BRUSHED NICKEL<br>QSBN | MIDNIGHT<br>QSMID | ROSE GOLD<br>QSRG | ANTIQUE BRASS<br>QSAB | OIL RUBBED BRONZE<br>QSORB |
|---|------------------------|-------------------|-------------------|-----------------------|----------------------------|
| <b>Component* Color</b>                                   | Champagne              | Bronze            | Gold              | Gold                  | Bronze                     |
| White may be substituted<br>(Must be specified on order.) | Yes                    | Yes               | Yes               | Yes                   | Yes                        |

\*Components include Standard Wheeled Glide and Glide Stop.

### SYSTEM QUANTITY CHART

| Quantity included per set will be based on total system length | Continuous Track Length |    |    |    |    |    |    | Spliced Track Length |     |     |     |     |     |     |     |  |
|--|-------------------------|----|----|----|----|----|----|----------------------|-----|-----|-----|-----|-----|-----|-----|--|
|  | 2'                      | 3' | 4' | 5' | 6' | 7' | 8' | 9'                   | 10' | 11' | 12' | 13' | 14' | 15' | 16' |  |
| Glides (4 per foot, includes Glide Stop)                       | 8                       | 12 | 16 | 20 | 24 | 28 | 32 | 36                   | 40  | 44  | 48  | 52  | 56  | 60  | 64  |  |
| Brackets (1 per every 3-4 feet)                                | 2                       | 2  | 2  | 3  | 3  | 3  | 4  | 4                    | 4   | 5   | 5   | 5   | 6   | 6   | 6   |  |

\*Sold in pairs only.

# Quick Ship Wood and Resin 1<sup>3</sup>/<sub>8</sub>"

Available in all 5 Quick Ship Wood and Resin finishes.

## Quick Ship 1<sup>3</sup>/<sub>8</sub>" Resin Finials fit 1<sup>3</sup>/<sub>8</sub>" smooth or fluted wood poles.

|  |  |  |   |  |   |
|--|--|--|---|--|---|
|  <p> <b>QS138BRFI</b><br/>                     Bradford<br/>                     3<sup>1</sup>/<sub>4</sub>" (8.3 cm) W<br/>                     2<sup>1</sup>/<sub>4</sub>" (5.7 cm) DIA<br/>                     \$66.00 pair*                 </p> |  <p> <b>QS138EAFI</b><br/>                     Easton<br/>                     2<sup>3</sup>/<sub>8</sub>" (6.0 cm) W<br/>                     3<sup>1</sup>/<sub>2</sub>" (8.9 cm) DIA<br/>                     \$66.00 pair*                 </p> |  <p> <b>QS138HAFI</b><br/>                     Harper<br/>                     3" (7.6 cm) W<br/>                     2<sup>3</sup>/<sub>4</sub>" (7.0 cm) DIA<br/>                     \$66.00 pair*                 </p>  |  <p> <b>QS138JUFI</b><br/>                     June<br/>                     2<sup>3</sup>/<sub>4</sub>" (7.0 cm) W<br/>                     2<sup>3</sup>/<sub>4</sub>" (7.0 cm) DIA<br/>                     \$66.00 pair*                 </p> |  <p> <b>QS138LAFI</b><br/>                     Lane<br/>                     3<sup>1</sup>/<sub>2</sub>" (8.9 cm) W<br/>                     3<sup>5</sup>/<sub>8</sub>" (9.2 cm) DIA<br/>                     \$66.00 pair*                 </p> |  <p> <b>QS138LIFI</b><br/>                     Lillian<br/>                     4" (10.2 cm) W<br/>                     3<sup>3</sup>/<sub>8</sub>" (8.6 cm) DIA<br/>                     \$66.00 pair*                 </p> |
|  <p> <b>QS138LIFIGL</b><br/>                     Lillian - Mercury Glass<br/>                     4" (10.2 cm) W<br/>                     3<sup>1</sup>/<sub>2</sub>" (8.9 cm) DIA<br/>                     \$104.50 pair*                 </p>       |  <p> <b>QS138LOEC</b><br/>                     Lowell End Cap<br/>                     1" (2.5 cm) W<br/>                     1<sup>3</sup>/<sub>4</sub>" (4.4 cm) DIA<br/>                     \$27.50 pair*                 </p>                  |  <p> <b>QS138ROFI</b><br/>                     Rose - Crystal<br/>                     RESIN AND CRYSTAL<br/>                     2<sup>3</sup>/<sub>4</sub>" (7.0 cm) W<br/>                     2<sup>3</sup>/<sub>4</sub>" (7.0 cm) DIA<br/>                     \$165.00 pair*                 </p> |   |  |   |

\*Sold in pairs only.

## Quick Ship 1<sup>3</sup>/<sub>8</sub>" Holdbacks

### Metal Holdbacks Include Metal Holdback Stems.

Note: STEMS ARE INCLUDED, AND A PROJECTION OF 2", 4", OR 6" MUST BE SELECTED. Projection indicates distance from wall to back of medallion.

|  |         |               |  |                |                                |
|--|---------|---------------|--|----------------|--------------------------------|
| <br>Blake - Mercury Glass | QSBKHB2 | 2" Projection | METAL AND GLASS<br>3" (7.6 cm) DIA x<br>2 <sup>3</sup> / <sub>8</sub> " (6.0 cm) THICK | \$132.00 pair* | <i>Must select projection.</i> |
|  | QSBKHB4 | 4" Projection |  |                |                                |
|  | QSBKHB6 | 6" Projection |  |                |                                |

### Metal Holdback Stems





Base: 2" DIA  
 Stem: 1/2" DIA  
 Rose Gold

2", 4", or 6" projection must be selected.



### Resin Holdbacks Include Resin Holdback Stems.

Note: STEMS ARE INCLUDED, AND A PROJECTION OF 2", 4", OR 6" MUST BE SELECTED. Projection indicates distance from wall to back of medallion.

|  |         |               |  |                |                                |
|--|---------|---------------|--|----------------|--------------------------------|
| <br>Brooks   | QSBRHB2 | 2" Projection | RESIN<br>4" (10.2 cm) W x<br>1 1/4" (3.2 cm) THICK     | \$99.00 pair*  | <i>Must select projection.</i> |
|  | QSBRHB4 | 4" Projection |  |                |                                |
|  | QSBRHB6 | 6" Projection |  |                |                                |
| <br>Clark   | QSCKHB2 | 2" Projection | RESIN<br>3" (7.6 cm) DIA x<br>1" (2.5 cm) THICK        | \$88.00 pair*  | <i>Must select projection.</i> |
|  | QSCKHB4 | 4" Projection |  |                |                                |
|  | QSCKHB6 | 6" Projection |  |                |                                |
| <br>Miranda | QSMIHB2 | 2" Projection | RESIN<br>5" (12.7 cm) DIA x<br>1 1/2" (3.8 cm) THICK   | \$115.50 pair* | <i>Must select projection.</i> |
|  | QSMIHB4 | 4" Projection |  |                |                                |
|  | QSMIHB6 | 6" Projection |  |                |                                |
| <br>Trudy   | QSTRHB2 | 2" Projection | RESIN<br>4 3/4" (12.1 cm) DIA x<br>3/4" (1.9 cm) THICK | \$93.50 pair*  | <i>Must select projection.</i> |
|  | QSTRHB4 | 4" Projection |  |                |                                |
|  | QSTRHB6 | 6" Projection |  |                |                                |

### Resin Holdback Stems

Base: 3 1/8" DIA  
 Stem: 3/4" DIA  
 Platinum

2", 4", or 6" projection must be selected.

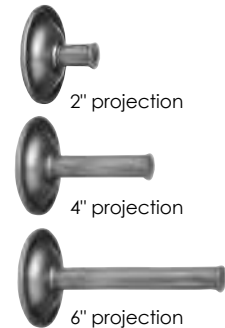





\*Sold in pairs only.



# Quick Ship Wood and Resin 1 3/8"

Available in all 5 Quick Ship Wood and Resin finishes.

## Quick Ship 1 3/8" Brackets

Note: Bracket return indicates distance from wall to center of pole. Bracket projection indicates distance from wall to back of pole.

|  |  |  |  |  |
|--|--|--|--|--|
|  <p><b>QS138MCMBK</b><br/>1 3/8" Metal Ceiling Mount</p> <p>2" (5.1 cm) W x<br/>2 3/4" (7.0 cm) H x<br/>2" (5.1 cm) D;</p> <hr/> <p>Base: 2" (5.1 cm) DIA<br/>Cradle: 1" (2.5 cm) W x<br/>1 7/8" (4.8 cm) OD x<br/>1 1/2" (3.8 cm) ID</p> <p>Drop (distance from ceiling to bottom of pole): 2 5/8" (6.7 cm)</p> <p><b>\$33.00 ea</b></p> |  <p><b>QS138MIBK</b><br/>1 3/8" Metal Inside Mount</p> <p>1" (2.5 cm) W x<br/>1 1/4" (3.2 cm) H x<br/>2 1/8" (5.4 cm) D</p> <p><b>\$66.00 pair*</b></p> | <p><b>Note:</b> Pair includes right and left (set screw located in back when installed)</p>  <p><b>QS138WISBK</b><br/>William 3" Single</p> <p>RESIN<br/>1" (2.5 cm) W x<br/>3 1/2" (8.9 cm) H x<br/>5" (12.7 cm) D;<br/>3 3/4" (9.5 cm) RET,<br/>3" (7.6 cm) PROJ</p> <p><b>\$27.50 ea</b></p> |  <p><b>QS138WIS6BK</b><br/>William 6" Single</p> <p>RESIN<br/>1" (2.5 cm) W x<br/>3 1/2" (8.9 cm) H x<br/>7 7/8" (20.0 cm) D;<br/>6 3/4" (17.1 cm) RET,<br/>6" (15.2 cm) PROJ</p> <p><b>\$38.50 ea</b></p> |  <p><b>QS138WIDBK</b><br/>William 6" Double - Resin</p> <p>RESIN<br/>1" (2.5 cm) W x<br/>3 3/8" (8.6 cm) H x<br/>7 7/8" (20.0 cm) D;</p> <hr/> <p>6 3/4" (17.1 cm) FRONT RET,<br/>3 1/4" (8.3 cm) BACK RET;<br/>6" (15.2 cm) FRONT PROJ,<br/>2 1/2" (6.4 cm) BACK PROJ</p> <p>Both Cradles hold 1 3/8" pole</p> <p><b>\$38.50 ea</b></p> |
|--|--|--|--|--|

|   |  |   |
|---|--|---|
|  <p><b>QS138WSSBK</b><br/>Winston 3" Single</p> <p>METAL<br/>3/4" (1.9 cm) W x<br/>3 3/4" (9.5 cm) H x<br/>4 3/8" (11.1 cm) D;<br/>3 1/2" (8.9 cm) RET,<br/>2 7/8" (7.3 cm) PROJ</p> <p><b>\$33.00 ea</b></p> |  <p><b>QS138WSS6BK</b><br/>Winston 6" Single</p> <p>METAL<br/>3/4" (1.9 cm) W x<br/>3 3/4" (9.5 cm) H x<br/>6 3/4" (17.1 cm) D;<br/>6" (15.2 cm) RET,<br/>5 3/8" (13.7 cm) PROJ</p> <p><b>\$38.50 ea</b></p> |  <p><b>QS138WSDBK</b><br/>Winston 6" Double</p> <p>METAL<br/>3/4" (1.9 cm) W x<br/>3 3/4" (9.5 cm) H x<br/>7" (17.8 cm) D;<br/>6" (15.2 cm) FRONT RET,<br/>3" (7.6 cm) BACK RET;<br/>5 3/8" (13.7 cm) FRONT PROJ,<br/>2 3/8" (6.0 cm) BACK PROJ</p> <p>Both Cradles hold 1 3/8" pole</p> <p><b>\$38.50 ea</b></p> |
|---|--|---|

## Quick Ship 1 3/8" Rings

Note: Ring drop indicates distance from bottom of pole to bottom of ring.

|   |  |
|---|--|
|  <p><b>QS138MRI</b><br/>1 3/8" Metal Ring</p> <p>METAL<br/>3/16" (0.5 cm) W<br/>1 3/4" (4.4 cm) ID<br/>2 1/4" (5.7 cm) OD<br/>1/2" (1.3 cm) DROP</p> <p><b>\$5.50 ea</b></p> |  <p><b>QS138WRI</b><br/>1 3/8" Wood Ring</p> <p>WOOD<br/>1/2" (1.3 cm) W<br/>1 3/4" (4.4 cm) ID<br/>2 5/8" (6.7 cm) OD<br/>3/4" (1.9 cm) DROP</p> <p><b>\$6.60 ea</b></p> |
|---|--|

\*Sold in pairs only.

## Quick Ship 1<sup>3</sup>/<sub>8</sub>" Wood Poles

Note: All orders with poles and/or Traverse track will incur a \$10.00 packaging fee per order.

|                                      |                                      |                                      |                                       |  |  |
|--------------------------------------|--------------------------------------|--------------------------------------|---------------------------------------|--|--|
| QS138FL02<br>2' Fluted<br>\$33.00 ea | QS138FL04<br>4' Fluted<br>\$66.00 ea | QS138FL06<br>6' Fluted<br>\$99.00 ea | QS138FL08<br>8' Fluted<br>\$132.00 ea | QS138FL10<br>10' Fluted<br>\$165.00 ea | QS138FL12<br>12' Fluted<br>\$198.00 ea |
|--------------------------------------|--------------------------------------|--------------------------------------|---------------------------------------|--|--|

|                                      |                                      |                                      |                                       |  |  |
|--------------------------------------|--------------------------------------|--------------------------------------|---------------------------------------|--|--|
| QS138SM02<br>2' Smooth<br>\$33.00 ea | QS138SM04<br>4' Smooth<br>\$66.00 ea | QS138SM06<br>6' Smooth<br>\$99.00 ea | QS138SM08<br>8' Smooth<br>\$132.00 ea | QS138SM10<br>10' Smooth<br>\$165.00 ea | QS138SM12<br>12' Smooth<br>\$198.00 ea |
|--------------------------------------|--------------------------------------|--------------------------------------|---------------------------------------|--|--|

## Quick Ship 1<sup>3</sup>/<sub>8</sub>" Accessories

Note: Hinged Resin Elbow available in all Quick Ship Wood and Resin finishes.

|  |  |   |
|--|--|---|
|  <p>QS138REL<br/>1<sup>3</sup>/<sub>8</sub>" Hinged Resin Elbow<br/>1<sup>5</sup>/<sub>8</sub>" (4.1 cm) DIA x 3<sup>7</sup>/<sub>8</sub>" (9.8 cm) TOTAL LENGTH, 1<sup>15</sup>/<sub>16</sub>" (4.9 cm) each side when bent<br/>\$38.50 ea</p> |  <p>QSAC36WAND<br/>36" Clear Acrylic Wand<br/>ACRYLIC, CLEAR ONLY<br/>1/2" (1.3 cm) DIA x 36" (91.4 cm) LENGTH<br/>\$44.00 ea</p> |  <p>QSAC48WAND<br/>48" Clear Acrylic Wand<br/>ACRYLIC, CLEAR ONLY<br/>1/2" (1.3 cm) DIA x 48" (121.9 cm) LENGTH<br/>\$49.50 ea</p> |
|--|--|---|

\*Sold in pairs only.



# Quick Ship Wood and Resin 2 1/4"

Available in all 5 Quick Ship Wood and Resin finishes.

## Quick Ship 2 1/4" Resin Finials fit 2 1/4" smooth or fluted wood poles.

|  |   |  |  |  |
|--|---|--|--|--|
|  <p>QS214ADFI<br/>Adelaide<br/>5" (12.7 cm) W<br/>3 1/2" (8.9 cm) DIA<br/>\$82.50 pair*</p> |  <p>QS214ADFIGL<br/>Adelaide - Mercury Glass<br/>5" (12.7 cm) W<br/>3 3/8" (8.6 cm) DIA<br/>\$121.00 pair*</p> |  <p>QS214BEFI<br/>Beatrice<br/>4 1/4" (10.8 cm) W<br/>4" (10.2 cm) DIA<br/>\$104.50 pair*</p> |  <p>QS214BREC<br/>Brinley End Cap<br/>1 1/2" (3.8 cm) W<br/>2 3/4" (7.0 cm) DIA<br/>\$33.00 pair*</p> |  <p>QS214EDFI<br/>Edward<br/>4 1/4" (10.8 cm) W<br/>3 1/4" (8.3 cm) DIA<br/>\$82.50 pair*</p> |
|--|---|--|--|--|

|   |   |   |  |
|---|---|---|--|
|  <p>QS214FIFI<br/>Fiona<br/>4" (10.2 cm) W<br/>5 1/4" (13.3 cm) DIA<br/>\$104.50 pair*</p> |  <p>QS214HZFI<br/>Hazel - Crystal<br/>RESIN AND CRYSTAL<br/>2 3/4" (7.0 cm) W<br/>3 1/4" (8.3 cm) DIA<br/>\$198.00 pair*</p> |  <p>QS214OLFI<br/>Oliver<br/>3 3/4" (9.5 cm) W<br/>3 3/4" (9.5 cm) DIA<br/>\$82.50 pair*</p> |  <p>QS214STFI<br/>Stella<br/>2 1/4" (5.7 cm) W<br/>3 1/4" (8.3 cm) DIA<br/>\$82.50 pair*</p> |
|---|---|---|--|

\*Sold in pairs only.

## Quick Ship 2¼" Holdbacks

### Metal Holdbacks Include Metal Holdback Stems.

Note: Metal Holdbacks only fit Metal Holdback Stems. STEMS ARE INCLUDED, AND A PROJECTION OF 2", 4", OR 6" MUST BE SELECTED. Projection indicates distance from wall to back of medallion.

|  |         |               |  |                |                                |
|--|---------|---------------|--|----------------|--------------------------------|
| <br>Blake - Mercury Glass | QSBKHB2 | 2" Projection | METAL AND GLASS<br>3" (7.6 cm) DIA x<br>2⅝" (6.0 cm) THICK | \$132.00 pair* | <b>Must select projection.</b> |
|  | QSBKHB4 | 4" Projection |  |                |                                |
|  | QSBKHB6 | 6" Projection |  |                |                                |

### Metal Holdback Stems

Base: 2" DIA  
Stem: ½" DIA  
Rose Gold

2", 4", or 6" projection must be selected.



2" projection



4" projection



6" projection

### Resin Holdbacks Include Resin Holdback Stems.

Note: Resin Holdbacks only fit Resin Holdback Stems. STEMS ARE INCLUDED, AND A PROJECTION OF 2", 4", OR 6" MUST BE SELECTED. Projection indicates distance from wall to back of medallion.

|  |         |               |   |                |                                |
|--|---------|---------------|---|----------------|--------------------------------|
| <br>Brooks   | QSBHRB2 | 2" Projection | RESIN<br>4" (10.2 cm) W x<br>1¼" (3.2 cm) THICK   | \$99.00 pair*  | <b>Must select projection.</b> |
|  | QSBHRB4 | 4" Projection |   |                |                                |
|  | QSBHRB6 | 6" Projection |   |                |                                |
| <br>Clark   | QSCKHB2 | 2" Projection | RESIN<br>3" (7.6 cm) DIA x<br>1" (2.5 cm) THICK   | \$88.00 pair*  | <b>Must select projection.</b> |
|  | QSCKHB4 | 4" Projection |   |                |                                |
|  | QSCKHB6 | 6" Projection |   |                |                                |
| <br>Miranda | QSMIHB2 | 2" Projection | RESIN<br>5" (12.7 cm) DIA x<br>1½" (3.8 cm) THICK | \$115.50 pair* | <b>Must select projection.</b> |
|  | QSMIHB4 | 4" Projection |   |                |                                |
|  | QSMIHB6 | 6" Projection |   |                |                                |
| <br>Trudy   | QSTRHB2 | 2" Projection | RESIN<br>4¾" (12.1 cm) DIA x<br>¾" (1.9 cm) THICK | \$93.50 pair*  | <b>Must select projection.</b> |
|  | QSTRHB4 | 4" Projection |   |                |                                |
|  | QSTRHB6 | 6" Projection |   |                |                                |

### Resin Holdback Stems

Base: 3/8" DIA  
Stem: 3/4" DIA  
Platinum

2", 4", or 6" projection must be selected.



2" projection



4" projection







6" projection

\*Sold in pairs only.

Quick Ship 2 1/4" Brackets

Note: Return indicates distance from wall to center of pole. Projection indicates distance from wall to back of pole.

|   |   |  |   |  |
|---|---|--|---|--|
|  <p>QS214MCMBK<br/>2 1/4" Metal Ceiling Mount<br/>1" (2.5 cm) W x 3 3/4" (9.5 cm) H x 3 1/4" (8.3 cm) D;<br/>Base: 1" (2.5 cm) W x 3 1/4" (8.3 cm) D;<br/>Cradle: 1" (2.5 cm) W x 2 7/8" (6.3 cm) ID x 2 3/4" (7.0 cm) OD<br/>Drop (distance from ceiling to bottom of pole): 3 5/8" (9.2 cm)<br/>\$38.50 ea</p> |  <p>QS214MIBK<br/>2 1/4" Metal Inside Mount<br/>1" (2.5 cm) W x 1 5/8" (4.1 cm) H x 2 7/8" (7.3 cm) D<br/>\$77.00 pair*</p> <p><i>Note: Pair includes right and left (set screw located in back when installed).</i></p> |  <p>QS214HASBK<br/>Harlan 3" Single<br/>METAL<br/>3/4" (1.9 cm) W x 3 3/4" (9.5 cm) H x 5 1/2" (14.0 cm) D;<br/>4 1/8" (10.5 cm) RET, 3" (7.6 cm) PROJ<br/>\$38.50 ea</p> |  <p>QS214HAS6BK<br/>Harlan 6" Single<br/>METAL<br/>3/4" (1.9 cm) W x 3 3/4" (9.5 cm) H x 7 1/4" (18.4 cm) D;<br/>6" (15.2 cm) RET, 5" (12.7 cm) PROJ<br/>\$44.00 ea</p> |  <p>QS214HADBK<br/>Harlan 6" Double<br/>METAL<br/>3/4" (1.9 cm) W x 3 3/4" (9.5 cm) H x 7 1/4" (18.4 cm) D;<br/>6" (15.2 cm) FRONT RET, 2 3/8" (6.0 cm) BACK RET;<br/>5" (12.7 cm) FRONT PROJ, 1 7/8" (4.8 cm) BACK PROJ<br/>\$44.00 ea</p> <p><i>Note: Front cradle holds 2 1/4" (5.7 cm). Back cradle holds 1 3/8" (3.5 cm) diameter poles.</i></p> |
|---|---|--|---|--|

|  |  |   |
|--|--|---|
|  <p>QS214WISBK<br/>William 3" Single<br/>RESIN<br/>1" (2.5 cm) W x 4" (10.2 cm) H x 6" (15.2 cm) D;<br/>4 1/8" (10.5 cm) RET, 3" (7.6 cm) PROJ<br/>\$38.50 ea</p> |  <p>QS214WIS6BK<br/>William 6" Single<br/>RESIN<br/>1" (2.5 cm) W x 4" (10.2 cm) H x 9" (22.9 cm) D;<br/>7 1/8" (18.1 cm) RET, 6" (15.2 cm) PROJ<br/>\$49.50 ea</p> |  <p>QS214WIDBK<br/>William 6" Double<br/>RESIN<br/>1" (2.5 cm) W x 3 7/8" (9.8 cm) H x 9" (22.9 cm) D;<br/>7 1/8" (18.1 cm) FRONT RET, 3 1/4" (8.3 cm) BACK RET;<br/>6" (15.2 cm) FRONT PROJ, 2 5/8" (6.7 cm) BACK PROJ<br/>\$49.50 ea</p> <p><i>Note: Front cradle holds 2 1/4" (5.7 cm). Back cradle holds 1 3/8" (3.5 cm) diameter poles.</i></p> |
|--|--|---|

Quick Ship 2 1/4" Rings

Note: Ring drop indicates distance from bottom of pole to bottom of ring.

|  |  |
|--|--|
|  <p>QS214MRI<br/>2 1/4" Metal Ring<br/>METAL<br/>1/4" (0.6 cm) W x 2 1/2" (6.4 cm) ID x 3" (7.6 cm) OD<br/>1/2" (1.3 cm) DROP<br/>\$6.60 ea</p> |  <p>QS214WRI<br/>2 1/4" Wood Ring<br/>WOOD<br/>1/2" (1.3 cm) W x 2 5/8" (6.7 cm) ID x 3 5/8" (9.2 cm) OD<br/>7/8" (2.2 cm) DROP<br/>\$7.70 ea</p> |
|--|--|

\*Sold in pairs only.

## Quick Ship 2¼" Wood Poles



Note: All orders with poles and/or traverse track will incur a \$10.00 packaging fee per order.

|                                      |                                       |                                       |                                       |  |  |
|--------------------------------------|---------------------------------------|---------------------------------------|---------------------------------------|--|--|
| QS214FL02<br>2' Fluted<br>\$57.20 ea | QS214FL04<br>4' Fluted<br>\$114.40 ea | QS214FL06<br>6' Fluted<br>\$171.60 ea | QS214FL08<br>8' Fluted<br>\$228.80 ea | QS214FL10<br>10' Fluted<br>\$286.00 ea | QS214FL12<br>12' Fluted<br>\$343.20 ea |
|--------------------------------------|---------------------------------------|---------------------------------------|---------------------------------------|--|--|

|                                      |                                       |                                       |                                       |  |  |
|--------------------------------------|---------------------------------------|---------------------------------------|---------------------------------------|--|--|
| QS214SM02<br>2' Smooth<br>\$57.20 ea | QS214SM04<br>4' Smooth<br>\$114.40 ea | QS214SM06<br>6' Smooth<br>\$171.60 ea | QS214SM08<br>8' Smooth<br>\$228.80 ea | QS214SM10<br>10' Smooth<br>\$286.00 ea | QS214SM12<br>12' Smooth<br>\$343.20 ea |
|--------------------------------------|---------------------------------------|---------------------------------------|---------------------------------------|--|--|

## Quick Ship 2¼" Accessories

Note: Hinged Resin Elbow available in all 5 Quick Ship Wood and Resin finishes.

|   |   |  |
|---|---|--|
|  <p><b>Note:</b> Elbow has smaller diameter to allow 2¼" rings to get closer to the corner.</p> <p><b>PO214REL</b><br/>2¼" Hinged Resin Elbow<br/>2¾" (6.0 cm) DIA<br/><u>5½" (13.0 cm) TOTAL LENGTH</u><br/>2¼" (6.5 cm) each side when bent<br/>\$49.50 ea</p> |  <p><b>POAC36WAND</b><br/>36" Clear Acrylic Wand<br/>ACRYLIC, CLEAR ONLY<br/>½" (1.3 cm) DIA x<br/>36" (91.4 cm) LENGTH<br/>\$44.00 ea</p> |  <p><b>POAC48WAND</b><br/>48" Clear Acrylic Wand<br/>ACRYLIC, CLEAR ONLY<br/>½" (1.3 cm) DIA x<br/>48" (121.9 cm) LENGTH<br/>\$49.50 ea</p> |
|---|---|--|

\*Sold in pairs only.



# Paris Texas Hardware Order Form

|             |                  |                 |
|-------------|------------------|-----------------|
| <b>PO #</b> | <b>Side Mark</b> | <b>Ship via</b> |
|-------------|------------------|-----------------|

| Company Information |        |     | Shipping Information |        |     |
|---------------------|--------|-----|----------------------|--------|-----|
| Company Name        | Acct # |     | Company Name         | Acct # |     |
| Contact Person      |        |     | Contact Person       |        |     |
| Street Address      |        |     | Street Address       |        |     |
| City                | State  | ZIP | City                 | State  | ZIP |
| Email               |        |     | Email                |        |     |
| Phone               |        | Fax | Phone                |        | Fax |

| Item # | Finish Code | Finish Name | Item Name | Qty | U of M | Price per Unit | Subtotal |
|--------|-------------|-------------|-----------|-----|--------|----------------|----------|
|        |             |             |           |     |        |                |          |
|        |             |             |           |     |        |                |          |
|        |             |             |           |     |        |                |          |
|        |             |             |           |     |        |                |          |
|        |             |             |           |     |        |                |          |
|        |             |             |           |     |        |                |          |
|        |             |             |           |     |        |                |          |
|        |             |             |           |     |        |                |          |
|        |             |             |           |     |        |                |          |
|        |             |             |           |     |        |                |          |
|        |             |             |           |     |        |                |          |
|        |             |             |           |     |        |                |          |
|        |             |             |           |     |        |                |          |
|        |             |             |           |     |        |                |          |
|        |             |             |           |     |        |                |          |
|        |             |             |           |     |        |                |          |
|        |             |             |           |     |        |                |          |
|        |             |             |           |     |        |                |          |
|        |             |             |           |     |        |                |          |
|        |             |             |           |     |        |                |          |
|        |             |             |           |     |        |                |          |

| Special Instructions |  |
|----------------------|--|
|                      |  |

| PTH Perfect Match™ |   |
|--------------------|---|
| Color #            | Color Name  |
|                    |   |
| Highlights         | Sheen Level   |
|                    | <input type="checkbox"/> High-Gloss <input type="checkbox"/> Eggshell |

|                         |  |
|-------------------------|--|
| Subtotal                |  |
| Perfect Match™ Upcharge |  |
| <b>Total</b>            |  |



# Heavy-Duty Ball Bearing Corded Traverse Order Form

|      |           |          |
|------|-----------|----------|
| PO # | Side Mark | Ship via |
|------|-----------|----------|

| Company Information |        | Shipping Information |        |     |     |
|---------------------|--------|----------------------|--------|-----|-----|
| Company Name        | Acct # | Company Name         | Acct # |     |     |
| Contact Person      |        | Contact Person       |        |     |     |
| Street Address      |        | Street Address       |        |     |     |
| City                | State  | City                 | State  | ZIP | ZIP |
| Email               |        | Email                |        |     |     |
| Phone               | Fax    | Phone                | Fax    |     |     |

HEAVY-DUTY BALL BEARING TRAVERSE SYSTEMS - Consult Price List for detailed specifications.

| Item # | System Length (per 2') | Custom Cut Length | Fascia Pole Diameter | Fitted                   | Smooth                   | Fascia Finish Code | Bracket Preference | Draw Preference            |                            | Cord Location              | Cord Length (standard: 120") | Carrier pinch pleat OR Ripplefold® style* | Qty | Price per Unit | Subtotal |
|--------|------------------------|-------------------|----------------------|--------------------------|--------------------------|--------------------|--------------------|----------------------------|----------------------------|----------------------------|------------------------------|---|-----|----------------|----------|
|        |                        |                   |                      |                          |                          |                    |                    | Center                     | One-way                    |                            |                              |   |     |                |          |
|        |                        |                   |                      | <input type="checkbox"/> | <input type="checkbox"/> |                    |                    | <input type="checkbox"/> L | <input type="checkbox"/> R | <input type="checkbox"/> L | <input type="checkbox"/> R   |   |     |                |          |
|        |                        |                   |                      | <input type="checkbox"/> | <input type="checkbox"/> |                    |                    | <input type="checkbox"/> L | <input type="checkbox"/> R | <input type="checkbox"/> L | <input type="checkbox"/> R   |   |     |                |          |
|        |                        |                   |                      | <input type="checkbox"/> | <input type="checkbox"/> |                    |                    | <input type="checkbox"/> L | <input type="checkbox"/> R | <input type="checkbox"/> L | <input type="checkbox"/> R   |   |     |                |          |

HEAVY-DUTY BALL BEARING TRAVERSE COORDINATING ACCESSORIES - Order finials, extra brackets, and accessories here.

| Item # | Finish Code | Description | Qty | Price per Unit | Subtotal |
|--------|-------------|-------------|-----|----------------|----------|
|        |             |             |     |                |          |
|        |             |             |     |                |          |
|        |             |             |     |                |          |

Additional Information

|  |    |    |    |    |    |     |     |     |     |     |     |     |     |     |     |     |
|--|----|----|----|----|----|-----|-----|-----|-----|-----|-----|-----|-----|-----|-----|-----|
| Quantity included per set based on cut pole length               | 4' | 6' | 7' | 8' | 9' | 10' | 11' | 12' | 13' | 14' | 15' | 16' | 17' | 18' | 19' | 20' |
| Slides [4 per foot, includes master carriers (2) & end caps (2)] | 16 | 24 | 28 | 32 | 36 | 40  | 44  | 48  | 52  | 56  | 60  | 64  | 68  | 72  | 76  | 80  |
| Brackets (1 per every 3-4 feet)                                  | 2  | 3  | 3  | 4  | 4  | 4   | 5   | 5   | 5   | 6   | 6   | 6   | 7   | 7   | 7   | 8   |

PTH Perfect Match™

|            |   |
|------------|---|
| Color #    | Color Name  |
|            |   |
| Highlights | Sheen Level   |
|            | <input type="checkbox"/> High-Gloss <input type="checkbox"/> Eggshell |

SPECIAL INSTRUCTIONS

\*When ordering Ripplefold® style carriers, answer these questions:

1. Select Ripplefold® style fullness:  80%  100%  120%

2. Select Ripplefold® style masters:  Buttmaster  Overlap



# Motorized Traverse Order Form



|      |           |          |
|------|-----------|----------|
| PO # | Side Mark | Ship via |
|------|-----------|----------|

| Company Information |                | Shipping Information |        |
|---------------------|----------------|----------------------|--------|
| Company Name        | Acct #         | Company Name         | Acct # |
| Contact Person      | Street Address | Contact Person       | State  |
| City                | State          | Street Address       | ZIP    |
| Email               | City           | City                 | State  |
| Phone               | ZIP            | Email                | ZIP    |
| Fax                 | Phone          | Phone                | Fax    |

**MOTORIZED TRAVERSE SYSTEMS - Consult Price List for detailed specifications.**

Specified custom cut length indicates track length including drive gears; fascia will be 1/4" longer at each end of track (1/2" total); mitered fascia will be 1 1/2" longer at each end of track (3" total).

| Item # | System Length (6'-40") | Custom Cut Length | Fascia Pole Diameter | Fitted                   | Smooth                   | Fascia Finish Code | Bracket Preference | Draw Preference Center   |                          | Motor Type | Motor Location           |                          | Carrier pinch pleat OR Ripplefold® style** | Qty | Price per Unit | Subtotal |
|--------|------------------------|-------------------|----------------------|--------------------------|--------------------------|--------------------|--------------------|--------------------------|--------------------------|------------|--------------------------|--------------------------|--|-----|----------------|----------|
|        |                        |                   |                      |                          |                          |                    |                    | L                        | R                        |            | L                        | R                        |  |     |                |          |
|        |                        |                   |                      | <input type="checkbox"/> | <input type="checkbox"/> |                    |                    | <input type="checkbox"/> | <input type="checkbox"/> |            | <input type="checkbox"/> | <input type="checkbox"/> |  |     |                |          |
|        |                        |                   |                      | <input type="checkbox"/> | <input type="checkbox"/> |                    |                    | <input type="checkbox"/> | <input type="checkbox"/> |            | <input type="checkbox"/> | <input type="checkbox"/> |  |     |                |          |
|        |                        |                   |                      | <input type="checkbox"/> | <input type="checkbox"/> |                    |                    | <input type="checkbox"/> | <input type="checkbox"/> |            | <input type="checkbox"/> | <input type="checkbox"/> |  |     |                |          |

**MOTORIZED TRAVERSE COORDINATING ACCESSORIES - Order finials, additional motors for tandem applications, and accessories here.**

| Item # | Finish Code | Description | Qty | Price per Unit | Subtotal |
|--------|-------------|-------------|-----|----------------|----------|
|        |             |             |     |                |          |
|        |             |             |     |                |          |
|        |             |             |     |                |          |
|        |             |             |     |                |          |

\* BTX-DC-120 Systems are available in continuous lengths up to 20' and in spliced lengths up to 40'. BTX-DC-35 Systems are available in continuous lengths up to 18'. Symplex 35 Systems are available in continuous lengths up to 20' and in spliced lengths up to 32'. Symplex 60e Systems are available in continuous lengths up to 20' and in spliced lengths up to 36'. a system more than the maximum spliced length, two one-way systems can butt against each other behind fascia. Must be specified.

\*\* Ripplefold® style carriers incur a 10% upcharge per track. Must specify carrier fullness.

| PTH Perfect Match™                  |                                   |
|-------------------------------------|-----------------------------------|
| Color #                             | Color Name                        |
| Highlights                          | Sheen Level                       |
| <input type="checkbox"/> High-Gloss | <input type="checkbox"/> Eggshell |

**SPECIAL INSTRUCTIONS**

\*\*When ordering Ripplefold® style carriers, answer these questions:

1. Select Ripplefold® style fullness:  80%  100%  120%

2. Select Ripplefold® style masters:  Buttmaster  Overlap



*PTH*

**PARIS TEXAS  
HARDWARE**

[www.paristexashardware.com](http://www.paristexashardware.com)