

STEEL #3 AIR COOLED CABINET

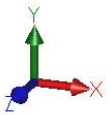

FRONT

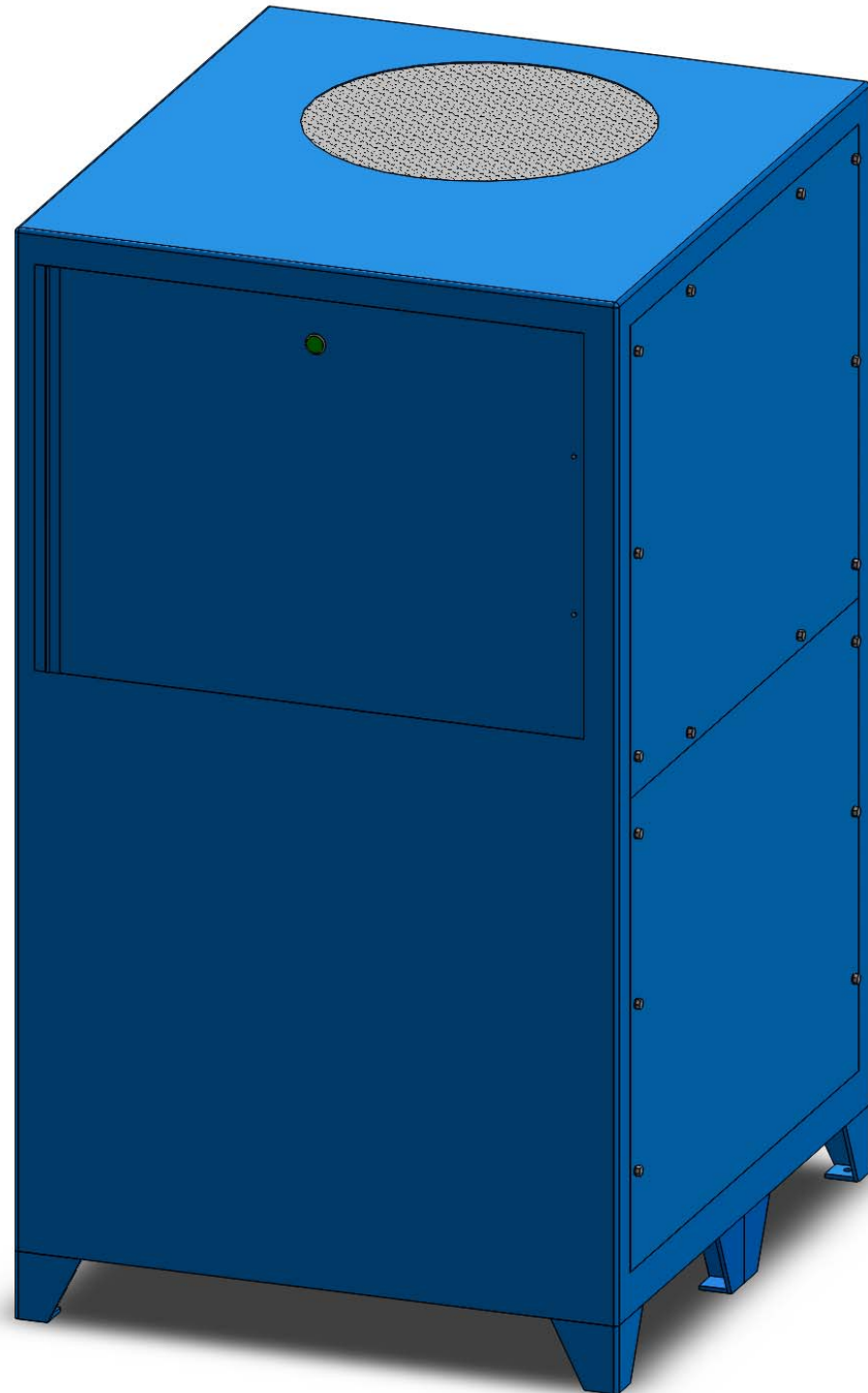
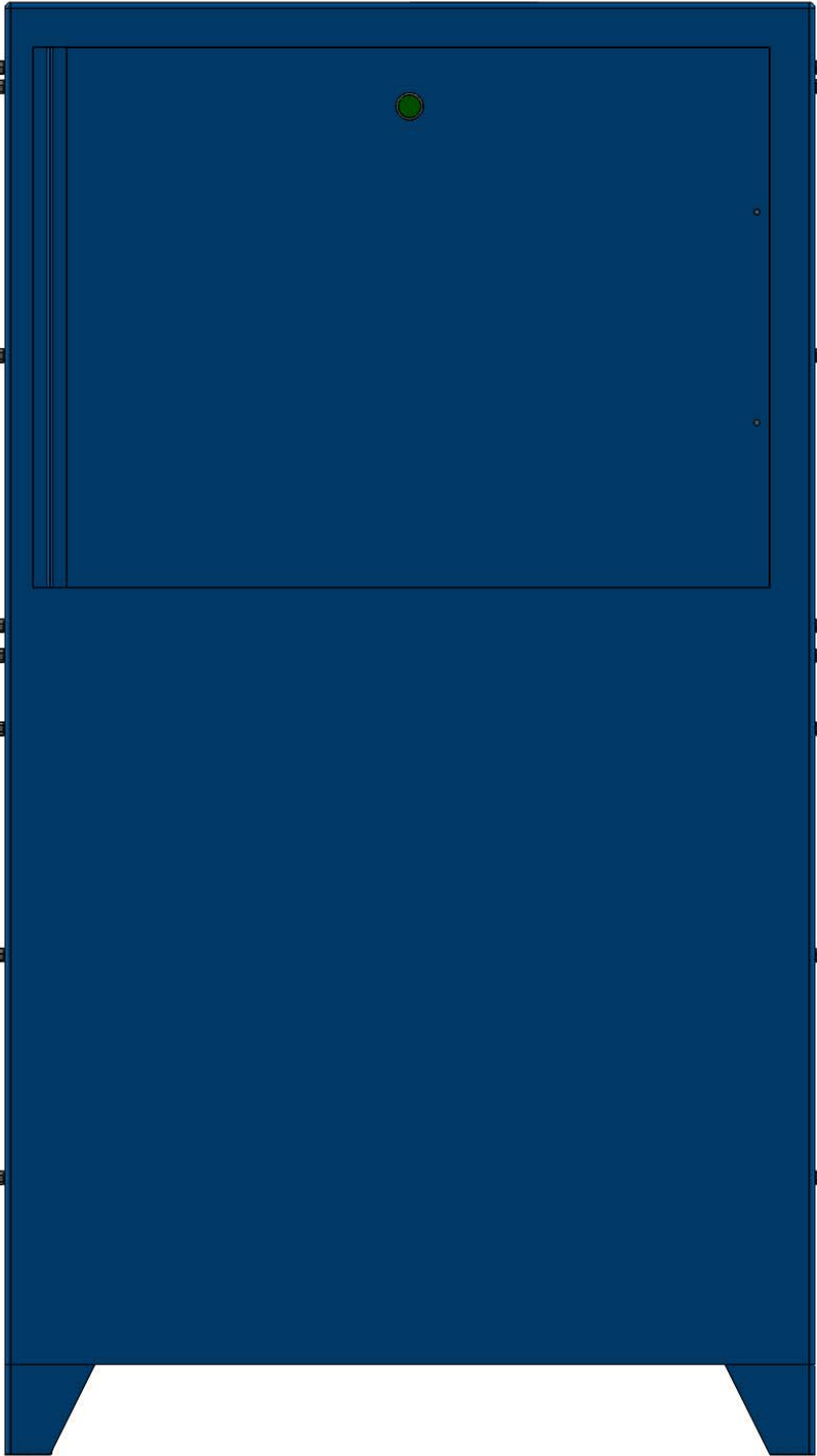

RIGHT

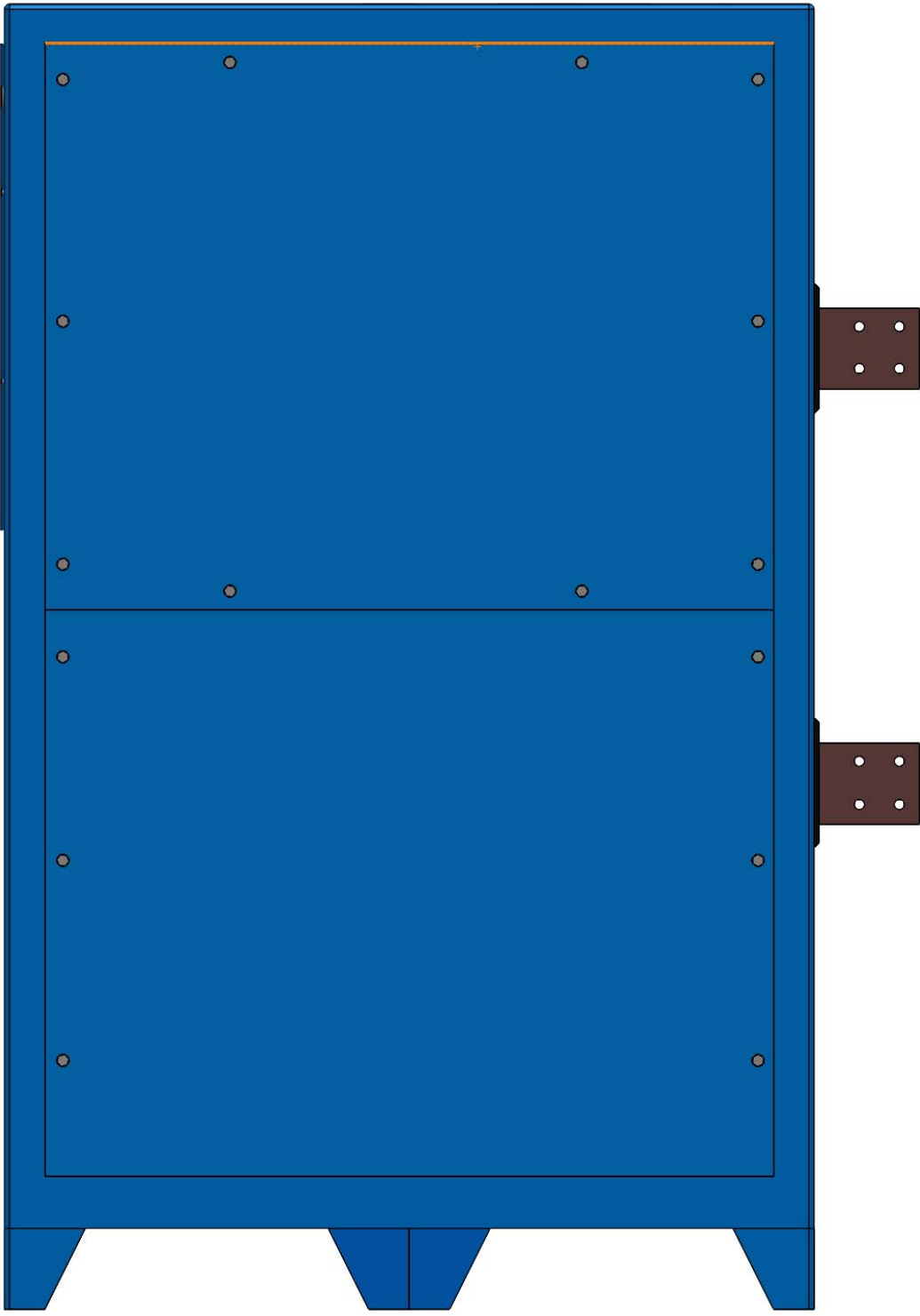

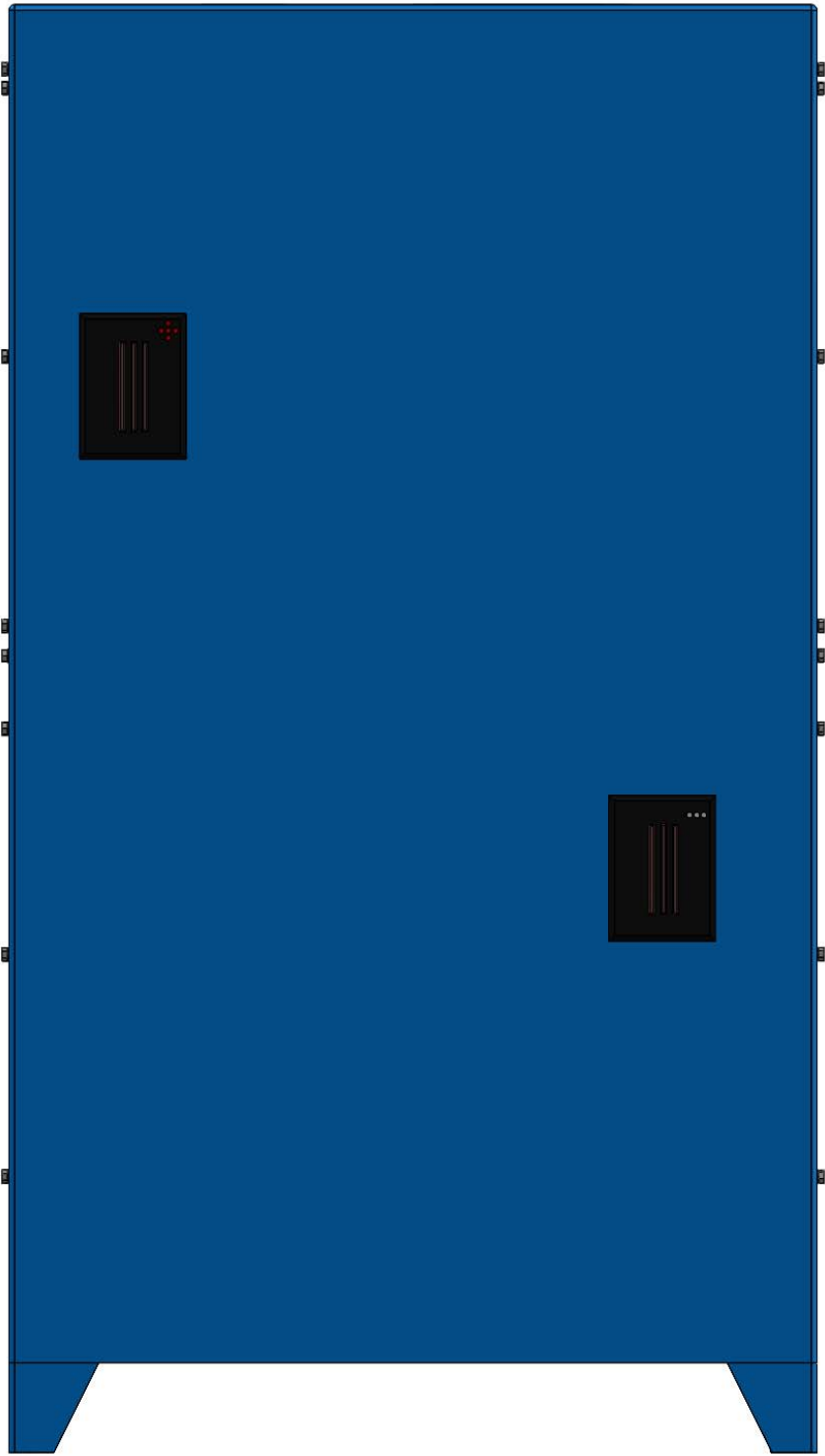

LEFT

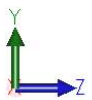
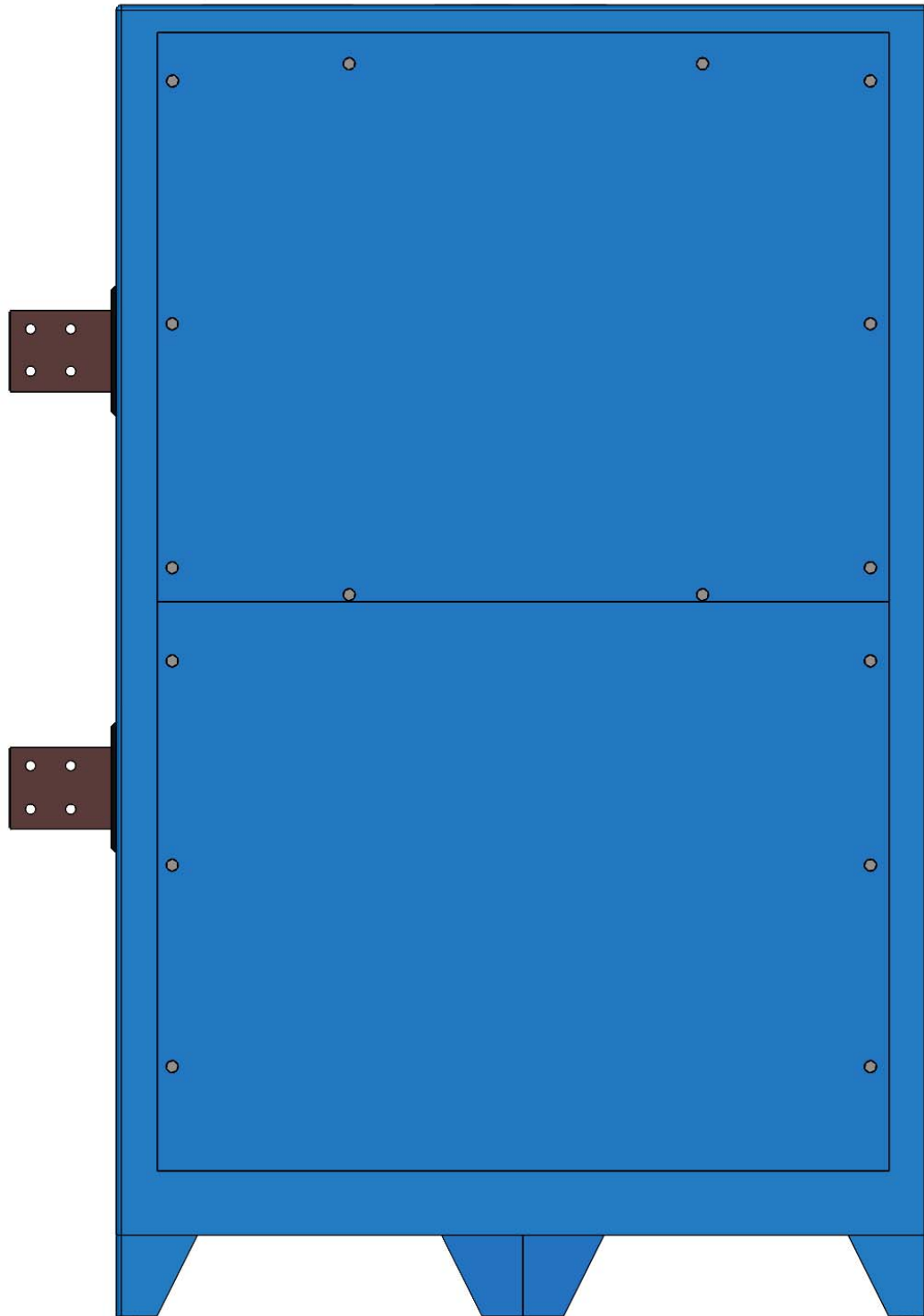

TOP

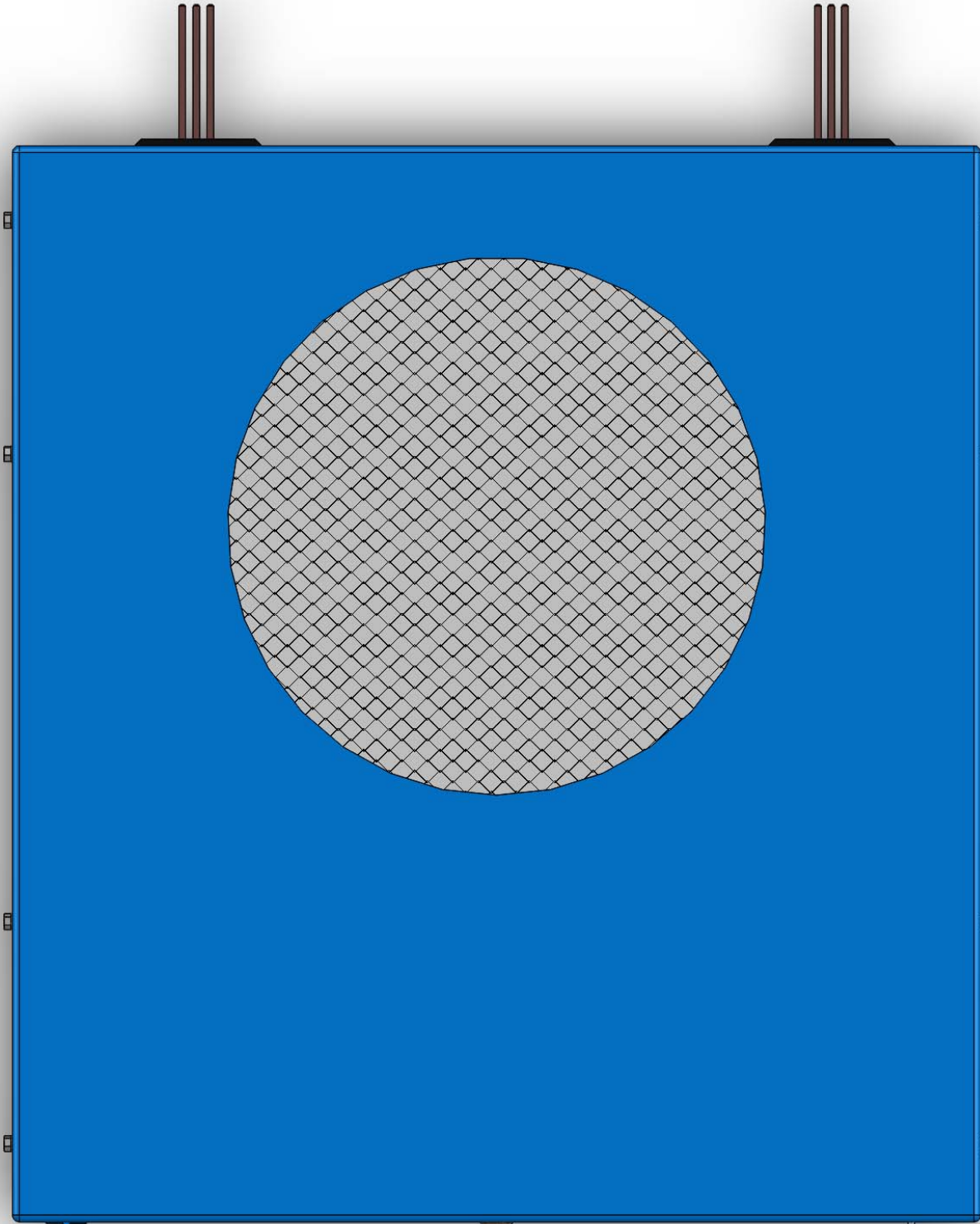

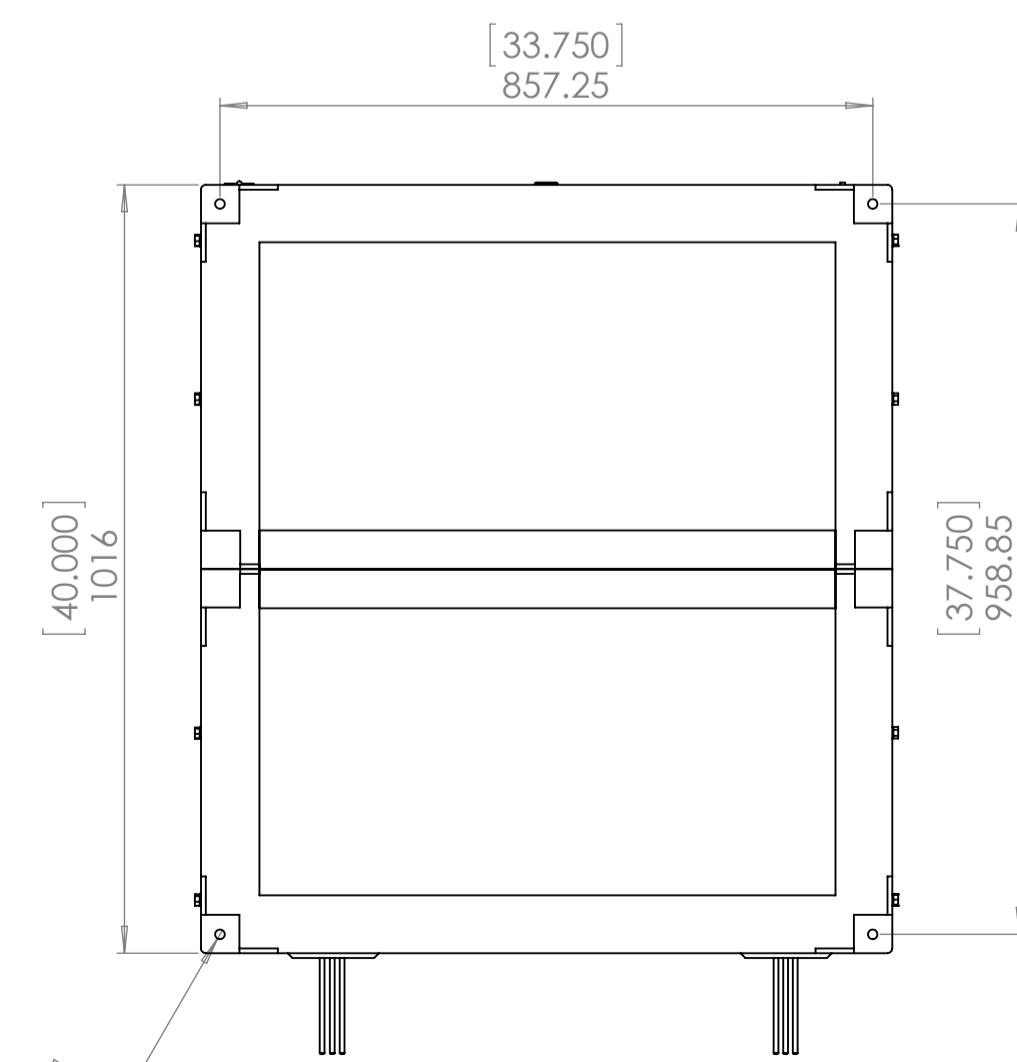
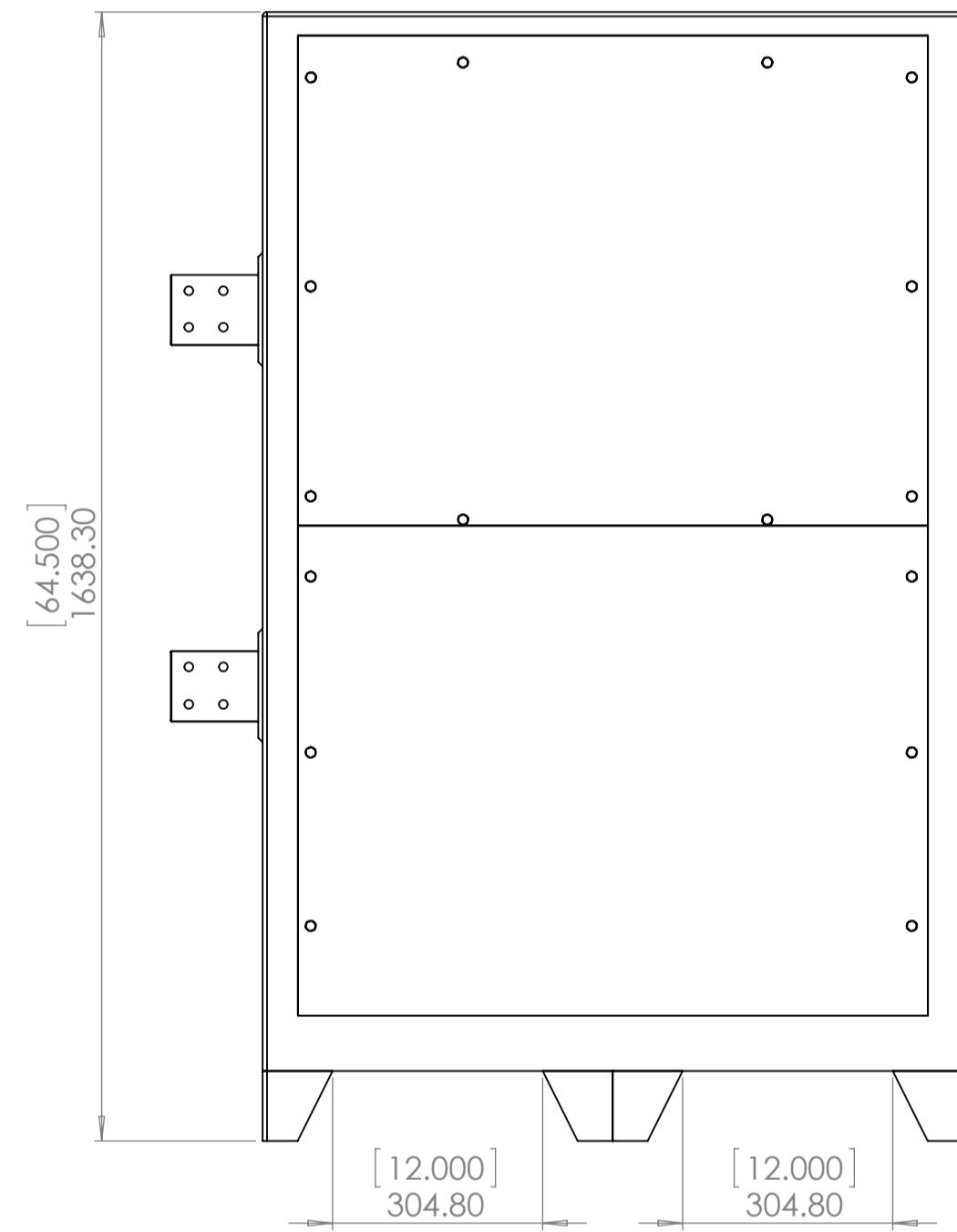
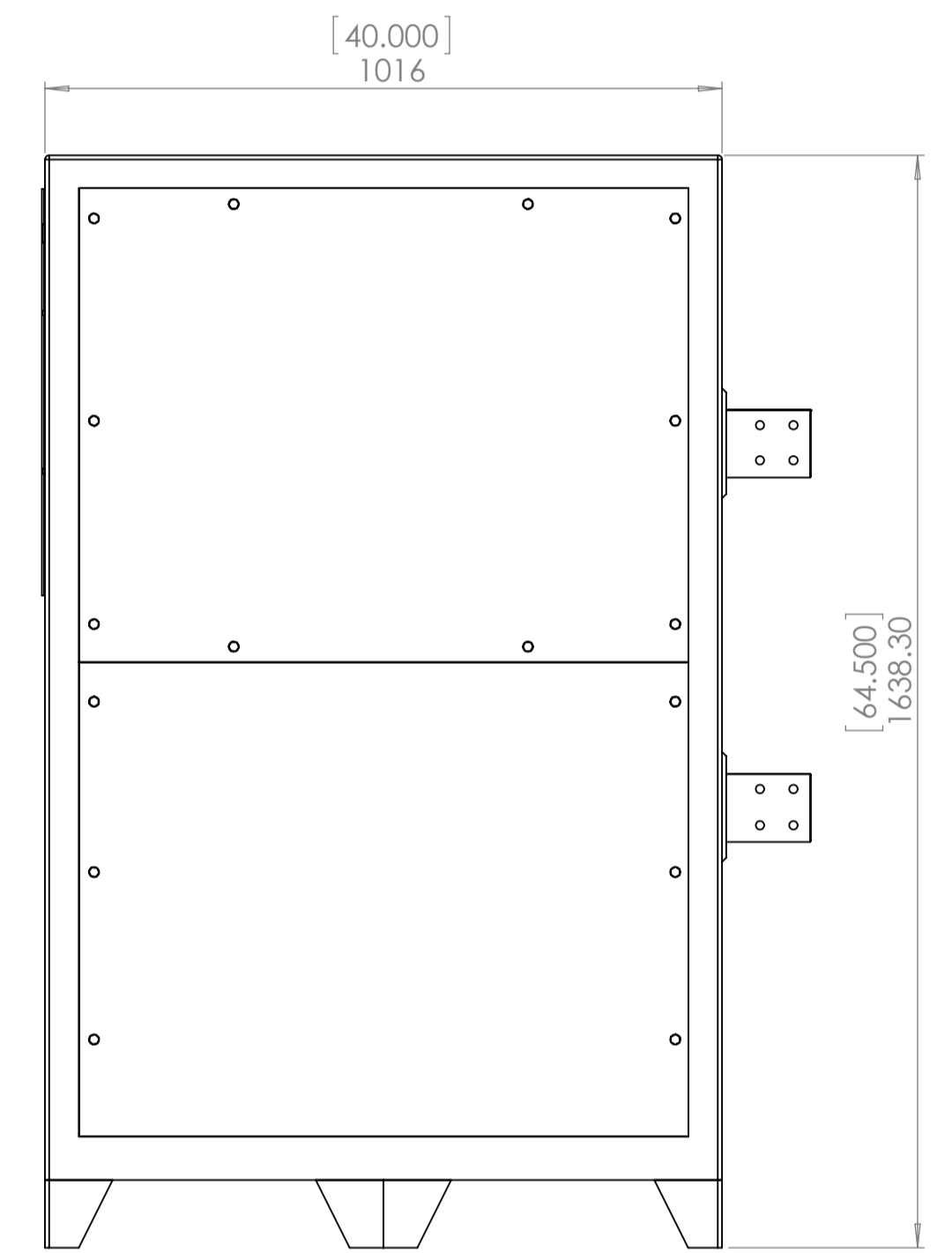
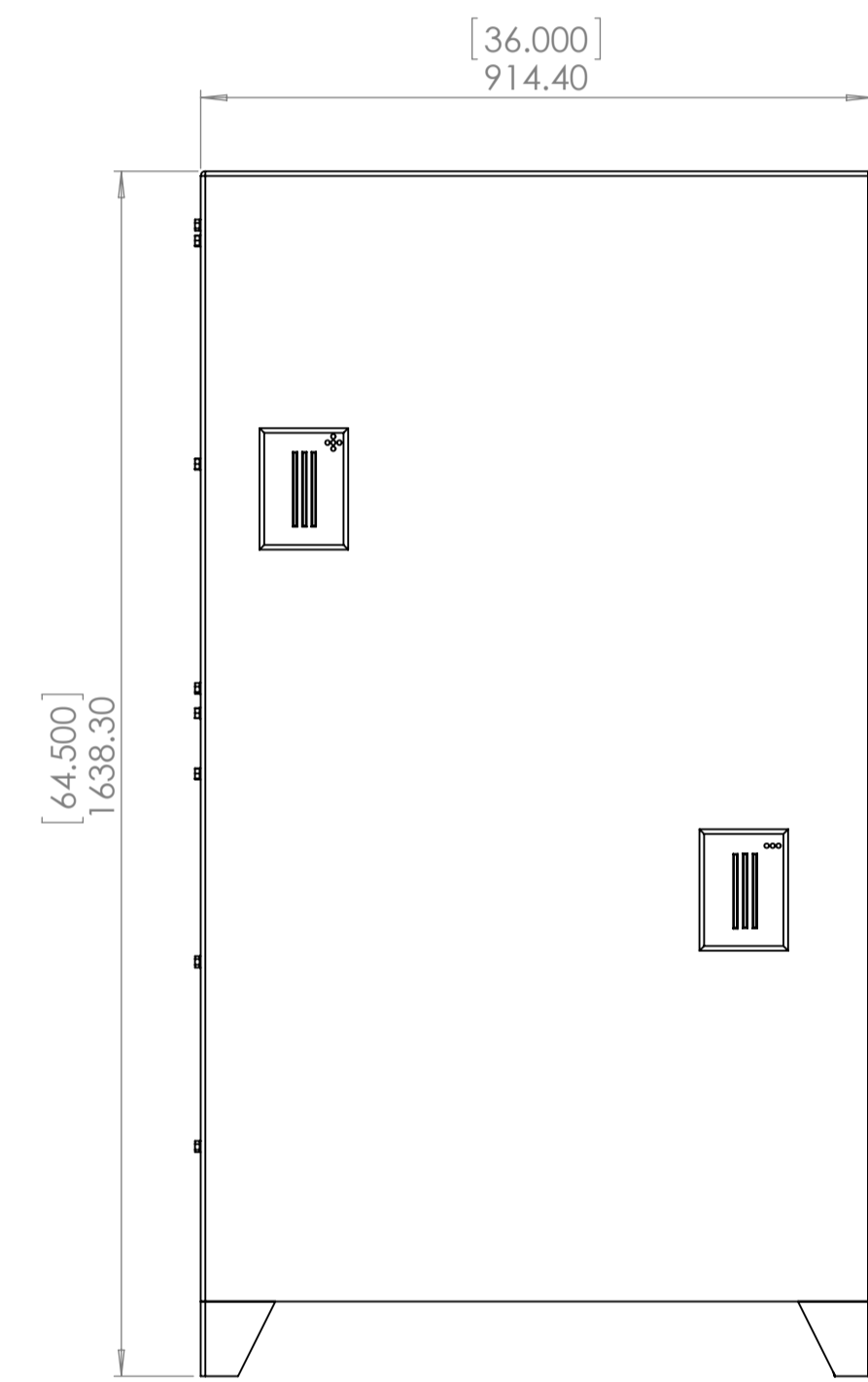
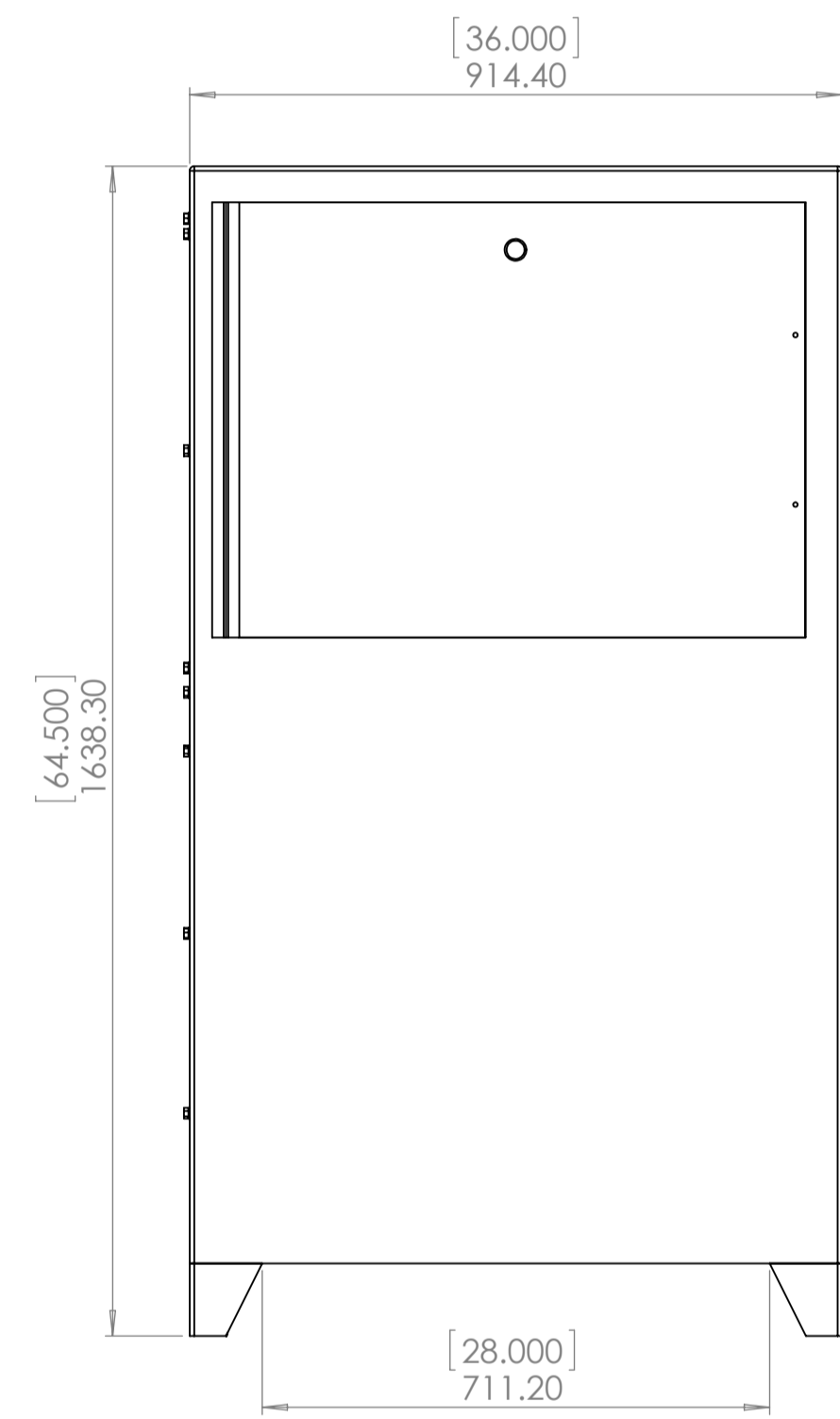
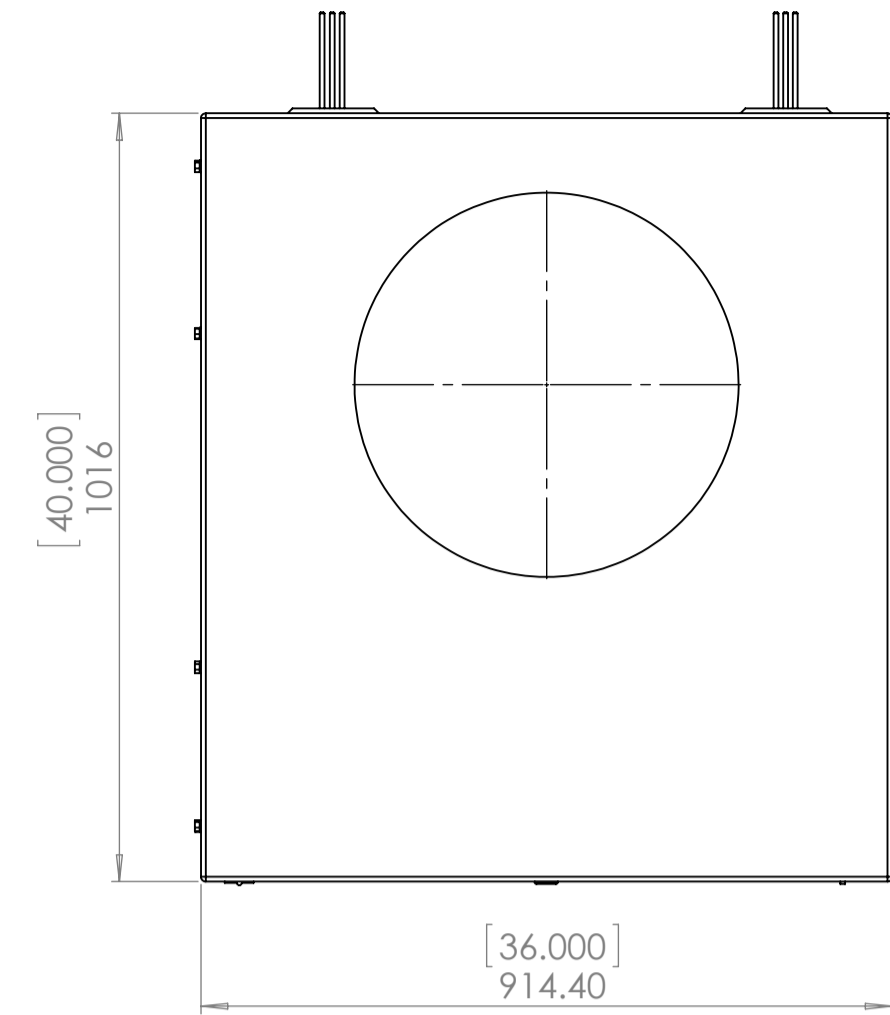

[0.375]
Ø 9.53

UNLESS OTHERWISE SPECIFIED: DIMENSIONS ARE IN MILLIMETERS SURFACE FINISH: TOLERANCES: LINEAR: ANGULAR:			FINISH:	DEBUR AND BREAK SHARP EDGES	DO NOT SCALE DRAWING	REVISION
				ALDONEX, INC.		
				TITLE: ENCLOSURE		
DRAWN	SO	SIGNATURE	DATE			
CHK'D	SO		6-12-19			
APP'VD:			6-12-19			
MPG						
Q.A.				MATERIAL: STEEL	DWG NO.	S-3A CABINET
				WEIGHT:	SCALE: 1:10	SHEET 1 OF 1