









-  Service Manual – Compact 3020
-  Service-Handbuch – Compact 3020
-  Manuel d'entretien – Compact 3020
-  Servicehandleiding – Compact 3020
-  Manual de servicio – Compact 3020
-  Manuale di servizio – Compact 3020



## TABLE OF CONTENTS

Section	Page
1. About the Alde central heating system	4
1:1 General care of the heating system	4
2. About the Compact 3020	5
2:1 Boiler function	5
2:2 Boiler	6
2:3 Technical data	7
3. Component replacement	8
3:1 Circuit board replacement	8
3:2 Fan replacement	9
3:3 Burner replacement	9
3:4 Spark plug replacement	10
3:5 Sensor replacement	10
3:6 Solenoid valve replacement	10
3:7 Sensor replacement	11
4. Error message on the control panel	12
5. Safety checks	14
6. Exploded drawing	15
7. Spare parts	16
8. Component and wiring diagram	17

### **WARNING**

**The information contained in this manual must be followed to the letter, otherwise fire or explosion may result in damage to property, personal injury or death.**

– Do not store petrol or other flammable vapours and fluids in the vicinity of the Alde Compact 3020 or any other device.

#### **– WHAT TO DO IF YOU SMELL LPG**

- Evacuate everyone in the vehicle.
- Shut off the LPG supply at the cylinder/tank.
- Do not try to start up any device.
- DO NOT TOUCH any electrical switch; do not use a telephone or radio in the immediate vicinity.
- DO NOT START the vehicle's engine.
- DO NOT OPEN the LPG supply until the leak has been dealt with.
- Do not use a naked flame when troubleshooting.

– Installation and servicing must be performed by a qualified installer or service point.

## FOREWORD

This service manual is intended to help with servicing and troubleshooting in caravans and motor caravans equipped with an Alde Compact 3020. The manual is also intended to help with the ordering of spare parts. In addition, it provides general information about the design and operation of Alde's central heating system.

## SAFETY SYMBOLS

Safety symbols warn of potential safety risks. You must comply with all the safety messages which appear after these symbols.

Safety warnings in this manual use the following symbols:

### **DANGER**

Indicates a risk which can result in injury or death.

### **WARNING**

Indicates a risk which can result in injury or material damage.

## SAFETY REGULATIONS

### **DANGER FIRE/EXPLOSION RISK**

- Do not use the LPG boiler when filling up the vehicle.
- Do not use a naked flame when troubleshooting.
- Only Alde original parts may be used as spare parts.

### **DANGER CARBON MONOXIDE POISONING**

- This boiler may produce dangerous carbon monoxide (CO) gas unless installed and used correctly. Do not use the boiler without adequate ventilation.

Possible symptoms of CO poisoning are headaches, dizziness and/or nausea. If you have these symptoms, get some fresh air and seek immediate medical attention.

### **WARNING DOMESTIC HOT WATER**

Domestic hot water at temperatures in excess of 55°C can scald, causing serious injury.

The heater can supply heated water at temperatures up to 80°C.

### **WARNING**

When servicing components for LPG and 230 volts, national regulations governing authorisation must be adhered to.

**These instructions are approved for The Alde Compact 3010 boiler fitted in recreational vehicles.**

**NB.** After servicing of the boiler the service log must **always** be completed.

*NB. We reserve the right to make changes after this service manual has been printed.*

Alde International Systems AB  
Service department

## 1. ABOUT THE ALDE CENTRAL HEATING SYSTEM

The central heating system consists of two or three heat sources. A boiler, a 230-volt electric element and a heat exchanger fitted externally for motor caravans. A Truma AC can also be connected to the Alde central heating system, thus giving a full automatic climate control system. The boiler/electric element heats a fluid mixture consisting of water (60%) and ethylene glycol (40%). Using a 12-volt circulation pump (a 230-volt circulation pump is available as an option) located in an expansion tank or on the boiler, the hot ethylene glycol/water mixture is circulated through the heating system via pipes and convectors.

The convectors located along the outer walls heat up the air, which rises upwards, heating walls and furnishings. Since hot air rises, an air barrier is formed, which keeps the chill away from the windows. The room temperature in the caravan is controlled by a 12-volt room thermostat on the control panel.

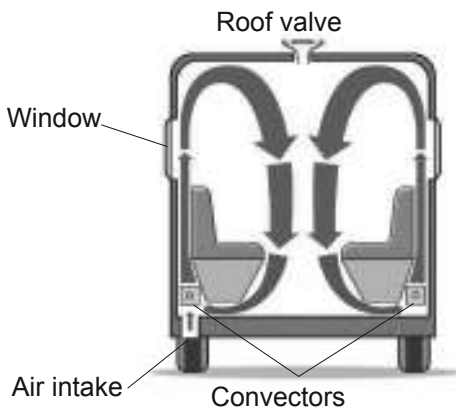
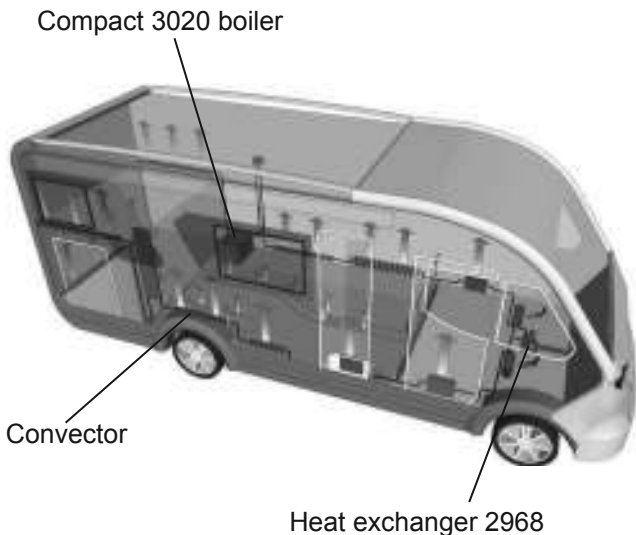

### 1:1 GENERAL CARE OF THE HEATING SYSTEM

Regularly check the heating system's fluid level in the expansion tank. With the system cold, the level should be about 1 cm above the minimum mark. The heating system should be filled with a fluid mixture made up from distilled water and ethylene glycol. For best results, use high-quality ready-mixed ethylene glycol (with inhibitor) intended for use in aluminium heating systems.

The proportions when using concentrated ethylene glycol are 60% distilled water and 40% ethylene glycol. If the heating system is likely to be exposed to temperatures below  $-25^{\circ}\text{C}$ , the ethylene glycol content must be increased, but should not exceed 50%.

Any vessels used for handling or mixing the liquid must be spotlessly clean, and the pipes in the heating system must be free of contamination. This is to prevent the growth of bacteria in the system.

The ethylene glycol mixture should be changed every two years, as it tends to deteriorate in terms of properties such as corrosion protection. The glycol content should be checked before topping up with new fluid. This is to prevent excessive concentration of ethylene glycol in the mixture.

**Filling pump** Art. no. 1900 811

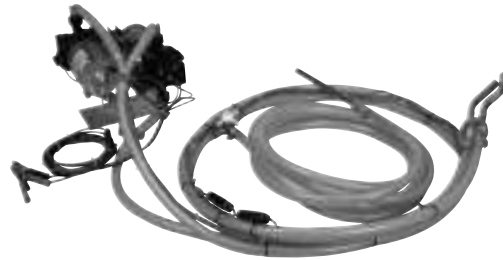

If the fluid level in the expansion tanks drops for reasons other than evaporation, check all connections, the draw-off tap and bleed screws, to ensure these are not leaking. Check also the automatic bleeder to make sure it has not jammed. If ethylene glycol has leaked out, rinse with water and dry off. **Never** allow the heating system to stand empty without ethylene glycol fluid.

#### Filling with fluid:

Make sure the vehicle is standing horizontally and check that the bleed screws and draw-off tap are closed. Undo the circulation pump's plastic nuts on the expansion tank and lift the pump up. Now slowly pour the ethylene glycol mixture into the expansion tank using a watering can. Depending on how the pipes have been fitted, air pockets may form when the system is filled with ethylene glycol fluid. If the pipes only warm up a metre or so from the boiler, even though the circulation pump is operating, this is a reliable symptom of air trapped in the system.

For ease of filling and bleeding, we recommend the Alde filling pump, which both tops up and bleeds the heating system automatically and quickly. Alde's heating system is installed with a non-return valve to prevent natural circulation. The non-return valve is normally located at the automatic bleeder on the boiler, see figure *Rubber connection with automatic bleed and non-return valve*. In

Rubber connection with automatic bleed and non-return valve.



Expansion tank with non-return valve.

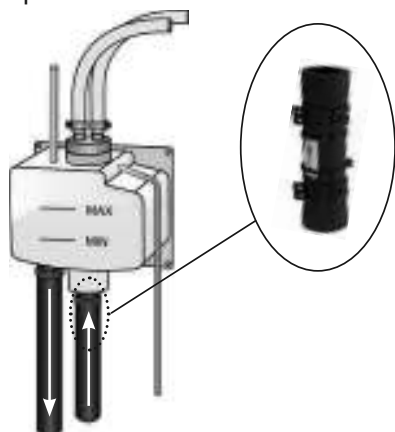

some cases the non-return valve may be located at the expansion tank, see figure *Expansion tank with non-return valve*.

**NB.** Ensure that the direction of flow in the filling pump is the same as the arrow on the non-return valve, otherwise there is a risk of the non-return valve moving or turning.

**NB.** On some vehicles the tank may be reverse mounted, which means that the flow runs in the opposite direction.

### Bleeding the heating system in a caravan (manually):

The boiler must be running and the circulation pump turned off. Start by opening the bleed screws (see the vehicle's instruction manual to find out where these are located). Keep them open until fluid comes out of the pipe at the bleed screw, and then close the screw. Start the circulation pump and let it run for a while. You can also increase the speed of the circulation pump (setting 5). See if the pipes and convectors are heating up around the caravan. Don't forget to return the circulation pump to its original setting (setting 2) once you have completed the bleeding operation.

### If the air has still not come out, you can try the following method:

The boiler must be running and the circulation pump turned off. Crank the caravan's jockey wheel down as far as needed to make it slope forwards. Leave it in this position for a few minutes to allow any air to travel upwards in the system. Open the bleed screw located at the highest point and keep it open until all the air has escaped.

Now crank the jockey wheel up to maximum position and proceed in the same manner in this position. Then position the caravan horizontally and start the circulation pump. Check that the heat is flowing around the caravan. The easiest way to bleed the system in a twin-axle caravan or motor caravan is to park the vehicle on ground which has a significant gradient or to raise one end of the vehicle using a jack.

## 2. ABOUT THE COMPACT 3020

### Layout of the boiler

The boiler consists of three eccentrically mounted pipes. The innermost pipe is the heat exchanger, which is made from extruded aluminium. Around this is the water jacket for fluid to the heating system in which it is located. It contains a 40% ethylene glycol mixture.

Outside the water jacket is the hot water heater, intended for freshwater. The two outer pipes, and their end caps and connections, are made of stainless steel.

The heat exchanger is split into two hemispheres by means of a U-shaped baffle plate.

The burner is located in the top hemisphere, which forms the combustion chamber. The baffle plate guides the flue gases on their return path into the bottom section of the profile, which forms the convection part.

The burner housing is welded in position on the end of the heat exchanger.

On the burner housing are a fan, burner, solenoid valve, and an intake as well as an exhaust gas connection. The exhaust gases are expelled through the inner pipe and the intake air is drawn in through the outer one.

The exhaust gases leave the vehicle via a hose connection through either a roof or a wall flue. The intake air is also drawn in via the same flue (balanced draft).

The upper part of the water jacket has two electric elements inserted in it. The maximum rating of the elements is 3 kW.

### 2:1 BOILER FUNCTION

The boiler is a combined unit for the production of heat and domestic hot water. The energy sources used are either electricity, LPG or a combination of the two, as well as the AC system. The two electric elements are rated at 1 kW and 2 kW, respectively. The electric power output is controlled via switches on the circuit board.

On start-up, full power output is not connected immediately, but connection is in two or three stages with a few seconds delay between each of them. The boiler has a burner which works in two stages. The lower stage is at 3 kW and the higher one at 5.5 kW. The power output stage at which the boiler works is determined by the heating need in the vehicle.

On the circuit board, all functions needed to monitor and control the boiler are connected. These can be split up into the following units:

- Monitoring and control of fan speed at the various power stages.
- Opening of the gas valve's various power stages at the correct moment.
- Ignition spark to the burner via the two spark plugs fitted to the burner.
- Monitoring of the flame by means of a sensor plug fitted to the burner.
- Control and monitoring of convector temperature via sensors fitted to the boiler body.
- Control of domestic hot water temperature via a sensor fitted to the heater.
- Control of room temperature in the vehicle via a sensor in the control panel or a sensor connected to the control panel.

## 2:2 BOILER

### Start

When the boiler receives a start signal, the system initiates a self-check period where the fan starts up at a speed of around 2700 rpm, increasing to 3300 rpm after 15 seconds. If the speed on the first check is <500 rpm, the start attempt is aborted and a new start attempt is performed. During the period the new start attempt is being performed, for some of the time the message “Fan restarts” is shown on the display. If the boiler does not start after five start attempts, “Fan failure” will be shown on the display and no more attempts are performed.

Each start attempt takes around five minutes and, beginning with the second attempt, a higher fan speed is used to get the fan running. To reset after “Fan failure” has been displayed, the main current to the boiler needs to be disconnected and reconnected. If an AC system is installed and connected to the boiler/panel, the 230 V supply must also be disconnected to remove the error message.

If the speed is within tolerance at the end of the period, a spark is generated, the solenoid valve opens the first stage for gas and the fan’s speed drops to 2200 rpm. Once the burner ignites, the electronics receive a signal via the sensor, the sparking ceases and the burner burns at stage 1 for at least one minute before switching to the second power output stage if the heating need so requires. If the burner does not ignite within 10 seconds after the gas valve is opened, the start attempt is aborted and a new cycle is commenced. If this too proves unsuccessful, no more start attempts are performed and the message “Gas failure” is displayed on the control panel. To reset the boiler, the gas symbol on the control panel must be turned off and then turned back on.

### Operation

Once the burner is in operation, the flame is monitored via the sensor plug. If the flame goes out, the signal from the sensor is interrupted and the gas supply is shut off within one second. The boiler will then perform a start attempt as described above.

The speed of the combustion fan is also monitored continually when in operation. At stage 1, the speed is 2200±50 rpm, and at stage 2, 3500±50 rpm. If the speed drops below 3150 rpm, the boiler switches down to stage 1. If the speed has also dropped below the permitted speed, the boiler is shut down completely and a new start attempt is performed. During the period the new start attempt is being performed, for some of the time the message “Fan restarts” is shown on the display. If the boiler does not start after five start attempts, “Fan failure” will be shown on the display and no more attempts are performed. Each start attempt takes around five minutes and, beginning with the second attempt, a higher fan speed is used to get the fan running. To reset after “Fan failure” has been displayed, the main current to the boiler needs to be disconnected and reconnected. If an AC system is installed and connected to the boiler/panel, the 230 V supply must also be disconnected to remove the error message.

### Switching between power output stages

The boiler always ignites at stage 1. When switching from stage 1 to 2, the fan speed increases from 2200 to 3500 rpm for around two to four seconds. When the speed exceeds 2600 rpm, the gas valve for stage 2 opens, while stage 1 is kept open for the whole time. To open the gas valve’s stages, the electronics emit 12 volts to the relevant coil’s pull circuit for one to two seconds. After this time, the valve is kept open using the hold circuit. The pull circuit has a current consumption of around 1.5 A, whereas the hold circuit’s current consumption is only around 0.05 A.

### Control

The temperature in the vehicle is controlled in terms of the difference between the actual temperature in the vehicle and the desired temperature set on the control panel ( $\Delta t$ ). If el 3 kW + gas has been selected, the boiler controls the temperature as follows:

#### $\Delta t$ Function

+0.7°C Pump 33% EI 1 kW  
+0.4°C Pump 66% EI 2 kW  
+0.0°C Pump 100% EI 3 kW  
-0.5°C Pump 100% EI 3 kW Gas stage 1 33%  
-1.0°C Pump 100% EI 3 kW Gas stage 1 66%  
-1.5°C Pump 100% EI 3 kW Gas stage 1 100%  
-2.0°C Pump 100% EI 3 kW Gas stage 1 100% stage 2 33%  
-2.5°C Pump 100% EI 3 kW Gas stage 1 100% stage 2 100%  
If e.g. only gas has been selected on the control panel, the stages for electricity do not apply and gas stage 1, 33% goes to the top of the control list. Maximum convector temperature when the circulation pump is in operation is 85–90°C. When the circulation pump shuts down the maximum temperature is 80°C.

### Domestic hot water

The boiler always retains a basic level of domestic hot water at approximately 50°C. If the temperature drops below this level, the boiler increases its power output by one level according to the control stages. This can result in the temperature rising slightly in the caravan, and this in turn results in the pump shutting down and the boiler switching to only generating domestic hot water for a certain time. If there is no heating need, but the boiler is only working to generate domestic hot water, the boiler works at the electrical power output which has been selected. If only gas has been selected the boiler works at gas stage 1. Domestic hot water control can also be deselected, e.g. at night when no domestic hot water is needed.

## 2:3 TECHNICAL DATA

Dimensions:	Height	Width	Length
Boiler dimensions:	305 mm	340 mm	490 mm
Rec. min. installation dimensions:	310 mm	400 mm	500 mm

Weight:	14 kg (without fluid)	
Gas:	Propane	Butane
Output Stage 1:	3.3 kW	3.8 kW
Consumption:	245 g/h	275 g/h
Output Stage 2:	5.5 kW	6.4 kW
Consumption:	405 g/h	460 g/h
Gas pressure:	I <sub>3+</sub> 28–30/37 mbar	
	I <sub>3B/P</sub> 30 mbar	

Fluid volume/pressure	
Fluid volume, ethylene glycol fluid:	3.5 litres
Fluid volume, fresh water:	8.4 litres
Max pressure, heating system:	0.05 MPa (0.5 bar)
Max pressure, fresh water:	0.3 MPa (3.0 bar)
System temperature:	85°C max.

230 V ~	
Output, element:	1 x 1050 W
(2 or 3 kW)	1 x 2100 W

12 V DC	
Power consumption:	1 amp (max.)
Fuse:	3.15 amp

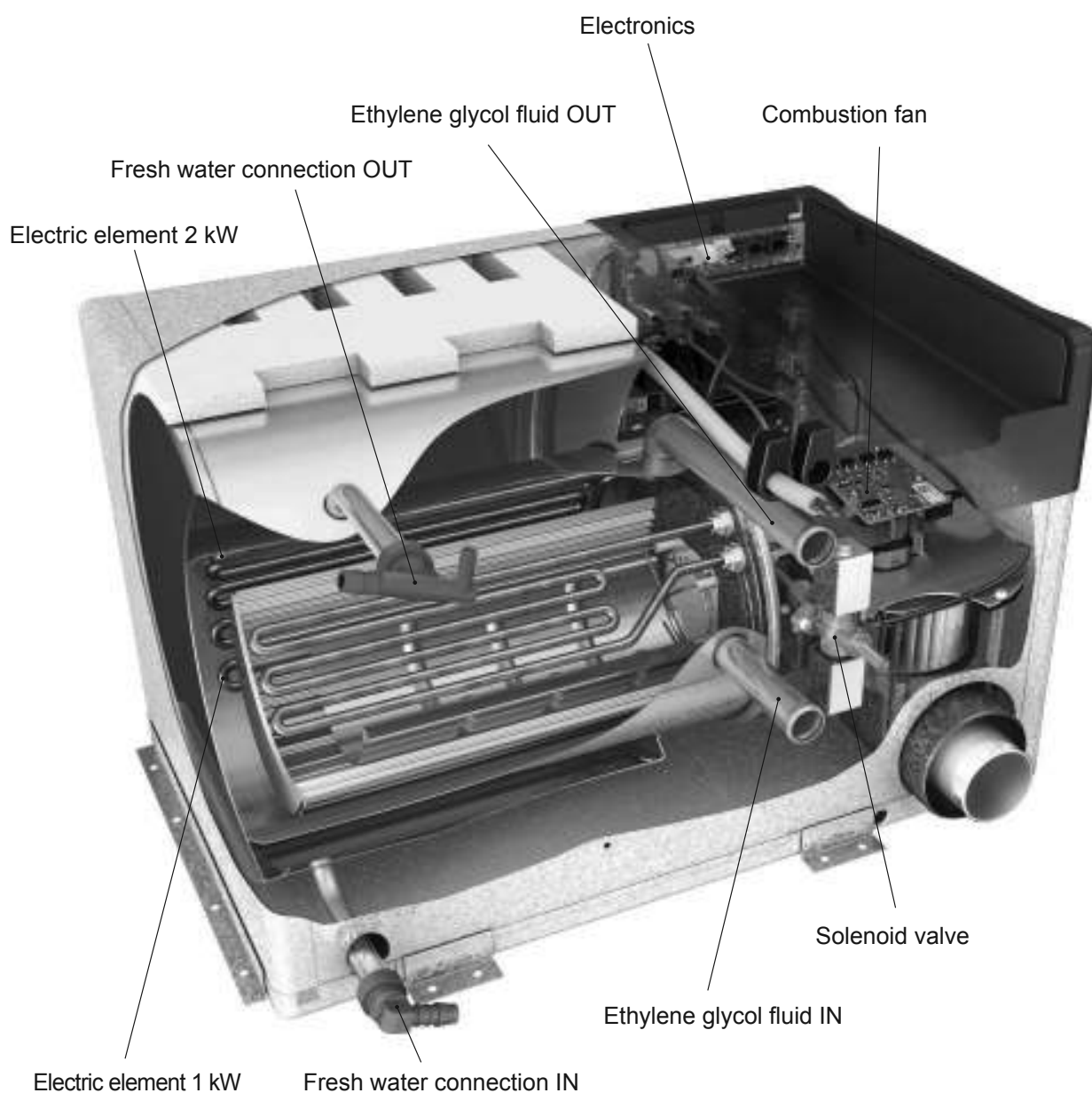

### 3. COMPONENT REPLACEMENT

#### **⚠ DANGER HIGH VOLTAGE 230 V**

- Always disconnect 12 V DC and 230 V ~ before commencing servicing.

#### **⚠ DANGER FIRE/EXPLOSION RISK**

- Close the main gas tap before commencing servicing.
- Do not use a naked flame when troubleshooting.
- Only Alde original parts may be used as spare parts.

#### 3:1 CIRCUIT BOARD REPLACEMENT

1. Remove the service hatch on the boiler.
2. Undo blue cable (marked S-5) (Fig. 1A), brown cable (marked S-1) (Fig. 1B), red cable (marked S-3) (Fig. 1C), grey cable (marked S-6) (Fig. 1D) and black cable (marked S-4) (Fig. 1E) on the circuit board, as well as blue (marked S-2) (Fig. 1F) and brown (marked S-7) (Fig. 1G) if the boiler is equipped with a 230 V circulation pump.
3. Remove the white 6-pole terminal block (Fig. 1H) (marked X10) from the sensors on the circuit board.
4. Remove the white 4-pole terminal block (Fig. 1I) (marked X12) from the fan on the circuit board.
5. Remove the white 6-pole terminal block (Fig. 1J) (marked X13) from the solenoid valve on the circuit board.
6. Remove the circuit board by pressing out the catches, x3 (Fig. 1N) and pulling up the circuit board.
7. Remove the sensor cable (Fig. 1L) and ignition cables (Fig. 1M) from the circuit board.
8. Remove the earth cable (Fig. 1K) (marked X17) on the board.
9. Press in the new circuit board and connect the cables as in Fig. 1 and Fig. 3. See also the wiring diagram page 17.
10. Fit the service hatch and test run on electricity and gas.  
**NB. Bear in mind the possibility of static electricity when handling the circuit board.**

#### CABLE MARKING FIG. 1

- 1A. Blue cable marked S-5 on the circuit board.
- 1B. Brown cable marked S-1 on the circuit board.
- 1C. Red cable marked S-3 on the circuit board.
- 1D. Grey cable marked S-6 on the circuit board.
- 1E. Black cable marked S-4 on the circuit board.
- 1F. Blue cable from pump marked S-2 on the circuit board.
- 1G. Brown cable from pump marked S-7 on the circuit board.
- 1H. White 6-pole (X10) terminal block from the sensors.
- 1I. White 4-pole (X12) terminal block from the fan.
- 1J. White 6-pole (X13) terminal block from the solenoid valve.
- 1K. Yellow/green (X17).
- 1L. Sensor cable (X16).

Fig 1.

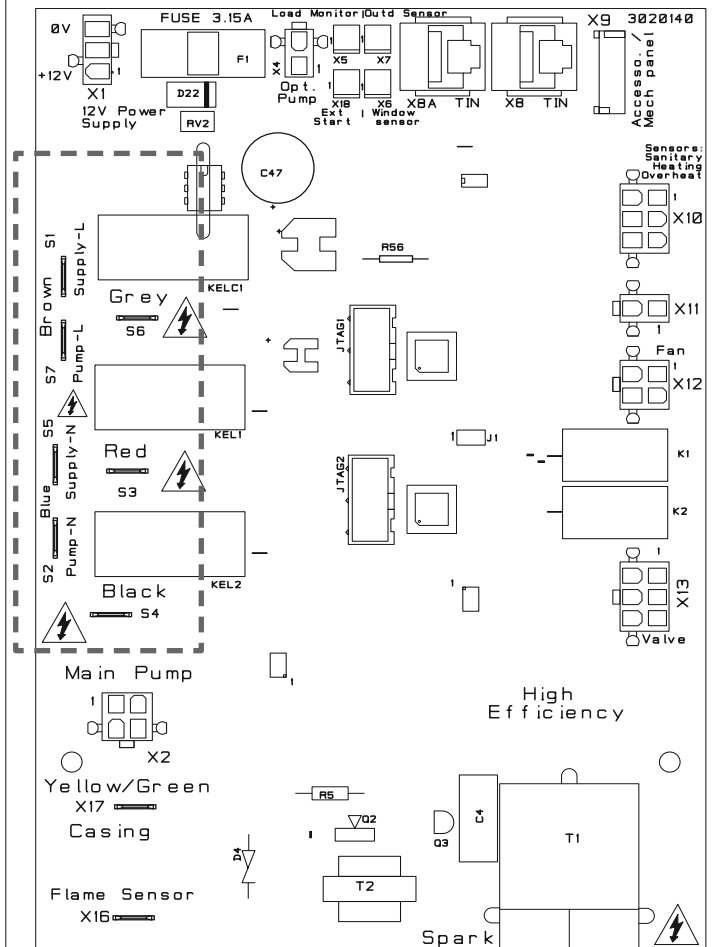
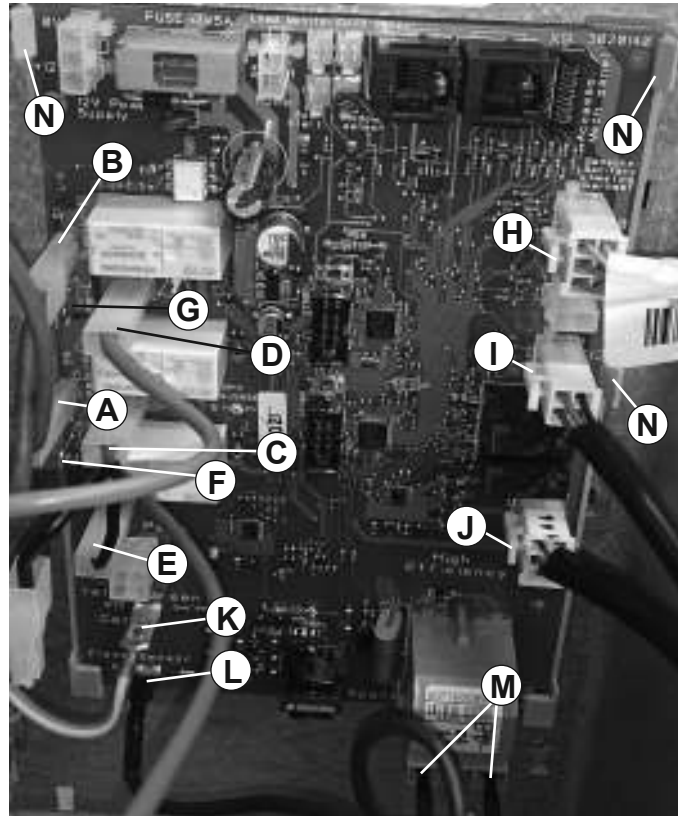

### 3:2 FAN REPLACEMENT

1. Remove the service hatch on the boiler.
2. Remove the cable from the fan motor by lifting the catch (Fig. 2A) and pulling the cable straight out.
3. Remove the four self-tapping screws (Fig. 2B) securing the fan in the fan housing.
4. Lift the fan from the boiler body.
5. Fit the new fan in reverse order.  
**NB. Take care not to damage the impeller when fitting.**
6. Fit the service hatch and test run the boiler.

### 3:3 BURNER REPLACEMENT

1. Remove the service hatch on the boiler.
2. Remove fan as per point 3:2.
3. Remove the sensor cable (Fig. 3A) and ignition cables (Fig. 3B) from the circuit board.
4. Remove the gas pipe (use holding tool) on the burner (Fig. 3C) and the solenoid valve (Fig. 6B).
5. Remove the three screws (Fig. 3D) holding the burner cover plate on the burner housing.
6. Pull the cover plate with burner upwards and outwards from the burner housing, see Fig. 4.
7. Fit the new burner in reverse order.
8. Tighten the gas pipe nuts (use holding tool) to the solenoid valve and burner to a torque of 7–9 Nm. Don't forget to check that the cones are correctly fitted on the pipe.  
**NB. Check that the system is sealed, and use leak spray to test that the couplings are sealed when the boiler is working.**
9. Connect the sensor cable and ignition cables on the circuit board.
10. Fit the service hatch and test run the boiler.

Fig 2.

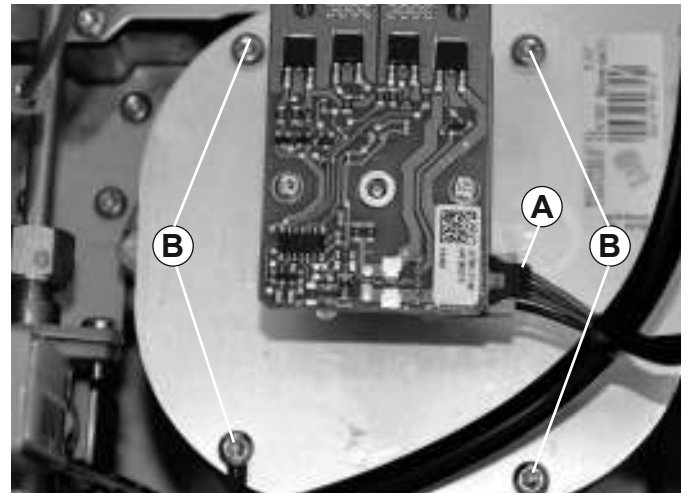

Fig 3.

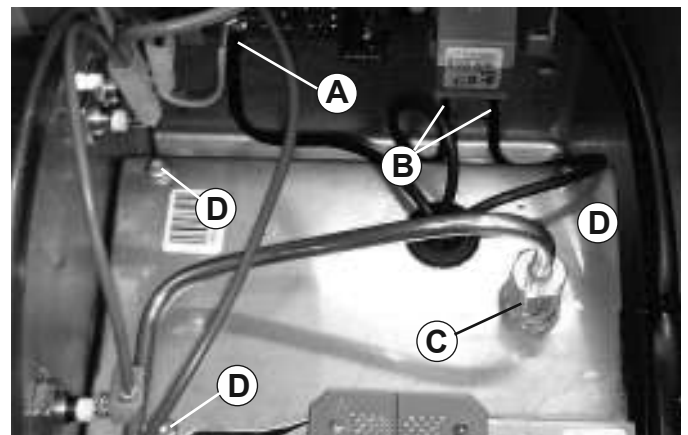

Fig 4.



For Alde instruction videos:  
Follow us on our YouTube channel  
**The King of Comfort**

For instruction videos for servicing and repairs of Alde heating systems, see:  
<https://www.youtube.com/user/aldeheating>



### 3:4 SPARK PLUG REPLACEMENT

When replacing the spark plug, the sensor should also be replaced.

1. Remove the burner as per point 3:3.
2. Remove the screws (Fig. 5A) and remove the spark plug (Fig. 5B).
3. Fit the new plug and screw tight. Check that the distance between the tips of the spark plug is 3.5–4.5 mm and that it is correctly positioned (see Fig. 5).
4. Fit the burner as per point 3:3 and test start the boiler.

### 3:5 SENSOR REPLACEMENT

When replacing the sensor, the spark plug should also be replaced.

1. Remove the burner as per point 3:3.
2. Remove the screw (Fig. 5C) and remove the sensor (Fig. 5D).
3. Fit the new sensor so that its tip is above the burner as shown in Fig. 5 and screw tight.
4. Fit the burner as per point 3:3 and test start the boiler.

### 3:6 SOLENOID VALVE REPLACEMENT

1. Remove the service hatch on the boiler.
2. Remove the terminal block (Fig. 1J) from the circuit board.
3. Unscrew the gas pipe (use holding tool) on the burner (Fig. 6A) and the solenoid valve (Fig. 6B).
4. Remove the three screws (Fig. 7A) to the solenoid valve attachment.
5. If necessary the upper coil can be unscrewed in order to facilitate removal of the solenoid valve. Unscrew the nut (Fig. 7B).
6. Remove the plate over the coil (Fig. 7C) and lift out the upper coil (Fig. 8A) on the solenoid valve.
7. Lift up the solenoid valve and fit the new one in reverse order. Check that the cable to the upper coil is in the groove in the plate (Fig. 8B).
8. Tighten the gas pipe nuts (use holding tool) to the solenoid valve (Fig. 6B) and burner (Fig. 6A) to a torque of 7–9 Nm. Don't forget to check that the cones are correctly fitted on the pipe.
9. Check that the system is sealed, and use leak spray to test that the couplings are sealed when the boiler is working.
10. Fit the service hatch.

Fig. 5.

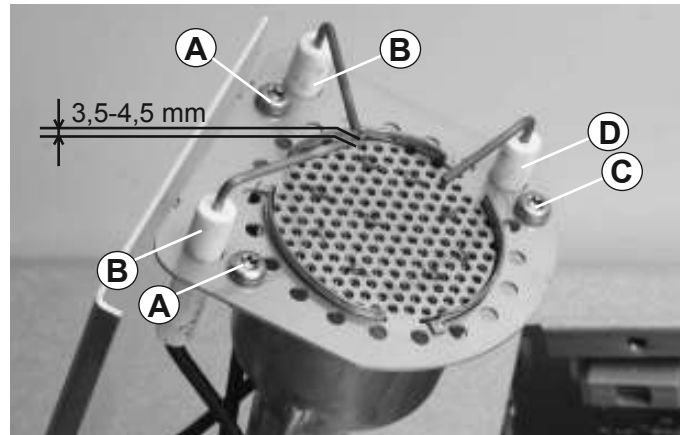

Fig. 6.

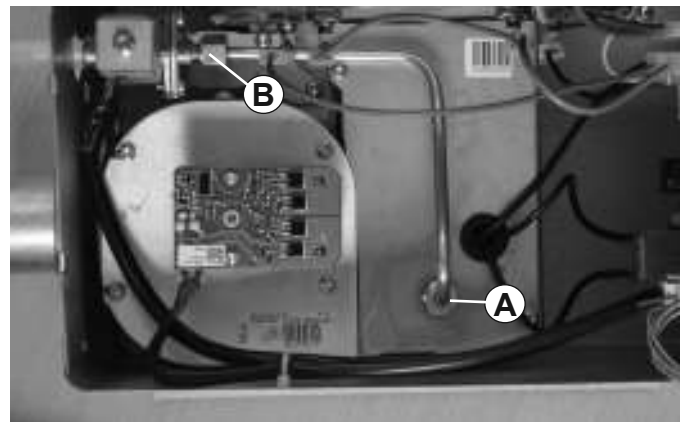

Fig. 7.

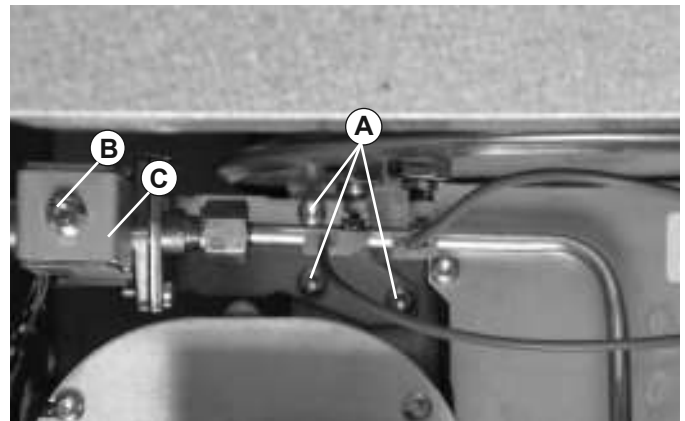
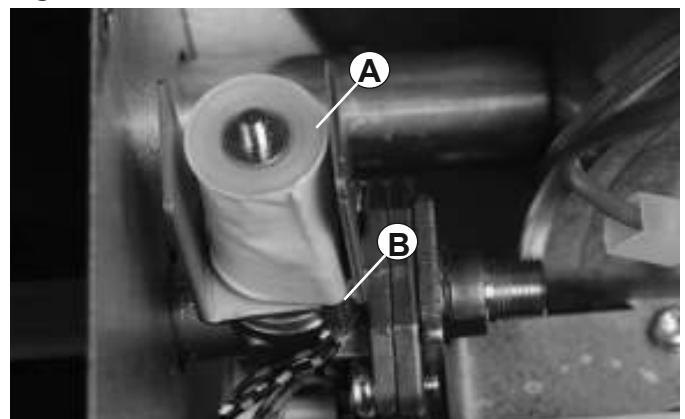

Fig. 8.



### 3:7 SENSOR REPLACEMENT

1. Remove the service hatch on the boiler.
2. Remove the 6-pole terminal block (Fig. 9A) from the circuit board.
3. Remove the connection cables from their groove (Fig. 9B) on the circuit board attachment.
4. Remove the nut which holds the operating thermostat (blue cable) (Fig. 10B) and overheating protection (red cable) (Fig. 10A) from the boiler body.
5. Remove the nut which holds the domestic hot water thermostat (grey cable) (Fig. 10C) on the boiler body.
6. Remove the sensors together.
7. Fit the sensors in reverse order;  
**tighten the nuts to a torque of 0.6 Nm.**
8. Fit the service hatch and test run the boiler.

Fig. 9.

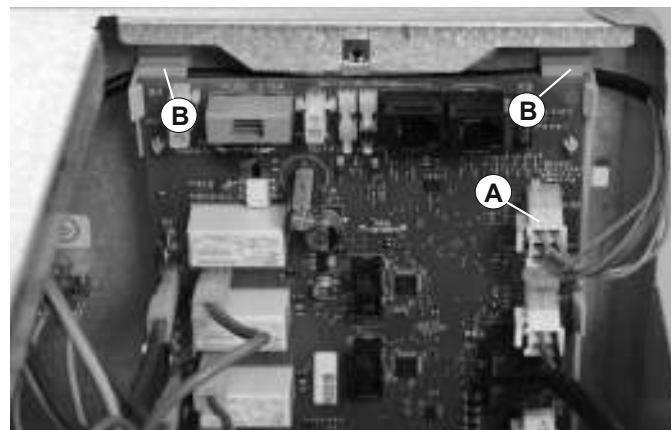
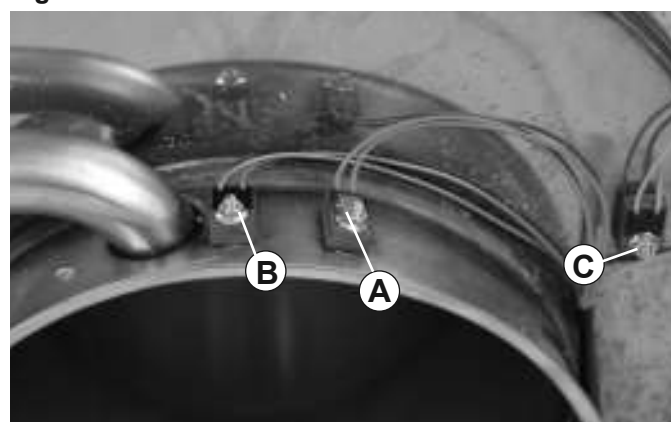

Fig. 10.



## 4. ERROR MESSAGE ON THE CONTROL PANEL

**NB.** An error message is only displayed when the control panel is in standby mode (only applies to touch panels for 3020). “Gas failure” is reset by switching off the main switch and switching it back on. Other error messages are reset by disconnecting the main current for 12 volts and reconnecting it again. If an AC system is installed and connected to the boiler/panel, the 230 V supply must also be disconnected to remove the error message.

### GAS FAILURE

#### Caused by:

The boiler has performed repeated attempts to ignite the burner without the electronics receiving a signal from the sensor which monitors the flame.

**The boiler performs a full start attempt. An ignition spark and click from the gas valve are audible.**

#### Likely causes of the fault:

- No gas supply or gas pressure too low.
- Damaged or incorrectly installed spark plug.
- Dirt in the boiler’s gas lines or jet.

#### Action:

- Check that all gas taps are open and functioning properly.
- Check the cylinder pressure reducing valve. Replace the pressure reducing valve or check if the stove top is functioning correctly. (Air in the cylinder).
- Check that the ignition cables are connected at the circuit board and there is no flashover along the cables.
- Remove the burner. Check that the spark gap is 4 mm.
- Perform a start attempt and check the spark with the burner removed. NB. Refit the fan and shut off the gas.
- Clean the jet and gas line.

**The boiler performs a full start attempt, but no click is audible from the gas valve.**

#### Likely causes of the fault:

- The gas valve is not opening.
- The electronics are not sending a signal to the gas valve.

#### Action:

- Check the gas valve’s connection contact on the circuit board (JP8).
- Check on start-up that there is a signal between 6 and 5 (approx. 2 seconds).
- Check the resistance of the pull coil (resistance of 8  $\Omega$  between 6 and 5).
- Tap gently on the valve on start-up.

**The boiler performs a full start attempt, but no ignition spark is audible.**

#### Likely causes of the fault:

- No spark from the electronics.

#### Action:

- Remove the ignition cables at the electronics and perform a new start attempt.
- If no spark is audible, replace the circuit board.

**The boiler ignites but goes out again.**

#### Likely causes of the fault:

- Gas pressure too low:
- Exhaust gas/intake hoses damaged or incorrectly fitted.
- The gas valve opens but closes again.
- Dirt in the boiler’s gas lines or jet.
- Damaged or incorrectly fitted sensor.
- The sensor circuit in the electronics is not working.

#### Action:

- Check that all gas taps are open and functioning properly.
- Check the cylinder pressure reducing valve. Replace the pressure reducing valve or check if the stove top is functioning correctly.
- Check the hoses and connections between flue and boiler.
- Check the gas valve’s connection contact on the circuit board (JP8).
- Check on start-up that there is a signal between 1 and 5 at contact JP8.
- Check that the hold circuit’s resistance is 310  $\Omega$  between 6 and 5.
- Clean the jet and gas line.
- Check that the sensor cable is connected on the circuit board (JP7).
- Remove the burner and check the sensor plug.
- Replace the circuit board.

**The fan runs for a short time.**

#### Likely causes of the fault:

- Contact fault in the overheating sensor.

#### Action:

- Measure the resistance in sensor no. 2 (red cable). Must be a closed contact; if interrupted, the sensor is broken.

## OVERHEAT BLUE FAIL

### Caused by:

The blue sensor on the boiler body (thermostat) has recorded a temperature over 95°C or contact fault.

### Likely causes of the fault:

- Air in the heating system.
- Poor circulation or the pump is not working.
- The sensor is damaged.
- Temperature measurement of the electronics is not working.

### Action:

- Bleed and check the ethylene glycol fluid level.
- Check the pumps are working
- Measure the resistance in the blue sensor. It should be 10,000 ohms at 25°C, with the value increasing as temperature increases. A too low value will not result in a fault signal and will reset itself.
- Measure the voltage with the sensor fitted.

## OVERHEAT RED FAIL

### Caused by:

The red sensor on the boiler body (the overheating protection) has recorded a temperature over 95°C or contact fault.

### Likely causes of the fault:

- No circulation means air in the system, alternatively poor or no circulation in the heating system (the circulation pump).
- Low fluid level in the heating system.

### Action:

- Bleed the system.
- Check to make sure that the circulation pump is working.
- Check the fluid level in the expansion tank.

## FAN FAILURE

### Caused by:

The fan has the wrong speed or no contact with the electronics.

### Likely causes of the fault:

- Break in cable between fan and circuit board.
- Fault in the fan.
- Monitoring on the circuit board not working.

### Action:

- Check that the cable between the fan and the electronics is connected and intact.
- Replace the fan.
- Replace the circuit board.

## BATTERY TOO LOW

### Caused by:

The voltage at the boiler is below 10.5 volts.

### Likely causes of the fault:

- The battery is discharged.
- Contact fault in the cabling to the boiler.
- The boiler is drawing abnormally high current.
- Fault in the circuit board.

### Action:

- Check the voltage at the battery. In a no-load state, it should be more than 12.2 volts.
- Measure the voltage to the boiler. With the burner in operation, it should be more than 10.5 volts.
- Measure the boiler's power consumption on operation. It should be 0.3 A on stage 1 and 0.6 A on stage 2.

## WINDOW OPEN

### Caused by:

Connection on the circuit board is broken.

If this is broken, the boiler will not work on LPG.

Usually this function is used to interrupt LPG heating if a window is opened which is fitted near the wall flue. If the function is not to be used, a bridge must be fitted.

### Likely causes of the fault:

- Break in the cable with the circuit board.
- Damaged or incorrectly fitted window contact.
- Incorrectly fitted or missing bridge.

## CONNECTION FAILURE

### Caused by:

A communication fault between the boiler and control panel.

### Likely causes of the fault:

- Break in the cables for data communication between the boiler and control panel.
- The ignition spark is striking earth and interfering with communication.
- Some other electrical device is interfering with communication.

## CONTROL PANEL DISPLAYS:

### Panel failure 1

- Fault in control panel.

### Panel failure 2

- Fault in control panel.

### 3RD PARTY PANEL CONNECTION FAILURE

#### Likely cause of the fault:

- Contact fault between panel and external panel.

Wrong selection of external panel in the panel, see separate operating instructions for the Alde Compact 3020 HE.

### NO MATCH HEATER/PANEL

- The control panel is not compatible with the boiler's circuit board.
- Check the product number of the control panel. The 3020 013 control panel is for the 3020 A series boiler, the 3020 113 is for the 3020 HE series boiler.

### OTHER FAULTS NOT INDICATED IN THE CONTROL PANEL

#### Boiler not working at all and the control panel is not lit.

- 12-volt fuse has tripped. See the wiring diagram on page 17 of the service manual.

#### The boiler goes out when it is meant to switch between stages.

- Leak between the exhaust gas and intake hose.
- Insufficient supply of gas.
- The gas valve is not opening at stage 2.

#### No electric power

- 230 volts is not connected or the fuse has tripped.
- Load monitor incorrectly set. If the load monitor has a large measurement error it can affect the electric power even if it is switched off in the control panel.
- One of the 230-volt relays is not working.

#### No heating in the vehicle despite the control panel being correctly set.

- One of the circulation pumps is not working.
- Air in the heating system.

#### Poor heating control.

- The control panel or remote sensor is not located in a suitable position.

If an AC system is connected up with the Alde central heating system (automatic climate control), i.e. if it seems to be giving poor control or not switching well between heating/cooling, you should make sure the temperature sensor "detects" heat and cold to more or less the same degree. In such a case it may be better to use the rectangular sensor instead of the round one, as the rectangular one is more sensitive to changes in temperature. You should also make sure the AC blowers are not pointing in an unsuitable direction.

### No domestic hot water.

- Continuous pump operation is activated, see separate operating instructions for the Alde Compact 3020 HE.
- Fault on domestic hot water sensor (grey cable).
- No domestic hot water selected in the panel, see separate operating instructions for the Alde Compact 3020 HE.
- This may also be caused by the fact that day mode or night mode is in operation and the option of shutting down the domestic hot water has been selected.

### Control panel displays:

#### +70°C Indoor temperature

- Short circuit in the sensor in the control panel or in the remote sensor.

#### - 45°C Indoor temperature

- Failure in the sensor in the control panel or in the remote sensor.

#### - 41°C Outdoor temperature

- Short circuit in outdoor sensor.

## 5. SAFETY CHECKS

Safety checks must be performed after each service intervention.

#### Check:

- That the intake/exhaust gas hoses and flue do not leak and are undamaged.
- That the LPG lines have no leaks. Check the system for leaks.
- That the 230 V ~ earth cable is connected.
- That the safety valve on the hot water heater has not jammed.
- That the heating system has been filled with ethylene glycol fluid to the mark on the expansion tank.

## 6. EXPLODED DRAWING

- |     |          |                                 |     |          |                              |
|-----|----------|---------------------------------|-----|----------|------------------------------|
| 1.  | 3020 011 | Service cover                   | 19. | 3010 133 | Spark plug                   |
| 2.  | 3020 010 | Service hatch                   | 20. | 3010 186 | Nut                          |
| 3.  | 3010 152 | Cowling                         | 21. | 3010 181 | Screw                        |
| 4.  | 3020 040 | Circuit board 3 kW for model A  | 22. | 3010 134 | Sensor plug                  |
|     | 3020 140 | Circuit board 3 kW for model HE | 23. | 3010 122 | Burner                       |
| 5.  | 3020 039 | Sensor set                      | 24. | 3010 301 | Burner, complete             |
| 6.  | 3010 189 | Circuit board holder, LH        | 25. | 3010 150 | End panel, front             |
| 7.  | 3010 188 | Circuit board holder, RH        | 26. | 3010 141 | Element, 2 kW                |
| 8.  | 3010 163 | Nut                             | 27. | 3010 136 | Gasket                       |
| 9.  | 3010 164 | Cone                            | 28. | 3000 140 | Element, 1 kW                |
| 10. | 3010 304 | Solenoid valve                  | 29. | 3010 153 | Bottom plate                 |
| 11. | 3010 182 | Screw                           | 30. | 3010 200 | Clamping ring                |
| 12. | 3010 312 | Copper pipe                     | 31. | 3020 001 | Boiler body                  |
| 13. | 3010 182 | Screw                           | 32. | 3010 158 | Insulation                   |
| 14. | 3000 452 | Fan, complete                   | 33. | 3010 151 | End panel, rear              |
| 15. | 3010 182 | Screw                           | 34. | 3010 131 | Nipple                       |
| 16. | 2930 235 | Cable grommet                   | 35. | 3010 159 | Support for non-return valve |
| 17. | 3010 166 | Nut                             | 36. | 2762 125 | Strain relief                |
| 18. | 3010 135 | Plate                           |     |          |                              |

### Other small parts

- |          |               |
|----------|---------------|
| 3010 205 | Cable for fan |
|----------|---------------|

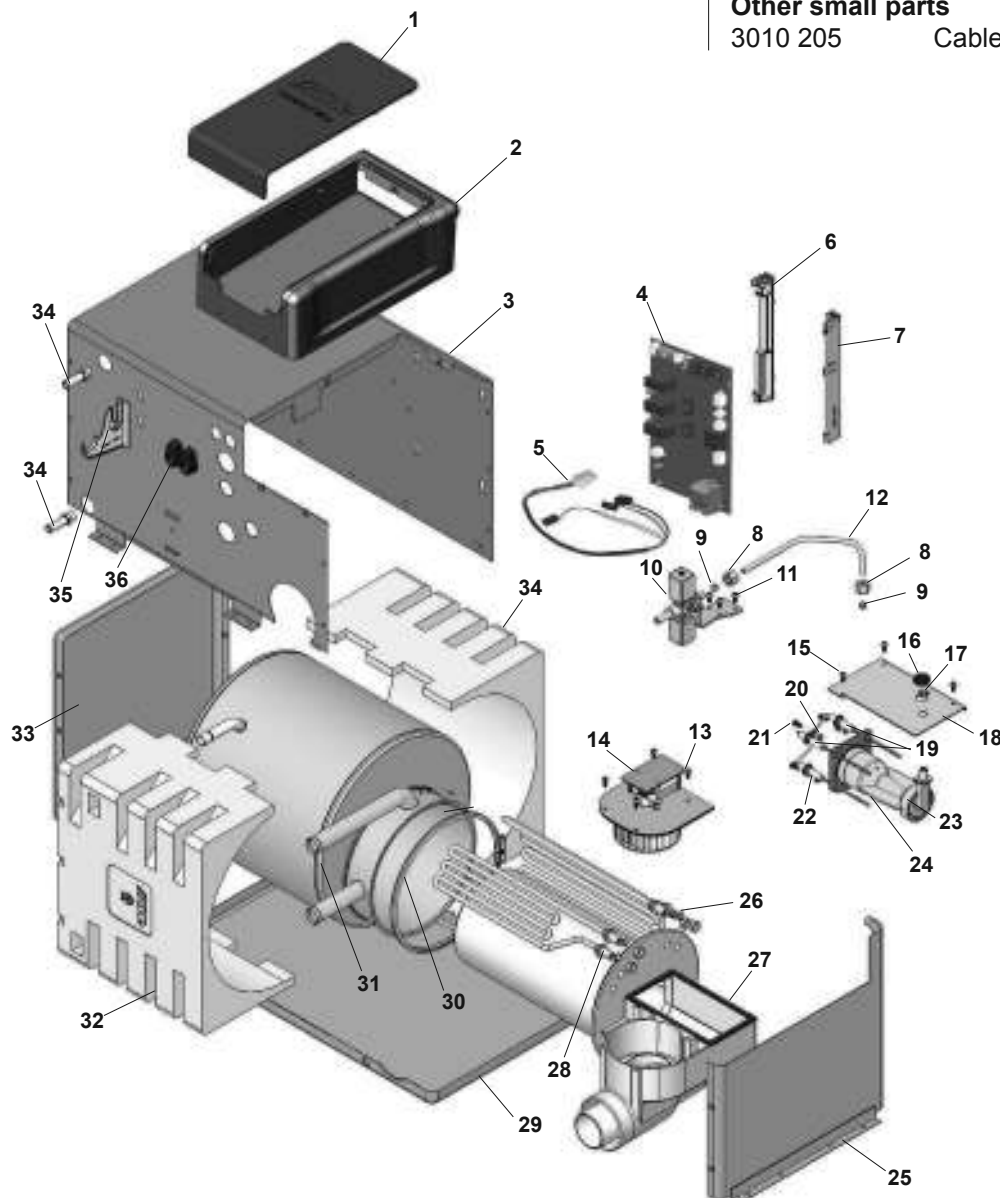

**7. SPARE PARTS**



**1. 3000 452** Fan, complete

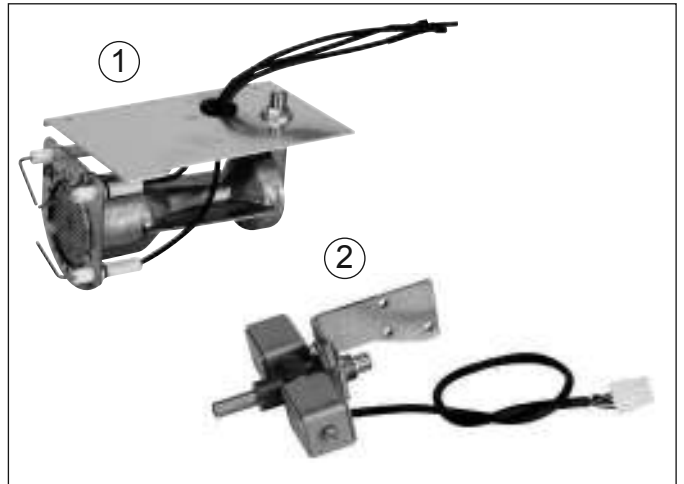

**1. 3010 301** Burner, complete  
**2. 3010 304** Solenoid valve, complete

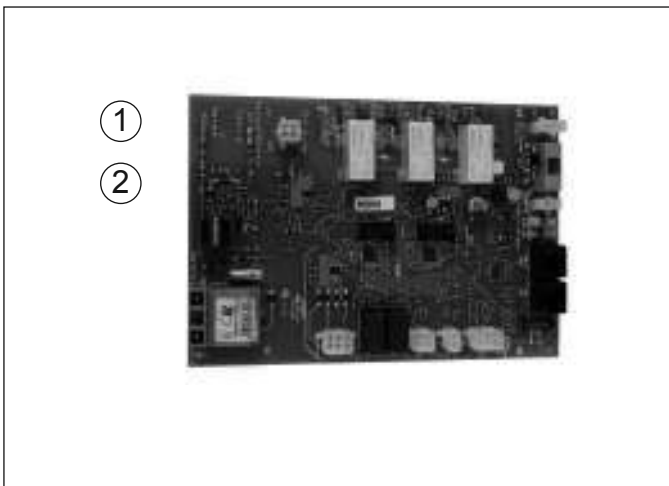

**1. 3020 040** Circuit board 3 kW for model A  
**2. 3020 140** Circuit board 3 kW for model HE (marked High Efficiency)

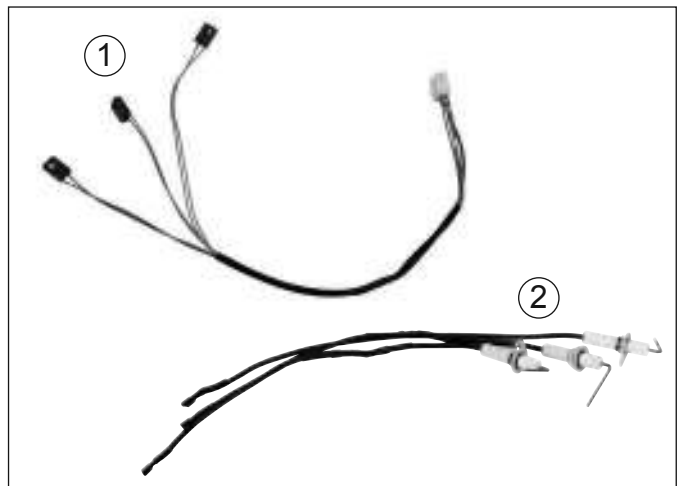

**1. 3020 039** Sensor 3020 spare part  
**2. 3010 306** Spark plug/Sensor plug

# 8. COMPONENT AND WIRING DIAGRAM

Control panel rear

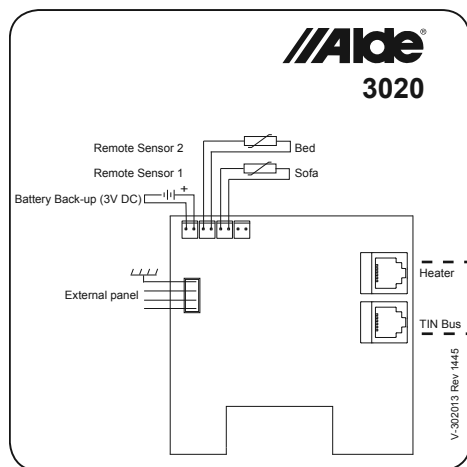

Circuit board on Compact 3020 HE boiler

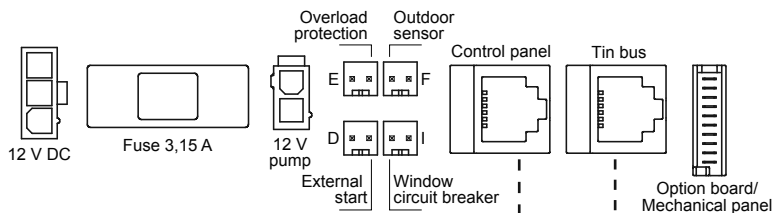

**\*Truma AC is connected to one of the TIN Bus contacts.**  
**-Aventa comfort**  
**-Aventa eco**  
**-Saphir comfort RC**  
**-Saphir compact (Serial No. > 23091001)**  
*Saphir compact also needs a Truma adapter 40090-69300*

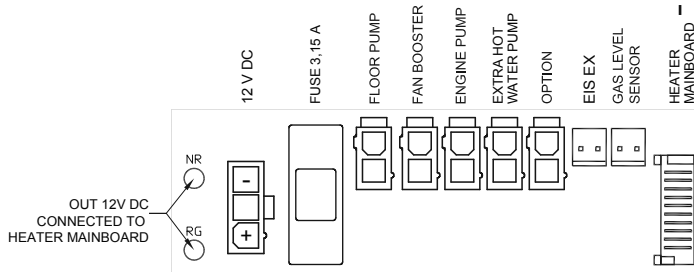

Mechanical panel 3010 214

Optional board for Compact 3020

S1, S2: 230Vac Pump connection  
 2 x 6,35 PCB tags  
 S3, S4, S5, S6, S7: Electrical power resistors  
 connection and 230Vac supply  
 5 x 6,35 PCB tags

