

24 BAKER ST., P.O. BOX 100, HASTINGS ON HULL - 1Y0  
 705-696-2385, 1-800-465-3433, FAX 705-696-1922

14'X25' R.H. CAPRI

QTY.	LENGTH	RADIUS	TYPE
1	8'0"	7'0"	RETURN
2	8'0"	7'0"	PLAIN
1	2'2"	7'0"	PLAIN
2	3'2"	2'0"	CORNER
1	10'0"	NA	SKIMMER
1	8'0"	NA	PLAIN
1	8'0"	NA	RETURN
1	7'0"	NA	PLAIN
1	3'0"	NA	PLAIN
1	6'X6'	NA	225° REV CORNER
10	-	NA	A-FRAME
1	-	NA	N&B PKG
			S.A.: 302 sq.ft.
			PER: 69'6"
1425CPRC			DATE: 09-11-00

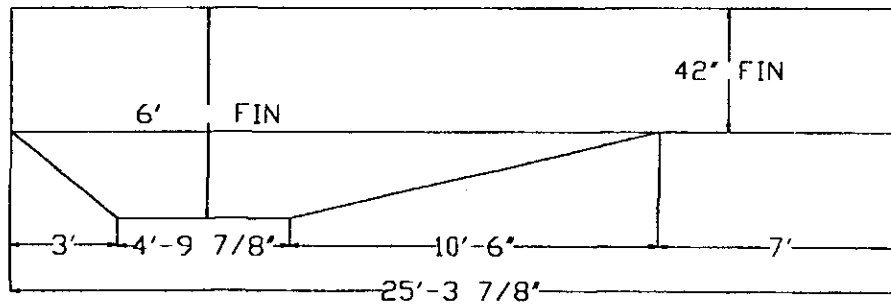

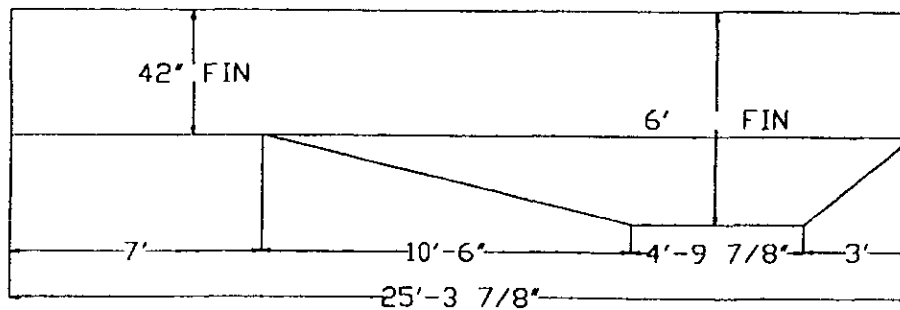
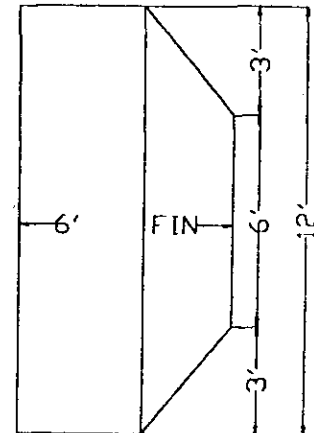
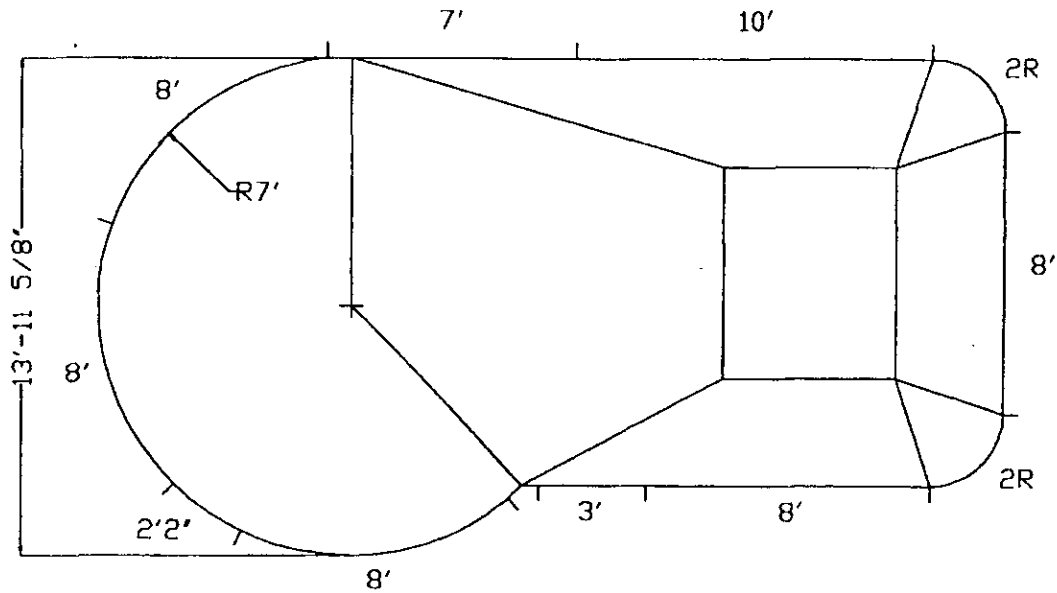

24 BAKER ST., P.O. BOX 100, HASTINGS ON KOL. - 1Y0  
 705-696-2385, 1-800-465-3433, FAX: 705-696-1922

14'X25' L.H. CAPRI

QTY.	LENGTH	RADIUS	TYPE
1	8'0"	7'0"	RETURN
2	8'0"	7'0"	PLAIN
1	2'2"	7'0"	PLAIN
2	3'2"	2'0"	CORNER
1	10'0"	NA	SKIMMER
1	8'0"	NA	PLAIN
1	8'0"	NA	RETURN
1	7'0"	NA	PLAIN
1	3'0"	NA	PLAIN
1	6'X6'	NA	225° REV CORNER
10	-	NA	A-FRAME
1	-	NA	N&B PKG
			S.A: 302 sq.ft.
			PER: 69'6"
1425CPRC			DATE: 09-11-00

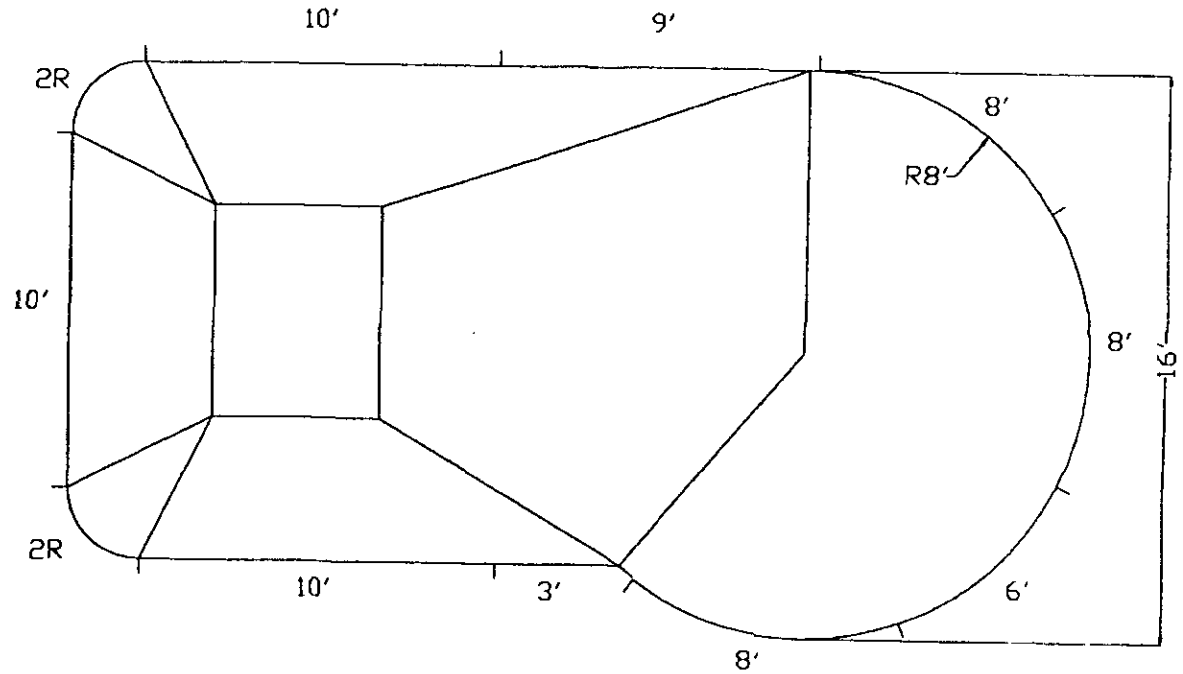
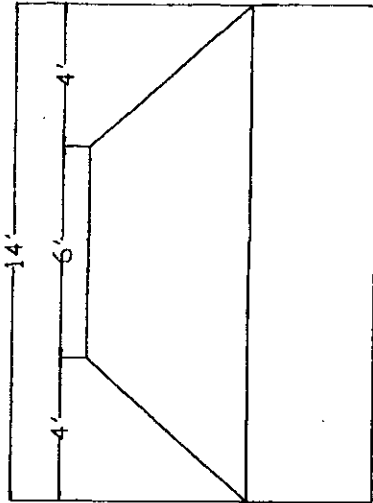

24 BAKER ST. P.O. BOX 100, HASTINGS DN. KOL - 1Y0  
 705-696-2385, 1-800-465-3433, FAX: 705-696-1922

**16' X 29' R.H. CAPRI**

QTY.	LENGTH	RADIUS	TYPE
1	8'0"	8'0"	RETURN
2	8'0"	8'0"	PLAIN
1	6'0"	8'0"	PLAIN
2	3'2"	2'0"	CORNER
1	10'0"	NA	SKIMMER
1	10'0"	NA	RETURN
1	10'0"	NA	PLAIN
1	9'0"	NA	PLAIN
1	3'0"	NA	PLAIN
1	6'X6'	NA	225° REV CORNER
10	-	NA	A-FRAME
1 1	-	NA	N&B PKG
			S.A. 396 sq.ft
			PER: 79'4"
1629CPRC			DATE: 10-11-00

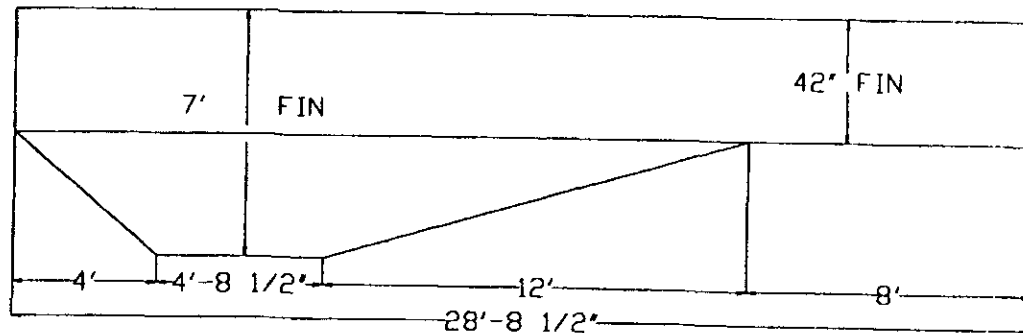

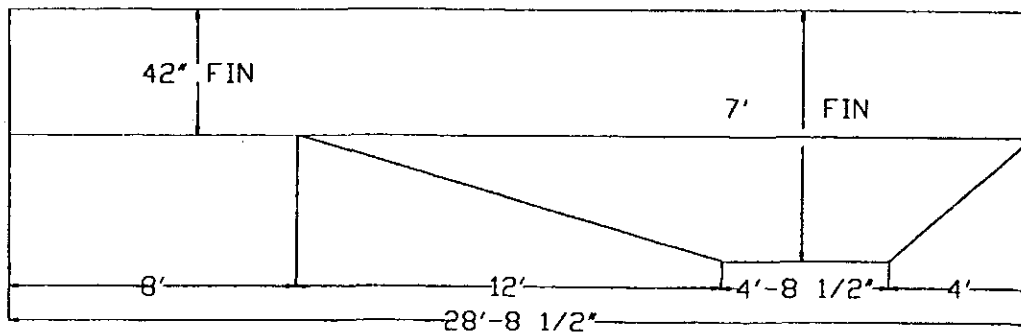
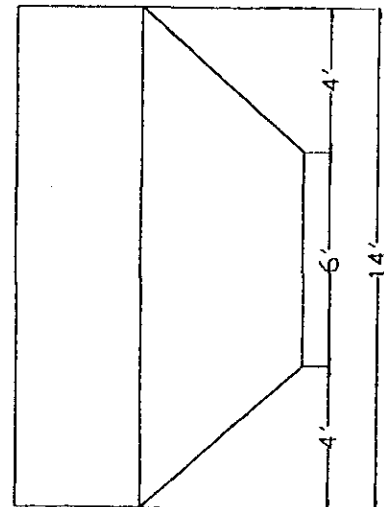
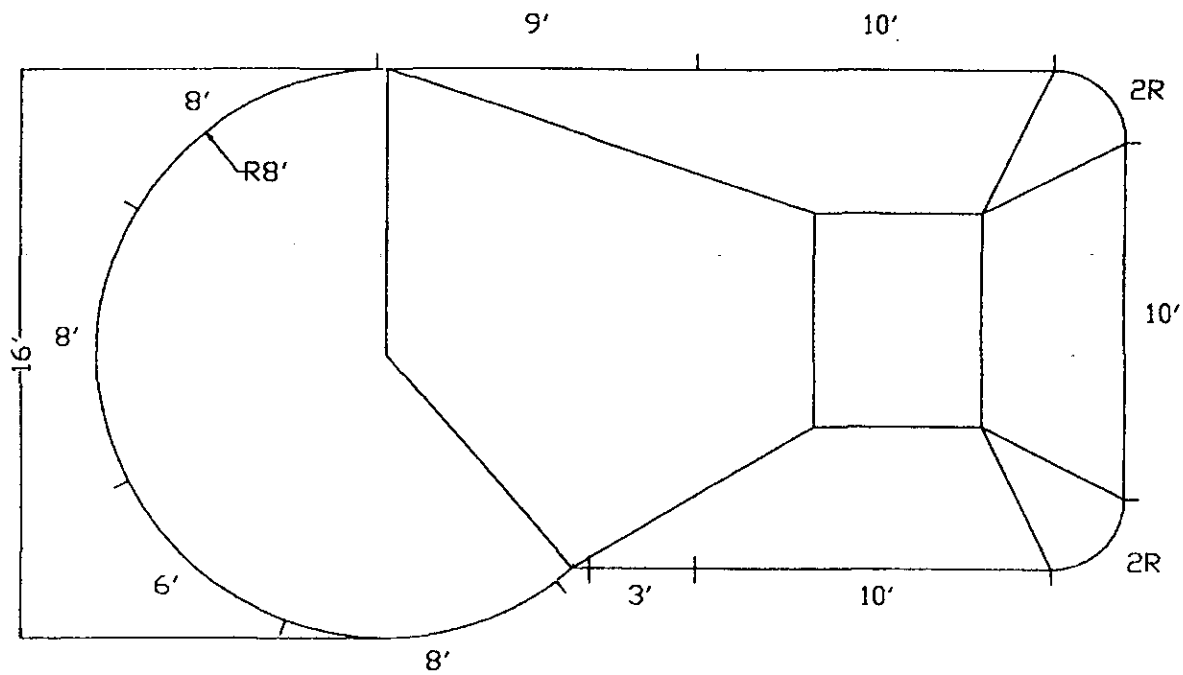

24 BAKER ST., P.O. BOX 100, HASTINGS ON KOL - 1Y0  
 705-696-2385, 1-800-465-3433, FAX: 705-696-1922

**16' X 29' L.H. CAPRI**

QTY.	LENGTH	RADIUS	TYPE
1	8'0"	8'0"	RETURN
2	8'0"	8'0"	PLAIN
1	6'0"	8'0"	PLAIN
2	3'2"	2'0"	CORNER
1	10'0"	NA	SKIMMER
1	10'0"	NA	RETURN
1	10'0"	NA	PLAIN
1	9'0"	NA	PLAIN
1	3'0"	NA	PLAIN
1	6'X6'	NA	225° REV CORNER
10	-	NA	A-FRAME
1	-	NA	N&B PKG
			S.A.: 396 sq.ft
			PER: 79'4"
1629CPRC			DATE: 10-11-00

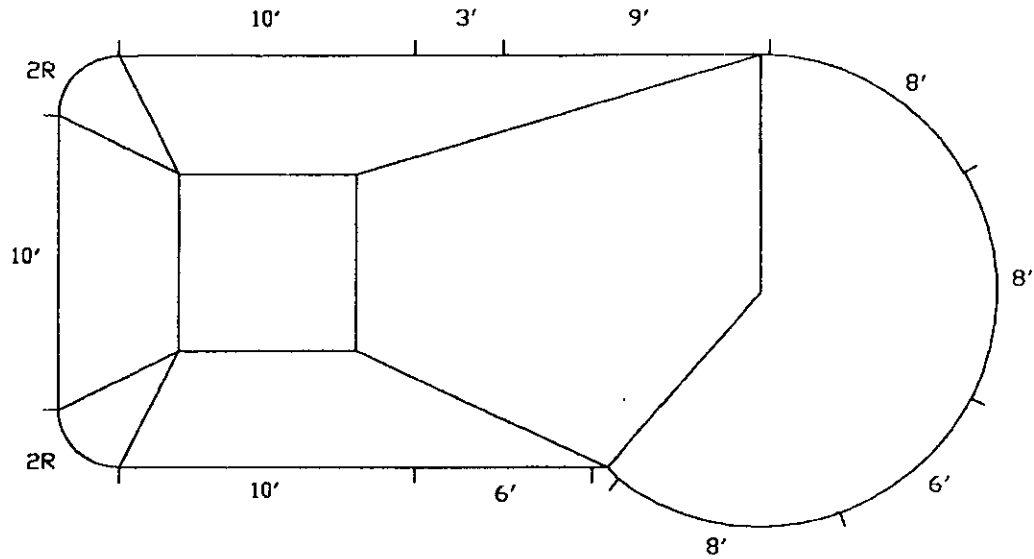
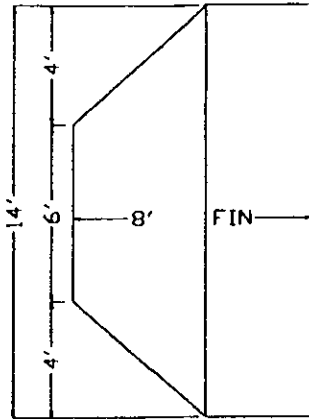

24 BAKER ST., P.O. BOX 100, HASTINGS DN. KOL. - 1Y0  
 705-696-2385, 1-800-465-3433, FAX: 705-696-1922

16' X 32' CAPRI R.H.

QTY.	LENGTH	RADIUS	TYPE
1	8'0"	8'0"	RETURN
2	8'0"	8'0"	PLAIN
1	6'0"	8'0"	PLAIN
2	3'2"	2'0"	CORNER
1	10'0"	NA	SKIMMER
1	10'0"	NA	RETURN
1	10'0"	NA	PLAIN
1	9'0"	NA	PLAIN
1	6'0"	NA	PLAIN
1	3'0"	NA	PLAIN
1	6'X6'	NA	225° REV CORNER
11	-	NA	A-FRAME
1	-	NA	N&B PKG
			S.A. 437 sq.ft.
			PER: 85'4"
1632CPRC			DATE: 03-06-03

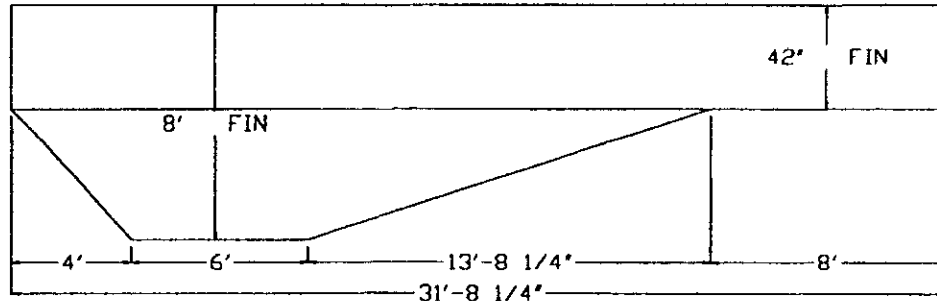

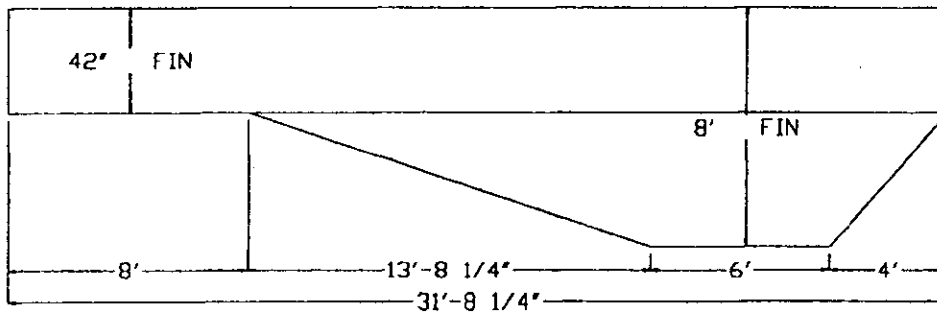
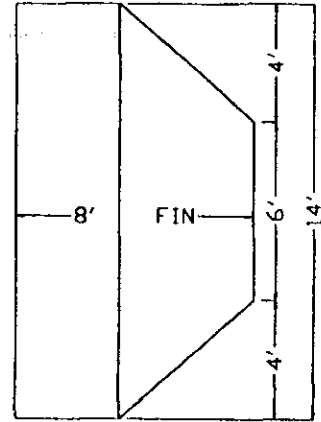
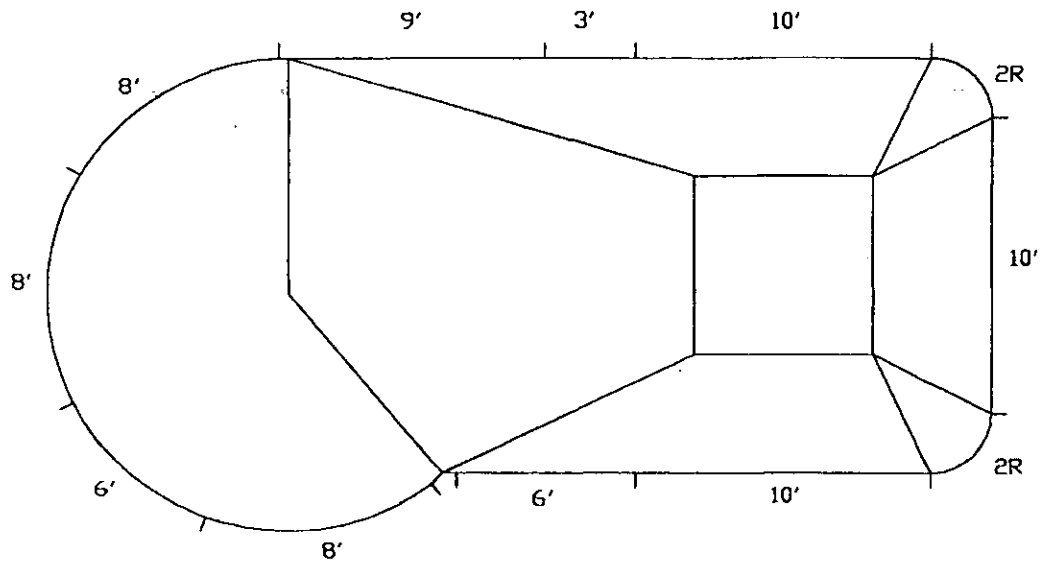

24 BAKER ST., P.O. BOX 100, HASTINGS DN, KOL-1Y0  
 705-696-2385, 1-800-465-3433, FAX: 705-696-1922

16' X 32' CAPRI L.H.

QTY.	LENGTH	RADIUS	TYPE
1	8'0"	8'0"	RETURN
2	8'0"	8'0"	PLAIN
1	6'0"	8'0"	PLAIN
2	3'2"	2'0"	CORNER
1	10'0"	NA	SKIMMER
1	10'0"	NA	RETURN
1	10'0"	NA	PLAIN
1	9'0"	NA	PLAIN
1	6'0"	NA	PLAIN
1	3'0"	NA	PLAIN
1	6'X6'	NA	225' REV CORNER
11	-	NA	A-FRAME
1	-	NA	N&B PKG
			S.A. 437 sq.ft.
			PER: B5'4'
1632CPRC			DATE: 03-06-03

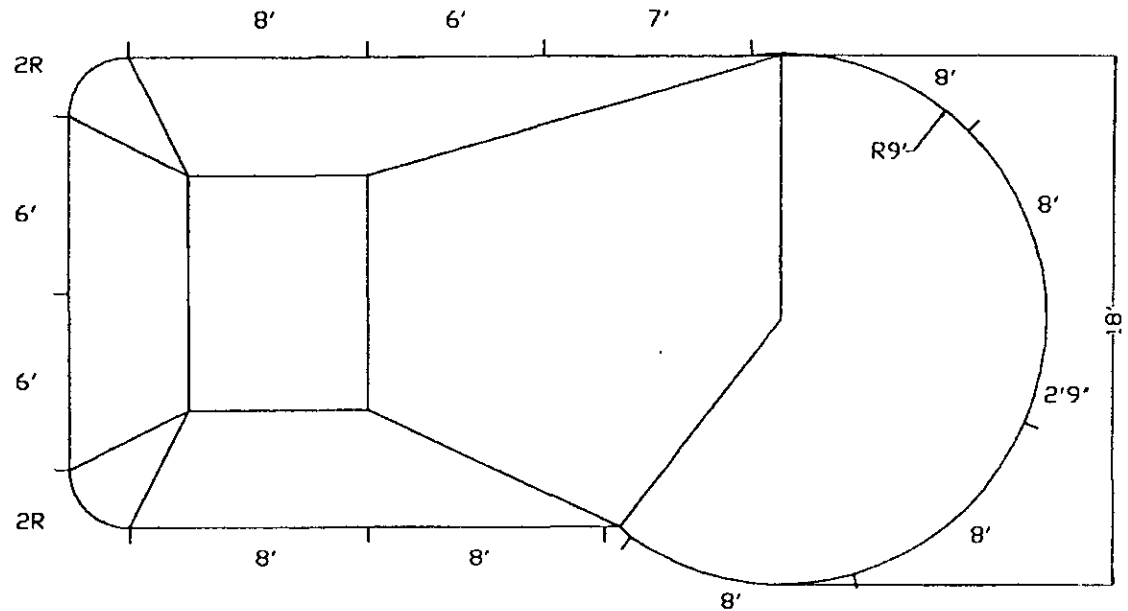
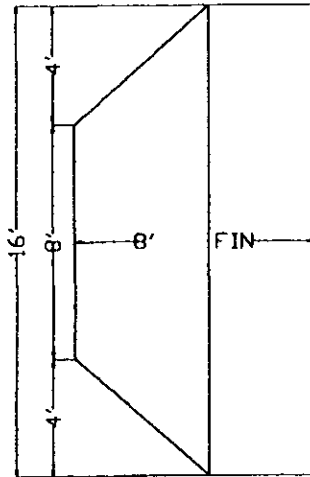

24 BAKER ST., P.O. BOX 100, HASTINGS ON KOL-1Y0  
 705-696-2385, 1-800-465-3433, FAX: 705-696-1922

**18'X33' R.H. CAPRI**

QTY.	LENGTH	RADIUS	TYPE
1	8'0"	9'0"	RETURN
3	8'0"	9'0"	PLAIN
1	2'9"	9'0"	PLAIN
2	3'2"	2'0"	CORNER
1	8'0"	NA	SKIMMER
2	8'0"	NA	PLAIN
1	7'0"	NA	PLAIN
1	6'0"	NA	RETURN
2	6'0"	NA	PLAIN
1	6'X6'	NA	225° REV CORNER
13	-	NA	A-FRAME
1	-	NA	N&B PKG
			S.A. 516 sq.ft.
			PER: 91'
1833CPRC			DATE: 10-11-00

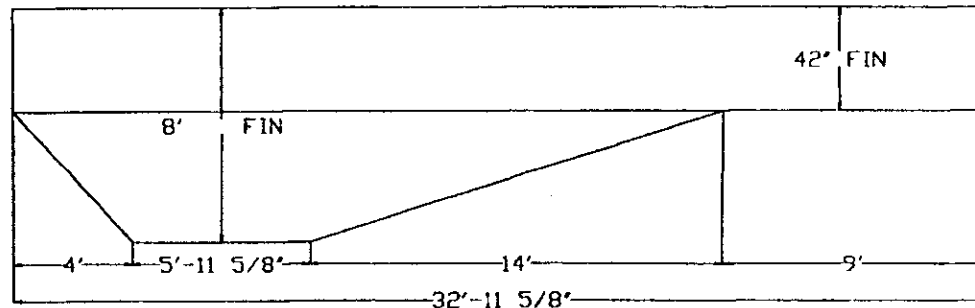

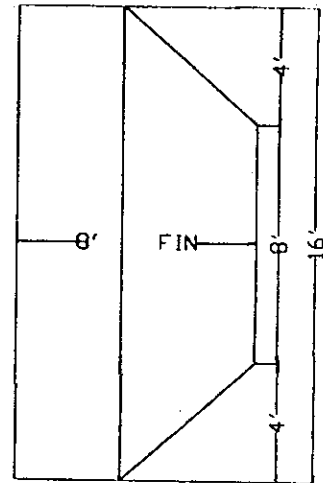
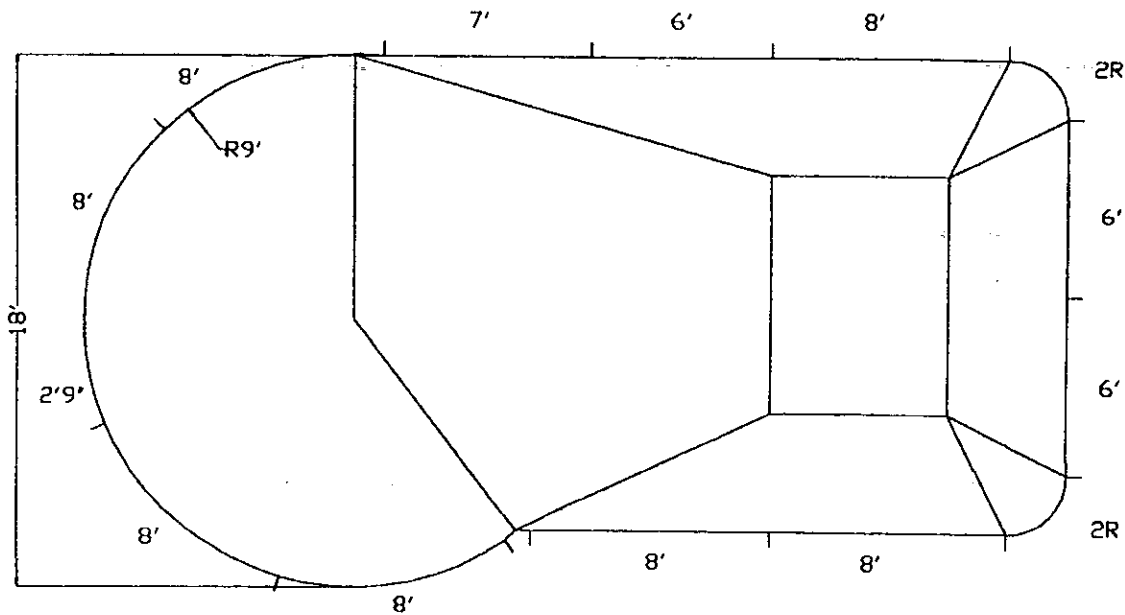

24 BAKER ST., P.O. BOX 100, HASTINGS DN, KOL-110  
 705-696-2385, 1-800-465-3433, FAX: 705-696-1922

**18' X 33' L.H. CAPRI**

QTY.	LENGTH	RADIUS	TYPE
1	8'0"	9'0"	RETURN
3	8'0"	9'0"	PLAIN
1	2'9"	9'0"	PLAIN
2	3'2"	2'0"	CORNER
1	8'0"	NA	SKIMMER
2	8'0"	NA	PLAIN
1	7'0"	NA	PLAIN
1	6'0"	NA	RETURN
2	6'0"	NA	PLAIN
1	6' X 6'	NA	225° REV CORNER
13	-	NA	A-FRAME
1	-	NA	N&B PKG
			S.A.: 516 sq.ft.
			PER: 91'
1833CPRC			DATE: 10-11-00

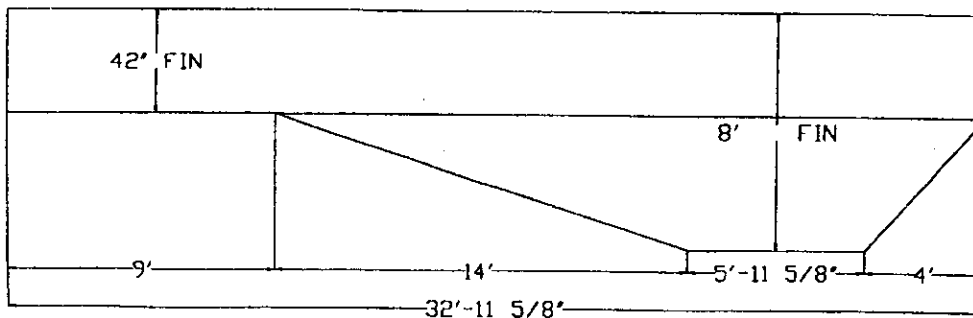



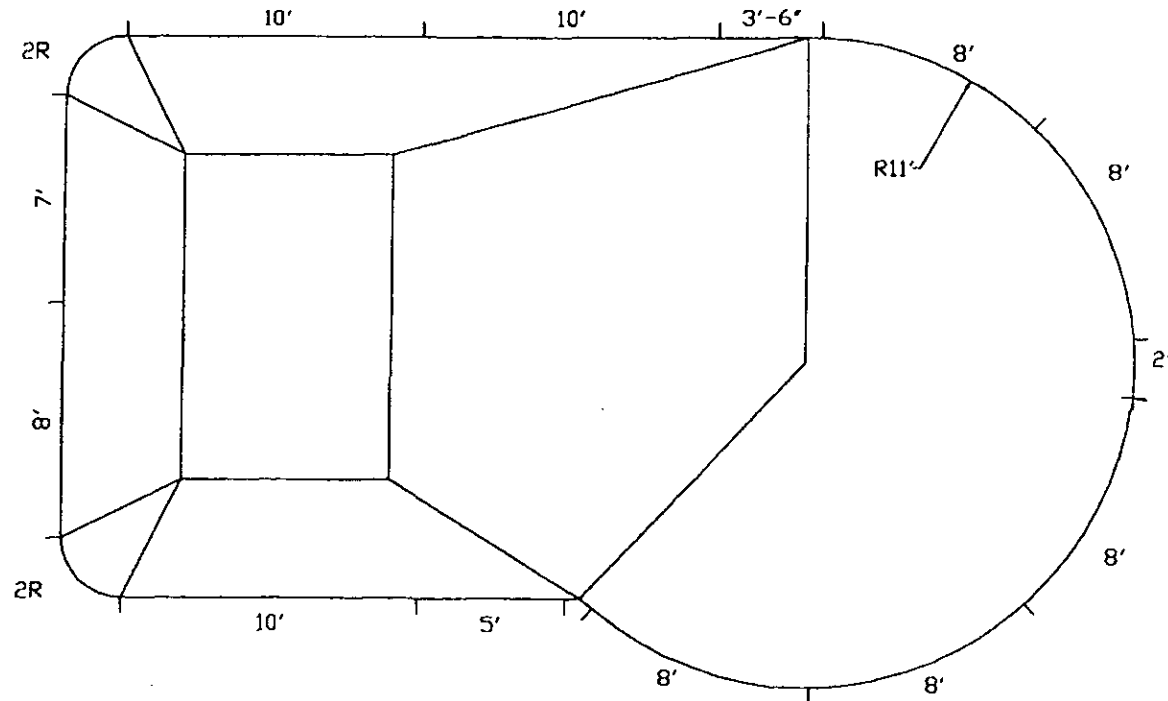
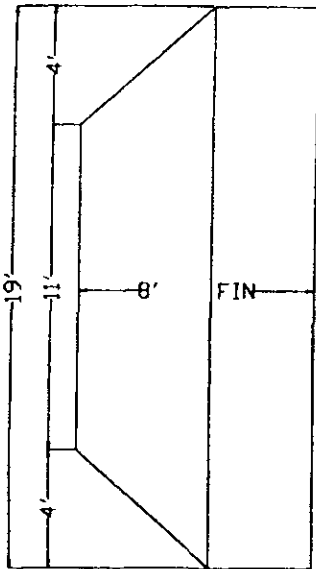

24 BAKER ST. P.O. BOX 100, HASTINGS ON KOL-1Y0  
 705-696-2385, 1-800-465-3433, FAX: 705-696-1922

**22'X36' R.H. CAPRI**

QTY.	LENGTH	RADIUS	TYPE
1	8'0"	11'0"	RETURN
4	8'0"	11'0"	PLAIN
1	2'0"	11'0"	PLAIN
2	3'2"	2'0"	CORNER
1	10'0"	NA	SKIMMER
2	10'0"	NA	PLAIN
1	8'0"	NA	RETURN
1	7'0"	NA	PLAIN
1	5'0"	NA	PLAIN
1	3'6"	NA	PLAIN
1	6'X6'	NA	225° REV CORNER
15	-	NA	A-FRAME
1	-	NA	N&B PKG
			S.A.: 679 sq.ft.
			PER: 102'10"
2236CPRC			DATE: 10-11-00

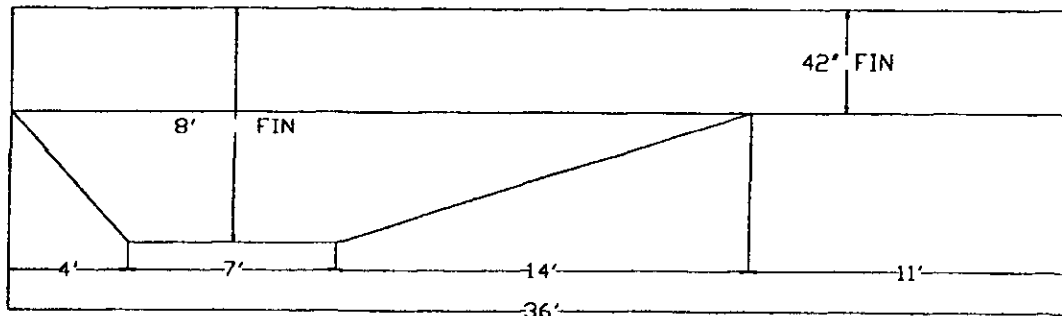

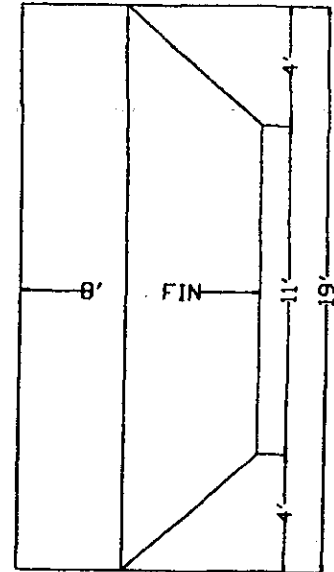
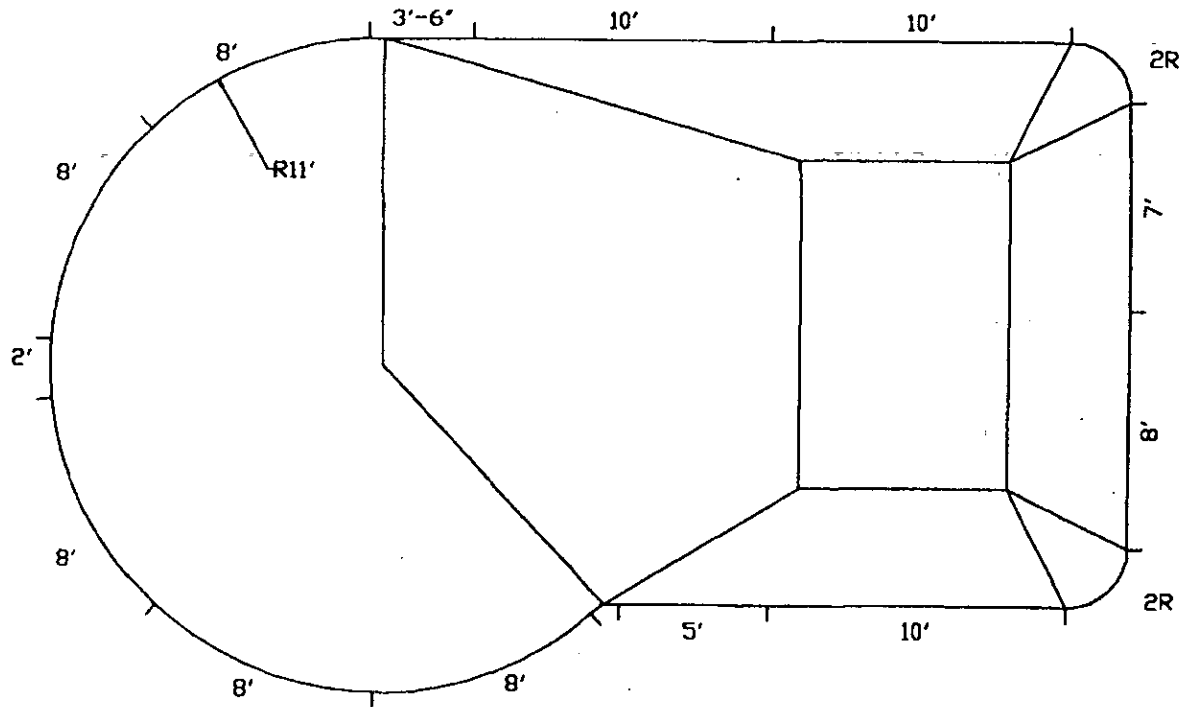

24 BAKER ST. P.O. BOX 100, HASTINGS ON KOL - 1Y0  
 705-696-2385, 1-800-465-3433, FAX: 705-696-1922

**22'X36' L.H. CAPRI**

QTY.	LENGTH	RADIUS	TYPE
1	8'0"	11'0"	RETURN
4	8'0"	11'0"	PLAIN
1	2'0"	11'0"	PLAIN
2	3'2"	2'0"	CORNER
1	10'0"	NA	SKIMMER
2	10'0"	NA	PLAIN
1	8'0"	NA	RETURN
1	7'0"	NA	PLAIN
1	5'0"	NA	PLAIN
1	3'6"	NA	PLAIN
1	6'X6'	NA	225° REV CORNER
15	-	NA	A-FRAME
1	-	NA	N&B PKG
			S.A. 679 sq.ft.
			PER: 102'10"
2236CPRC			DATE: 10-11-00

