



**Phaethon**  
CAVING LIGHT



**Owner's Operating Manual for**

# **Phaethon**

*You should read this manual from beginning to end to ensure normal operation of the device and proper maintenance.*

# Contents

About Phaethon .....	03
Features.....	03
Phaethon Anatomy.....	04
Normal Operation.....	04
On / Off Modes.....	04
Strobe Modes .....	05
Levels and Run-times.....	06
Battery Case.....	07
Voltage Notifications.....	07
Overheating Protection.....	07
Mounting Options.....	08
Driver Set up.....	09
Upgrading the LEDs.....	09
Replacement of the batteries.....	10
Maintenance.....	10
Charging the batteries.....	11
Information about Li-ion Batteries.....	12
Helpful Hints.....	12
Warnings.....	12
Warranty.....	12
Warranty Details.....	13
Warranty Commitments.....	13
Warranty NULL AND VOID if:.....	13
Technical Specifications.....	14
Contact info.....	14

# About Phaethon

The Phaethon is a new exclusive high end caving light system, designed and constructed by Greek cavers to conform with all caving needs including cave-diving and Photography. In addition, the lamp could be used for several more outdoor activities like biking, trekking and mountaineering.



The design started from scratch with an emphasis on durability, simplicity and style, wishing to combine compact dimensions and low cost without compromising the quality and reliability of the final product.

In the development of this project we have been helped by the comments and contributions of many caving and cave-diving colleagues and friends, who we would like to thank. Your own comments and feedback will help us to make future versions of the Phaethon even better.

## Features

- LEDs operate constantly together
- Up to 5 modes
- 6 strobe modes



# Phaethon Anatomy

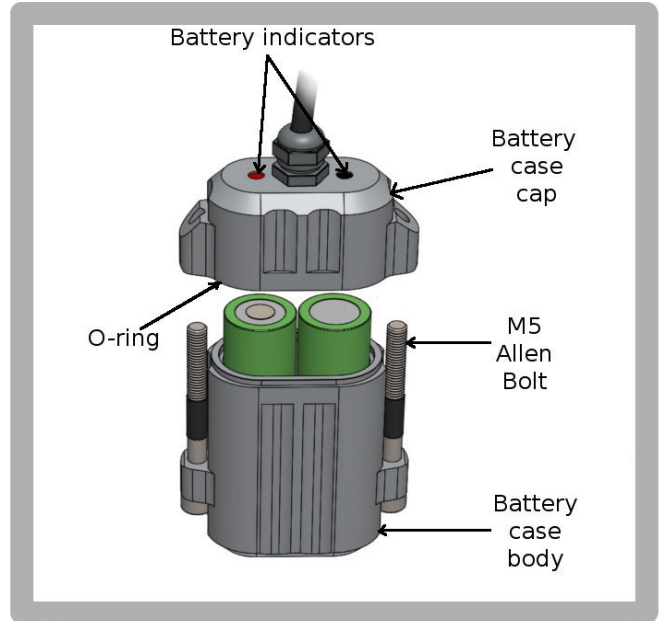

## Normal Operation

The Phaethon use a piezoelectric switch which requires 3 Newtons of pressure to operate - it is not touch sensitive.

The lamp have electronic lock-off to prevent accidental or unintended use.

### **Definitions**

*CLICK* – a short press of less than 0.3 seconds and release.

*PRESS* – a longer press of more than 0.3 seconds and hold.

## On/Off Modes

The Phaethon has been set up with 5 modes. To turn on the light, the user clicks three times, no more than 0.3 seconds apart. The lamp will turn ON at the previous mode it was on. Every subsequent click will increase mode until the brightest mode is reached. To drop down to the previous levels the user has to press and release the button when the desired mode is reached. If the lowest (dimmiest) mode is reached and the user continues to press, the led will blink once to indicate that this is the lowest mode. If the user keeps pressing the switch, the lamp will turn off after a short safety delay.

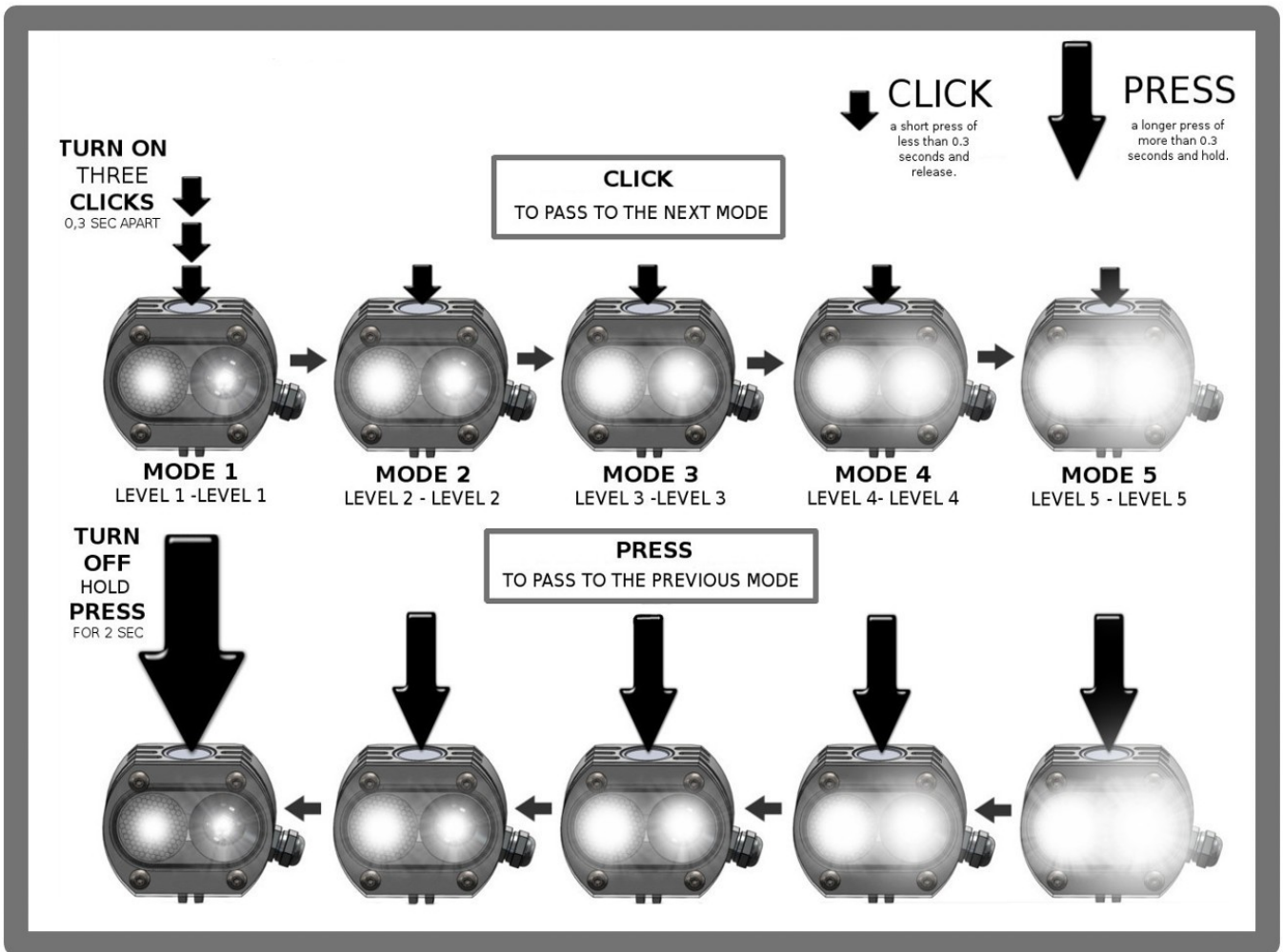

## Strobe Modes

The Phaethon has six different strobe sequences for bicycle use or emergency signaling. To operate the light in strobe mode, the user clicks twice and presses, no more than 0.3 seconds apart until the lamp starts to flash. Subsequent clicks will cycle to the next strobe sequence (until the 6th is reached) and then back to the first sequence. From there on, a press will turn off the light after a “safety delay” of about two seconds.

**The user can program the 6 strobe sequences according to his preference. See customization chapter.**

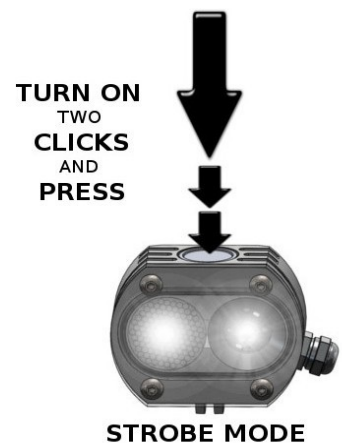

# Levels and Run-times

There are two main factors that determine battery run-times: The current drawn by the LEDs and the battery capacity remaining.

The lamp have five levels of brightness. The brightness scales of those levels are determined by the setting of the maximum current drive we have set. The default value is 3A, which is the maximum we should use, and this sets the current consumption for the other four levels.

LEVEL 1	LEVEL 2	LEVEL 3	LEVEL 4	LEVEL 5
40 mA	260 mA	500 mA	1300 mA	3000 mA

Choosing the right levels for every situation the user can balance economy versus the right light output.

We recommend and use as standard two Panasonic NCR-B 3400mAh which give really good run-times.

PHAETHON	Wide LED	Spot LED	LUMENS	Run-times
MODE 1	Level 1 40mAh	Level 1 40mAh	50	4800 min
MODE 2	Level 2 260mAh	Level 2 260mAh	300	740 min
MODE 3	Level 3 500mAh	Level 3 500mAh	600	385 min
MODE 4	Level 4 1300mAh	Level 4 1300mAh	1200	165 min
MODE 5	Level 5 3000mAh	Level 5 3000mAh	2000	30 min

- Using the default LEDs (XML-2 U2 3C) set up at 3A max with Panasonic 3400mAh batteries.
- The lumen scores mentioned above have been calculated on the basis of the manufacturer data-sheet for the current levels (in mA) observed at each level.
- The durations quoted have been measured at each level in controlled laboratory conditions.
- After running for 30 minutes at Level 5 (2000 lumens) the batteries would still last for hours at lower levels. (L1,L2,L3)

## Battery Case

To save bulk and weight, the Phaethon runs off two rather than four batteries. It still gives pretty good run-times, so we feel justified in this decision. Better to have the lamp weighting less on the helmet and carry spare batteries in a pocket.

The battery pack has been designed to take off-the-shelf (unprotected) 18650 Li-Ion batteries so that the user can choose whatever brand he or she prefers.

Protected 18650 batteries longer than 68mm may not fit inside the case.

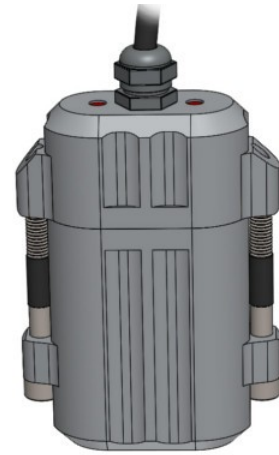

## Voltage Notifications

The Phaethon's driver monitors the voltage of the batteries. Three status notifications are signaled to the user through blinking the LEDs.

- **MEDIUM:** When the batteries reach half power, the lamp will blink once every 30 seconds, five times.
- **LOW:** When the batteries reach the final 10% of their power, the lamp will blink twice every 30 seconds and will continue to do so until we reach the third warning.
- **CUT-OFF:** At the third warning (three blinks every 30 seconds), the batteries ought to be changed and charged. The lamp may continue to be used in case of emergency, but this is not recommended as the battery level will drop to a very low level and there is a possibility to damage the cells.

*At the fifth level the voltage drop is very high and that makes the lamp show the medium notification too early. The voltage status notifications are most accurate and should be taken into account when the lamp is operated on second level.*

## Overheating Protection

It is recommended that the lamp is not operated at the highest levels continuously outside water.

If the lamp is operated at high level outside water, there is a danger of overheating in a few minutes. However the internal driver monitors the temperature and will prevent overheating by dropping the current draw to 1/3 of that level until the lamp has returned to a safe operating temperature. We may help cool the lamp by using water to speed the process (immersing the light in cold water).



# Mounting Options

By using the Go-Pro standard mount we allow a large range of mounting accessories to be used, according to your needs and preferences.

We just have to unscrew the bolt that connects the lamp with the mount and place it in whatever mount option we want to use.

**Headband:** All the lamps come with the standard elastic headband mount. With this we can wear the lamp directly on the head or mount it on a helmet if it supports clips to attach the headband.



**Helmet:** The user can be supplied with the go-pro helmet mount to attach the head of the lamp. For the battery case we have adopted the simple solution of using elastic bungees to hold it. The user has to make two or four holes on the back of the helmet to pass through the cords.

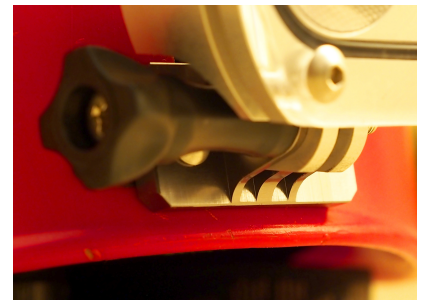

**Handlebar:** To attach it on a bike's handlebar you should first get the go-pro mount adapter and attach it on the riser. After that you could mount the head of the lamp on the riser and the battery case on the top tube or the down tube with an elastic Velcro loop. You should also first cover the battery case with a rubber loop to protect both bike and lamp from scratches and to obtain better stability.

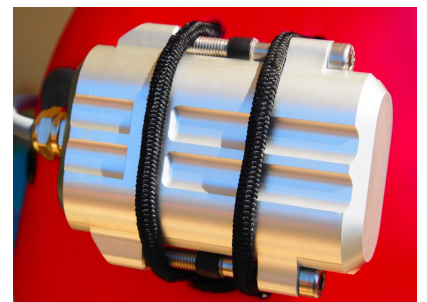

**Goodman handle:** For diving use as a handle torch.





# Driver Set up

Phaethon lamp use a high quality drivers called Lflex sourced from the American leader on driving LEDs solutions, [TASKLED](#). Besides reliability and efficiency, this drivers offer us user customization in the setup, if we'd like to tune it to our needs.

**The driver is already set up by us for optimal performance.**

However if we want to make any changes to the current setup we could do this easily. By plugging in the batteries and keeping the switch pressed down we enter the menu.

Before we do so, we should download the manual of the driver and read it thoroughly. Any changes made to the default settings are done at the user's responsibility. We do not forbid such modifications, but we advise against modifications without good reason because any misunderstanding of the set-up procedure may make a mess of the settings. We suggest to communicate with us for details if you are not sure of the process. Never set the highest ampere rate to 3,5A.

**Phaethon** comes with the [Lflex](#) driver. This Driver has been configured regarding the highest current to be drawn, how many modes we want to use (2 or 3 or 5), what strobe sequence we want, the temperature trigger point, voltage notifications and many more. For any tweak or set up configuration, the user should first read the driver manual thoroughly. Any changes made will be at the responsibility of the user.

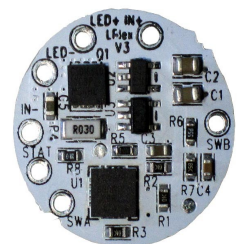

[lFlex.pdf](#) (manual for lFlex UI-UNI4 firmware, V1.00)  
ENGLISH version.

[lFlex.pdf](#) (manual for lFlex UI-UNI4 firmware, V1.00)  
FRENCH version.

# Upgrading the LEDs

Phaethon is fully upgradeable. The LEDs used can be removed and replaced with more advanced LEDs that will come in the near future.

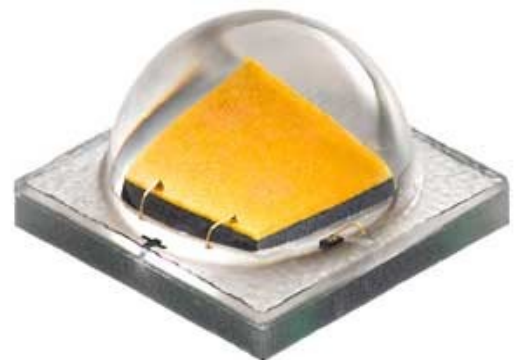

## Replacement of the batteries

*Replacing the batteries in Phaethon is so easy, it can be done in less than a minute.*

**ONLY unprotected 18650 batteries can fit inside the pack.**

Loosen the M5 bolts sealing the battery pack with a hex-key (Allen key), then unscrew them by hand.

Insert new batteries into the casing. It is not important to have specific polarity inside the case. When replacing the cap, match up the positive terminal with the red dot on the casing, and the negative with the black dot. The caving light will flash to indicate that the polarity is correct.

Screw in the bolts by hand and tighten them with the hex-key (Allen key). If the casing is screwed in with wrong polarity, the lamp will not light, but no damage to the lamp's circuit will be done.

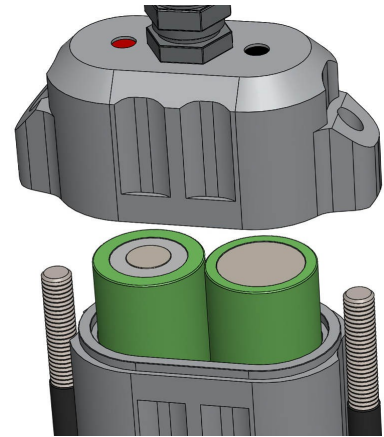

*It is not absolutely necessary to tighten the bolts with a hex-key if you are not going to dive. If they are tightened firmly by hand only, the battery case is still waterproof.*

## Maintenance

- The user has to check the two o-rings before each use and that the condition of the plexiglass cover (cracks). We recommend replacing the o-rings every 2 years unless there are visible signs of wear sooner.
- To change the Plexiglas you should unscrew the four allen M4 bolts from the front side of the head, replace the glass and screw the bolts back in until you see that the black line of the o-ring is uninterrupted. Do not tighten the bolts too much.
- After each use, we recommend that you clean the lamp with fresh water and allow it to dry away from the sun. Do not forget it inside your dirty and moisty caving sack.
- Store it in a dry place.
- The contacts on the battery case should be always clean and without any deteriorations.

# Charging the Batteries

**We have available two Nitecore models. The i2 and the UM20 chargers.**

The [Nitecore i2](#) is able to automatically identify Li-ion, Ni-MH and Ni-Cd rechargeable batteries and apply an appropriate charging mode (Constant Charge Current (CC), Constant Charge Voltage (CV) and Trickle Charge).

Each of the i2's two microcomputer-controlled charging slots is capable of monitoring and charging batteries independently. Additionally, yellow and blue power/charging status indicator lights visibly indicate battery status and charging process.

Just by placing the batteries on the charger it will automatically detect what kind of battery it is and charge it with the right program. It has three LEDs to show the level of voltage. When charging is complete it will stop and light all the LEDs.

It charges with 500mAh which means that for almost empty batteries it needs around 7 hours for a full charge.



**Download [Nitecore i2 user manual](#)**

The [Nitecore UM20](#) is a multi-functional charger with portable and lightweight design is suitable for many rechargeable lithium batteries such as 18650 / 14500 / 10440 / 17670 / 16340 lithium battery.

- Micro USB powered li-ion battery charger.
- High definition LCD displays real time charging status.
- Features micro USB output charging.
- Integrated intelligent power management system.
- Intelligently detects input power and distributes charging power.
- Priority Mode offers either battery or USB charging.
- Features optimized charging program for IMR batteries.
- Intelligently selects charging current based on battery capacity.
- Features rear USB cable winder.
- Constructed from fire retardant materials.
- Features reverse polarity protection.
- Designed for optimal heat dissipation.



**Download [Nitecore UM20 user manual](#)**

Never leave the charger in use when it is unattended.  
Never charge the batteries close to flammable materials.

## Information about Li-ion Batteries

- Store your batteries at room temperature.
- Avoid discharging the batteries fully, prefer partial discharges.
- For extended storage, discharge a lithium-ion battery to about 40 percent and store it in a cool place.
- Avoid using lithium-ion batteries which are hot after a full charge.
- Never leave your lithium battery at an high temperatures like inside a car on sunny day.
- Never overcharge your lithium battery.
- Avoid frequent full discharges of your lithium batteries.
- Lithium-ion batteries should not be exposed to strong impacts or damage - otherwise they can explode!
- No humidity on batteries!
- Always recycle old batteries. Do not throw them into domestic garbage.

## Helpful Hints

- Always charge your batteries before use.
- Use the second level (500mAh) as the main level for caving for good runtimes, good temperature and good light.
- Don't forget the lamp on the highest level when you are out of water as there is a risk of overheating or battery drain.
- Always check thoroughly the condition of both o-rings before diving.

## Warnings

- Always have a spare light source in situations where the two independent light sources rule applies.
- Avoid looking directly at the light for too long or pointing the light at others on high power.
- Make sure children do not use the lamp unsupervised.

## Warranty

We guarantee that the Phaethon lamp you have purchased has been constructed by hand to the highest standards and individually tested as to its waterproofing. If there should be any defect in the materials or manufacturing of your lamp, we will replace or repair the faulty part and return the lamp in fully working order.

## Warranty Details

Phaethon Caving Light provides free repair and a Limited Lifetime Warranty service for our products.

1. Unauthorized third party repairs and modifications to any Phaethon Caving Light product voids Phaethon Caving Light repair service and limited lifetime warranty.
2. The customer is responsible for all freight costs to and from the Authorized repair center.
3. Phaethon Caving Light warranties do not cover commercial use.

## Warranty Commitments

1. 12 months free repair: Phaethon offers a free repair service within 12 months of purchase if a product fails or becomes defective through the course of its intended use. Customers need only to return their product to the repair center.
2. Limited Lifetime Warranty: After 12 months, should the product fail, Phaethon provides a Limited lifetime Warranty for free labor on repairs, should a Phaethon product cease to function through normal use. Under the Limited Lifetime Warranty the customer is responsible for the cost of freight to and from the repair center and the cost of any replacement parts should they be required.
3. Accidental damage: If a product fails as a result of excessive usage (I.E. repeated impacts as a consequence of heavy use) or accidental damage, Phaethon, at its discretion, will provide free labor on repair, charging the customer for the cost of replacement materials only. Customers are responsible for all shipping/postage costs associated with repairs of this nature.
4. We will replace malfunctioning products for an upgraded product in the same series or similar performance for customers if replacement can't be made within due time, when certain products are discontinued, or some other reasons.

## Warranty NULL AND VOID if:

1. Failure or damage caused by excessive dropping or bumping, unauthorized dismantling, oxidation, modification or reconstruction.
2. Failure or damage is caused by improper use, storage or maintenance (refer to product instruction manual).
3. Damage is caused by an unapproved battery or battery leakage.
4. Damage is caused by light flooding, water ingress and corrosion due to water ingress.

# Technical Specifications

## Phaethon's Specs

Two Cree XML-2 U2 3C 4750-5000 K CRI 75  
18 degree optic  
Lflex Taskled linear dimming driver  
5 brightness levels (modes)  
6 customizable strobe modes  
Up to 2000 Lumens output  
Schurter Piezoelectric switch  
Overheating Protection  
Voltage Notification  
Electronic Lock to prevent accidental use  
Anodized Aluminum Alloy 6082  
CNC machined  
Two Panasonic 18650 NCR-B 3400mAh Li-ion Batteries  
GoPro Mount adapter  
Diving Depth -250m  
Individually tested at 10 bars  
Polyurethane extra tough cable  
High quality 4mm Plexiglass  
Limited Lifetime Warranty  
Weight 395 gr (batteries included)

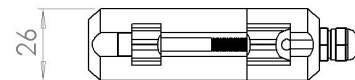
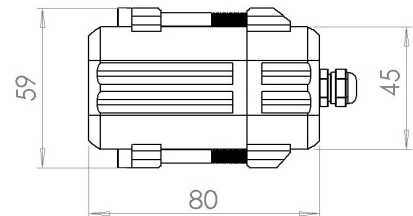
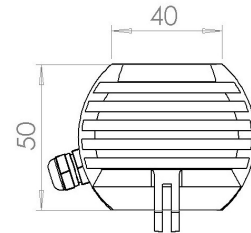
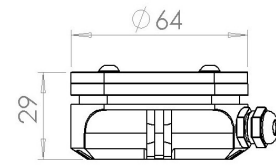

## Contact info

### Phaethon Caving Light

Address: Komninos Boutaras  
20 Patission & Veranzerou  
106 77 Athens  
Greece

Tel./Fax: +30 210 33.00.138

Email: [sales@phaethoncavinglight.com](mailto:sales@phaethoncavinglight.com)  
Webpage : [www.phaethoncavinglight.com](http://www.phaethoncavinglight.com)

