



## ***YOUR MEDICAL HARDWARE SPECIALISTS***



- RENTALS
- REPAIRS
- SERVICE
- SALES
- GAS SHUTDOWNS

**24 HOUR SERVICE**



### **PLEASE CONTACT US AT:**

EMAIL: ValueMed.Sales@Gmail.com  
WEBSITE: [www.valuemed.co](http://www.valuemed.co)  
TOLL FREE: 888-998-VMED (8633)  
FAX: 888-676-0711

# EQUIPMENT REPAIR SERVICES

**\*\*CALL US TODAY FOR EQUIPMENT REPAIR PICK-UP\*\***

## Medical Gas Regulators & Flowmeters



Oxygen  
Medical Air  
Heli-Ox



Carbon Dioxide  
Nitrogen  
Nitrous Oxide

## Suction Regulators



Repair or Upgrade Your  
Overflow Safety Trap

**\$39.50**

**Call For  
Estimates**



\* Chemetron \* Ohmeda \* \* Precision Medical \* Boehringer \*

## Air/Oxygen Blenders

Overhauls  
Water Traps  
Hoses  
Brackets



Bird - Bio Med Devices - Precision Medical  
*Recommended Overhall every 2 years*

## FULL LINE OF CUSTOM HOSES

### AVAILABLE

\*High Pressure Hoses \*Hose  
Assemblies\*Surgey\*

**\*Anesthesia\*Respiratory\***

Thank You Kevin McDermott  
(708)369-3675

**KMCDMED@AOL.COM**



## Oxygen Analyzers & Monitors Replacement Sensors



MiniOx \* Hudson \*Maxtec

## Ventilator Support Arms



## Horizon Gas Block Sales and Service



## Laryngoscope Blades & Handles

\* Replacement\*  
Lamps



## Cufflators



Manometers

## Respirometers



Wright -Boehringer-Haloscale

## Percussors



General Physiotherapy  
Meds Systems



**YOUR MEDICAL HARDWARE SPECIALISTS**

**708-369-3675 - 24 HOUR SERVICE**

**888-998-VMED (8633)**

## RESPIRATORY EQUIPMENT

**\* RENTALS \* REPAIRS \* SERVICE \* SHUTDOWNS \***



**VENTILATORS**

\*SERVO I



\*840



**NON-INVASIVE VENTILATORS**

V60 BIPAP



BIPAP VISION

## SHUTDOWN SERVICES

### VAPOTHERM

PRECISION  
FLOW WITH  
IV STAND



*LET US HELP WITH YOUR EMERGENCY AND PLANNED SHUTDOWNS*

**COMPRESSORS AND  
SUCTION PUMPS**



**CYLINDER CARTS**



*DUAL & SINGLE  
CARTS AVAILABLE*

**REGULATORS**



### COUGH ASSIST



### SHUTDOWN EQUIPMENT

- \* REGULATORS/ PIGTAILS
- \* CYLINDER CARTS
- \* HOSES
- \* AIR COMPRESSORS
- \* SUCTION PUMPS
- STAND & TABLE TOP

# NOTES:

---

---

---

---

---

---

---



**Kevin McDermott**  
(708) 369-3675  
EMAIL: KMCDMED@aol.com  
FAX: 888-676-0711

## alueMed

## INDEX

Air Oxygen Blenders.....	21	High Pressure Hoses.....	42-43
Adapters / Couplers & O2 Regulators:		Insufflator / Pigtails.....	56
Chemetron.....	7	Laryngoscopes.....	26-27
Puritan Bennett.....	9	NIF Gauges.....	18
Ohio.....	11	Nitrogen Accessories.....	53
Medstar.....	13	NPT Fittings.....	40
Diss.....	15	Outlet Accessories.....	46, 54
Ball Valves / Check Valves.....	47	Oxygen Sensors / Fuel Cells.....	24-25
Bulb/Lamp, Replacements.....	28	Oxygen Analyzers / Monitors.....	25
Cufflators.....	19	Patient Lifts / Tolloos.....	58-59
Cylinder Carts / Stands.....	49	Percussors.....	19
Cables / Finger Probes.....	57	Pressure & Vacuum Gauges.....	55
Diss Body Adapters.....	38-39	Rail Systems.....	41
Fisher & Paykel.....	23	Respiratory Accessories.....	20, 22, 29
Flowmeters:		Rolling Stands.....	48
Chemetron.....	6	Rental / Repair.....	2-3
Puritan Bennett.....	8		
Ohio.....	10		
Medstar.....	12		
Specialty.....	16-17		
Diss.....	14		
Gas Testing.....	62		



**Regulators:**

Carbon Dioxide.....50  
 Oxygen.....7, 9, 11, 13, 15, 51  
 Medical Air.....51  
 Nitrous Oxide.....51  
 Heli-Ox.....51  
 Nitrogen.....52

Spirometers.....19

Suction Accessories.....37

Suction Canisters.....34-35

Suction Pumps.....36

**Suction Regulators:**

Boehringer.....30  
 Chemetron / Gentec.....31  
 Precision Medical.....32  
 Beacon Medaes.....32  
 Ohio / Ohmeda.....33  
 Amvex.....33

Tubing & Tubing Nipples.....40

**Wall Outlets:**

Puritan Bennett /  
 Beacon Medaes.....44  
 Chemetron.....45  
 Medstar.....45  
 Ohio.....46

**ABOUT VALUEMED**

Welcome to Valuedmed,

Valuedmed business encompasses hospital sales, biomedical services, onsite medical gas verification, hospital rental equipment, as well as being the largest medical gas and vacuum shutdown supplier in the midwest.

Valuedmed’s sales and technical specialists are available to respond to the unique situations involving the ever changing needs of hospitals.

***Valuedmed Professional Services***

- \*Custom High Pressure Hose Assemblies.....42,43
- \*Onsite & Depot Level Biomedical Services.....61
- \*Onsite Medical Gas Analysis.....62
- \*Outlet Verification.....62
- \*Equipment Repair.....60
- \*Equipment Rental.....63
- \*Shutdown Services.....61





Thank You For Allowing Us to Be Your *VALUED* Partner In Healthcare

**CHEMETRON FLOWMETERS**

	<b>15 LPM Flowmeter With Chemetron Quick Connect</b>	
	Oxygen Flowmeter	15-401
	Air Flowmeter	15-411

	<b>15 LPM Flowmeter With Power Take Off &amp; Chemetron Quick Connect</b>	
	Oxygen Flowmeter	15-401PT
	Air Flowmeter	15-411PT

	<b>0-3 LPM Flowmeter With Chemetron Quick Connect</b>	
	Increments: 1/8 to 1 LPM                      1 to 3 PM	
	Oxygen Flowmeter	3-401

	<b>0-1 LPM Flowmeter With Chemetron Quick Connect</b>	
	Increments: 1/10 to 1 LPM	
	Oxygen Flowmeter	1-401

	<b>200 cc Flowmeter With Chemetron Quick Connect</b>	
	Increments: 25 cc LPM	
	Oxygen Flowmeter	200-401

**CALL US FOR ALL OF YOUR CHEMETRON NEEDS**

**WYE ASSEMBLY**



OXYGEN	22-15-401
OXYGEN with PTO	22-15-401PT
AIR	22-15-411
AIR with PTO	22-15-411PT

**POWER TAKE OFFS**



OXYGEN	P-24
AIR	P-16

**TUBING NIPPLE**



GREEN	132EMG	100/PK
YELLOW	0137	50/PK

**FLOW SELECTOR**



**PM1000**

**FLOWMETER SECURITY CABLE**



**15-167**

**CHEMETRON ADAPTERS & COUPLERS**

	WYE ASSEMBLY		
	PART #	GAS	PRICE
	22-401-400	Oxygen	\$144.00
	22-411-410	Air	\$149.00
	22-431-430	Vacuum	\$169.00

**50 PSI PRESET MODEL WITH CHEMETRON FEMALE**



50-870-400	"E" Tank, O2	870 CGA	Yoke
50-540-400	"H" Tank, O2	540 CGA	Nut
50-950-410	"E" Tank, Air	950 CGA	Yoke
50-346-410	"H" Tank, Air	346 CGA	Nut
50-910-420	"E" Tank, N2O	950 CGA	Yoke
50-236-420	"H" Tank, N2O	346 CGA	Nut

	E-REGULATORS	
	PART#	GAS
	15-870	15 LPM Oxygen
	25-870PT	25 LPM Oxygen W/PTO

**CHEMETRON DISS QUICK CONNECT ADAPTERS**

DISS		
		
PART #	GAS	PRICE
401-55	O2	\$29.00
411-55	AIR	\$29.50
421-55	N2O	\$46.00
431-55	VAC	\$36.00
451-55	EVAC	\$89.00
481-55	CO2	

1/8" NPT MALE		
		
PART #	GAS	PRICE
401-18	O2	\$24.50
411-18	AIR	\$28.50
421-18	N2O	\$39.50
431-18	VAC	\$32.50
451-18	EVAC	\$89.00
481-18	CO2	

1/4" HOSE BARB		
		
PART #	GAS	PRICE
401-77	O2	\$29.00
411-77	AIR	\$29.00
421-77	N2O	\$46.00
431-77	VAC	\$36.00
451-77	EVAC	\$89.00
481-77	CO2	

**CHEMETRON FEMALE COUPLERS**

1/4" HOSE BARB		
		
CHEMETRON / NCG		
400-77	OXYGEN	\$69.00
410-77	AIR	\$69.00
430-77	VACUUM	\$79.00
420-77	N2O	\$89.00
450-77	WAGD	\$149.00
480-77	CO2	\$149.00

DISS MALE		
		
CHEMETRON / NCG		
400-55	OXYGEN	\$69.00
410-55	AIR	\$69.00
430-55	VACUUM	\$79.00
420-55	N2O	\$89.00
450-55	WAGD	\$149.00
480-55	CO2	\$149.00

DISS FEMALE		
		
CHEMETRON / NCG		
55-400	OXYGEN	\$69.00
55-410	AIR	\$69.00
55-430	VACUUM	\$79.00
55-420	N2O	\$89.00
55-450	WAGD	\$139.00
55-480	CO2	\$149.00

1/4" NPT MALE		
		
CHEMETRON / NCG		
400-14	OXYGEN	\$65.00
410-14	AIR	\$65.00
430-14	VACUUM	\$79.00
420-14	N2O	\$89.00
450-14	WAGD	\$139.00
480-14	CO2	\$139.00

**PURITAN BENNETT FLOWMETERS**

	<b>15 LPM Flowmeter With PB Quick Connect</b>	
	Oxygen Flowmeter	15-201
	Air Flowmeter	15-211

	<b>15 LPM Flowmeter With Power Take Off &amp; PB Quick Connect</b>	
	Oxygen Flowmeter	15-201PT
	Air Flowmeter	15-211PT

	<b>0-3 LPM Flowmeter With PB Quick Connect</b>	
	<i>Increments:</i> 1/8 to 1 LPM      1 to 3 PM	
	Oxygen Flowmeter	3-201

	<b>0-1 LPM Flowmeter With PB Quick Connect</b>	
	<i>Increments:</i> 1/10 to 1 LPM	
	Oxygen Flowmeter	1-201

	<b>200 cc Flowmeter With PB Quick Connect</b>	
	<i>Increments:</i> 25 cc LPM	
	Oxygen Flowmeter	200-201

**CALL US FOR ALL OF YOUR  
PURITAN BENNETT NEEDS**

**WYE ASSEMBLY**

	
OXYGEN	22-15-201
OXYGEN with PTO	22-15-201PT
AIR	22-15-211
AIR with PTO	22-15-211PT

**POWER TAKE OFFS**

	
OXYGEN	P-24
AIR	P-16

**TUBING NIPPLE**

		
GREEN	132EMG	100/PK
YELLOW	0137	50/PK

**FLOW SELECTOR**

<b>PM1000</b>

**FLOWMETER SECURITY CABLE**



<b>15-167</b>



**PURITAN BENNETT ADAPTERS & COUPLERS**

WYE ASSEMBLY		
		
PART#	GAS	PRICE
22-201-200	Oxygen	\$144.00
22-211-210	Air	\$149.00
22-231-230	Vacuum	\$169.00

E-REGULATORS	
	
PART#	GAS
15-870	15 LPM Oxygen
25-870PT	25 LPM Oxygen W/ PTO

50 PSI PRESET MODEL WITH PB FEMALE			
			
50-870-200	"E" Tank, O2	870 CGA	Yoke
50-540-200	"H" Tank, O2	540 CGA	Nut
50-950-210	"E" Tank, Air	950 CGA	Yoke
50-346-210	"H" Tank, Air	346 CGA	Nut
50-910-220	"E" Tank, N2O	950 CGA	Yoke
50-236-220	"H" Tank, N2O	346 CGA	Nut

**PURITAN BENNETT DISS QUICK CONNECT ADAPTERS**

DISS		
		
PART #	GAS	PRICE
201-55	O2	\$26.00
211-55	AIR	\$29.00
221-55	N2O	\$46.00
231-55	VAC	\$36.00
251-55	EVAC	\$79.00
281-55	CO2	

1/8" NPT MALE		
		
PART #	GAS	PRICE
201-18	O2	\$15.50
211-18	AIR	\$18.50
221-18	N2O	\$39.50
231-18	VAC	\$32.50
251-18	EVAC	\$59.00
281-18	CO2	

1/4" HOSE BARB		
		
PART #	GAS	PRICE
201-77	O2	\$27.00
211-77	AIR	\$32.50
221-77	N2O	\$44.00
231-77	VAC	\$36.00
251-77	EVAC	\$69.00
281-77	CO2	

**PURITAN BENNETT FEMALE COUPLERS**

1/4" HOSE BARB		
		
Puritan Bennett		
200-77	OXYGEN	\$69.00
210-77	AIR	\$69.00
230-77	VACUUM	\$79.00
220-77	N2O	\$89.00
250-77	WAGD	\$139.00
280-77	CO2	\$139.00

DISS MALE		
		
Puritan Bennett		
200-55	OXYGEN	\$74.00
210-55	AIR	\$74.00
230-55	VACUUM	\$84.00
220-55	N2O	\$96.00
250-55	WAGD	\$139.00
280-55	CO2	\$139.00

DISS FEMALE		
		
Puritan Bennett		
55-200	OXYGEN	\$74.00
55-210	AIR	\$74.00
55-230	VACUUM	\$84.00
55-220	N2O	\$96.00
55-250	WAGD	\$139.00
55-280	CO2	\$139.00

1/4" NPT MALE		
		
Puritan Bennett		
200-14	OXYGEN	\$69.00
210-14	AIR	\$69.00
230-14	VACUUM	\$79.00
220-14	N2O	\$89.00
250-14	WAGD	\$139.00
280-14	CO2	\$139.00

**OHIO FLOWMETERS**

	<b>15 LPM Flowmeter With OHIO Quick Connect</b>	
	Oxygen Flowmeter	15-501
	Air Flowmeter	15-510

	<b>15 LPM Flowmeter With Power Take Off &amp; OHIO Quick Connect</b>	
	Oxygen Flowmeter	15-501PT
	Air Flowmeter	15-510PT

	<b>0-3 LPM Flowmeter With OHIO Quick Connect</b>	
	<i>Increments:</i> 1/8 to 1 LPM                      1 to 3 PM	
	Oxygen Flowmeter	3-501

	<b>0-1 LPM Flowmeter With OHIO Quick Connect</b>	
	Increments:    1/10 to 1 LPM	
	Oxygen Flowmeter	1-501

	<b>200 cc Flowmeter With OHIO Quick Connect</b>	
	<i>Increments:</i> 25 cc LPM	
	Oxygen Flowmeter	200-501

**CALL US FOR ALL OF  
YOUR OHIO NEEDS**

**WYE ASSEMBLY**



OXYGEN	22-15-501
OXYGEN with PTO	22-15-501PT
AIR	22-15-510
AIR with PTO	22-15-510PT

**POWER TAKE OFFS**



OXYGEN	P-24
AIR	P-16

**TUBING NIPPLE**



GREEN	132EMG	100/PK
YELLOW	0137	50/PK

**FLOW SELECTOR**



**PM1000**

**FLOWMETER  
SECURITY CABLE**



**15-167**

**OHIO ADAPTERS & COUPLERS**

**WYE ASSEMBLY**



PART#	GAS	PRICE
22-501-500	OXYGEN	\$144.00
22-511-510	AIR	\$149.00
22-531-530	VACUUM	\$169.00

**E-REGULATORS**



PART#	GAS
15-870	15 LPM Oxygen
25-870PT	25 LPM Oxygen W/ PTO

**50 PSI PRESET MODEL WITH OHIO FEMALE**



50-870-500	"E" Tank, O2	870 CGA	Yoke
50-540-500	"H" Tank, O2	540 CGA	Nut
50-950-510	"E" Tank, Air	950 CGA	Yoke
50-346-510	"H" Tank, Air	346 CGA	Nut
50-910-520	"E" Tank, N2O	950 CGA	Yoke
50-236-520	"H" Tank, N2O	346 CGA	Nut

**OHIO QUICK CONNECT ADAPTERS**

**DISS**



PART #	GAS	PRICE
501-55	O2	\$28.50
511-55	AIR	\$29.50
521-55	N2O	\$37.50
531-55	VAC	\$36.50
551-55	EVAC	\$69.00
581-55	CO2	\$89.00

**1/8" NPT MALE**



PART #	GAS	PRICE
501-18	O2	\$27.00
511-18	AIR	\$27.50
521-18	N2O	\$39.00
531-18	VAC	\$31.50
551-18	EVAC	\$69.00
581-18	CO2	\$69.00

**1/4" HOSE BARB**



PART #	GAS	PRICE
501-77	O2	\$29.50
511-77	AIR	\$29.50
521-77	N2O	\$46.00
531-77	VAC	\$36.50
551-77	EVAC	\$69.00
581-77	CO2	\$89.00

**OHIO FEMALE COUPLERS**

**1/4" HOSE BARB**



**OHIO**

500-77	OXYGEN	\$79.00
510-77	AIR	\$89.00
530-77	VACUUM	\$89.00
520-77	N2O	\$96.00
550-77	WAGD	\$139.00
580-77	CO2	\$139.00

**DISS MALE**



**OHIO**

500-55	OXYGEN	\$79.00
510-55	AIR	\$89.00
530-55	VACUUM	\$89.00
520-55	N2O	\$96.00
550-55	WAGD	\$139.00
580-55	CO2	\$139.00

**DISS FEMALE**



**OHIO**

55-500	OXYGEN	\$79.00
55-510	AIR	\$89.00
55-530	VACUUM	\$96.00
55-520	N2O	\$96.00
55-550	WAGD	\$139.00
55-580	CO2	\$139.00

**1/4" NPT MALE**





**OHIO**

500-14	OXYGEN	\$75.00
510-14	AIR	\$85.00
530-14	VACUUM	\$89.00
520-14	N2O	\$96.00
550-14	WAGD	\$139.00
580-14	CO2	\$139.00

**MEDSTAR FLOWMETERS**

	<b>15 LPM Flowmeter With Quick Connect</b>	
	Medstar Oxygen Flowmeter	15-302
	Medstar Air Flowmeter	15-312
Oxequip Oxygen Flowmeter		15-301
Oxequip Air Flowmeter		15-311

	<b>15 LPM Flowmeter With Power Take Off &amp; Quick Connect</b>	
	Medstar Oxygen Flowmeter	15-302PT
	Medstar Air Flowmeter	15-312PT
Oxequip Oxygen Flowmeter		15-301PT
Oxequip Air Flowmeter		15-311PT

	<b>0-3 LPM Flowmeter With Quick Connect</b>	
	<i>Increments:</i> 1/8 to 1 LPM	
	Medstar Oxygen Flowmeter	3-302
Oxequip Oxygen Flowmeter		3-301

	<b>0-1 LPM Flowmeter With Quick Connect</b>	
	<i>Increments:</i> 1/10	
	Medstar Oxygen Flowmeter	1-302
Oxequip Oxygen Flowmeter		1-301

**CALL US FOR ALL OF  
YOUR MEDSTAR NEEDS**

WYE ASSEMBLY	
	
Medstar	OxEquip
MEDSTAR	
OXYGEN	22-15-302
OXYGEN with PTO	22-15-302PT
AIR	22-15-312
AIR with PTO	22-15-312PT
OXEQUIP	
OXYGEN	22-15-301
OXYGEN with PTO	22-15-301PT
AIR	22-15-311
AIR with PTO	22-15-311PT

POWER TAKE OFFS	
	
OXYGEN	P-24
AIR	P-16

FLOWMETER SECURITY CABLE

15-167

	<b>200 cc Flowmeter With Quick Connect</b>	
	<i>Increments:</i> 25 cc LPM	
	Medstar Oxygen Flowmeter	200-302
Oxequip Oxygen Flowmeter		200-301



**MEDSTAR ADAPTERS & COUPLERS**

WYE ASSEMBLY		
		
PART#	GAS	PRICE
22-302-300	OXYGEN	\$144.00
22-312-310	AIR	\$149.00
22-332-330	VACUUM	\$169.00

E-REGULATORS	
	
PART#	GAS
15-870	15 LPM Oxygen
25-870PT	25 LPM Oxygen W/PTO

50 PSI PRESET MODEL WITH MEDSTAR FEMALE			
			
50-870-300	"E" Tank, O2	870 CGA	Yoke
50-540-300	"H" Tank, O2	540 CGA	Nut
50-950-310	"E" Tank, Air	950 CGA	Yoke
50-346-310	"H" Tank, Air	346 CGA	Nut
50-910-320	"E" Tank, N2O	950 CGA	Yoke
50-236-320	"H" Tank, N2O	346 CGA	Nut

**MEDSTAR QUICK CONNECT ADAPTERS**

DISS Medstar		
		
PART #	GAS	PRICE
302-55	O2	\$64.00
312-55	AIR	\$64.00
322-55	N2O	\$68.00
332-55	VAC	\$68.00
354-55	EVAC	\$89.00
355-55	CO2	\$89.00

1/8" NPT Medstar		
		
PART #	GAS	PRICE
302-18	O2	\$49.50
312-18	AIR	\$49.50
322-18	N2O	\$64.00
332-18	VAC	\$55.00
354-18	EVAC	\$89.00
355-18	CO2	\$89.00

DISS Oxequip		
		
PART #	GAS	PRICE
301-55	O2	\$49.00
311-55	AIR	\$49.00
321-55	N2O	\$59.00
331-55	VAC	\$54.00

1/8" NPT Oxequip		
		
PART #	GAS	PRICE
301-18	O2	\$24.00
311-18	AIR	\$26.00
321-18	N2O	\$38.00
331-18	VAC	\$29.00

**MEDSTAR FEMALE COUPLERS**

1/4" HOSE BARB		
		
MEDSTAR		
300-77	OXYGEN	\$79.00
310-77	AIR	\$79.00
330-77	VACUUM	\$89.00
320-77	N2O	\$89.00
353-77	WAGD	\$149.00
	CO2	\$159.00

DISS MALE		
		
MEDSTAR		
300-55	OXYGEN	\$79.00
310-55	AIR	\$79.00
330-55	VACUUM	\$79.00
320-55	N2O	\$139.00
352-55	WAGD	\$149.00

DISS FEMALE		
		
MEDSTAR		
55-300	OXYGEN	\$89.00
55-310	AIR	\$89.00
55-330	VACUUM	\$89.00
55-320	N2O	\$149.00
55-352	WAGD	\$159.00

1/4" NPT MALE		
		
MEDSTAR		
300-14	OXYGEN	\$79.00
310-14	AIR	\$79.00
330-14	VACUUM	\$89.00
320-14	N2O	\$89.00
352-14	WAGD	\$149.00
	CO2	\$159.00

**DISS FLOWMETERS**

	<b>15 LPM Flowmeter With DISS Quick Connect</b>	
	Oxygen Flowmeter	15-102
	Air Flowmeter	15-112

	<b>DISS 15 LPM Flowmeter With Power Take Off &amp; DISS Quick Connect</b>	
	Oxygen Flowmeter	15-102PT
	Air Flowmeter	15-112PT

	<b>0-3 LPM Flowmeter With DISS Quick Connect</b>	
	<i>Increments:</i> 1/8 to 1 LPM      1 to 3 LPM	
	Oxygen Flowmeter	3-102

	<b>0-1 LPM Flowmeter With DISS Quick Connect</b>	
	<i>Increments:</i> 1/10 LPM	
	Oxygen Flowmeter	1-102

	<b>200 cc Flowmeter With DISS Quick Connect</b>	
	<i>Increments:</i> 25 cc LPM	
	Oxygen Flowmeter	200-102

**CALL US FOR ALL OF  
YOUR DISS NEEDS**

**WYE ASSEMBLY**



OXYGEN	22-15-102
OXYGEN with PTO	22-15-102PT
AIR	22-15-112
AIR with PTO	22-15-112PT

**POWER TAKE OFFS**



OXYGEN	P-24
AIR	P-16

**TUBING NIPPLE**



GREEN	132EMG	100/PK
YELLOW	0137	50/PK

**FLOW SELECTOR**



**PM1000**

**FLOWMETER SECURITY CABLE**



**15-167**

**DISS ADAPTERS & REGULATORS**

**REGULATOR WITH 0-15 FLOW-METER AND POWER TAKE OFF**



PART#	GAS
15-870PT	15 LPM Oxygen W/ PTO
15-870	15 LPM Oxygen

**E-REGULATORS**



PART#	GAS
15-870	15 LPM Oxygen
25-870PT	25 Oxygen W/ PTO

**50 PSI Preset Regulator**



50-870-100	"E" Tank, O2	870 CGA	Yoke
50-540-100	"H" Tank, O2	540 CGA	Nut
50-950-110	"E" Tank, Air	950 CGA	Yoke
50-346-110	"H" Tank, Air	346 CGA	Nut
50-910-120	"E" Tank, N2O	950 CGA	Yoke
50-236-120	"H" Tank, N2O	346 CGA	Nut

**WYE ASSEMBLY**



PART#	GAS	PRICE
22-102-100	OXYGEN	\$144.00
22-112-110	AIR	\$149.00
22-132-130	VACUUM	\$169.00

**ADD "CV" TO PART NUMBER FOR CHECK VALVE**

**STANDARD FLOWMETER NO ADAPTER**

Oxygen  
0-15LPM  
1/8" NPT  
Inlet



AIR  
0-15LPM  
1/8" NPT  
Inlet



Oxygen Flowmeter	102-18F
Air Flowmeter	112-18F

**STANDARD FLOWMETERS NO ADAPTER**



0-1 LPM      1-18F  
0-3 LPM      3-18F  
0-200 cc      200-18F

**YOKE TEE**



013-00  
\$7.50 Each

**Wing Nut Nipple 0158**



Nipple W/Chain  
0158C



**SURE SEAL WASHERS**

7-53 Aluminum, Viton Pack of 50

**SAFETY GLASSES AND GOGGLES**



7333 Fog Free Vented



7326 Clear















LCACK110AFC















LCAST110C

**SPECIALTY FLOWMETERS**

<b>MODEL</b>						
	O2 NEB BLOCK 0-15 FLOWMETER 7-8,14-16,24-26	O2 ELIMINATOR 0-15LPM FLOWMETER	O2 SELECT FLOWMETER 0-15 LPM	O2 DIAL FLOWMETER 25,15,8 & 4 LPM	AIR DIAL FLOWMETER 25 & 15 LPM	CO2 0-12LPM
<b>DISS FEMALE</b> 	1MFA6073 7-8LPM 1MFA6153 14-16LPM 1MFA6243 24-26LPM	1MFA7153 15LPM 1MFA7243 24LPM 1MFA7002 FLUSH	3MFA-1003	25-100-D 25 LPM 15-100-D 15LPM 8-100-D 8LPM 4-100-D 4LPM	25-110-D 25 LPM 15-110-D 15LPM 8-110-D 8LPM 4-110-D 4LPM	CO2-180
<b>PURITAN BENNETT</b> 	1MFA6078 7-8LPM 1MFA6158 14-16LPM 1MFA6248 24-26LPM	1MFA7158 15LPM 1MFA7248 24LPM 1MFA7008 FLUSH	3MFA-1008	25-201-D 25 LPM 15-201-D 15LPM 8-201-D 8LPM 4-201-D 4LPM	25-210-D 25 LPM 15-210-D 15LPM 8-210-D 8LPM 4-210-D 4LPM	CO2-280
<b>CHEMETRON</b> 	1MFA6076 7-8LPM 1MFA6156 14-16LPM 1MFA6246 24-26LPM	1MFA7156 15LPM 1MFA7246 24LPM 1MFA7006 FLUSH	3MFA-1006	25-401-D 25 LPM 15-401-D 15LPM 8-401-D 8LPM 4-401-D 4LPM	25-410-D 25 LPM 15-410-D 15LPM 8-410-D 8LPM 4-410-D 4LPM	CO2-480
<b>OXEQUIP</b> 	1MFA6077 7-8LPM 1MFA6157 14-16LPM 1MFA6247 24-26LPM	1MFA7157 15LPM 1MFA7247 24LPM 1MFA7007 FLUSH	3MFA-1007	25-301-D 25 LPM 15-301-D 15LPM 8-301-D 8LPM 4-301-D 4LPM	25-311-D 25 LPM 15-311-D 15LPM 8-311-D 8LPM 4-311-D 4LPM	N/A
<b>MEDSTAR</b> 	1MFA607M 7-8LPM 1MFA615M 14-16LPM 1MFA624M 24-26LPM	1MFA715M 15 LPM 1MFA724M 24LPM 1MFA700M FLUSH	3MFA-100M	25-302-D 25 LPM 15-302-D 15LPM 8-302-D 8LPM 4-302-D 4LPM	25-312-D 25 LPM 15-312-D 15LPM 8-312-D 8LPM 4-312-D 4LPM	CO2-355
<b>OHMEDA</b> 	1MFA6075 7-8LPM 1MFA6155 14-16 LPM 1MFA6245 24-26LPM	1MFA7155 15LPM 1MFA7245 24LPM 1MFA7005 FLUSH	3MFA-1005	25-501-D 25 LPM 15-501-D 15LPM 8-501-D 8LPM 4-501-D 4LPM	25-510-D 25 LPM 15-510-D 15LPM 8-510-D 8LPM 4-510-D 4LPM	CO2-580
<b>1/8" NPT</b>	1MFA6070 7-8LPM 1MFA6150 14-16LPM 1MFA6240 24-26LPM	1MFA7150 15LPM 1MFA7240 24LPM 1MFA7000 FLUSH	3MFA-1001	18-25-22D 25LPM 18-15-22D 15LPM 18-8-22D 8LPM 18-4-22D 4LPM	18-25-23D 25LPM 18-15-23D 15LPM 18-8-23D 8LPM 18-4-23D 4LPM	18-CO2



## SPECIALTY FLOWMETERS

MODEL	 O2 CEILING 15LPM	 O2 NON-FERROUS .5 - 15 LPM	 COLUMN MOUNT- FLOWMETER O2	 N2O 0-12 LPM	 0-75 LPM O2	 0-75 LPM AIR
DISS FEMALE 	TM-100	NF-100	CM-100	N20-120	75-100	75-110
PURITAN BENNETT 	TM-201	NF-201	CM-201	N20-220	75-201	75-210
CHEMETRON 	TM-401	NF-401	CM-401	N20-420	75-401	75-410
OXEQUIP 	TM-301	NF-301	CM-301	N20-321	75-301	75-311
MEDSTAR 	TM-302	NF-302	CM-302	N20-322	75-302	75-312
OHMEDA 	TM-501	NF-501	CM-501	N20-520	75-501	75-510
1/8" NPT	18-TM	18-NF	18-CM	18-N20	18-75-22	18-75-23

**NIF GAUGES / VACUUM PRESSURE GAUGES**



00-310	\$389.00	Manometer with Adjustable Pop-Off 2.5" to 3.5" Clamp
00-300	\$329.00	Manometer with Adjustable Pop-Off 0.75" to 1.75" Clamp
00-274	\$115.00	Manometer with Adjustable Pop Off
00-199	\$79.00	Replacement Gauge with 0.25" NPT
274-max	\$159.00	Manometer with Pop-Off with MAX Hand
00-273	\$69.00	Pressure Relief Valve
00-195	\$89.00	Wall Mount Bracket for 00-199



**\*\* ALL 2.5" DIAMETER GAUGES\*\***  
**\*\* HEAVY DUTY METAL CASE\*\***



± 30 cm/H2O  
 1/8" Tubing Nipple  
 30-PBS W/O Recorder  
 30-PBR W/Recorder



± 60 cm/H2O  
 1/8" Tubing Nipple  
 60-PBS W/O Recorder  
 60-PBR W/Recorder



-40 +80 cmH2O  
 1/4" NPT Bottom Port  
 60-TBS W/O Recorder  
 60-TBR W/Recorder



± 60 cm/H2O  
 1/4" NPT Back Port  
 60-TRS W/O Recorder  
 60-TRR W/Recorder

**GAUGE ADAPTERS**



BE 148-1

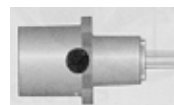

BE 148-6



BE 148-4

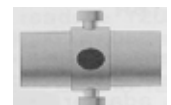

BE 149-1

**GAUGE COVERS**



\$39.00

#00-150  
 Helps Prevent  
 Breakage

**MABIS**

**Sphygmomanometer Replacement Gauges**



05-230-020	BLACK
05-230-010	BLUE

**MANOMETER with POP OFF**



00-274	STANDARD
274-MAX	Max Hand

**GE VERTICAL RAIL BRACKET/GAUGE**



\$329.00	GE1072
----------	--------

**SPIROMETERS / CUFFLATORS / PERCUSSORS**



1 1/2"  
Small Wright Mark 8  
Respirometer 700-008



2"  
Large Wright Mark 21  
Respirometer 700-021



**Rubber Crash Guard**  
700-401 Small Dial Cover  
700-402 Large Dial Face

**CUFF PRESSURE GAUGES**



SENSITIVE  
0-120 CM H2O  
B-54-03-001



STANDARD POSEY  
CUFFLATOR 0-120 CM  
H2O 8199



POCKET CUFF  
0-120 CM H2O  
54-04-000



**MANUJET III KIT**  
Includes 13G, 14G and 16G Jet  
Catheter, Luer Lock Tube  
and 12' hose  
30-01-003



**MEDSYSTEMS - Fluid Flow Percussor**  
2500 DISS Oxygen w/Hose  
2700 DISS Medical Air w/Hose



**G5 NEOCUSSOR Neonatal Percussor Unit**  
Neonatal Percussor NC90  
Replacement Applicators NAP-7PKG 25/Pack

### Precision Endotracheal Tube Anti-Slippage Clamp

\* Modified Precision Cord Clamp \*

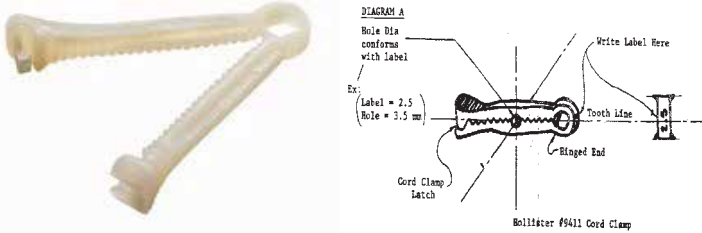

Part ET-20	ET Tube Size 2.0 MM	\$3.99 Each
Part ET-25	ET Tube Size 2.5 MM	\$3.99 Each
Part ET-30	ET Tube Size 3.0 MM	\$3.99 Each
Part ET-35	ET Tube Size 3.5 MM	\$3.99 Each
Part ET-40	ET Tube Size 4.0 MM	\$3.99 Each
Part ET-45	ET Tube Size 4.5 MM	\$3.99 Each
Part M100	Clamp Only	\$1.25 Each

\*CLAMP SOLD SEPARATE FOR MODIFIED CLAMP

### PULSE OXIMETERS

	
Tuffsat Handheld Pulse Oximeter With 36" Finger Clip Sensor & Carrying Case	Fingertip Pulse Oximeter Small and Lightweight Bright LED Display
6050-0006-075	50-104-004
<b>36" Tuffsat Finger Clip Replacement</b>	
<b>Part #</b>	<b>118P46      \$240.000</b>



<b>MAXFLO-2</b>
MF-HIGH FLO \$599
MF-LO FLO \$599



<b>MAX-BLEND W/DISS</b>
MB-HIGH FLO.....\$1599.00
MB-LO FLO.....\$1799.00



<b>MAX-VENTURI WITH SENSOR</b>
MV-S.....\$999.00



<b>SECHRIST</b>
<b>3500 CP-G</b>

**OXYGEN CONCENTRATORS**



<b>INVACARE</b>
10L Platinum 10 W/Sensor <b>IRC-10LX-O2</b>
5L PerfectO2 W/Sensor <b>IRC-5PW</b>

**TIMEMETER AIR COMPRESSOR**



<b>FLOOR MODELS</b>	
E20	Aridyne 2000, 64 LPM
E35	Aridyne 3500, 42 LPM



## AIR OXYGEN BLENDERS



**BIOMED DEVICES**



**TENACORE**



**PRECISION  
MEDICAL**



**BLENDER BUDDY**

Many Options Available  
Call for Details & Pricing

### \*\*BLENDER OVERHAULS\*\*

#### OVERHAULS INCLUDE

- \*Ultrasonic Cleaning
- \*Replacement Of Necessary Parts
- \*Testing \*\*Full PM Kit
- \*Calibration To Manufacturers Specs
- \*Bird
- \*BioMed Devices
- \*Tenacore
- \*Precision
- \*Sechrist

**Overhauls are Recommended Every 2 Years**

#### Blender Accessories

- BM-108-007 10 FT Oxygen Hose, DISS Male x DISS Female
- BM-208-007 10 FT Air Hose, DISS Female x DISS Female
- BM-300-007 Elbowed 0-15 LPM Oxygen Flowmeter
- BM-400-007 Elbowed 0-3 LPM Oxygen Flowmeter
- BM-500-007 Elbowed 0-1 LPM Oxygen Flowmeter
- BM-570-007 Elbowed 0-70 LPM Oxygen Flowmeter
- BM-600-007 Elbowed 15 LPM Oxygen Flowmeter Wye
- AFA11629 Air Inlet Filter/Water Trap
- 1059-007 Stand with Wheels

#### Brackets

- BR-800-007 Pole Mount Bracket
- BR-825-007 Female Dovetail Bracket
- BR-850-007 Wall Mount Bracket
- BR-901-007 Hill Rom / Fairfield Blender Bracket
- BR-903-007 Suction Slide Bracket to Blender
- BR-904-007 Vertical Rail Bracket, GE Incubator

#### POLE MOUNT BRACKET



BR-800-007

#### WATER TRAP



AFA116-2-9

#### STANDARD AIR / OXYGEN BLENDER

#BM-700-01	\$799.00
------------	----------

#### Pediatric Low Flow Air / Oxygen Blender

#BM-700-03	\$839.00
------------	----------

#### MRI Air / Oxygen Blenders

#BM-700-1MRI	\$1,079.00
--------------	------------

#### REFURBISHED BLENDERS AVAILABLE

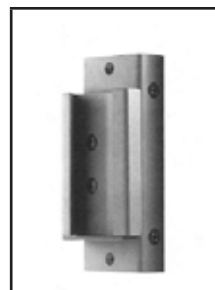

**GE  
VERTICAL  
RAIL BRACKET**

BR-904-007



**ELBOWED  
FLOWMETER**

BM-300-007



**STAND WITH  
WHEELS**

1059



**VAC BRACKET  
TO BLENDER**

BR-903-007





**HILL ROM  
BLENDER  
BRACKET**

BR-901-007



**WALL MOUNT  
BRACKET**

BR-850-007

		2-15 LPM, Diaphragm Style 2" Bourdon Gauges		
		PART #	DESCRIPTION	PRICE
		15-870-DI	"E" Cylinder, 870 CGA Yoke	\$129.00
		15-540-DI	"H" Cylinder, 540 CGA Nut	\$129.00
		*MRI Regulators include 0-15 LPM Flowmeters*		
Oxygen Regulator	MRI Regulator	15MRI-870-DI	Non-Ferrous "E" Regulator, 870 Yoke	\$195.00
		15MRI-540-DI	Non-Ferrous "H" Regulator, 540 Nut	\$195.00

10" ADJUSTABLE WRENCH	
	
10-AW	\$28.00

Thermo Hand Wheel For E Cylinder	
	
6MPR-61	\$23.00

"E" CYLINDER WRENCH & SECURITY CABLE		
		
BMCW-3P	Wrench Only	\$4.90
BMCW-2BC	Wrench & Cable	\$7.85

**COMPRESSOR NEBULIZERS**

	INVACARE	
	Stratos Compact Aerosol Compressor w/ Nebulizer	
	IRC1710	

DRIVE MEDICAL	
	
Pacifica 18060	Power Neb II 18002

Oxygen Flowmeter Tester		
		
Part #	Price	Description
MT-200	\$49.00	1-8L
MT-300	\$49.00	3-15L

**\*\*RESPIRATORY EQUIPMENT REPAIR\*\***

Medical Gas Regulators & Flowmeters

Air/Oxygen Blenders

Overhauls  
Water Traps  
Hoses  
Brackets

Bird - Bio Med Devices - Precision Medical







MINI-WRIGHT PEAK FLOW METERS		
		
00-173	Standard 0-850 LPM	\$36.00
00-174	Low Flow 0-400 LPM	\$36.00

**FISHER & PAYKEL**

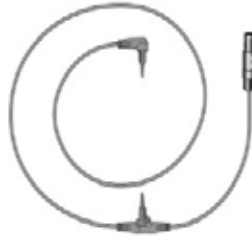
HUMIDIFIER HEATER	
	
MR850	Respiratory Humidifier

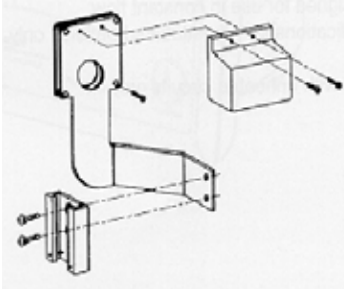
TEMPERATURE PROBES	MR850 RIGHT ANGLE PROBE
	900MR863 for Circuits 28"
	900MR868 for Circuits 44"
	900MR860 for Circuits 52"
	900MR869 for Circuits 60"
	900MR861 for Circuits 72"

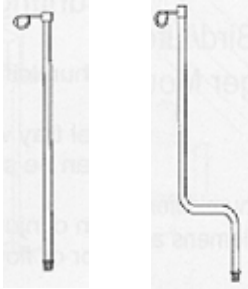
MOUNTING BRACKETS	
	
900MR087	Pole Bracket
900MR088	Draeger, Siemens Bracket
900MR170	"C" Clamp Bracket
900MR304	PB840 Mounting Bracket

WATER BAG POLES	
	
900MR011	Water Bag Pole 50"
900MR012	Water Bag Pole 40"
900MR290	Water Bag Pole, Bent 28"
900MR291	Water Bag Pole, Bent 42"

HUMIDIFICATION CHAMBER	
	
MR290V	Auto-fill Humidification Chamber
MR290VX	Auto-fill Humidification Chamber
MR290HFV	Auto-fill High Frequency Ventilation Adult Chamber
MR250	Adult Chamber
MR225	Neonatal / Pediatric Chamber

VENTILATOR SUPPORT ARM W/ FLEXIBLE TIP		
		
116-56	EACH	\$249.00
116-02	2/CASE	\$399.00
116-56K	REPLACEMENT KNOB	\$19.00

SUPPORT ARM BRACKET		
		
Siemens	BE 114-5	\$89.00
Bird/Draeger	RB 002	\$89.00
Vision	RB 002	\$89.00

EQUIPMENT COVERS		
		
0125 Clear - All Equipment Cover		
48 x 25 x 42		50/Roll

DRAWSTRING BAGS		
		
0059	Standard Bag 11.75" x 15"	500/box
0071	Large Bag 19" x 20" x 5"	250/box



**REPLACEMENT OXYGEN SENSORS / FUEL CELLS**

**MSA/OHIO**  
406931



12 month warranty  
**Replacement For:**  
MiniOx,  
Esprit Ventilator

**MSA/OHIO**  
472062



12 month warranty  
**Replacement For:**  
Siemens 900C, 300  
Avea Ventilator, PB 840

**MAX-13**



**Replacement For:**  
MiniOX I, II, III, 3000  
Teledyne R-17,  
PB 4-020933-00  
Esprit Ventilator  
14 month warranty

**MAX-13-250**



**Replacement For:**  
MiniOx I  
24 month warranty

**MAX-16**



**Replacement For:**  
PB 840 SERIES  
4-072214-00  
16 month warranty

**MAX-12**



**Replacement For:**  
Siemens 900C, 300  
Teledyne R22, R24  
Avea Ventilator  
12 month warranty

**MAX-12A**



**Replacement For:**  
Hillrom Isolette  
Incubator  
Viasys Avea Ventilator  
14 month warranty

**MAX-9**



**Replacement For:**  
Hudson 5500  
12 month warranty

**MAX-1**



**Replacement For:**  
GE/Ohmeda 4760 Oxicap  
5250RGM  
5120 O2 Monitor  
12 month warranty

**MAX-2**



**Replacement For:**  
Draeger anesthesia  
24 month warranty

**MAX-11**



**Replacement For:**  
N.A. Draeger  
Draeger-Narkomed  
Babylog, Evita Ventilator  
12 month warranty

**MAX-12C**



**Replacement For:**  
Viasys, Avea  
Ventilators  
14 month warranty

**MAX-11i**



**Replacement For:**  
Draeger Incubators  
IC 8000  
High Temp Applications  
12 month warranty

**MAX-43**



**Replacement For:**  
GE (Datex Ohmeda)  
Giraffe  
12 month warranty

**FULL LINE OF MAXTEC O2 SENSORS AVAILABLE**

- MAX™-1 (12 month warranty)**  
Replacement for GE (Datex•Ohmeda)\* (common form factor).
- MAX™-2 (24 month warranty)**  
Extra-Life Replacement for Draeger\* Narkomed Series. Large sensor replaces O2 assembly cap and sensor.
- MAX™-8 (24 month warranty)**  
Extra-Life Replacement for GE (Datex•Ohmeda)\*. For external applications only. Large sensor replaces O2 assembly cap and sensor.
- MAX™-9 (14 month warranty)**  
Replacement for Teleflex Medical (Hudson RCI)\* 5500. (CE available upon request).
- MAX™-10 (12 month warranty)**  
Threaded Replacement for GE (Datex•Ohmeda)\* 7900 Smart Vent Series Ventilator.



**OHIO OXYGEN ANALYZERS**

**MAXTEC OXYGEN ANALYZERS**





MiniOX I O2 ANALYZER	
	
473030	\$379.00

MiniOX O2 MONITOR 3000 With HI-LO Alarm	
	
814365	\$603.00

O2 ANALYZER	
	
OM-25AE	\$399.00

O2 MONITOR With HI-LO ALARMS	
	
OM-25ME	\$599.00





**ACCESSORIES**





REPLACEMENT OXYGEN SENSOR		REPLACEMENT SENSOR TEE		REPLACEMENT CABLE		MOUNTING BRACKET				
										
Ohio MiniOx		Maxtec 250E								
OHIO	406931	\$78.00	473021	\$10.50	Ohio	472045	\$59.00	POLE	#474664	\$69.00
MAXTEC	MAX-250E	\$87.00	RP16PO2	\$12.00	Maxtec	R103P16	\$59.00	POLE	R206P75	\$69.00



- MAX™-11 (12 month warranty)**  
Dual Cathode Replacement for Drager\* Narkomed Series (common form factor)  
oxygen analyzer with internal sensor. Babylog
- MAX™-11i (12 month warranty)**  
Dual Cathode Replacement for Drager\* incubators, IC8000. (High temperature applications).
- MAX™-12 (14 month warranty)**  
Replacement for Siemens\* 300 and 900 Series.
- MAX™-12c (14 month warranty)**  
Replacement for Viasys\* [Avea Ventilator, Sipap]
- MAX™-13 (14 month warranty)**  
Replacement for MSA\* MiniOX I, II, III, 3000, PB O2 Monitor.
- MAX™-11i (12 month warranty)**  
Dual Cathode Replacement for Drager\* incubators, IC8000. (High temperature applications).
- MAX™-12 (14 month warranty)**  
Replacement for Siemens\* 300 and 900 Series.
- MAX™-12c (14 month warranty)**  
Replacement for Viasys\* [Avea Ventilator, Sipap]
- MAX™-13 (14 month warranty)**  
Replacement for MSA\* MiniOX I, II, III, 3000, PB O2 Monitor.
- MAX™-13-250 (24 month warranty)**  
Extra-Life Replacement for MSA\* MiniOX I, II, III, 3000, PB O2 Monitor.



- MAX™-14 (14 month warranty)**  
Replacement for MSA\* MiniOX IA.
- MAX™-16 (16 month warranty)**  
Replacement for Covidien/PB\* Ventilators.
- MAX™-16HT (18 month warranty)**  
Replacement for Versamed Vent.
- MAX™-17 (12 month warranty)**  
Replacement for Teledyne\* Monitor 60T, 191T and 2000T.
- MAX™-18 (12 month warranty)**  
Replacement for Teleflex Medical (Hudson RCI)\* 5568.
- MAX™-19 (12 month warranty)**  
Replacement for Teleflex Medical (Hudson RCI)\* 5569.
- MAX™-43 (12 month warranty)**  
Replacement for GE (Datex•Ohmeda)\* Giraffe.
- MAX™-47 (12 month warranty)**  
Replacement for Teleflex Medical (Hudson RCI) 5800 Monitor, 5801 Analyzer.
- MAX™-250+ (24 month warranty)**  
Oxygen replacement sensor for the MAX02
- MAX™-250 (24 month warranty)**  
Oxygen replacement sensor for the OM-25A.
- MAX™-250E (24 month warranty)**  
Oxygen replacement sensor for the MAX02, OM-25ME, OM-25AE, MAXBlend, MaxVenturi and Centry Blender.

**FIBER OPTIC LARYNGOSCOPE BLADES**

MACINTOSH			
PART#	SIZE	PRICE	
5-5231-00	Size 0	\$59.00	
5-5231-01	Size 1	\$59.00	
5-5231-02	Size 2	\$59.00	
5-5231-03	Size 3	\$59.00	
5-5231-35	Size 3.5	\$59.00	
5-5321-04	Size 4	\$59.00	

MILLER			
PART#	SIZE	PRICE	
5-5233-00	Size 0	\$59.00	
5-5233-01	Size 1	\$59.00	
5-5233-02	Size 2	\$59.00	
5-5233-03	Size 3	\$59.00	
5-5233-35	Size 4	\$59.00	

WISCONSIN			
PART#	SIZE	PRICE	
5-5234-02	Size 2	\$59.00	
5-5234-03	Size 3	\$59.00	
5-5234-04	Size 4	\$59.00	

WIS-HIPPLE			
PART#	SIZE	PRICE	
5-5234-20	Size 00	\$59.00	
5-5234-00	Size 0	\$59.00	
5-5234-01	Size 1	\$59.00	
5-5234-15	Size 1.5	\$59.00	

**FIBER-OPTIC HANDLES**



**ALL HANDLES  
\$68.00**

PART#	SIZE	
5-0236-09	Medium Handle	"C"
5-0236-10	Penlite Handle	"AA"
5-0236-11	Stubby Handle	"AA"
5-0236-15	Large Handle	"D"
5-0240-52	FO Lamp 5/pack	2.5 V

**VARIOUS STANDARD AND FIBER OPTIC  
BLADES TO CHOOSE FROM**

*Cranwell	*Phillips	*Robertshaw
*Seward	*Oxford	*Miller/Port
*Heine	*Flangeless Mac	*Siker
*Snow	*Whitehead	*Soper
*Biechman	*Sun Flex	*Prism View

**REPLACEMENT BULBS  
WELCH ALLEN STYLE 5/PACK**



3.5V Laryngoscope  
00300U



3.5V Otoscope  
03100U



2.5V Distal Procto-  
scope Lamp 0600U



3.5V Coaxial Ophthalmoscope  
04900U



2.5V Vacuum Oto-  
scope 0200U



2.5V Otolaryngoscope  
03400U





3.5V Ophthalmos-  
cope Fiber Optic  
03000U





2.5V Ophthalmos-  
cope  
04400U

**STANDARD LARYNGOSCOPE BLADES**

	MACINTOSH		
	PART#	SIZE	PRICE
	5-5052-00	Size 0	\$28.00
	5-5052-01	Size 1	\$28.00
	5-5052-02	Size 2	\$28.00
	5-5052-03	Size 3	\$28.00
	5-5052-04	Size 4	\$28.00

	WISCONSIN		
	PART#	SIZE	PRICE
	5-5057-02	Size 2	\$28.00
	5-5057-03	Size 3	\$28.00
	5-5057-04	Size 4	\$28.00

	MILLER		
	PART#	SIZE	PRICE
	5-5062-20	Size 00	\$28.00
	5-5062-00	Size 0	\$28.00
	5-5062-01	Size 1	\$28.00
	5-5062-15	Size 1.5	\$28.00
	5-5062-02	Size 2	\$28.00
	5-5062-03	Size 3	\$28.00
	5-5062-04	Size 4	\$28.00

	WIS-HIPPLE		
	PART#	SIZE	PRICE
	5-5057-20	Size 00	\$28.00
	5-5057-00	Size 0	\$28.00
	5-5057-01	Size 1	\$28.00
	5-5057-15	Size 1.5	\$28.00

HANDLES			
			
PART#	DESCRIPTION		PRICE
5-0237-01	Penlite Handle	“AA”	\$29.50
5-0237-02	Stubby Handle	“AA”	\$29.50
5-0237-03	Medium Handle	“C”	\$29.50
5-0237-05	Large Handle	“D”	\$29.50

MAGILL FORCEPS			
PART#	DESCRIPTION	PRICE	
9-3018-03	Adult	\$16.50	
9-3018-02	Child	\$16.50	
9-3018-01	Infant	\$16.50	

REPLACEMENT LAMPS - 5/PACK		
*FITS ALL CONVENTIONAL STANDARD BLADES*		
PART#	DESCRIPTION	PRICE
5-0234-01	Standard Frosted, Small	\$17.50
5-0234-04	Standard Frosted, Large	\$17.50
5-0235-01	Standard Clear, Small	\$17.50
5-0235-04	Standard Clear, Large	\$17.50

**SUNBRIGHT REPLACEMENT BULBS**

**\*\*CALL FOR PRICING\*\***

**Welch Allen, Rusch, Propper, Heine Style**

<b>WELCH ALLEN STYLE</b>	
00110	Replaced by #04700
00200	2.5V - Vacuum Otoscope
00300	3.5V - Laryngoscope
00400	Replaced by #04800
00600	2.5V - Distal Proctoscope Lamp
00800	6V - Vaginal Speculum
00900	2.5V - Ophthalmoscope - #121
01000	2.5V - Transilluminator
01100	2.5V - Transilluminator
01300	#40000 - Transilluminator
01800	#177 - Reinoscope
02100	2.5V - Ophthalmoscope - #11500
02200	2.5V - Oscope - #22900
02300	2.5V - Ophthalmoscope - #12900
02500	6V - #46003 - Headlight
02600	6V - #49003 - Headlight
02700	2.5V - Oscope - #24020
03000	3.5V - Ophthalmoscope - #1160
03000	Type 2 (old style) 3.5V - Ophthalmoscope
03100	3.5V - Oscope - Fibre Optic
03300	2.5V - Ophthalmoscope - #11511
03400	2.5V - Oscope - Fibre Optic
03700	3.5V - Retinoscope - #1810
03800	3.5V - Ophthalmoscope - #11810
03900	3.5V - Ophthalmoscope - #11100



<b>WELCH ALLEN STYLE</b>	
04000	6V - Sigmoidoscope
04100	14.25V - Examination Light
04200	12.75V - Examination Light
04300	2.5V - Ophthalmoscope - #11400
04400	2.5V - Ophthalmoscope - Fiber Optic
04500	3.5V - Retinoscope - #18010
04600	2.5V - Retinoscop
04700	2.5V - Laryngoscope Lamp - Small
04800	2.5V - Laryngoscope Lamp - Large
04900	3.5V - Coaxial Ophthalmoscope
06000	2.5V - Fiber Optic Laryngoscope
06000	HPX - Fiber Optic Laryngoscope - 10-32 thread
06100	14.25V - Examination Light
06200	3.5V - Oscope
06300	20 Watt - Examination Light
06400	12V - Halogen Disply Lamp
06500	3.5V - Oscope
07200	2.5V - Retinoscope
07800	6V - Vaginal Speculum - #78103
08100	12V - Examination Light
08200	3.5V - Retinoscope - #18200
08300	3.5V - Spot Retinoscope - #18300
08500	3.5V
08800	4.6V



<b>HEINE LAMPS</b>	
034 - 2.5V	051 - 3.5V
035 - 2.5V	058 - 2.5V
037 - 2.5V	059 - 2.5V
038 - 2.5V	060 - 6V
040 - 2.5V	068 - 2.5V
042 - 2.5V	070 - 3.5V
043 - 2.5V	071 - 2.5V
044 - 3.5V	072 - 3.5V
048 - 3.5V	078 - 3.5V
049 - 3.5V	

<b>RUSCH STYLE LAMPS</b>	
5630	Lamp for FOCS Laryngoscope
8322	Lamp for Lync fiber optic handle and Optima 2 fibre optic handle
8622 300	Frosted Standard Laryngoscope Lamp - Large
8623 100	Frosted Standard Laryngoscope Lamp - Small



<b>PENLON LAMPS</b>	
55091	Laryngoscope - Large
55092	Laryngoscope - Small
55094	Laryngoscope - Fiber Optic





**RESPIRATORY ACCESSORIES**

**TOOTH PROTECTOR**



9-3041-03 Tooth Protector 50/cs

**NOSE CLIPS**



9-0134-44 100/cs

**BACTERIA FILTER/CLEAR**

Bacterial filtration efficiency — 99.8%.  
 Mean particle size 3.1 micron, lab report #18112.  
 22mm Male x 22mm Female, 50/case 64020



**TEST LUNG**

4-0050-50	500-750cc	Medium
4-0050-10	1000cc	Large



**SILICONE CONNECTOR**  
**22mm FEMALE**

#BE-101-00-3443	SOLD EACH
#2200	SOLD IN A CASE OF 50



**VENTILATOR ACCESSORIES PB 840**



**PB 840Ventilator**  
 Disposable Expiratory Bacteria Filter  
 OEM# 4-076887-00  
 12/Case



**PB 840Ventilator**  
 Compressor Inlet Filter  
 OEM# 4-07437-00



**PB 840Ventilator**  
 Reusable Expiratory Bacteria Filter



**7200 Ventilator**  
 Disposable Expiratory Bacteria Filter  
 OEM# G-040526-00  
 12/cs



**840 REPLACEMENT BATTERY**



4-070S23-SP

**PB 840 SCREEN LATCH ASSEMBLY**

4-076671-SP DISPLAY		4073020-00 CART	
------------------------	--	--------------------	---

**BiPAP VISION**

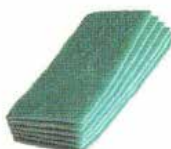
Pollen Filter  
 OEM# 582101  
 6/Pk.

VISION REPLACEMENT BATTERY	1012819
----------------------------	---------

**BiPAP VISION FILTER COVER**



14-2-23	\$96.00
---------	---------

**V60 VENTILATOR**





Filter 5/pk	V60-6F
Battery	1056921

<b>SUCTION REGULATOR OVERFLOW SAFETY TRAP</b>			
DISS Female		Locking Gland	
130-1000	<b>\$63.50</b>	295-1000	<b>\$69.50</b>

<b>OVERFLOW SAFETY TRAP FITTINGS &amp; PARTS</b>		
1. Tubing Nipple	0204-9048-535	
2. Cap	0221-6315-535	
3. O-Ring	0210-0528-300	
4. Splash Deflector	0221-6317-100	
5. Float	0221-6316-100	
6. Jar	0212-0463-100	

**CHEMETRON / GENTEC SUCTION REGULATORS**

		CHEMETRON							
		INLET / OUTLET	DISS FEMALE	BARBED HOSE STEM	OHMEDA	CHEMETRON	OXEQUIP	MEDSTAR	PURITAN BENNETT
	CONTINUOUS/INTERMITTENT	DISS MALE	C-2-130-55	C-2-77-55	C-2-531-55	C-2-431-55	C-2-331-55	C-2-330-55	C-2-231-55
		HOSE BARB	C-2-130-77	C-2-77-77	C-2-531-77	C-2-431-77	C-2-331-77	C-2-330-77	C-2-231-77
	CONTINUOUS	DISS MALE	C-3-130-55	C-3-77-55	C-3-531-55	C-3-431-55	C-3-331-55	C-3-330-55	C-3-231-55
		HOSE BARB	C-3-130-77	C-3-77-77	C-3-531-77	C-3-431-77	C-3-331-77	C-3-330-77	C-3-231-77
<b>CHEMETRON CONT / INT</b>	SURGERY	DISS MALE	C-4-130-55	C-4-77-55	C-4-531-55	C-4-431-55	C-4-331-55	C-4-330-55	C-4-231-55
		HOSE BARB	C-4-130-55	C-4-77-77	C-4-531-77	C-4-431-77	C-4-331-77	C-4-330-77	C-4-231-77
	PEDIATRIC CONTINUOUS/INTERMITTENT	DISS MALE	C-5-130-55	C-5-77-55	C-5-531-55	C-5-431-55	C-5-331-55	C-5-330-55	C-5-231-55
		HOSE BARB	C-5-130-55	C-5-77-77	C-5-531-77	C-5-431-77	C-5-331-77	C-5-330-77	C-5-231-77

		GENTEC							
		INLET / OUTLET	DISS FEMALE	BARBED HOSE STEM	OHMEDA	CHEMETRON	OXEQUIP	MEDSTAR	PURITAN BENNETT
	CONTINUOUS/INTERMITTENT	DISS MALE	G-2-130-55	G-2-77-55	G-2-531-55	G-2-431-55	G-2-331-55	G-2-330-55	G-2-231-55
		HOSE BARB	G-2-130-77	G-2-77-77	G-2-531-77	G-2-431-77	G-2-331-77	G-2-330-77	G-2-231-77
	CONTINUOUS	DISS MALE	G-3-130-55	G-3-77-55	G-3-531-55	G-3-431-55	G-3-331-55	G-3-330-55	G-3-231-55
		HOSE BARB	G-3-130-77	G-3-77-77	G-3-531-77	G-3-431-77	G-3-331-77	G-3-330-77	G-3-231-77
<b>GENTEC CONT / INT</b>	SURGERY	DISS MALE	G-4-130-55	G-4-77-55	G-4-531-55	G-4-431-55	G-4-331-55	G-4-330-55	G-4-231-55
		HOSE BARB	G-4-130-55	G-4-77-77	G-4-531-77	G-4-431-77	G-4-331-77	G-4-330-77	G-4-231-77
	PEDIATRIC CONTINUOUS/INTERMITTENT	DISS MALE	G-5-130-55	G-5-77-55	G-5-531-55	G-5-431-55	G-5-331-55	G-5-330-55	G-5-231-55
		HOSE BARB	G-5-130-55	G-5-77-77	G-5-531-77	G-5-431-77	G-5-331-77	G-5-330-77	G-5-231-77

**\*REMARKETED SUCTION REGULATORS AVAILABLE\***



- \*Chematron
- \*Ohmeda
- \*Precision Medical
- \*Boehringer
- \*Gentec



**CALL FOR ESTIMATES**

**PRECISION MEDICAL / BEACON SUCTION REGULATORS**

MODEL		PRECISION MEDICAL							
		INLET OUTLET	BARBED HOSE STEM	CHEMETRON	DISS FEMALE	OHMEDA	PURITAN BENNETT	OXEQUIP	MEDSTAR
2 MODE CONTINUOUS	DISS MALE	PM3021	PM3016	PM3014	PM3015	PM3019	PM3017	PM3018	
	HOSE BARB	PM3010	PM3005	PM3003	PM3004	PM3008	PM3006	PM3007	
3 MODE CONTINUOUS	DISS MALE	PM3121	PM3116	PM3114	PM3115	PM3119	PM3117	PM3118	
	HOSE BARB	PM3110	PM3105	PM3103	PM3104	PM3108	PM3106	PM3107	
CONTINUOUS INTERMIT- TENT	DISS MALE	PM3321	PM3316	PM3314	PM3315	PM3319	PM3317	PM3318	
	HOSE BARB	PM3310	PM3305	PM3303	PM3304	PM3308	PM3306	PM3307	
PEDIATRIC	DISS MALE	PM3421	PM3416	PM3414	PM3415	PM3419	PM3417	PM3418	
	HOSE BARB	PM3410	PM3405	PM3403	PM3404	PM3408	PM3406	PM3407	

**PRECISION  
MEDICAL  
CONT / INT**

MODEL		PRECISION MEDICAL PRESET							
		INLET OUTLET	BARBED HOSE STEM	CHEMETRON	DISS FEMALE	OHMEDA	PURITAN BENNETT	OXEQUIP	MEDSTAR
2 MODE CONTINUOUS	DISS MALE	PS3021	PS3016	PS3014	PS3015	PS3019	PS3017	PS3018	
	HOSE BARB	PS3010	PS3005	PS3003	PS3004	PS3008	PS3006	PS3007	
3 MODE CONTINUOUS	DISS MALE	PS3121	PS3116	PS3114	PS3115	PS3119	PS3117	PS3118	
	HOSE BARB	PS3110	PS3105	PS3103	PS3104	PS3108	PS3106	PS3107	
CONTINUOUS INTERMIT- TENT	DISS MALE	PS3321	PS3316	PS3314	PS3315	PS3319	PS3317	PS3318	
	HOSE BARB	PS3310	PS3305	PS3303	PS3304	PS3308	PS3306	PS3307	
PEDIATRIC	DISS MALE	PS3421	PS3416	PS3414	PS3415	PS3419	PS3417	PS3418	
	HOSE BARB	PS3410	PS3405	PS3403	PS3404	PS3408	PS3406	PS3407	

**PRESET  
CONT / INT**

MODEL		BEACON MEDAES							
		INLET OUTLET	DISS FEMALE	BARBED HOSE STEM	OHMEDA	CHEMETRON	OXEQUIP	MEDSTAR	PURITAN BENNETT
CONTINUOUS/ INTERMITTENT	DISS MALE	BM-2-130-55	BM-2-77-55	BM-2-531-55	BM-2-431-55	BM-2-331-55	BM-2-330-55	BM-2-231-55	
	HOSE BARB	BM-2-130-77	BM-2-77-77	BM-2-531-77	BM-2-431-77	BM-2-331-77	BM-2-330-77	BM-2-231-77	
CONTINUOUS	DISS MALE	BM-3-130-55	BM-3-77-55	BM-3-531-55	BM-3-431-55	BM-3-331-55	BM-3-330-55	BM-3-231-55	
	HOSE BARB	BM-3-130-77	BM-3-77-77	BM-3-531-77	BM-3-431-77	BM-3-331-77	BM-3-330-77	BM-3-231-77	
SURGERY	DISS MALE	BM-4-130-55	BM-4-77-55	BM-4-531-55	BM-4-431-55	BM-4-331-55	BM-4-330-55	BM-4-231-55	
	HOSE BARB	BM-4-130-55	BM-4-77-77	BM-4-531-77	BM-4-431-77	BM-4-331-77	BM-4-330-77	BM-4-231-77	
PEDIATRIC CON- TINUOUS/ INTERMITTENT	DISS MALE	BM-5-130-55	BM-5-77-55	BM-5-531-55	BM-5-431-55	BM-5-331-55	BM-5-330-55	BM-5-231-55	
	HOSE BARB	BM-5-130-55	BM-5-77-77	BM-5-531-77	BM-5-431-77	BM-5-331-77	BM-5-330-77	BM-5-231-77	

**BEACON  
MEDAES  
CONT / INT**



**OHIO / OHMEDA / AMVEX SUCTION REGULATORS**

		OHIO / OHMEDA							
		INLET OUTLET	DISS FEMALE	BARBED HOSE STEM	OHMEDA	CHEMETRON	OXEQUIP	MEDSTAR	PURITAN BENNETT
CONTINUOUS/ INTERMITTENT	DISS MALE	H-2-130-55	H-2-77-55	H-2-531-55	H-2-431-55	H-2-331-55	H-2-330-55	H-2-231-55	
	HOSE BARB	H-2-130-77	H-2-77-77	H-2-531-77	H-2-431-77	H-2-331-77	H-2-330-77	H-2-231-77	
CONTINUOUS	DISS MALE	H-3-130-55	H-3-77-55	H-3-531-55	H-3-431-55	H-3-331-55	H-3-330-55	H-3-231-55	
	HOSE BARB	H-3-130-77	H-3-77-77	H-3-531-77	H-3-431-77	H-3-331-77	H-3-330-77	H-3-231-77	
SURGERY	DISS MALE	H-4-130-55	H-4-77-55	H-4-531-55	H-4-431-55	H-4-331-55	H-4-330-55	H-4-231-55	
	HOSE BARB	H-4-130-55	H-4-77-77	H-4-531-77	H-4-431-77	H-4-331-77	H-4-330-77	H-4-231-77	
OHIO / OHMEDA CONT / INT	DISS MALE	H-5-130-55	H-5-77-55	H-5-531-55	H-5-431-55	H-5-331-55	H-5-330-55	H-5-231-55	
	HOSE BARB	H-5-130-55	H-5-77-77	H-5-531-77	H-5-431-77	H-5-331-77	H-5-330-77	H-5-231-77	

		OHIO / OHMEDA PUSH TO SET							
		INLET OUTLET	DISS FEMALE	BARBED HOSE STEM	OHMEDA	CHEMETRON	OXEQUIP	MEDSTAR	PURITAN BENNETT
CONTINUOUS/ INTERMITTENT	DISS MALE	HP-2-130-55	HP-2-77-55	HP-2-531-55	HP-2-431-55	HP-2-331-55	HP-2-330-55	HP-2-231-55	
	HOSE BARB	HP-2-130-77	HP-2-77-77	HP-2-531-77	HP-2-431-77	HP-2-331-77	HP-2-330-77	HP-2-231-77	
CONTINUOUS	DISS MALE	HP-3-130-55	HP-3-77-55	HP-3-531-55	HP-3-431-55	HP-3-331-55	HP-3-330-55	HP-3-231-55	
	HOSE BARB	HP-3-130-77	HP-3-77-77	HP-3-531-77	HP-3-431-77	HP-3-331-77	HP-3-330-77	HP-3-231-77	
SURGERY	DISS MALE	HP-4-130-55	HP-4-77-55	HP-4-531-55	HP-4-431-55	HP-4-331-55	HP-4-330-55	HP-4-231-55	
	HOSE BARB	HP-4-130-55	HP-4-77-77	HP-4-531-77	HP-4-431-77	HP-4-331-77	HP-4-330-77	HP-4-231-77	
PUSH TO SET CONT / INT	DISS MALE	HP-5-130-55	HP-5-77-55	HP-5-531-55	HP-5-431-55	HP-5-331-55	HP-5-330-55	HP-5-231-55	
	HOSE BARB	HP-5-130-55	HP-5-77-77	HP-5-531-77	HP-5-431-77	HP-5-331-77	HP-5-330-77	HP-5-231-77	

		AMVEX							
		INLET OUTLET	DISS FEMALE	BARBED HOSE STEM	OHMEDA	CHEMETRON	OXEQUIP	MEDSTAR	PURITAN BENNETT
CONTINUOUS/ INTERMITTENT	DISS MALE	A-2-130-55	A-2-77-55	A-2-531-55	A-2-431-55	A-2-331-55	A-2-330-55	A-2-231-55	
	HOSE BARB	A-2-130-77	A-2-77-77	A-2-531-77	A-2-431-77	A-2-331-77	A-2-330-77	A-2-231-77	
CONTINUOUS	DISS MALE	A-3-130-55	A-3-77-55	A-3-531-55	A-3-431-55	A-3-331-55	A-3-330-55	A-3-231-55	
	HOSE BARB	A-3-130-77	A-3-77-77	A-3-531-77	A-3-431-77	A-3-331-77	A-3-330-77	A-3-231-77	
SURGERY	DISS MALE	A-4-130-55	A-4-77-55	A-4-531-55	A-4-431-55	A-4-331-55	A-4-330-55	A-4-231-55	
	HOSE BARB	A-4-130-55	A-4-77-77	A-4-531-77	A-4-431-77	A-4-331-77	A-4-330-77	A-4-231-77	
AMVEX CONT / INT	DISS MALE	A-5-130-55	A-5-77-55	A-5-531-55	A-5-431-55	A-5-331-55	A-5-330-55	A-5-231-55	
	HOSE BARB	A-5-130-55	A-5-77-77	A-5-531-77	A-5-431-77	A-5-331-77	A-5-330-77	A-5-231-77	

**CANISTERS & ACCESSORIES**

CARDINAL	
	
65651-212	1200cc Stem 40/CS
65651-220	2000cc Stem 40/CS
65651-230	3000cc Stem 40/CS

BEMIS	
	
424410	800cc Stem 100/CS
434410	1200cc Stem 48/CS
435410	2000cc Stem 48/CS

ALLIED	
	
08-0003	1500ML Stem 48/Case
08-0004	1500ML DISS 48/Case
08-0002	2400ML Stem 36/Case
08-0001	2400ML DISS 36/Case

**REUSABLE OUTER CANISTER FOR DISPOSABLE LINERS**

*BUILT IN* ON/OFF VALVE	
	
65652-511	1000cc
65652-516	1500cc
65652-531	3000cc

WALL MOUNT	
	
65652-513	1000cc
65652-518	1500cc
65652-533	3000cc

EXTENDED BRACKET FOR REGULATORS	
	
65652-512	1000cc
65652-517	1500cc
65652-532	3000cc

DIRECT TO REGULATOR	
	
65652-555	1000cc
65652-562	1500cc

**CARDINAL**

Canister Ring Featuring Pre-Attached Tubing & Built-In Internal On/Off Valve  
 Accommodates 1200cc Canister with On/Off Valve **65652-159**  
 Accommodates 2000cc & 3000cc Canister with On/Off Valve **65652-139**  
 Accommodates 1200cc Canister without On/Off Valve **65652-155**  
 Accommodates 2000cc & 3000cc Canister without On/Off Valve **65652-135**



**DISPOSABLE SUCTION TUBING**

Suction Tubing, 6 Ft                    536010    25/Cs  
 Suction Tubing, 1.5 Ft                536510    50/Cs



**SUCTION CANISTER RINGS**

**BEMIS WALL CANISTER RING - METAL**

Accommodates Bemis 800cc Canister	4 3/4"ID	534510
Accommodates Bemis 1200, 2000 & 3000cc Canisters	5 5/8"ID	532810
Accommodates Medi-Vac 1200cc Guardian Canister	4 3/4"ID	534510

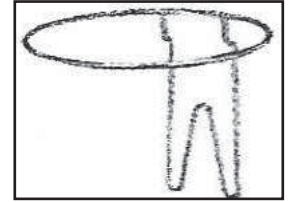

**BEMIS WALL CANISTER RING - PLASTIC**

Accommodates 1200cc, 2000cc & 3000cc Bemis Canister	5 5/8"ID	532710
---	----------	--------

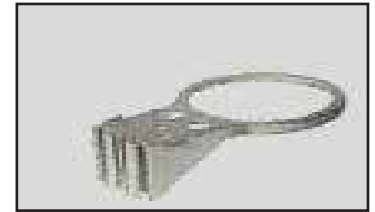

**ALLIED HEALTHCARE CANISTER RING**

Accommodates 1500 & 2400ml Allied Canisters	5 1/4"ID	02-0150
---	----------	---------



**CARDINAL STANDARD CANISTER RING**

-Accommodates Cardinal 1000cc Canister	4 3/8"ID	65652-584
-Accommodates Cardinal 1200cc Canister	4 3/8"ID	65652-584
-Accommodates Cardinal 1500cc Canister	5 1/8"ID	65652-563
-Accommodates Cardinal 3000cc Canister	6 3/4"ID	65652-561
-Accommodates Medi-Vac 1200cc	4 3/8"ID	65652-584
& Guardian / Bemis 800cc Canister	4 3/8"ID	65652-584



**FOUR CANISTER CARRIERS**

**\*\*STANDS COME WITHOUT RINGS\*\***

ALLIED / CHEMETRON		
		
20-02-0023	36" Tall	\$313.00

BEMIS		
		
533910	Adjustable	\$238.00

**SUCTION PUMPS**

**BATTERY OPERATED CRASH CART PUMPS**



MANUFACTURER	PART#	RUN TIME
GOMCO	G-180	1 Hour
PRECISION MEDICAL	PM 65	75 Minutes
OHIO	758000	1 Hour

**TABLE TOP SUCTION PUMPS**



MANUFACTURER	MODEL	PART#
GOMCO	Model 300	01-22-3001
GOMCO	Model 405	01-12-4005

**STAND MODEL SUCTION PUMPS**



MANUFACTURER	MODEL	PART#
GOMCO	3040 Aspirator	01-32-3041
GOMCO	6000 Thermotic	01-32-6002
GOMCO	6037 Combination Unit	01-32-6037
AEROS	Mobilvac III Combination Unit	70-850-01



**\*SUCTION REGULATOR REPAIR\***

\* Chemetron \* Ohmeda \* Precision Medical \* Boehringer \* Gentec\*

ALL MODELS AVAILABLE: (CONTINUOUS-INTERMITTENT-SURGERY)



**With Suction Regulator  
Repair or Upgrade**



**Your Overflow Safety Trap is  
\$39.50**







**SUCTION ACCESSORIES**

<b>CEILING MOUNT 7" LONG ADAPTER</b>



**Adapter Only** 852

	<b>1/8" NPT</b>
	DISS Male, Vacuum
25-132-02	\$17.00
	<b>Tubing Nipple</b>
	Vacuum Regulator
25-999	\$9.50
	<b>Disposable</b>
	Hydrophobic Filter 3/Pack
01-90-3100	\$19.00

	<b>Metal Female DISS x</b>
	Universal Tubing Barb
531410	\$29.00
	<b>Plastic Female DISS</b>
	with 1/8" NPT Adapter
65652-131	\$18.50
	<b>Female DISS x Tubing Barb</b>
531110	\$18.75
	<b>1/8" Male NPT x DISS x</b>
	Universal Tubing Barb
531110	\$27.50
	<b>Main Line Suction Full Demand</b>
	<b>INLET</b>
	<b>PART#</b>
	DISS Female Inlet 40-131
	Ohmeda Inlet 40-531
	Chemetron / NCG Inlet 40-431
	Oxequip Inlet 40-331
	Medstar Inlet 40-332
	Puritan Bennett Inlet 40-231

<b>OVERFLOW FILTER SET-UP</b>

3100-01 Flexi-Filter
3100-44 Flexi-Filter w/Elbow
\$37.50 Each



<b>SUCTION REGULATOR SECURITY CABLE</b>	
	
#OH-167	\$5.35 Each

**BRACKETS**

<b>VERTICAL RAIL BRACKET</b>

\$259.00 EACH
Bed Warmers / OR Stands
OXYGEN #6700-0411-800
MED AIR #6700-0412-800
VACUUM #6700-0410-800

<b>INCLINE VACUUM ON/OFF VALVE</b>	
	Plastic
#45-65652-580	\$18.50
	Metal
1/8" NPT	
#45-7064	\$49.00

<b>WALL MOUNT SUCTION CANISTER HOLDERS</b>			
	Plastic		Aluminum
530510	\$19.50	#22-11-0006	\$49.50

<b>Fairfield / HilRom Rail Mount</b>	<b>Bottle Holder</b>		
			
#40-9788	\$129.00	#22-11-0004	\$39.00

<b>RAIL BLOCK ASSEMBLY</b>	
	
OXYGEN	7223
MED AIR	7224
VACUUM	7225

<b>VACUUM QUICK CONNECT WITH BOTTLE HOLDER</b>		
		
<b>INLET</b>	<b>PART#</b>	<b>PRICE</b>
DISS Female Inlet	40-30-131	\$139.00
Ohmeda Inlet	40-30-531	\$139.00
Chemetron / NCG Inlet	40-30-431	\$139.00
Oxequip Inlet	40-30-331	\$139.00
Medstar Inlet	40-30-332	\$159.00
Puritan Bennett Inlet	40-30-231	\$139.00

**DISS BODY ADAPTERS**

DISS MALE BY NPT MALE		
1/8" PART#	1/4" PART#	GAS
102-18	102-14	OXYGEN
112-18	112-14	AIR
122-18	122-14	NITROUS OXIDE
132-18	132-14	VACUUM
142-18	142-14	NITROGEN
Not Available	152-14	EVAC
Not Available	182-14	CARBON DIOXIDE
Not Available	197-14	HELIUM
162-18	162-14	INSTRUMENT AIR



1/8" NPT MALE

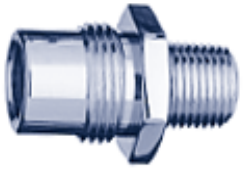

1/4" NPT MALE

DISS MALE BY NPT MALE WITH CHECK VALVE		
1/8" PART#	1/4" PART#	GAS
102-CV-18	102-CV-14	OXYGEN
112-CV-18	112-CV-14	AIR
122-CV-18	122-CV-14	NITROUS OXIDE
Not Available	132-CV-14	VACUUM
142-CV-18	142-CV-14	NITROGEN
Not Available	152-CV-14	CARBON DIOXIDE



1/4" NPT MALE



1/4" NPT MALE

DISS MALE BY NPT FEMALE		
1/8" PART#	1/4" PART#	GAS
102-18F	102-14F	OXYGEN
112-18F	112-14F	AIR
122-18F	122-14F	NITROUS OXIDE
132-18F	132-14F	VACUUM
142-18F	142-14F	NITROGEN



1/4" NPT FEMALE

DISS MALE BY NPT FEMALE	
PART#	GAS
102-77-14	OXYGEN
110-77-14	AIR
122-77-14	NITROUS OXIDE
132-77-14	VACUUM
142-77-14	NITROGEN



1/4" HOSE BARB

DISS MALE BY DISS MALE	
PART#	DESCRIPTION
102-102	Oxygen - DISS 1240, 9/16"



DISS MALE

**DISS BODY ADAPTERS**

DISS FEMALE HEX NUT BY NPT		
1/8" PART#	1/4" PART#	GAS
101-18	101-14	OXYGEN
111-18	111-14	AIR
121-18	121-14	NITROUS OXIDE
131-18	131-14	VACUUM
141-18	141-14	NITROGEN
191-18	181-14	CARBON DIOXIDE
161-18	161-14	INSTRUMENT AIR
151-18	151-14	EVAC



HEX NUT BY NPT

DISS FEMALE HAND TIGHT BY NPT		
1/8" PART#	1/4" PART#	GAS
100-18	100-14	OXYGEN
110-18	110-14	AIR
120-18	120-14	NITROUS OXIDE
130-18	130-14	VACUUM
140-18	140-14	NITROGEN
180-18	180-14	CARBON DIOXIDE
150-18	150-14	EVAC
160-18	160-14	INSTRUMENT AIR



HAND TIGHT BY NPT

DISS FEMALE HEX NUT BY 1/4" HOSE BARB	
PART#	GAS
101-77-14	OXYGEN
111-77-14	AIR
121-77-14	NITROUS OXIDE
131-77-14	VACUUM
141-77-14	NITROGEN
151-77-14	EVAC
181-77-14	CARBON DIOXIDE
198-77-14	HELIUM
161-77-14	INSTRUMENT AIR







HEX NUT BY 1/4" HOSE BARB

DISS FEMALE HAND TIGHT BY 1/4" HOSE BARB	
PART#	GAS
100-77-14	OXYGEN
110-77-14	AIR
120-77-14	NITROUS OXIDE
130-77-14	VACUUM
140-77-14	NITROGEN
150-77-14	EVAC
180-77-14	CARBON DIOXIDE
190-77-14	HELIUM
160-77-14	INSTRUMENT AIR





HAND TIGHT BY 1/4" HOSE BARB

**NPT FITTINGS 200 PSI MAX / TUBING NIPPLES**

HEX NIPPLE		CONNECTOR		COUPLER		90° STREET ELBOW	
							
PART#	DESCRIPTION	PART#	DESCRIPTION	PART#	DESCRIPTION	PART#	DESCRIPTION
MH18-18	1/8" M NPT x 1/8" M NPT	FC18-M18	1/8" F NPT x 1/8" M NPT	F18-F18	1/8" F NPT x 1/8" F NPT	FE18-M18	1/8" F NPT x 1/8" M NPT
MH14-14	1/4" M NPT x 1/4" M NPT	FC18-M14	1/8" F NPT x 1/4" M NPT	F14-F14	1/4" F NPT x 1/4" F NPT	FE14-M18	1/4" F NPT x 1/8" M NPT
MH18-14	1/8" M NPT x 1/4" M NPT	FC14-M18	1/4" F NPT x 1/8" M NPT	F14-F18	1/4" F NPT x 1/8" F NPT	FE14-M14	1/4" F NPT x 1/4" M NPT
		FC14-M14	1/4" F NPT x 1/4" M NPT				

90° ELBOW	
	
PART#	DESCRIPTION
18-ENPT	1/8" F NPT
14-ENPT	1/4" F NPT

WYE BLOCK	
	
PART#	DESCRIPTION
22-18-18	1/8" All Ports
22-18-14	1/8" Inlet, 1/4" Outlets

FEMALE TEE	
	
PART#	DESCRIPTION
T-18-18	1/8" F NPT
T-14-14	1/4" F NPT

POWER TAKE OFF	
	
PART#	DESCRIPTION
P-24	OXYGEN
P-16	MEDICAL AIR

1/4" ID FEMALE NPT TO HOSE BARB	
	
PART#	DESCRIPTION
F-18-77	1/8" NPT Female
F-14-77	1/4" NPT Female

1/4" ID MALE NPT TO HOSE BARB	
	
PART#	DESCRIPTION
M-18-77	1/8" NPT Male
M-14-77	1/4" NPT Male

**MEDICAL GRADE VINYL TUBING**



SWIVEL STYLE TUBING NIPPLE		
		
PART#	Color	Quantity
132EMG	Green	100/Pkg
0137	Yellow	50/Pkg
0135	White	50/Pkg
0135BLU	Blue	50/Pkg
0132BKW	Black/White	50/Pkg
0132BLK	Black	50/Pkg
0138	Clear	50/Pkg

I.D.	O.D.	Wall	Maximum Working Pressure	Item No.
1/8"	1/4"	1/16"	59 @ 70° F	HL-24
3/16"	5/16"	1/16"	51 @ 70° F	HL-35
1/4"	3/8"	1/16"	51 @ 70° F	HL-46
1/4"	7/16"	3/32"	60 @ 70° F	HL-47*
5/16"	7/16"	1/16"	50 @ 70° F	HL-57
3/8"	9/16"	3/32"	50 @ 70° F	HL-69
3/8"	1/2"	1/16"	40 @ 70° F	HL-650
1/2"	5/8"	1/16"	28 @ 70° F	HL-858

\* Suitable for vacuum service, not to exceed 21" Hg. @ 70° F.



**WALL MOUNT RAIL SYSTEM**

\* FAIRFIELD \* HOSPITAL SYSTEMS \* EASTERN \* HILL-ROM \*



\*CHEMETRON

\*OXYGEN

\*OHMEDA

\*MEDICAL AIR

\*PURITAN BENNETT

\*VACUUM

\*MEDSTAR

\*NITROUS OXIDE

\*DISS

Standard 2 Foot Hose - Custom Lengths Available

1 or 2 Outlets or Flowmeters

**WALL MOUNT EXTENSION MANIFOLD**



\*CHEMETRON

\*OXYGEN

\*OHMEDA

\*MEDICAL AIR

\*PURITAN BENNETT

\*VACUUM

\*MEDSTAR

\*NITROUS OXIDE

\*DISS

Standard 2 Foot Hose - Custom Lengths Available

**HORIZON HEADWALL SYSTEMS MODULE**

**HOSE FROM THE BOTTOM**

**CHEMETRON**

Oxygen	Z-42-400
Medical Air	Z-42-410
Vacuum	Z-42-430

**OHIO**

Oxygen	Z-42-500
Medical Air	Z-42-510
Vacuum	Z-42-530

**PURITAN BENNETT**

Oxygen	Z-42-200
Medical Air	Z-42-210
Vacuum	Z-42-230

**DISS**

Oxygen	Z-42-102
Medical Air	Z-42-112
Vacuum	Z-42-132

**HOSE FROM THE BACK**

**CHEMETRON**

Oxygen	ZB-42-400
Medical Air	ZB-42-410
Vacuum	ZB-42-430

**OHIO**

Oxygen	ZB-42-500
Medical Air	ZB-42-510
Vacuum	ZB-42-530

**PURITAN BENNETT**

Oxygen	ZB-42-200
Medical Air	ZB-42-210
Vacuum	ZB-42-230

**DISS**

Oxygen	ZB-42-102
Medical Air	ZB-42-112
Vacuum	ZB-42-132

**HORIZON REPLACEMENT CLIPS**

\*\*\*INCLUDES 3 FOOT DISS CONNECTION HOSE\*\*\*



Oxygen #877  
CLIP ONLY

Medical Air #878  
CLIP ONLY

Vacuum #876  
CLIP ONLY

\$44.50 Each

\$44.50 Each

\$44.50 Each



**PIPE MARKERS AND VALVE TAGS  
ANSI / ASME COMPLIANT**

SOLD PER STICKER

-MEDICAL AIR	41-AIR
-OXYGEN	41-OXY
-NITROGEN	41-NIT
-NITROUS OXIDE	41-N2O
-WAGD	41-WAG
-VACUUM	41-VAC
-CARBON DIOXIDE	41-CO2





**HIGH PRESSURE HOSES AND HOSE ACCESSORIES**

HIGH PRESSURE HOSE	
	
DISS FEMALE x DISS FEMALE, 10 FT LONG	
100-10-100	Oxygen
110-10-110	Air

AIR HOSE CRIMPER	CR-100
	

RESPIRATORY SPACE SAVER	
	
FLOWMETER WITH 10 FT. HOSE	
OHIO	T15-501
PB	T15-201
MEDSTAR	T15-301
CHEMETRON	T15-401
DISS	T15-100

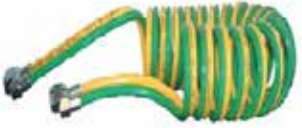
AIR GUN WITH COILED HOSE		
		
OUTLET CONNECTION		
Ohio Medical Air	511-40	\$139.00
Chemetron Medical Air	411-40	\$139.00
Puritan Bennett Medical Air	211-40	\$139.00
DISS Medical Air	112-40	\$139.00
DISS Instrument Air	277-40	\$279.00
DISS Nitrogen	140-40	\$279.00

COILED HIGH PRESSURE HOSES		
		
DUAL COILED HOSE OXYGEN/AIR		
Dual 10' Blender	101-D10-111	\$195.00
Dual 15' Ventilator	100-D15-110	\$229.00
		
SINGLE HOSE 15 FOOT LENGTH		
Oxygen	100-015-100	\$119.00
Air	110-A15-110	\$119.00

HIGH PRESSURE AIR GUN WITH REGULATOR		
		
Air Gun with Coiled Hose and Adjustable Regulator for Wall Outlets		
OUTLET CONNECTION		
Ohio Medical Air	511-42	\$249.00
Chemetron Medical Air	411-42	\$249.00
Puritan Bennett Medical Air	211-42	\$249.00
DISS Medical Air	112-42	\$249.00
DISS Instrument Air	277-42	\$349.00
DISS Nitrogen	140-42	\$349.00

**HIGH PRESSURE BULK HOSE SOLD BY THE FOOT**



- \* Available in custom lengths and configurations
- \* Available in a variety of gasses
- \* Sold by The Foot
- \* 200 PSI Max

GAS	CONDUCTIVE	NON-CONDUCTIVE
OXYGEN	22-01	20-01
MEDICAL AIR	23-01	21-01
VACUUM 1/4"	25-01	
VACUUM 5/16"	32-01	
N2O	24-01	
CO2	28-01	
WAGD 1/4"	24-01	
WAGD 5/16"	33-01	
NITROGEN	44-01	
INSTRUMENT AIR	34-01	
GENERAL PURPOSE	35-01	

**\*\*Hose Lengths Sold By The Foot\*\***

**FERRULE FOR 1/4" HOSE**



Y624A 10/PACK

**HEAVY DUTY HOSE RETRACTOR**



60-64

**STANDARD HIGH PRESSURE HOSE**

Non-Conductive, Respiratory		\$54.00
#100-10-20-100	Green	Oxygen
#110-10-21-110	Yellow	Air
Conductive, OR/ Anesthesia		\$89.00
#100-10-22-100	Green	Oxygen
#110-10-23-110	Yellow	Air
#120-10-24-120	Blue	Nitrous Oxide
#130-10-25-130	White	Vacuum
#140-10-26-140	Black	Nitrogen
#150-10-27-150	Lavender	EVAC
#180-10-28-180	Gray	Carbon Dioxide

**DISS Female x DISS Female, 10 FT Long**



**13" Chord/Hose Wraps \$59.00/10 PACK**



Red	WTV13-R
Blue	WTV13-BL
Black	WTV-13-BK



**PURITAN BENNETT  
BEACON MEDAES SERIES "B" WALL OUTLETS**



Item	Concealed Wall Outlet				
	Gas Service	Color Code	Complete Assembly	Rough-in Assembly	Latch-Valve Assembly
Geometric Quick-Connect (U.S.)	O <sub>2</sub>	White	<input type="checkbox"/> 6-121020-00	<input type="checkbox"/> 6-233110-00	<input type="checkbox"/> 6-230930-00
	N <sub>2</sub> O	Blue	<input type="checkbox"/> 6-121021-00	<input type="checkbox"/> 6-233111-00	<input type="checkbox"/> 6-230931-00
	AIR	Yellow	<input type="checkbox"/> 6-121022-00	<input type="checkbox"/> 6-233112-00	<input type="checkbox"/> 6-230932-00
	VAC	White	<input type="checkbox"/> 6-121023-00	<input type="checkbox"/> 6-233113-00	<input type="checkbox"/> 6-230933-00
	WAGD	Purple	<input type="checkbox"/> 6-121029-00	<input type="checkbox"/> 6-233119-00	<input type="checkbox"/> 6-230939-00

Add "P" to part number for PURITIAN BENNETT  
 Add "C" to part number for CHEMETRON  
 Add "O" to part number for OHIO  
 Add "M" to part number for MEDSTAR/OXEQUIP

**BEACON DISS OUTLETS**

Item	Concealed Wall Outlet				
	Gas Service	Color Code	Complete Assembly	Rough-in Assembly	Latch-Valve Assembly
Series B DISS (U.S.)	O <sub>2</sub>	White	<input type="checkbox"/> 6-121100-00	<input type="checkbox"/> 6-233110-00	<input type="checkbox"/> 6-230910-00
	N <sub>2</sub> O	Blue	<input type="checkbox"/> 6-121101-00	<input type="checkbox"/> 6-233111-00	<input type="checkbox"/> 6-230911-00
	AIR	Yellow	<input type="checkbox"/> 6-121102-00	<input type="checkbox"/> 6-233112-00	<input type="checkbox"/> 6-230912-00
	VAC	White	<input type="checkbox"/> 6-121103-00	<input type="checkbox"/> 6-233113-00	<input type="checkbox"/> 6-230913-00
	N <sub>2</sub>	Black	<input type="checkbox"/> 6-121104-00	<input type="checkbox"/> 6-233114-00	<input type="checkbox"/> 6-230914-00
	Instrument Air	Red	<input type="checkbox"/> 6-121108-00	<input type="checkbox"/> 6-233118-00	<input type="checkbox"/> 6-230916-00
	WAGD	Purple	<input type="checkbox"/> 6-121109-00	<input type="checkbox"/> 6-233119-00	<input type="checkbox"/> 6-230919-00
	CO <sub>2</sub>	Gray	<input type="checkbox"/> 6-121110-00	<input type="checkbox"/> 6-233120-00	<input type="checkbox"/> 6-230920-00

Standard Trim Plate 5"	#6-325161-00	Console Trim Plate 3.25"	#6-325160-00
------------------------	--------------	--------------------------	--------------

**A COMPLETE OUTLET ASSEMBLY NEEDS 3 PART NUMBERS  
(ROUGH-IN ASSEMBLY, LATCH-VALVE ASSEMBLY & TRIM PLATE)**



**CHEMETRON / MEDSTAR WALL OUTLETS**

	CHEMETRON 500 SERIES		
	COMPLETE OUTLET ASSEMBLY	VALVE BODY ASSEMBLY	COVER PLATE
OXYGEN	64-01-5001	64-90-0620	64-91-1501
VACUUM	64-01-5002	64-90-0621	64-91-1502
MEDICAL AIR	64-01-5003	64-90-0620	64-91-1503
NITROUS OXIDE	64-01-5004	64-90-0620	64-91-1504
WAGD	64-01-5006	64-90-0621	64-91-1506
CARBON DIOXIDE	64-01-5007	64-90-0620	64-91-1507
O2/CO2	64-01-5008	64-90-0620	64-91-1508
SLIDE BRACKET	64-06-001		

	DISS OUTLETS 500 SERIES	
	COMPLETE OUTLET ASSEMBLY	REPLACEMENT VALVE KIT
OXYGEN	64-04-5601	64-90-0631
MEDICAL AIR	64-04-5603	64-90-0634
NITROUS OXIDE	64-04-5604	64-90-0633
VACUUM	64-04-5602	64-90-0632
WAGD	64-04-5606	64-90-0638
N2	64-04-5607	64-90-0636
CO2	64-04-5608	64-90-0635

	CHEMETRON 400 SERIES		
	COMPLETE OUTLET ASSEMBLY	REPLACEMENT VALVE KIT	COVER PLATE
OXYGEN	64-20-001	64-90-0180	64-92-0176
MEDICAL AIR	64-20-002	64-90-0180	64-92-0178
NITROUS OXIDE	64-20-006	64-90-0180	64-91-4003
VACUUM	64-20-005	64-90-0181	64-92-0177

	MEDSTAR	
	COMPLETE OUTLET	REPLACEMENT VALVE KIT
OXYGEN	1930-2111	1227-X
MEDICAL AIR	1930-2411	1227-X
NITROUS OXIDE	1930-2311	1227-X
VACUUM	1930-2211	1227-X
WAGD	1930-2811	1227-X
CARBON DIOXIDE	1930-2511	1227-X
SLIDE BRACKET	1857-A	

**OHIO WALL OUTLETS**

**OHIO DIAMOND III / GEMINI**



Concealed Wall Outlet				
Item	Gas Service	Color Code	Rough-In Assembly	Finish Assembly
<b>Wall/Ceiling Quick Connect</b>	O <sub>2</sub>	Green	<input type="checkbox"/> 234510-00	<input type="checkbox"/> 234610-00
	N <sub>2</sub> O	Blue	<input type="checkbox"/> 234511-00	<input type="checkbox"/> 234611-00
	AIR	Yellow	<input type="checkbox"/> 234512-00	<input type="checkbox"/> 234612-00
	VAC	White	<input type="checkbox"/> 234513-00	<input type="checkbox"/> 234613-00
	WAGD	Purple	<input type="checkbox"/> 234519-00	<input type="checkbox"/> 234619-00
<b>Console Quick-Connect</b>	O <sub>2</sub>	Green	<input type="checkbox"/> 234410-00	<input type="checkbox"/> 234810-00
	N <sub>2</sub> O	Blue	<input type="checkbox"/> 234411-00	<input type="checkbox"/> 234811-00
	AIR	Yellow	<input type="checkbox"/> 234412-00	<input type="checkbox"/> 234812-00
	VAC	White	<input type="checkbox"/> 234413-00	<input type="checkbox"/> 234813-00
	WAGD	Purple	<input type="checkbox"/> 234419-00	<input type="checkbox"/> 234819-00
<b>Wall/Ceiling DISS</b>	O <sub>2</sub>	Green	<input type="checkbox"/> 234510-00	<input type="checkbox"/> 234710-00
	N <sub>2</sub> O	Blue	<input type="checkbox"/> 234511-00	<input type="checkbox"/> 234711-00
	AIR	Yellow	<input type="checkbox"/> 234512-00	<input type="checkbox"/> 234712-00
	VAC	White	<input type="checkbox"/> 234513-00	<input type="checkbox"/> 234713-00
	N <sub>2</sub>	Black	<input type="checkbox"/> 234514-00	<input type="checkbox"/> 234714-00
	WAGD	Purple	<input type="checkbox"/> 234519-00	<input type="checkbox"/> 234719-00
	CO <sub>2</sub>	Gray	<input type="checkbox"/> 234520-00	<input type="checkbox"/> 234720-00
<b>Accessories</b>	Vacuum Slide		<input type="checkbox"/> 234500-00	<input type="checkbox"/> 234600-00
	Blanket Outlet		<input type="checkbox"/> 234500-00	<input type="checkbox"/> 234601-00

Medæ's\* and Diamond\* are trademarks of Hillenbrand Industries  
Ohio\* and Ohmeda\* are trademarks of Datex-Ohmeda

**OHIO DIAMOND CARE**

	FINISH ASSEMBLY ONLY		ROUGH-IN ASSEMBLY ONLY	
	OXYGEN	6803-8121-800	OXYGEN	6803-8139-800
	MEDICAL AIR	6803-8121-803	MEDICAL AIR	6803-8139-803
	NITROUS OXIDE	6803-8121-801	NITROUS OXIDE	6803-8139-801
	VACUUM	6803-8121-802	VACUUM	6803-8139-802
Add "C" to part number for CHEMETRON				
Add "P" to part number for PURITAN BENNETT				
Add "D" to part number for DISS				
Add "CL" to part number for CONSOLE MOUNT				

**GAS ANALYSIS & OUTLET VERIFICATION SERVICES**  
**MEDICAL GAS & VACUUM OUTLETS - ALARMS - VALVE BOXES**



- \* Over 30 Years of Testing Experience \*
- \* Complete Documentation for Permanent Records \*
- \* Annual Testing \*
- \* All Testing Performed in Accordance with NFPA 99C \*



**MEDICAL GRADE BALL VALVES/  
LOKRINGS/CHECK VALVES**



BALL VALVES

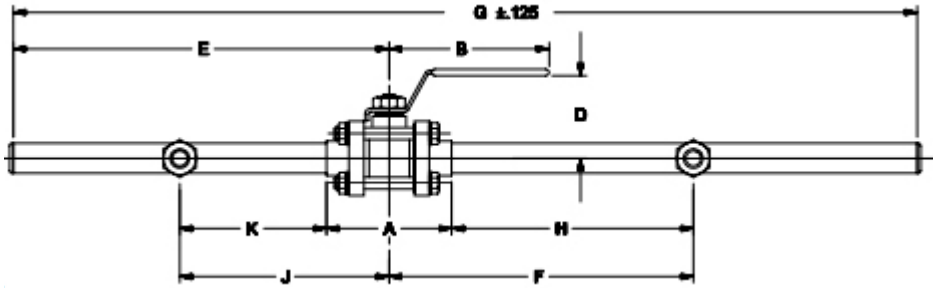

BALL VALVES		DIMENSIONS (Inches)						
Valve Size	Part Number	A	B	D	E	F	G	H
1/2"	41050-01	2.62	3.35	1.69	7.87	6.37	21.00	5.06
3/4"	41075-01	2.93	4.33	1.89	8.25	6.06	21.00	4.60
1"	41100-01	3.44	4.33	2.05	8.58	5.87	21.00	4.15
1-1/4"	41125-01	3.96	5.12	2.56	8.75	5.50	21.00	3.52
1-1/2"	41150-01	4.43	5.12	2.72	8.87	5.37	21.00	3.16
2"	41200-01	5.55	6.30	3.15	10.87	5.00	21.00	2.23
2-1/2"	41250-01	6.73	9.06	4.29	16.00	4.25	32.00	0.89
3"	41300-01	7.56	9.06	4.61	16.00	4.50	32.00	0.72
4"	41400-01	9.80	11.73	7.90	16.00	7.90	32.00	3.00

CHECK VALVE SIZES	
Check-Valve Size	Part Number
3/4"	51075-01
1"	51100-01
1-1/4"	51125-01
1-1/2"	51150-01
2"	51200-01
2-1/2"	51250-01
3"	51300-01
4"	51400-01

**NITROGEN CONTROL PANELS**

**AMICO**  
COMPLETE ASSEMBLY



DISS Male      N-CONP-E-REL  
Schrader Female      N-CONS-E-REL

**Nitrogen Control Retrofit Ohmeda**



Replacement Front Panel Only  
DISS Male      N-CONP-E-OHM  
Schrader Female      N-CONS-E-OHM

**BEACON**

**Nitrogen Control Panel II**



Complete Assembly  
DISS Male      6-120267-01  
Schrader Female      6-120277-0S

**Nitrogen Control Retrofit Ohmeda**



Replacement Front Panel Only  
DISS Male      6-120901-00  
Schrader Female      6-120901-0S

**Nitrogen Control Retrofit Puritan Bennett**



Replacement Front Panel Only  
DISS Male      6-120900-00  
Schrader Female      6-120900-0S

**Nitrogen Control for Ceiling Column**



Replacement Front Panel Only  
DISS Male      6-120396-00  
Schrader Female      6-120396-0S

**ALLIED**







COMPLETE ASSEMBLY

DISS Male      75-20-0005  
Schrader Female      75-20-0007





Replacement Front Panel Only

DISS Male      75-20-0015  
Schrader Female      75-20-0017

**ROLLING STANDS**

Standard MRI Compatible	I.V. Stand with 2 or 4 Hook Top	Rolling Stand with Tray	Universal Vent Stand	Notebook Stand
				
WTMRI-100A	1040-2	#1064 12" Tray	#1059	#1268
1059T Std. Pole/Holder	1040-4	#1065 17.5" Tray		

**STAND ACCESSORIES**

Multi-Use Basket	360 Support Handle	Dual Cylinder Holders		Bag Hook
				
12 x 8 x 6 1034	#1048-10	#1044	#1044-1	#1047
12 x 12 x 8 1035				

**EMERGENCY PREPAREDNESS**

10 Flowmeter Mounting Bracket With 15' Hose







**O2 Supply Manifold PM106**

**O2 Supply Manifold PM106-KIT**



**Includes:**  
**Hose**  
**6 Flowmeters 0-15L**  
**6 Masks**

**POLE BRACKET ASSEMBLIES**

		
Ohio Continuous Suction Regulator With 10' Hose	H-3-PMB	
Ohio Intermittent / Continuous Suction Regulator With 10' Hose	H-2-PMB	
Oxygen Flowmeter With 10' Hose	15-102-PM	



**CYLINDER CARTS & STANDS**

D & E Size Carts		
		
PART#	DESCRIPTION	PRICE
B-6105	Standard	\$39.50
B-6105-2U	Standard, Box of 2	\$59.00
B-6C105	Chrome	\$44.00
MRI-1AA	Non-Magnetic	\$179.00
B-6205	Dual Cylinder	\$89.00



H Cylinder Carts		
		
SINGLE CART	DESCRIPTION	PRICE
B-6110	Standard	\$289.00
MRI B-6108	Non-Magnetic	\$489.00
DUAL CART	DESCRIPTION	PRICE
B-6210	Standard	\$329.00

D & E Cylinder Stands		
PART#	DESCRIPTION	PRICE
B-6040	Cylinder Capacity: 4	\$89.00
B-6060	Cylinder Capacity: 6	\$99.00
B-6120	Cylinder Capacity: 12	\$119.00
B-6180	Cylinder Capacity: 18	\$149.00
B-6240	Cylinder Capacity: 24	\$179.00



2 Wheel	Multiple D & E Carts & Stands			4 Wheel
				
2 Wheel				
B-6041	Cylinder Capacity:	4	\$149.00	
B-6061	Cylinder Capacity:	6	\$169.00	
B-6121	Cylinder Capacity:	12	\$179.50	
4 Wheel				
B-6064	Cylinder Capacity:	6	\$196.00	
B-6124	Cylinder Capacity:	12	\$219.00	
B-6184	Cylinder Capacity:	18	\$229.00	
B-6246	Cylinder Capacity:	24	\$269.00	

**CARBON DIOXIDE HIGH PRESSURE REGULATORS**

CARBON DIOXIDE REGULATORS WITH FLOWMETERS			
<b>100% CARBON DIOXIDE</b>			Replacement CO2 Flowmeter 0-12LPM
0-12 LPM Flowmeter			
50-940-18 Small Cylinder Yoke	940 CGA	\$329.00	 <p>\$139.00</p>
50-320-18 Large Cylinder Nut	320 CGA	\$289.00	
<b>CARBON DIOXIDE &gt; 7% &amp; OXYGEN</b>			
0-12 LPM Flowmeter			
50-940-18 Small Cylinder Yoke	940 CGA	\$329.00	<p>Starts at 1/2 Liter Part # 18-CO2</p>
50-500-18 Large Cylinder Nut	500 CGA	\$329.00	
<b>CARBON DIOXIDE &lt; 7% &amp; OXYGEN</b>			
0-12 LPM Flowmeter			
50-880-18 Small Cylinder Yoke	880 CGA	\$329.00	
50-280-18 Large Cylinder Nut	380 CGA	\$329.00	

50 PSI PRESET CARBON DIOXIDE REGULATORS		
		
<b>100% CARBON DIOXIDE</b>		
50-940 Small Cylinder Yoke	940 CGA	\$329.00
50-320 Large Cylinder Nut	320 CGA	\$329.00
<b>CARBON DIOXIDE &lt;7% &amp; OXYGEN</b>		
50-880 Small Cylinder Yoke	880 CGA	\$329.00
50-280 Large Cylinder Nut	380 CGA	\$329.00
<b>CARBON DIOXIDE &gt; 7% &amp; OXYGEN</b>		
50-940 Small Cylinder Yoke	940 CGA	\$329.00
50-500 Large Cylinder Nut	500 CGA	\$329.00

ADJUSTABLE CARBON DIOXIDE REGULATORS					
ADJUSTABLE 0-100 PSI			ADJUSTABLE 0-30 PSI With Tubing Nipple Clinical Instrumentation		
					
<b>100% CARBON DIOXIDE</b>			<b>100% CARBON DIOXIDE</b>		
100-940 Small Cylinder Yoke	940 CGA	\$329.00	30-940 Small Cylinder Yoke	940 CGA	\$329.00
100-320 Large Cylinder Nut	320 CGA	\$329.00	30-320 Large Cylinder Nut	320 CGA	\$329.00
<b>CARBON DIOXIDE &lt; 7% &amp; OXYGEN</b>			<b>CARBON DIOXIDE &lt;7% &amp; OXYGEN</b>		
100-880 Small Cylinder Yoke	880 CGA	\$329.00	30-880 Small Cylinder Yoke	880 CGA	\$329.00
100-280 Large Cylinder Nut	380 CGA	\$329.00	30-280 Large Cylinder Nut	380 CGA	\$329.00
<b>CARBON DIOXIDE &gt; 7% &amp; OXYGEN</b>			<b>CARBON DIOXIDE &gt; 7% &amp; OXYGEN</b>		
100-940 Small Cylinder Yoke	940 CGA	\$329.00	30-940 Small Cylinder Yoke	940 CGA	\$329.00
100-500 Large Cylinder Nut	500 CGA	\$329.00	30-500 Large Cylinder Nut	500 CGA	\$329.00

**OXYGEN \* MEDICAL AIR \* NITROUS OXIDE  
HIGH PRESSURE REGULATORS**

50 PSI PRESET REGULATORS		
		
<b>OXYGEN</b>		<b>\$159.00</b>
50-870	Small Cylinder Yoke	870 CGA
50-540	Large Cylinder Nut	540 CGA
<b>AIR</b>		<b>\$179.00</b>
50-950-08	Small Cylinder Yoke	950 CGA
50-346-08	Large Cylinder Nut	346 CGA
<b>NITROUS OXIDE</b>		<b>\$289.00</b>
50-910	Small Cylinder Yoke	910 CGA
50-326	Large Cylinder Nut	326 CGA

0-100 PSI ADJUSTABLE REGULATORS		
		
<b>OXYGEN</b>		<b>\$199.00</b>
100-870	Small Cylinder Yoke	870 CGA
100-540	Large Cylinder Nut	540 CGA
<b>AIR</b>		<b>\$249.00</b>
100-950	Small Cylinder Yoke	950 CGA
100-346	Large Cylinder Nut	346 CGA
<b>NITROUS OXIDE</b>		<b>\$289.00</b>
100-910	Small Cylinder Yoke	910 CGA
100-326	Large Cylinder Nut	326 CGA

**HELI-OX HIGH PRESSURE REGULATORS \$329.00**

0-100 PSI ADJUSTABLE		
		
<b>100% HELIUM</b>		
100-930	Small Cylinder Yoke	930 CGA \$329.00
100-580	Large Cylinder Nut	580 CGA \$329.00
<b>HELIUM &lt;80%</b>		
100-890	Small Cylinder Yoke	880 CGA \$329.00
100-280	Large Cylinder Nut	280 CGA \$329.00
<b>HELIUM &gt; 80%</b>		
100-930	Small Cylinder Yoke	930 CGA \$329.00
100-500	Large Cylinder Nut	500 CGA \$329.00



**REPLACEMENT  
0-16 LPM  
HELI-OX  
FLOWMETER  
Part # 65-HE  
\$139.00**

50 PSI PRESET		
		
<b>100% HELIUM</b>		
50-930-65	Small Cylinder Yoke	930 CGA \$329.00
50-580-65	Large Cylinder Nut	580 CGA \$329.00
<b>HELIUM &lt;80%</b>		
50-890-65	Small Cylinder Yoke	880 CGA \$329.00
50-280-65	Large Cylinder Nut	280 CGA \$329.00
<b>HELIUM &gt; 80%</b>		
50-930-65	Small Cylinder Yoke	930 CGA \$329.00
50-500-65	Large Cylinder Nut	500 CGA \$329.00

**HIGH PRESSURE NITROGEN REGULATORS**

								
Adjustable, 0-200 PSI, Diaphragm 2" Gauges with DISS Outlet			Adjustable, 0-200 PSI, Diaphragm 2" Gauges & Schrader Female			Adjustable, 0-200 PSI, Diaphragm 2" Gauge, Schrader Coupler & DISS		
\$389.00			\$389.00			\$489.00		
200-960-142	Small Cylinder Yoke	960 CGA	200-960-610	Small Cylinder Yoke	960 CGA	200-960-610-142	Small Cylinder Yoke	960 CGA
200-580-142	Large Cylinder Nut	580 CGA	200-580-610	Large Cylinder Nut	580 CGA	200-580-610-142	Large Cylinder Nut	580 CGA

**LOW PRESSURE NITROGEN REGULATORS \$469.00**

WALL MOUNTED	
	
Elbowed Schrader Male to Schrader Female Coupler	615-610
Elbowed Schrader Male to DISS Male Coupler	615-142
Elbowed DISS Female to DISS Male	144-142
Elbowed DISS Female to Schrader Female	144-610

COLUMN MOUNTED	
	
Schrader Male to Schrader Female Coupler	612-610
Schrader Male to DISS Male Coupler	612-142
DISS Female to DISS Male	140-142
DISS Female to Schrader Female	140-610

N2 Regulator With Flowmeter High Pressure	
Large Cylinder	50-580-112
Small Cylinder	50-960-112



REPLACEMENT REGULATOR KNOB ASSEMBLY	
	
Assembly	\$239.00 11-91-0170
Knob Only	\$69.00 11-91-0172



Davol Arthro-Flo Regulator	
	
0037760	\$925.00





**NITROGEN ACCESSORIES**

	NITROGEN HOSE ASSEMBLIES \$239.00		
	611-20-26-610	20 FT Nitrogen Hose	Schrader Male x Schrader Female
	140-20-26-610	20 FT Nitrogen Hose	DISS Nitrogen x Schrader Female
	140-20-26-140	20 FT Nitrogen Hose	DISS Nitrogen x DISS Nitrogen

	NITROGEN FLEXIBLE CONVERTER HOSE		<b>Schrader Elbow Quick Connect</b>	
	Air for Nitrogen to DISS Quick Connect			
	55-1-610		55-E-610	

	NITROGEN WYE ASSEMBLIES		\$289.00	<b>SCHRADER WYE</b> 
	DISS Female x DISS Male		140-142-142	
	DISS Female x Schrader Female		140-610-610	
	Schrader Male x Schrader Female		612-610-610	
	Schrader Male x DISS Male		612-142-142	

SCHRADER MALE QUICK CONNECT	
Air / Nitrogen 1/8" NPT	
	
Swivel Style Quick Connect N2	611-18
Non Swivel Quick Connect N2	112-18

DISS Female Nitrogen 1/4" NPT		
Hand Tight	140-14	
Hex Nut	141-14	

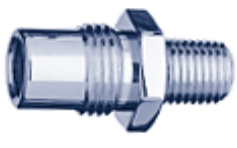
	SCHRADER FEMALE COUPLER AIR FOR NITROGEN 1/4" NPT	
	610-14	
	DISS MALE NITROGEN 1/4" NPT	
	DISS Male with Check	142-14-CV
	DISS Male without Check	142-14

BLACK NITROGEN 2 PIECE KIT	
For Nitrogen Only	
	
640-641-2	

	BLACK SCHRADER NITROGEN WYE	
	DISS Inlet	22-640-140
	Schrader Inlet	22-641-641

**OUTLET ACCESSORIES / WALL OUTLET TESTER**



Hospital Wall Outlet Test Gauge for Checking Gas Line Flow & Pressure ALL \$369.00							
OUTLET	O2	AIR	N2O	VAC	N2	INST AIR	
DISS	20-DT	21-DT	24-DT	25-DT	26-DT	34-DT	
OHIO	20-OT	21-OT	24-OT	25-OT	26-OT	34-OT	
CHEMETRON	20-CT	21-CT	24-CT	25-CT	26-CT	34-CT	
MEDSTAR	20-MT	21-MT	24-MT	25-MT	26-MT	34-MT	
PURITAN BENNETT	20-PT	21-PT	24-PT	25-PT	26-PT	34-PT	



MASTER ALARM PRESSURE / VACUUM SWITCH		
DEMAND CHECK FITTINGS (GAS SPECIFIC)		
	ALLIED	BEACON
OXYGEN	13-0100	6-129030-10
MEDICAL AIR	13-0103	6-129030-12
NITROUS OXIDE	13-0102	6-129030-11
CARBON DIOXIDE	13-0104	6-129030-20
VACUUM	13-0107	6-129030-13
WAGD	13-0107	6-129030-19
NITROGEN	*13-0105	6-129030-14
INSTRUMENT AIR	*13-0130	6-129030-18
*Requires 2 Switches		

**O-Ring Lubricant**



64-90-2111

For Medical Gas & Vacuum Outlets

**ENVIROVAC**



64-90-VAC

Outlet Cleaner

**Zone Valve Box Replacement Gauges**

1.5" Gauge  
1/8" NPT Back Port

100 PSI	MG-BW-70
300 PSI	MG-BW-71
30 In/Hg	MG-BW-72



**4 1/2" Gauge With 1/4" NPT**

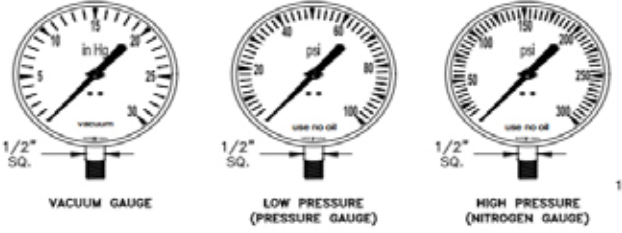

Steel-Case Gauges	
Part Number	Item
<input type="checkbox"/> 6-130111-00	Vacuum Gauge (30 in. Hg)
<input type="checkbox"/> 6-130112-00	Low Pressure Gauge (0-100 psi)*
<input type="checkbox"/> 6-130113-00	High Pressure Gauge (0-300 psi)*

**MASTER ALARM**

1/4" or 1/8" NPT x DISS Gas Fitting with Check Valve (GAS SPECIFIC)





Sold as a 2 Piece Kit





OXYGEN	MA-102-101
MEDICAL AIR	MA-112-111
NITROUS OXIDE	MA-122-121
NITROGEN	MA-142-142
CARBON DIOXIDE	MA-182-181
INSTRUMENT AIR	MA-162-161
VACUUM	MA-132-131
WAGD	MA-152-151





**PRESSURE AND VACUUM GAUGES \$39.00**

		Gauge with Rubber Protector 	MG-C2	4000 PSI	2" OD	1/4" NPT	Chrome
			MG-C3	100 PSI	1 1/2" OD	1/8" NPT	Chrome
			MG-C4	100 PSI	2" OD	1/4" NPT	Chrome
			MG-C7	15 LPM	2" OD	1/4" NPT	Chrome
			MG-C23	4000 PSI	1 1/2" OD	1/8" NPT	Chrome
			MG-C75	3000 PSI	1 1/2" OD	1 1/2" NPT	Chrome
			MG-C75P	3000 PSI	1 1/2" OD	1 1/2" NPT	Chrome

	MG-C29		MG-C58		MG-C14
		Gomco 300 Gauge 01-90-3059			

BOTTOM PORT					BACK PORT				
<b>MG-C9</b>	4000 psi	2" OD	1/4" NPT	Chrome	<b>MG-B57</b>	100 psi	1-1/2" OD	1/8" NPT	Black
<b>MG-C11</b>	100 psi	2" OD	1/4" NPT	Chrome	<b>MG-B59</b>	300 psi	1-1/2" OD	1/8" NPT	Black
<b>MG-C13</b>	4000 psi	1-1/2" OD	1/8" NPT	Chrome	<b>Replacement Lenses</b>				
<b>MG-C14</b>	30 psi	2" OD	1/4" NPT	Chrome	<b>MGL-15</b>	Screw-On Type for 1-1/2" Chrome Gauges			
<b>MG-C15</b>	60 psi	2" OD	1/4" NPT	Chrome	<b>MGL-15WS</b>	Snap-In Type for 1-1/2" Gauges			
<b>MG-C16</b>	200 psi	2" OD	1/4" NPT	Chrome	<b>MGL-20</b>	Screw-On Type for 2" Chrome and Black Gauges			<b>MGL-70</b>
<b>MG-C17</b>	400 psi	2" OD	1/4" NPT	Chrome					Snap-In Type for 2-1/2" Section Gauges
<b>MG-C18</b>	600 psi	2" OD	1/4" NPT	Chrome	<b>NITROUS OXIDE Blue face w/white letters</b>				
<b>MG-C19</b>	1000 psi	2" OD	1/4" NPT	Chrome	<b>VACUUM</b>				
<b>MG-C29</b>	2000 psi	2" OD	1/4" NPT	Chrome	<b>MG-C58</b>	30 inHg Vac	1-1/2" OD	1/8" NPT	Chrome
<b>MG-C30</b>	100 psi	2" OD	1/4" NPT	Chrome	<b>MG-B76</b>	200 mm HG/	2" OD	1/8" NPT	Black
						Back Port			
						Bottom Port			

**REPLACEMENT SUCTION REGULATOR GAUGES \$89.00**

			
BOEHRINGER 1/8" NPT	OHIO/ OHMEDA	PRECISION	CHEMETRON
BG-300	HG-300	PG-300	CG-300
OXEQUIP 1/4" NPT			
OX-300			



**INSUFFLATOR**

**DISS x DISS Female**  
5Ft CO2 200 PSI



180-5-28-180

**Insufflator Yoke**



94-06

**Male Connector**



19-276

**Insufflator High Pressure Hose**  
3000 PSI



716-3-716

**High Pressure Hose 2 Tank Hook-Up 3000 psi Max With 2 Contents Gauges**



G2-716-31-03

**PIN-INDEXED YOKE**



PART#	GAS	CGA
870-14	Oxygen	870
880-14	CO2	880
910-14	N2O	910
940-14	CO2-O2	940
950-14	AIR	950
960-14	N2	960
973-14	GAS MIX	973
930-14	HELI-OX	930
890-14	GAS MIX	890

**H-TANK HEX NUT AND NIPPLE**



PART#	GAS	CGA
280-14	HELI-OX	280
236-14	N2O	236
346-14	AIR	346
500-14	GAS MIX	500
540-14	OXYGEN	540
580-14	N2 & HELI	580
320-14	CO2	320

**TEFLON TAPE**



TFE-40

**Leak Test Solution**



LD-8

**FLEXIBLE STAINLESS STEEL PIGTAILS**  
\*OXYGEN \* MEDICAL AIR \* NITROUS OXIDE \* NITROGEN \* CARBON DIOXIDE \*



\$239.00  
3000 PSIG

FOR MANIFOLD REPLACEMENT		Flexible Stainless Steel Pigtail
30" Long with One Way Check Valve		
326-32-326	CGA 326	Nitrous Oxide
346-32-346	CGA 346	Medical Air
580-32-580	CGA 580	Nitrogen
540-31-540	CGA 540	Oxygen (Copper Only)
320-32-320	CGA 320	Carbon Dioxide

Custom Configurations Available Upon Request



\$349.00  
3000 PSIGM

MULTIPLE CYLINDER TANK HOOKUP		
30" Long with Coupler Tee		
T326-30-326	CGA 326	Nitrous Oxide
T346-30-346	CGA 346	Medical Air
T580-30-580	CGA 580	Nitrogen
T540-31-540	CGA 540	Oxygen (Copper Only)
T320-30-320	CGA 320	Carbon Dioxide



**CABLES / FINGER PROBES**

# SpO2 Reusable

- **Reusable finger probes**  
*(12 month warranty)*
- **Multi-site probes**  
*(6 month warranty)*
- **Ear probes**  
*(6 month warranty)*
- **Soft, comfortable fit**
- **Compatible with most commonly used oximeter systems**



**SpO2 Finger Sensor**  
*12 month warranty*



**Small Finger Sensor**  
*12 month warranty*



**SpO2 Ear Sensor**  
*6 month warranty*



**SpO2 "Y" Sensor**  
*6 month warranty*

We Have Sensors, Probes and Cables for the Following Oximeter Systems

- |                  |               |
|------------------|---------------|
| -Hewlett Packard | -Kontron      |
| -Nonin           | -Ohmeda       |
| -Siemens         | -S & W        |
| -Inovo           | -Nellcor      |
| -Novamatrix      | -SensorMedics |
| -SpaceLabs       |               |



tollos™

EQUIPPED FOR LIFE

ceiling lifts



**CIRRUS LIFT SERIES**



- Electric fixed ceiling lift available in 400, 600 or 700 lb capacity
- Manual or power transverse options
- 6-point spreader bar for enhanced patient comfort
- Can be used with exclusive "Curtain Track Solution"
- Smart sleep mode function to conserve battery power
- Low-profile Cirrus LP version accommodates 8-ft ceilings.



**PINNACLE LIFT SERIES**



- Electric fixed ceiling lift with 1,000 lb capacity to safely and effectively reposition bariatric patients
- Manual or power transverse options
- Oversize spreader bar for superior bariatric comfort
- Can be used with exclusive "Curtain Track Solution"
- Visual and audible low battery indicators



**STRATUS LIFT SERIES**



- Portable ceiling lift available in 600 and 750 lb capacity can easily be moved from room to room
- 6-point spreader bar for enhanced patient comfort
- Long travel height enables lifting patient from floor
- Optional cart for relocation
- Optional infection control strap available

mobile lifts



**ULTRALIFT 3510XH**



- Mobile floor lift available in 600 or 750 lb capacity
- Extra long boom eliminates patient contact with the lift
- Standard 6-point spreader bar for superior sling adjustability
- Extra-low base option allows access beneath all low beds
- Optional integrated digital scale provides 6" of extra height vs. external scale



**STEADY AID SERIES**



- Sit-to-stand lift available in 350, 450 and 750 lb capacity
- All electric with powdered base widening
- Removable foot plate for ambulation
- "Gel Foam" head protector and kneepad for patient safety
- Optional integrated digital scale

slings & accessories

Tollos carries a wide variety of slings to assist in transferring, repositioning and ambulation.

Most slings are available in reusable and single patient use high quality fabrics to achieve the highest in patient comfort.

Customized slings are also available upon request



also available

ULTRA MOVE

TITAN-X

VEHICLE EXTRACTOR

ULTRALIFT 2000 

Many Tollos lifts include our innovative iQ Technology™ and software. Combining proprietary electronics and an optional integrated scale, iQ Technology automates the tracking of critical safe patient handling data for training, compliance and equipment diagnostics. Maintenance features include a constant alert after 1,000 lifts and failsafe shutdown after 6,000 cycles.

## infection control



### ANTI-BACTERIAL INFECTION CONTROL CURTAINS - DISPOSABLE

- Non-woven 100% polypropylene, 100gsm improves infection control
- Inhibits growth of E. Coli and Staphylococcus aureus
- Disposable and recyclable, so curtains can always look fresh and new
- Quick-Fit option significantly reduces hanging times
- Identification label to record date of last change, further improving infection control efforts



### DISPOSABLE INFECTION CONTROL LINEN

- Draw sheets, fitted sheets, stretcher covers, blankets and pillow cases
- Eliminates problems and risks related to collecting and washing reusable linen
- Hygienic solution for remote areas where pick-up of dirty linen is infrequent
- No need for record keeping and quality assurance related to reusable linen contamination
- Affordable option to reusable linen wash costs

## lateral transfer



### SALLYSLIDES®

- Reusable and single-patient use sheets and tubes
- Multi-directional slide tubes are a single, silicon tubular sheet designed to safely move the patient during transfer, in-bed repositioning, lateral transfer, pivoting and rolling
- Multi-directional slide sheets are a two-sheet set to reduce friction during lateral transfer and repositioning
- Proven slipperiness after 250 washes, single-patient use can last up to 4 months, reducing costs.

## scale technologies



### PHYSICIAN SCALES

- Lightweight but durable
- Available in several models to fit almost any setting

#### Eye-Level Models

Equipped with adjustable height rod

#### Waist-Level Models

Easy-to-read digital display

#### Personal Floor Models

Large, stand-alone Titanium indicator with built-in bracket for wall, table or floor mounting

#### Floor-Level Models

Under 13" height; easy to store

#### Ultrasonic BMI Scale

Ultrasonic measuring device

## hygiene solutions



### RANE BATHING SYSTEMS

- Multiple models to suit facility needs
- AirSpa anti-scald valve and on-board disinfection unit standard on all tubs

#### RR7-II Atlantic

Reclining, high-efficiency tub

#### RS8 Geneva

Supine tub with height adjustment

#### RB14 Mediterranean

Bariatric side-entry tub

#### RK12 Winnipeg

Freestanding side-entry tub



### SHOWER TROLLEYS

- Shower, transport and treatment trolleys available in 330, 400 and 1000 lb capacity
- Foot-controlled central locking caster brakes for steering
- Folding side rails for transfer
- Optional battery-operated tilt feature

# EQUIPMENT REPAIR SERVICES

**\*\*CALL US TODAY FOR EQUIPMENT REPAIR PICK-UP\*\***

Medical Gas  
Regulators & Flowmeters



Oxygen  
Medical Air  
Heli-Ox



Carbon Dioxide  
Nitrogen  
Nitrous Oxide

Suction Regulators



Repair or Upgrade Your  
Overflow Safety Trap

**\$39.50**

*Call For  
Estimates*



\* Chemetron \* Ohmeda \* \* Precision Medical \* Boehringer \*

Air/Oxygen Blenders

Overhauls  
Water Traps  
Hoses  
Brackets



Bird - Bio Med Devices - Precision Medical  
*Recommended Overhall every 2 years*

**FULL LINE OF CUSTOM HOSES**

**AVAILABLE**

\*High Pressure Hoses \*Hose  
Assemblies\*Surgey\*

**\*Anesthesia\*Respiratory\***

**Thank You Kevin McDermott**

**(708)369-3675**

**KMCDMED@AOL.COM**



Oxygen Analyzers & Monitors  
Replacement Sensors



MiniOx \* Hudson \*Maxtec

Ventilator Support Arms



Horizon Gas Block Sales and Service



Laryngoscope  
Blades & Handles

\* Replacement\*  
Lamps



Cufflators



Manometers

Respirometers



Wright -Boehringer-Haloscale

Percussors



General Physiotherapy  
Meds Systems



# SHUTDOWN SERVICE

## 350 SUCTION PUMPS



**Table Top & Floor Units Available**



**\*READY FOR PATIENT USE\***

## OVER 200 CYLINDER CARTS



**DUAL & SINGLE H CYLINDER CARTS**

## 500 REGULATORS

**-AIR-OXYGEN-NITROUS OXIDE-  
-NITROGEN--CARBON DIOXIDE-**



**WE HAVE ALL OF THE SHUTDOWN EQUIPMENT YOU NEED**

## 70 AIR COMPRESSORS



**\*PIGTAILS  
\*WYES  
\*HOSES  
\*CANISTERS**

**\*Let ValueMed Be Part Of Your Emergency Backup Plan\***

### Emergency Services

**Inservice and Patient Set Up  
Planning and Consulting**

## GAS CERTIFICATION

### INSTANT REPORTS



- Outlet Testing-
- Lab Hoods-
- Contaminant & Particulate Testing-
- Gas Concentration Zone Valve Verification-
- Alarm Verification-
- Manifolds-
- Vacuum Pumps and O2 Compressors-
- Bulk Systems-
- Proper Labeling-
- Employee Exposure Testing-

## FULL BIOMED DEPARTMENT

- \*We offer ON-SITE & DEPOT level support\*
- \*Preventive Maintenance\*
- \*As Needed Service\*
- \*Repairs\*

We are capable of servicing the following Ventilators

Viasys-Puritan Bennett-Respironics  
Siemens/Maquet-Pulmonetics-Vapotherm  
VersaMed-Hamilton Medical-Drager  
Newport Medical Instruments



# GAS ANALYSIS & OUTLET VERIFICATION

**\*\*Member of the NFPA\*\***

**NFPA 99 requires that after any renovation, modification or addition, a medical gas or vacuum system is to be inspected in accordance with the standards set by the NFPA.**

**\*\*NFPA 99 & NFPA 55 REQUIRE ANNUAL OR SEMI-ANNUAL\*\***

**\*\*INSPECTIONS OF PATIENT CARE FACILITIES\*\***

## ValueMed Offers Many Different Testing Options

\*Medical Gas Outlets- Function & Operation

- Oxygen
- Medical Air
- Nitrous Oxide
- Nitrogen
- Carbon Dioxide
- Instrument Air
- Vacuum
- WAGD



\*Zone Valves-Function & Operation

\*Alarm Panels-Area and Master-Function & Operation

\*Medical Gas Manifolds-Function & Operation

\*Medical Air Compressor-Function & Operation

\*Medical Vacuum Pump-Function & Operation

\*Medical Gas Purity Analysis

\*Dew Point Determination

\*Trace Gas Analysis

\*Lab Hoods-Function & Operation

\*Carbon Monoxide Safety Tests

\*Methane Safety Tests

\*Trace Hydrocarbons Safety Tests

\*Employee Exposure Monitoring

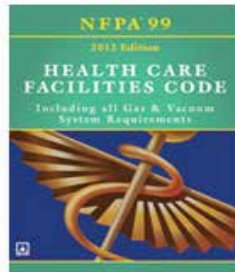

Current Code Book  
PART # NFPA-HCFC



## Full line of Shutdown Equipment

**-Carts-Regulators-Suction Pumps-**

**-Oxygen-Air-Nitrous Oxide-**

**STATE OF THE ART EQUIPMENT  
& QUALIFIED TECHNICIANS**



MBIV

**\*Reports Prepared Instantly\***

**\*Purity Results On Site\***





**YOUR MEDICAL HARDWARE SPECIALISTS**

**708-369-3675 - 24 HOUR SERVICE**

**888-998-VMED (8633)**

## RESPIRATORY EQUIPMENT

**\* RENTALS \* REPAIRS \* SERVICE \* SHUTDOWNS \***



**VENTILATORS**

\*SERVO I



\*840



**NON-INVASIVE VENTILATORS**

V60 BIPAP



BIPAP VISION

## SHUTDOWN SERVICES

### VAPOTHERM

PRECISION FLOW WITH IV STAND



*LET US HELP WITH YOUR EMERGENCY AND PLANNED SHUTDOWNS*

**COMPRESSORS AND SUCTION PUMPS**



**CYLINDER CARTS**



*DUAL & SINGLE CARTS AVAILABLE*

**REGULATORS**



### COUGH ASSIST



### SHUTDOWN EQUIPMENT

- \* REGULATORS/ PIGTAILS
- \* CYLINDER CARTS
- \* HOSES
- \* AIR COMPRESSORS
- \* SUCTION PUMPS
- STAND & TABLE TOP

**YOUR MEDICAL HARDWARE SPECIALISTS**

**24 HOUR SERVICE**

**888-998-VMED (8633)**



**TO PLACE AN ORDER:**

**PHONE: 888-998-8633**

**FAX: 888-676-0711**

or

**EMAIL: [Valuemed.sales@gmail.com](mailto:Valuemed.sales@gmail.com)**

We are currently providing service and sales to: Franciscian Alliance, Ascension, Indiana University, US Department of Veteran Affairs, Presence, University Of Wisconsin, NorthShore Health Systems, Vanguard, Aurora Healthcare, CHS, Cadence, Trinity, Wheaton Franciscan, Rush, Kindred, Community Health Systems, Advocate, and Adventist Group.

We would like to be your *Valued* partner in healthcare!

Our biomedical services are supplied to Aramark, Advocate Clinical Engineering, Crothall, GE, Jannx Medical Systems and Trimedx.



**PayPal**

