



Prices effective July 5, 2023

Published July 2023

Mirra® 2 Chairs

HermanMiller list prices shown are in USD. For HermanMiller Canadian prices, multiply the USD list price by a factor of 1.20---effective July 2023.

Introduction	page 2
Mirra® 2 Chairs	3
Work Chairs	5
Stools	11
Accessories	14
Indices	19
By Name	19
By Number	21
Appendices	
20-Day or Less/Assigned Lead-Time Order Information	
Casters and Glides	
Fire Retardancy-Seating	
Proprietary Textiles Application Chart-Seating	
Proprietary Textile Colors-Seating	
For the latest materials information, refer to the Materials pages on HermanMiller.com.	

Introduction

A Note on the Organization of This Book

There are a few signals that will help you understand the organization of this book. Once you know them, you should be able to find your way around easily.

Like a newspaper, this book is formatted with columns of text and illustrations that run vertically.

Information wraps from one column to the next and continues for as many pages as it needs to.

Black bars are clues.

A black bar at the top of a page signals the start of information about a product.

This information is divided into two sections, each signaled by a black bar. Product Information includes a description, additional notes, and dimensional drawings. Specification Information, which always begins at the top of a column, includes a series of steps. Each step represents a decision you need to make in order to complete your product number. Steps must be followed sequentially. The number of pages needed to complete information on a product varies; some will be complete in one page; others may fill three or four pages. Just continue going through the steps until you run into the next product, signaled by the black bar at the top of the page.

Black tabs running along the outside edge of the page help you locate what section you are in or what section you want to go to. You can thumb forwards or backwards to find a section; tabs and text appear on both sides of the page.

The additional pages in the back of the book include the appendices and indices. They are signaled by a long black bar running along the outside edge of the page.

The index is presented two ways.

The first index is in alphabetical order by product name. It can be helpful if you are new to the products and numbering scheme or if you are looking for a type of product, such as work chair or round table.

The second index is by product number. It lists, in alphanumeric order, the base product number, typically a five-digit number.

General Information

This book is effective July 5, 2023, subject to change without notice. Products may be purchased from authorized Herman Miller dealers who will quote prices upon request. For more information about our products and services or to see a list of dealers, visit www.HermanMiller.com.

All prices are list prices. Additional services, such as planning services, design, storage, and installation, are not included and must be added to these prices when the additional services are requested.

Illustrations, specifications, and prices are based on the latest information at the time of publication. The right is reserved to make changes at any time without notice in prices, fabrics, finishes, materials, specifications, and models, and also to discontinue models and finishes.

Dimensions shown in the drawings are engineering drawing dimensions rounded up to the nearest $\frac{1}{8}$ ". Product is shipped set up or knocked down. Products that include "Shipped knocked down" in the description require some assembly. If this statement does not appear in the description, the product is shipped assembled.

Service problems are normally handled by a Herman Miller authorized dealer. Where this cannot be accomplished on a local level, service problems should be referred to the Customer Care Representative for your region, Herman Miller, Inc., Zeeland, Michigan 49464.

20-Day or Less/Assigned Lead-Time Shipments

All products and options in this price book not designated by an Assigned Program icon  will ship in **20 business days or less** after being acknowledged by Herman Miller.

Products and options designated by an  are on the assigned lead-time program and may ship in 20 days, less than 20 days, or more than 20 days from order acknowledgement.

Work Chairs

Stools

Accessories



Mirra® 2 Work Chair

MRF11
MRF12
MRF13

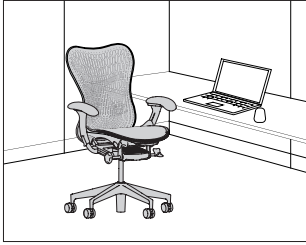

Product Information

Description

This chair has 2 backrest options. The Butterfly Back™ creates an intelligent support structure for the user's entire back. It utilizes a new method for merging a fabric layer with flexible polymer shell. The TriFlex™ 2 back is 100% polymer, no fabric, with a similar design that offers flexible and continuous support. These options, combined with the new loop spine design and passive PostureFit® sacral support allow for a new level of personal contouring and micro-motion support, with the Butterfly Back offering the highest level of comfort. The AireWeave™ seat-suspension material is lightweight and breathable and evenly distributes the user's weight over the seat of the chair. The chair's Harmonic™ 2 tilt provides continuous balance and lets the body recline naturally, pivoting at the ankles, knees, and hips. The chair has a 5-star base offered in two design profiles and 3 height-adjustment options. The low-height option has a seat-height range of 14³/₄" to 19"; the standard-height option has a seat-height range of 16" to 20¹/₂"; and the high-height option has a seat-height range of 16³/₄" to 22¹/₄".

Tilt options include a standard tilt, tilt limiter, and tilt limiter and seat angle. The tilt limiter allows the user to set the tilt range to limit the amount of recline. The tilt limiter and seat angle allows the user to set the tilt range and select a 5° forward seat angle.

Back support options include a basic back support version, a standard fixed lumbar version and a user-adjustable lumbar support version. The adjustable lumbar support adjusts 4¹/₂" in height and 1" in depth. All back support options include passive PostureFit at the base of the back, below the beltline, that helps achieve healthier posture and improved lower back comfort.

The chair's Butterfly Back is specified with a Latitude™ fabric color that corresponds to the polymer back shell colors. The applied fabric is on the front side of the backrest and allows flexible support and airflow. Fabric cannot be applied to the chair's AireWeave seat.

Seat options include a 16¹/₄" fixed seat depth or a FlexFront® seat depth that allows the user to adjust the seat depth from 16¹/₄" to 18". Arm choices include no arms, fixed arms, or 4-dimensional adjustable arms that adjust the arms 5¹/₂" vertically, 1¹/₈" horizontally, 2" front-to-back, and pivot the armpads 20° outward and 20° inward.

Notes

To order chair knocked down, specify MRF2. Pricing same as fully assembled chair MRF1.

For information on casters and glides, see Casters and Glides in Appendices.

MicrobeCare™ is an antimicrobial coating that can be applied to a wide variety of Herman Miller Group surfaces to protect products from mold, mildew, algae, and bacteria that cause deterioration, discoloration, odors, and stains.

MicrobeCare™ is a US Environmental Protection Agency (EPA) registered nonpublic health antimicrobial.

MicrobeCare™ is applied to the major touchpoints, including the seat, backrest, arms, armrests, frame and adjustment controls.

Dimensions

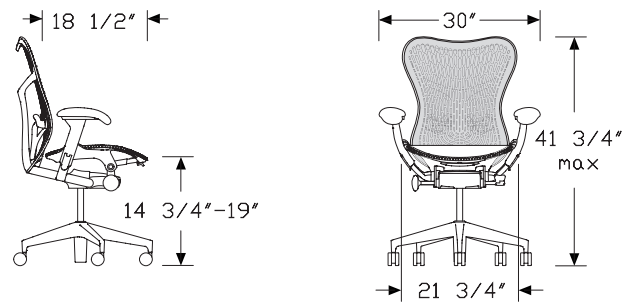

Low-Height Range

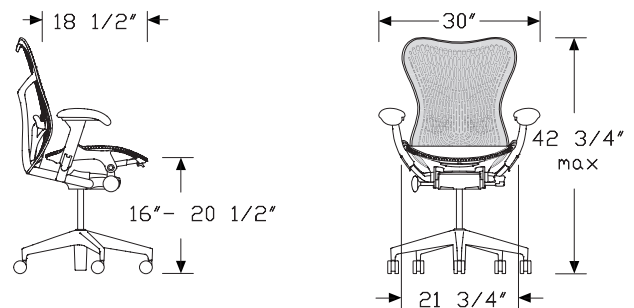

Standard-Height Range

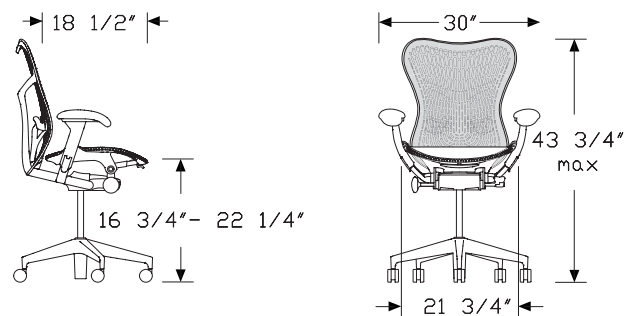

High-Height Range

Specification Information		
Step 1.		
MRF1		
Step 2. Height Adjustment		
1	low-height range	+\$1149
2	standard-height range	+\$1149
3	high-height range	+\$1149
Step 3. Tilt		
1	standard tilt	+\$0
2	tilt limiter	+\$57
3	tilt limiter and seat angle	+\$109
Step 4. Arms		
P	fixed arms	+\$169
N	no arms	+\$0
A	adjustable arms	+\$270
Step 5. Armpad Upholstery		
<i>For no arms (N)</i>		
N	no arms	+\$0
<i>For fixed arms (P) or adjustable arms (A)</i>		
W	nonupholstered armpads	+\$0
Step 6. Seat-Depth Adjustment		
F	fixed seat depth	+\$0
A	FlexFront® adjustable seat depth	+\$95
Step 7. Back		
F	Butterfly™ suspension back	+\$121
P	TriFlex™ polymer back	+\$0
Step 8. Fire Retardancy		
<i>For not fire retardant (*), skip this step.</i>		
<i>For fixed seat depth (F) with Butterfly™ suspension back (F) or TriFlex™ polymer back (P), skip this step.</i>		
	not fire retardant	+\$0
<i>For FlexFront® adjustable seat depth (A) with Butterfly™ suspension back (F) or TriFlex™ polymer back (P)</i>		
	not fire retardant	+\$0

Step 9. Back Support Option		
SZS	basic back support	+\$0
N2	non-adjustable support	+\$45
AJ	adjustable lumbar support	+\$75
Step 10. Base/Frame Finish		
G1	graphite	+\$0
65	fog with studio white frame	+\$75
6K7	silver alloy base with graphite frame	+\$93
6K8	silver alloy base with studio white frame	+\$153
6K9	semi-polished base with graphite frame	+\$300
6KA	semi-polished base with studio white frame	+\$360
MG1	graphite with MicrobeCare™ A	+\$70
M65	fog with studio white frame with MicrobeCare™ A	+\$145
MLG	silver alloy base with graphite frame with MicrobeCare™ A	+\$163
MLW	silver alloy base with studio white frame with MicrobeCare™ A	+\$223
MYG	semi polished base with graphite frame with MicrobeCare™ A	+\$370
MYW	semi polished base with studio white frame with MicrobeCare™ A	+\$430
Step 11. Casters/Glides		
SC8	2½" caster, black yoke, hard floors or carpet with quiet roll technology	+\$50
BB	2½" hard caster, black yoke, carpet only	+\$0
GF	2½" glide, hard floors or carpet	+\$25
C7	2½" caster, black yoke, hard floors or carpet	+\$50
C9	2½" braking caster, black yoke, hard floors or carpet	+\$50
Step 12. Back Finish		
G1	graphite	+\$0
SG	slate grey	+\$30
97	twilight	+\$35
DTR	dark turquoise	+\$35
ZS	lime green	+\$40
BRN	urban orange	+\$45
98	studio white	+\$60

Step 13. Butterfly™ Back Color

See application chart and textiles list for material usage and numbers.
First 2 digits of number indicate material; remaining 2 digits indicate color.

For Butterfly™ suspension back (F) with not fire retardant with graphite (G1)
Price Category 3 +\$0

For Butterfly™ suspension back (F) with not fire retardant with slate grey (SG)
Price Category 3 +\$0

For Butterfly™ suspension back (F) with not fire retardant with dark turquoise (DTR)
Price Category 3 +\$0

For Butterfly™ suspension back (F) with not fire retardant with lime green (ZS)
Price Category 3 +\$0

For Butterfly™ suspension back (F) with not fire retardant with urban orange (BRN)
Price Category 3 +\$0

For Butterfly™ suspension back (F) with not fire retardant with twilight (97)
Price Category 3 +\$0

For Butterfly™ suspension back (F) with not fire retardant
Price Category 3 +\$0

For Butterfly™ suspension back (F) with not fire retardant with studio white (98)
Price Category 3 +\$0

Step 14. Armpad Finish

For fixed arms (P) or adjustable arms (A) with nonupholstered armpads (W)

BK black +\$0
63 fog +\$0

Step 15. AireWeave™ 2 Suspension Material

See application chart and textiles list for fabric usage and numbers.
First 2 digits of number indicate fabric line; remaining digit(s) indicate fabric color.

Price Category 1 +\$0

Mirra® 2 Work Chair, Ready to Assemble

MRF21
MRF22
MRF23



Mirra® 2 Work Chairs

Product Information

Description

This chair has 2 backrest options. The Butterfly Back™ creates an intelligent support structure for the user's entire back. It utilizes a new method for merging a fabric layer with flexible polymer shell. The TriFlex™ 2 back is 100% polymer, no fabric, with a similar design that offers flexible and continuous support. These options, combined with the new loop spine design and passive PostureFit® sacral support allow for a new level of personal contouring and micro-motion support, with the Butterfly Back offering the highest level of comfort. The AireWeave™ seat-suspension material is lightweight and breathable and evenly distributes the user's weight over the seat of the chair. The chair's Harmonic™ 2 tilt provides continuous balance and lets the body recline naturally, pivoting at the ankles, knees, and hips. The chair has a 5-star base offered in two design profiles and 3 height-adjustment options. The low-height option has a seat-height range of 14³/₄" to 19"; the standard-height option has a seat-height range of 16" to 20¹/₂"; and the high-height option has a seat-height range of 16³/₄" to 22¹/₄".

Tilt options include a standard tilt, tilt limiter, and tilt limiter and seat angle. The tilt limiter allows the user to set the tilt range to limit the amount of recline. The tilt limiter and seat angle allows the user to set the tilt range and select a 5° forward seat angle.

Back support options include a basic back support version, a standard fixed lumbar version and a user-adjustable lumbar support version. The adjustable lumbar support adjusts 4¹/₂" in height and 1" in depth. All back support options include passive PostureFit at the base of the back, below the beltline, that helps achieve healthier posture and improved lower back comfort.

The chair's Butterfly Back is specified with a Latitude™ fabric color that corresponds to the polymer back shell colors. The applied fabric is on the front side of the backrest and allows flexible support and airflow. Fabric cannot be applied to the chair's AireWeave seat.

Seat options include a 16¹/₄" fixed seat depth or a FlexFront® seat depth that allows the user to adjust the seat depth from 16¹/₄" to 18". Arm choices include no arms, fixed arms, or 4-dimensional adjustable arms that adjust the arms 5¹/₂" vertically, 1¹/₈" horizontally, 2" front-to-back, and pivot the armpads 20° outward and 20° inward.

Notes

To order chair fully assembled, specify MRF1. Pricing same as knocked down chair MRF2.

For information on casters and glides, see Casters and Glides in Appendices.

MicrobeCare™ is an antimicrobial coating that can be applied to a wide variety of Herman Miller Group surfaces to protect products from mold, mildew, algae, and bacteria that cause deterioration, discoloration, odors, and stains.

MicrobeCare™ is a US Environmental Protection Agency (EPA) registered nonpublic health antimicrobial.

MicrobeCare™ is applied to the major touchpoints, including the seat, backrest, arms, armrests, frame and adjustment controls.

Dimensions

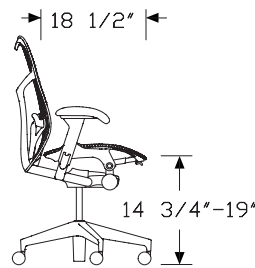

Low-Height Range

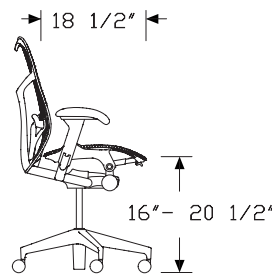
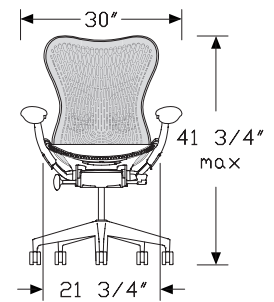

Standard-Height Range

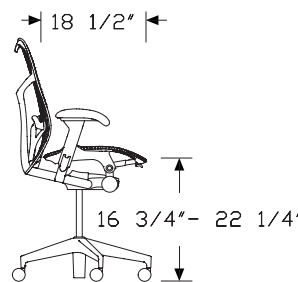
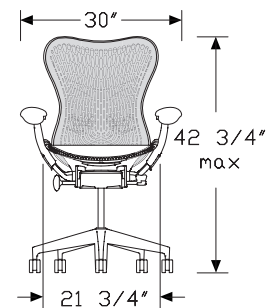

High-Height Range

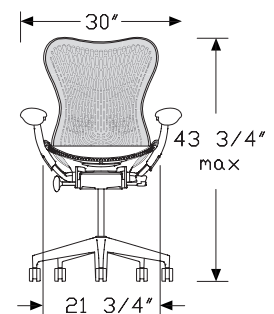

Mirra® 2 Work Chair, Ready to Assemble *continued*

Specification Information

Step 1.

MRF2

Step 2. Height Adjustment

1	low-height range	+\$1149
2	standard-height range	+\$1149
3	high-height range	+\$1149

Step 3. Tilt

1	standard tilt	+\$0
2	tilt limiter	+\$57
3	tilt limiter and seat angle	+\$109

Step 4. Arms

P	fixed arms	+\$169
N	no arms	+\$0
A	adjustable arms	+\$270

Step 5. Armpad Upholstery

For no arms (N)

N	no arms	+\$0
----------	---------	------

For fixed arms (P) or adjustable arms (A)

W	nonupholstered armpads	+\$0
----------	------------------------	------

Step 6. Seat-Depth Adjustment

F	fixed seat depth	+\$0
A	FlexFront® adjustable seat depth	+\$95

Step 7. Back

F	Butterfly™ suspension back	+\$121
P	TriFlex™ polymer back	+\$0

Step 8. Fire Retardancy

For not fire retardant (), skip this step.*

For FlexFront® adjustable seat depth (A) with Butterfly™ suspension back (F) or TriFlex™ polymer back (P), skip this step.

	not fire retardant	+\$0
--	--------------------	------

For fixed seat depth (F) with Butterfly™ suspension back (F) or TriFlex™ polymer back (P)

	not fire retardant	+\$0
--	--------------------	------

Step 9. Back Support Option

SZS	basic back support	+\$0
N2	non-adjustable support	+\$45
AJ	adjustable lumbar support	+\$75

Step 10. Base/Frame Finish

G1	graphite	+\$0
65	fog with studio white frame	+\$75
6K7	silver alloy base with graphite frame	+\$93
6K8	silver alloy base with studio white frame	+\$153
6K9	semi-polished base with graphite frame	+\$300
6KA	semi-polished base with studio white frame	+\$360
MG1	graphite with MicrobeCare™ A	+\$70
M65	fog with studio white frame with MicrobeCare™ A	+\$145
MLG	silver alloy base with graphite frame with MicrobeCare™ A	+\$163
MLW	silver alloy base with studio white frame with MicrobeCare™ A	+\$223
MYG	semi polished base with graphite frame with MicrobeCare™ A	+\$370
MYW	semi polished base with studio white frame with MicrobeCare™ A	+\$430

Step 11. Casters/Glides

SC8	2½" caster, black yoke, hard floors or carpet with quiet roll technology	+\$50
BB	2½" hard caster, black yoke, carpet only	+\$0
GF	2½" glide, hard floors or carpet	+\$25
C7	2½" caster, black yoke, hard floors or carpet	+\$50
C9	2½" braking caster, black yoke, hard floors or carpet	+\$50

Step 12. Back Finish

G1	graphite	+\$0
SG	slate grey	+\$30
97	twilight	+\$35
DTR	dark turquoise	+\$35
ZS	lime green	+\$40
BRN	urban orange	+\$45
98	studio white	+\$60

Mirra® 2 Work Chair, Ready to Assemble *continued*

Step 13. Butterfly™ Back Color
 See application chart and textiles list for material usage and numbers.
 First 2 digits of number indicate material; remaining 2 digits indicate color.

For Butterfly™ suspension back (F) with not fire retardant with graphite (G1)
 Price Category 3 +\$0

For Butterfly™ suspension back (F) with not fire retardant with slate grey (SG)
 Price Category 3 +\$0

For Butterfly™ suspension back (F) with not fire retardant with dark turquoise (DTR)
 Price Category 3 +\$0

For Butterfly™ suspension back (F) with not fire retardant with lime green (ZS)
 Price Category 3 +\$0

For Butterfly™ suspension back (F) with not fire retardant with urban orange (BRN)
 Price Category 3 +\$0

For Butterfly™ suspension back (F) with not fire retardant with twilight (97)
 Price Category 3 +\$0

For Butterfly™ suspension back (F) with not fire retardant
 Price Category 3 +\$0

For Butterfly™ suspension back (F) with not fire retardant with studio white (98)
 Price Category 3 +\$0

Step 14. Armpad Finish
 For fixed arms (P) or adjustable arms (A) with nonupholstered armpads (W)

BK	black	+\$0
63	fog	+\$0

Step 15. AireWeave™ 2 Suspension Material
 See application chart and textiles list for fabric usage and numbers.
 First 2 digits of number indicate fabric line; remaining digit(s) indicate fabric color.
 Price Category 1 +\$0

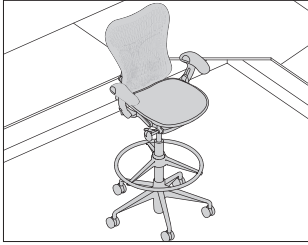

Product Information

Description

This stool has a 5-star base and 1 height cylinder with a seat-height range of 23 1/2" to 33 1/2".

The stool has 2 backrest options. The Butterfly Back™ creates an intelligent support structure for the user's entire back. It utilizes a new method for merging a fabric layer with flexible polymer shell. The TriFlex™ 2 back is 100% polymer, no fabric, with a similar design that offers flexible and continuous support. These options, combined with the loop spine design and passive PostureFit® sacral support allow for a new level of personal contouring and micro-motion support, with the Butterfly Back offering the highest level of comfort. The AireWeave™ seat-suspension material is lightweight and breathable and evenly distributes the user's weight over the seat of the stool. The stool's Harmonic™ 2 tilt provides continuous balance and lets the body recline naturally, pivoting at the ankles, knees, and hips.

Tilt options include a tilt limiter, and tilt limiter and seat angle. The tilt limiter allows the user to set the tilt range to limit the amount of recline. The tilt limiter and seat angle allows the user to set the tilt range and select a 5° forward seat angle.

Back support options include a basic back support version, a standard fixed lumbar version and a user-adjustable lumbar support version. The adjustable lumbar support adjusts 4 1/2" in height and 1" in depth. All back support options include passive PostureFit at the base of the back, below the beltline, that helps achieve healthier posture and improved lower back comfort.

The stool's Butterfly Back is specified with a Latitude™ fabric color that corresponds to the polymer back shell colors. The applied fabric is on the front side of the backrest and allows flexible support and airflow. Fabric cannot be applied to the stool's AireWeave seat.

Seat options include a 16 1/4" fixed seat depth or a FlexFront® seat depth that allows the user to adjust the seat depth from 16 1/4" to 18". Arm choices include no arms, fixed arms, or 4-dimensional adjustable arms that adjust the arms 5 1/2" vertically, 1 1/8" horizontally, 2" front-to-back, and pivot the armpads 20° outward and 20° inward.

Notes

20"-diameter footrest adjusts 4 1/2" in height.

Footrest available in trivalent chrome; column and ring support are black.

For information on casters and glides, see Casters and Glides in Appendices.

MicrobeCare™ is an antimicrobial coating that can be applied to a wide variety of Herman Miller Group surfaces to protect products from mold, mildew, algae, and bacteria that cause deterioration, discoloration, odors, and stains.

MicrobeCare™ is a US Environmental Protection Agency (EPA) registered nonpublic health antimicrobial.

MicrobeCare™ is applied to the major touchpoints, including the seat, backrest, arms, armrests, frame and adjustment controls.

Dimensions

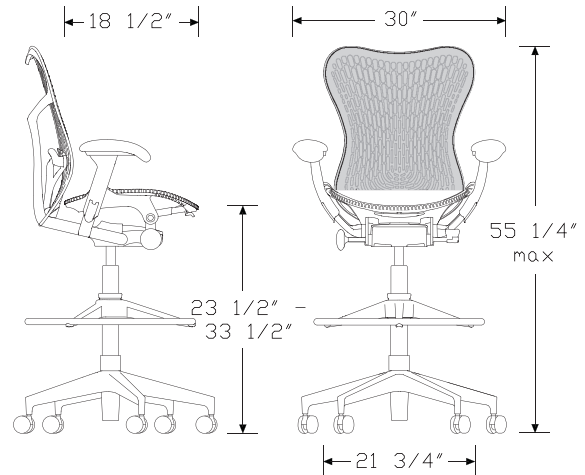

Specification Information		
Step 1.		
MRF7		
Step 2. Height Adjustment		
5	stool high height range	+\$1547
Step 3. Tilt		
2	tilt limiter	+\$0
3	tilt limiter and seat angle	+\$57
Step 4. Arms		
P	fixed arms	+\$169
N	no arms	+\$0
A	adjustable arms	+\$270
Step 5. Armpad Upholstery		
<i>For no arms (N)</i>		
N	no arms	+\$0
<i>For fixed arms (P) or adjustable arms (A)</i>		
W	nonupholstered armpads	+\$0
Step 6. Seat-Depth Adjustment		
F	fixed seat depth	+\$0
A	FlexFront® adjustable seat depth	+\$95
Step 7. Back		
F	Butterfly™ suspension back	+\$121
P	TriFlex™ polymer back	+\$0
Step 8. Fire Retardancy		
<i>For not fire retardant (*), skip this step.</i>		
<i>For fixed seat depth (F) with Butterfly™ suspension back (F) or TriFlex™ polymer back (P), skip this step.</i>		
	not fire retardant	+\$0
<i>For FlexFront® adjustable seat depth (A) with Butterfly™ suspension back (F) or TriFlex™ polymer back (P)</i>		
	not fire retardant	+\$0
Step 9. Back Support Option		
SZS	basic back support	+\$0
N2	non-adjustable support	+\$45
AJ	adjustable lumbar support	+\$75

Step 10. Base/Frame Finish		
G1	graphite	+\$0
65	fog with studio white frame	+\$75
6K7	silver alloy base with graphite frame	+\$93
6K8	silver alloy base with studio white frame	+\$153
6K9	semi-polished base with graphite frame	+\$300
6KA	semi-polished base with studio white frame	+\$360
MG1	graphite with MicrobeCare™ A	+\$70
M65	fog with studio white frame with MicrobeCare™ A	+\$145
MLG	silver alloy base with graphite frame with MicrobeCare™ A	+\$163
MLW	silver alloy base with studio white frame with MicrobeCare™ A	+\$223
MYG	semi polished base with graphite frame with MicrobeCare™ A	+\$370
MYW	semi polished base with studio white frame with MicrobeCare™ A	+\$430
Step 11. Casters/Glides		
SC8	2½" caster, black yoke, hard floors or carpet with quiet roll technology	+\$50
BB	2½" hard caster, black yoke, carpet only	+\$0
GF	2½" glide, hard floors or carpet	+\$25
C7	2½" caster, black yoke, hard floors or carpet	+\$50
C9	2½" braking caster, black yoke, hard floors or carpet	+\$50
Step 12. Back Finish		
G1	graphite	+\$0
SG	slate grey	+\$30
97	twilight	+\$35
DTR	dark turquoise	+\$35
ZS	lime green	+\$40
BRN	urban orange	+\$45
98	studio white	+\$60
Step 13. Butterfly™ Back Color		
<i>See application chart and textiles list for material usage and numbers. First 2 digits of number indicate material; remaining 2 digits indicate color.</i>		
<i>For Butterfly™ suspension back (F) with not fire retardant with graphite (G1)</i>		
	Price Category 3	+\$0
<i>For Butterfly™ suspension back (F) with not fire retardant with slate grey (SG)</i>		
	Price Category 3	+\$0

For Butterfly™ suspension back (F) with not fire retardant with dark turquoise (DTR)
 Price Category 3 +\$0

For Butterfly™ suspension back (F) with not fire retardant with lime green (ZS)
 Price Category 3 +\$0

For Butterfly™ suspension back (F) with not fire retardant with urban orange (BRN)
 Price Category 3 +\$0

For Butterfly™ suspension back (F) with not fire retardant with twilight (97)
 Price Category 3 +\$0

For Butterfly™ suspension back (F) with not fire retardant
 Price Category 3 +\$0

For Butterfly™ suspension back (F) with not fire retardant with studio white (98)
 Price Category 3 +\$0

Step 14. Armpad Finish
 For fixed arms (P) or adjustable arms (A) with nonupholstered armpads (W)
BK black +\$0
63 fog +\$0

Step 15. AireWeave™ 2 Suspension Material
 See application chart and textiles list for fabric usage and numbers.
 First 2 digits of number indicate fabric line; remaining digit(s) indicate fabric color.
 Price Category 1 +\$0

Upholstered Back Kit

MRF910

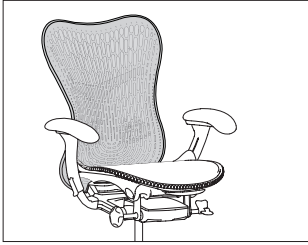

Mirra® 2 Accessories

Product Information

Description

This back replaces an existing Butterfly Back™ on a Mirra® 2 work chair or stool. The back utilizes a new method for merging a fabric layer with flexible polymer shell. The specially bonded back surface allows flexible support and airflow.

Notes

Specify Butterfly Back kit frame finish to match Mirra 2 work chair or stool frame finish.

Existing Mirra 2 chair or stool lumbar strap or fixed back loop finish should match molded back finish. To change lumbar strap finish for an existing chair or stool, order adjustable lumbar kit (MRF905A) separately.

Specification Information

Step 1.

MRF910

Step 2. Fire Retardancy

For not fire retardant (), skip this step.*

not fire retardant

Prices for Steps 1-2.

MRF910 \$191

Step 3. Frame Finish

98	studio white <input type="checkbox"/>	+\$0
G1	graphite <input type="checkbox"/>	+\$0

Step 4. Back Finish

97	twilight <input type="checkbox"/>	+\$0
98	studio white <input type="checkbox"/>	+\$0
BRN	urban orange <input type="checkbox"/>	+\$0
DTR	dark turquoise <input type="checkbox"/>	+\$0
G1	graphite <input type="checkbox"/>	+\$0
SG	slate grey <input type="checkbox"/>	+\$0
ZS	lime green <input type="checkbox"/>	+\$0

Step 5. Butterfly™ Back Color

See application chart and textiles list for fabric usage and numbers.

First 2 digits of number indicate fabric line; remaining digit(s) indicate fabric color.

For not fire retardant with graphite (G1)

Price Category 3 \$+\$0

For not fire retardant with slate grey (SG)

Price Category 3 \$+\$0

For not fire retardant with dark turquoise (DTR)

Price Category 3 \$+\$0

For not fire retardant with lime green (ZS)

Price Category 3 \$+\$0

For not fire retardant with urban orange (BRN)

Price Category 3 \$+\$0

For not fire retardant with twilight (97)

Price Category 3 \$+\$0

Price Category 3 \$+\$0

Upholstered Back Kit *continued*

For not fire retardant with studio white (98)

Price Category 3 +\$0

Lumbar Kit

MRF905

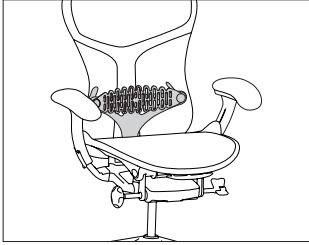

Product Information

Description

This adjustable lumbar support fits into the back of a Mirra® 2 work chair or stool. It adjusts 4½" in height and 1" in depth.

Notes

Lumbar kit's support bow finish matches Mirra 2 chair or stool frame finish. Lumbar kit's lumbar strap finish matches Mirra 2 chair or stool molded Butterfly Back™ finish.

Specification Information

Step 1.

MRF905A A \$114

Step 2. Support Bow Finish

98 studio white A +\$0
G1 graphite A +\$0

Step 3. Lumbar Strap Finish

97 twilight A +\$0
98 studio white A +\$0
BRN urban orange A +\$0
DTR dark turquoise A +\$0
G1 graphite A +\$0
SG slate grey A +\$0
ZK cappuccino A +\$0
ZS lime green A +\$0

Arm Kit

MRF900

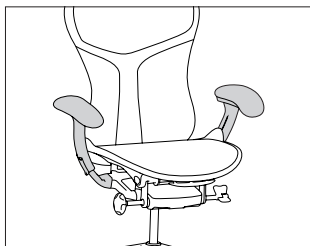

Product Information

Description

These arms retrofit to a Mirra® 2 work chair or stool. They adjust 5½" vertically, 1⅛" horizontally, 2" front-to-back, and pivot the armpads 20° outward and 20° inward.

Specification Information

Step 1.

MRF900 A

Step 2. Arms

A adjustable arms

Step 3. Armpad Upholstery

W nonupholstered armpads A

Prices for Steps 1-3.

	W
MRF900 A	\$264

Step 4. Base/Frame Finish

G1	graphite A	+\$0
65	fog with studio white frame A	+\$19
6K7	silver alloy base with graphite frame A	+\$25
6K8	silver alloy base with studio white frame A	+\$35
6K9	semi-polished base with graphite frame A	+\$35
6KA	semi-polished base with studio white frame A	+\$45

Step 5. Armpad Finish

63	fog	+\$0
BK	black	+\$0

Jacket Hanger

MRF920

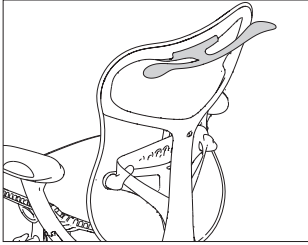

Product Information

Description
 This jacket hanger allows the user to maintain good posture with full contact with the back of the chair while hanging short jackets.

Notes
 Jacket hanger is designed for Mirra® 2 work chairs and stools.
 Hanger is designed to support garments weighing up to 4½ pounds.
 No tools required for assembly.

Dimensions

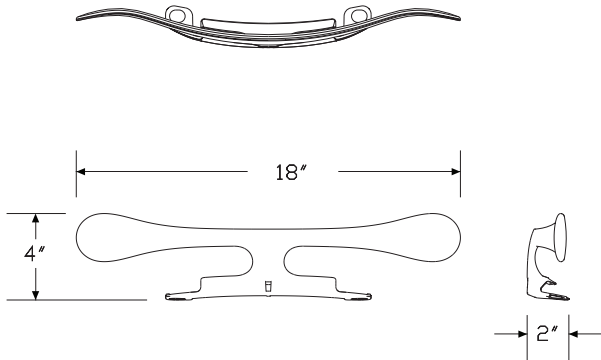

Specification Information

Step 1.		
MRF920	A	\$36
Step 2. Finish		
98	studio white A	+\$0
G1	graphite A	+\$0

Mirra® 2 Accessories

Index by Product Name

Mirra® 2 Chairs	
Arm Kit	page(s) 17
Jacket Hanger	18
Lumbar Kit	16
Mirra® 2 Stool	11
Mirra® 2 Work Chair	5
Mirra® 2 Work Chair, Ready to Assemble	8
Upholstered Back Kit	14



Index by Product Number



MRF11	Mirra® 2 Work Chair	page(s) 5
MRF12		
MRF13		
MRF21	Mirra® 2 Work Chair, Ready to Assemble	8
MRF22		
MRF23		
MRF75	Mirra® 2 Stool	11
MRF900	Arm Kit	17
MRF905	Lumbar Kit	16
MRF910	Upholstered Back Kit	14
MRF920	Jacket Hanger	18



20-Day or Less/Assigned Lead-Time Order Information

20-Day or Less and Assigned Lead-Time Programs

20-day or less and assigned lead-time products are designed for established Herman Miller dealers with pre-approved credit.

Products are distributed from multiple manufacturing facilities across the United States. All products and options not designated by an Assigned Lead-Time icon  will ship in 20 business days or less after being acknowledged by Herman Miller. Products and options designated by an  are on the assigned lead-time program and will ship in 20 days, less than 20 days, or more than 20 days from order acknowledgement.

Ordering Procedure

Please place orders through Order Manager. If this is not available to you, place orders through mail or fax. Verbal purchase orders will not be accepted.

Order Entry fax number for Meridian®

Filing and Storage: (616) 846 9236.

Order Entry fax number for all other products:

(616) 654 3085.

For more information, contact your Customer Care representative at:
(866) 854 3048 ext 3400.

Shipments and Delivery

Per Herman Miller Terms and Conditions.

Changes and Cancellation

Per Herman Miller Terms and Conditions.



Casters and Glides

▲	WARNING	▲
Depending on the floor surface, chair may unexpectedly roll away from user when entering or exiting the chair, possibly leading to unexpected injury. Please refer to descriptions of floor types when selecting casters.		

32 Caster

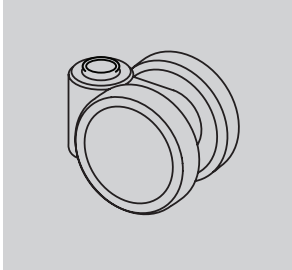

1⁷/₈-inch-diameter hard double-wheel caster; black nylon wheels and yoke; for use on carpet only

Applicable on:
Keyn Chairs
Sayl® Chairs

BB Caster

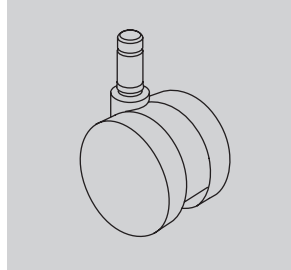

2¹/₂-inch-diameter hard double-wheel caster; black nylon wheels and yoke; for use on carpet only

Applicable on:
Asari Chair by Herman Miller™
New Aeron® Chairs
Caper® Chairs
Embody® Chairs
Equa 2® Chairs
Ergon 3® Chairs
Lino™ Chairs
Sayl Chairs
Mirra® 2 Chairs, Verus™ Chairs

BSC Caster

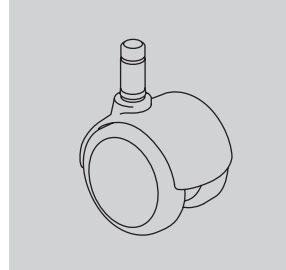

2-inch-diameter double-wheel caster; black nylon wheels and hood; soft polyurethane tread; for use on hard floors or carpet

Applicable on:
Eames® Aluminum Group
Eames Executive Chairs
Eames Soft Pad Group
Eames Task Chairs

C9 Caster

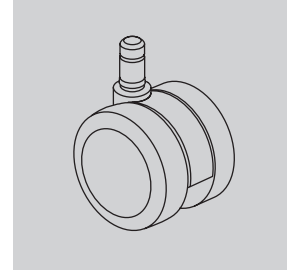

2¹/₂-inch-diameter double-wheel caster; black nylon wheels and yoke; soft polyurethane tread; internal brake; for use on hard floors or carpet

Applicable on:
Caper Chairs
Embody Chairs
Equa 2 Chairs
Ergon 3 Chairs
Keyn Chairs
Lino Chairs
Mirra 2 Chairs
Sayl Chairs
Setu® Chairs
Verus Chairs

49 Caster

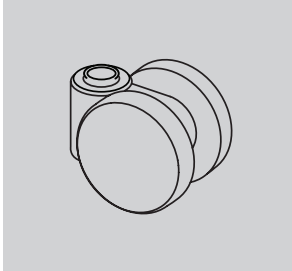

1⁷/₈-inch-diameter soft double-wheel caster; black nylon wheels and yoke; for use on hard floors or carpet

Applicable on:
Keyn Chairs
Sayl Chairs

BKS Caster

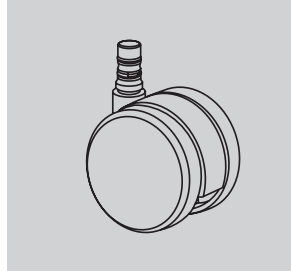

2¹/₂-inch-diameter hard double-wheel caster; black yoke; quiet roll technology; for use on carpet only

Applicable on:
Cosm™ Chairs

C7 Caster

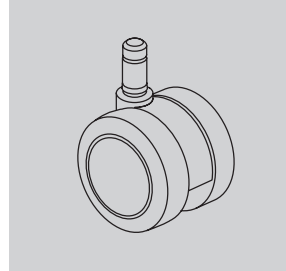

2¹/₂-inch-diameter double-wheel caster; black nylon wheels and yoke; soft polyurethane tread; for use on hard floors or carpet

Applicable on:
Asari Chair by Herman Miller™
New Aeron Chairs
Caper Chairs
Embody Chairs
Equa 2 Chairs
Ergon 3 Chairs
Lino Chairs
Mirra 2 Chairs
Sayl Chairs
Verus Chairs

CSQ Caster

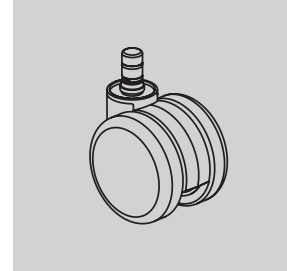

2¹/₂-inch-diameter double-wheel caster; color-matched nylon wheels and yoke; soft polyurethane tread; for use on hard floors or carpet

Applicable on:
Zeph™ Chairs

Casters and Glides

continued

DC1 Caster

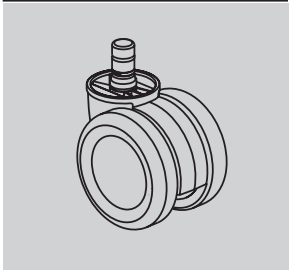

2¹/₂-inch-diameter double-wheel braking caster; black nylon wheels and yoke; for use on hard floors or carpet; quiet roll technology

Applicable on:

New Aeron Chairs

H9 Caster

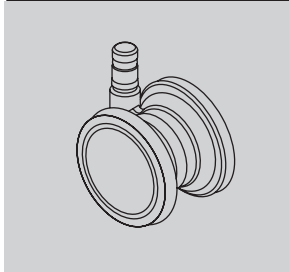

2¹/₂-inch-diameter double-wheel caster; clear polycarbonate wheels; nylon yoke; soft polyurethane tread; for use on carpet only

Applicable on:

Embody Chairs
Keyn Chairs

HW Caster

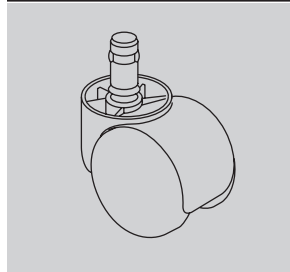

2-inch-diameter double-wheel caster; black nylon wheels and hood; for use on carpet only

Applicable on:

Limerick® Cart

O2 Caster

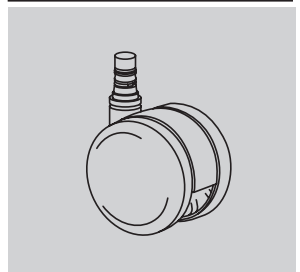

2¹/₂-inch-diameter double-wheel caster; nylon wheels and yoke; soft polyurethane tread; quiet roll technology; for use on hard floors or carpet

Applicable on:

Cosm Chairs

DS Caster

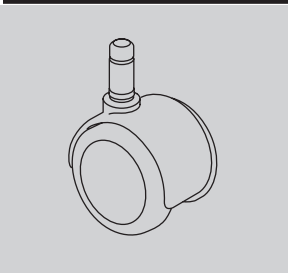

2-inch-diameter soft double-wheel braking caster; black nylon wheels and hood; for use on hard floors only

Applicable on:

Aside® Chairs
Caper Chairs

HCC Caster

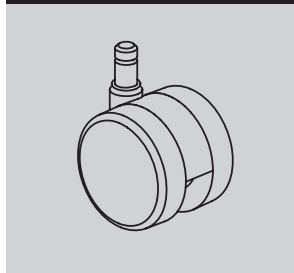

2¹/₂-inch-diameter double-wheel low roll resistance caster; black yoke; for use on hard floors or carpet

Applicable on:

Keyn Chairs
Setu Chairs

MD Caster

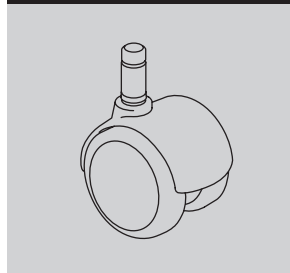

2-inch-diameter double-wheel caster; black nylon wheels with integral chrome hood; soft polyurethane tread; for use on hard floors or carpet

Applicable on:

Eames® Aluminum Group
Eames Executive Chairs
Eames Soft Pad Group
Eames Task Chairs

OC Caster



2¹/₂-inch-diameter double-wheel medium roll-resistant caster; black nylon wheels and yoke; soft polyurethane tread; for use on hard floors or carpet; quiet roll technology

Applicable on:

Cosm Chairs
Keyn Chairs
Setu Chairs

Casters and Glides

continued

SC8 Caster

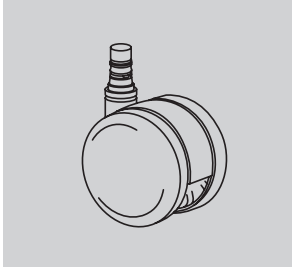

2¹/₂-inch-diameter double-wheel caster; black nylon wheels and yoke; soft polyurethane tread; quiet roll technology; for use on hard floors or carpet

Applicable on:
Cosm Chairs
Lino Chairs
Mirra 2 Chairs
Verus Chairs

U4 Caster

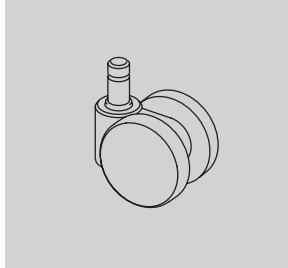

1⁷/₈-inch-diameter hard double-wheel caster; black nylon wheels and yoke; for use on carpet only

Applicable on:
Aside Chairs
Verus Chairs

UD Caster

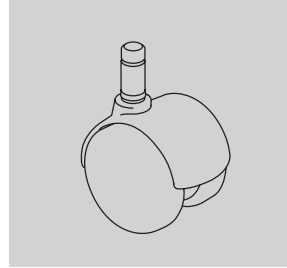

2-inch-diameter hard double-wheel caster; black nylon wheels with painted hood; for use on carpet only

Applicable on:
Eames® Aluminum Group
Eames Executive Chairs
Eames Soft Pad Group
Eames Task Chairs

16 Glide

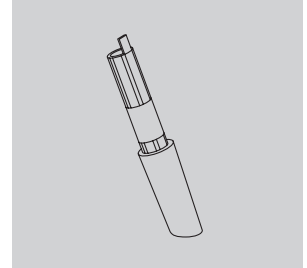

(Front glide shown)
2¹/₈-inch-high glide; black or fog acetal; for use on carpet only

Applicable on:
Sayl Chairs

SW Caster

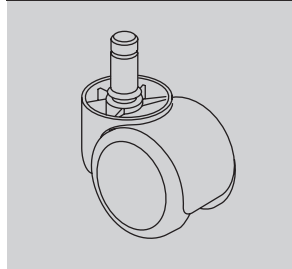

2-inch-diameter soft double-wheel caster; black nylon wheels and hood; for use on hard floors only

Applicable on:
Limerick Cart

U5 Caster

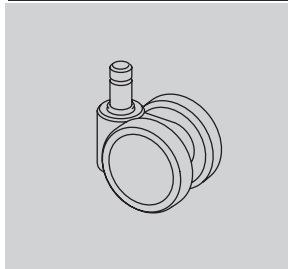

1⁷/₈-inch-diameter soft double-wheel caster; black nylon wheels and yoke; for use on hard floors or carpet

Applicable on:
Aside Chairs
Caper Chairs
Verus Chairs

VD Caster

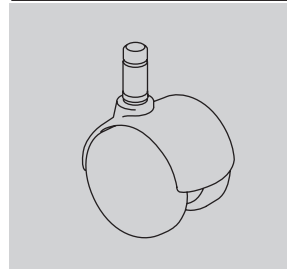

2-inch-diameter hard double-wheel caster; black nylon wheels with integral chrome hood; for use on carpet only

Applicable on:
Eames Aluminum Group
Eames Executive Chairs
Eames Soft Pad Group
Eames Task Chairs

69 Glide

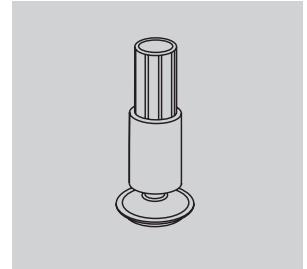

(Front glide shown)
2¹/₈-inch-high glide; black glass-filled nylon stem; steel-plated swivel foot with Floor Saver Glide™ insert; for use on hard floors only

Applicable on:
Sayl Chairs

Casters and Glides

continued

AGL Glide

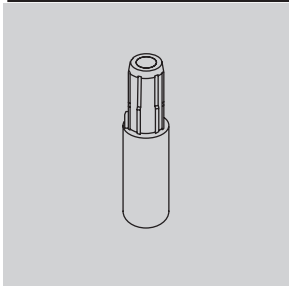

2¹/₄-inch-high glide; black or white nylon stem; for use on carpet only

Applicable on:
Keyn Chairs

G4 Glide

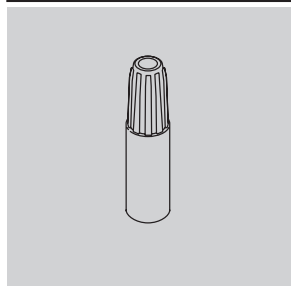

1⁷/₈-inch-high glide; black acetal; for use on carpet only

Applicable on:
Verus Chairs

GF Glide

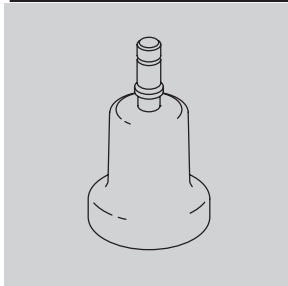

2¹/₂-inch-high glide; black nylon; for use on hard floors or carpet

Applicable on:
New Aeron Chairs
Caper Chairs
Cosm Chairs
Equa 2 Chairs
Ergon 3 Chairs
Lino Chairs
Mirra 2 Chairs
Sayl Chairs
Verus Chairs

GL Glide

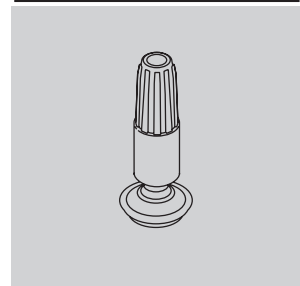

1⁷/₈-inch-high glide; black nylon stem; steel-plated swivel foot with Floor Saver Glide™ insert; for use on hard floors only

Applicable on:
Verus chairs

FSG Glide

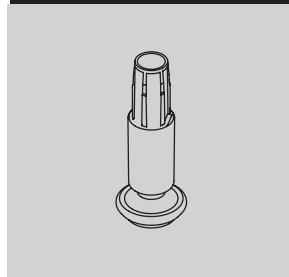

2¹/₄-inch-high glide; black or white nylon stem; steel-plated swivel foot with Floor Saver Glide™ insert; for use on hard floors only

Applicable on:
Keyn Chairs

GD Glide

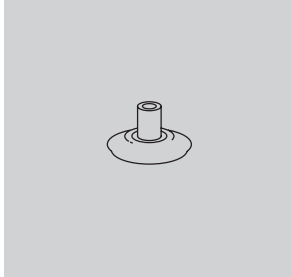

1¹/₂-inch-diameter glide; 1/2 inch in height; black nylon; for use on hard floors or carpet

Applicable on:
Eames Aluminum Group
Eames Executive Chairs
Eames Soft Pad Group
Eames Task Chairs

GG Glide

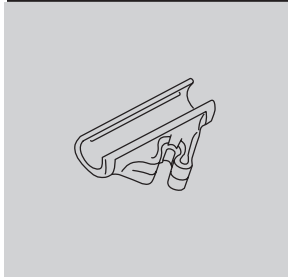

1/2-inch-high ganging glide; clear polycarbonate; for use on hard floors or carpet

Applicable on:
Limerick Chairs
Pronta Stacking Chairs

GLN Glide

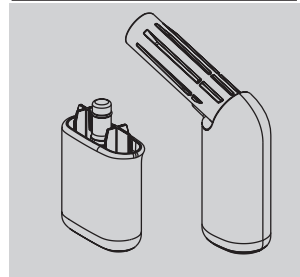

Acetal glide; for use on carpet only

Applicable on:
Fuld Nesting Chair

Casters and Glides

continued



HG Glide
1/2-inch-high glide; black nylon glide with stainless-steel insert; for use on hard floors or carpet

Applicable on:
Aside Chairs



SG Glide (for Aside)
1/2-inch-high glide; black nylon; for use on carpet only

Applicable on:
Aside Chairs

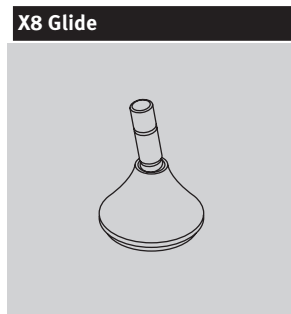

X8 Glide
Glide; low profile; for use on hard floors or carpet

Applicable on:
Setu Chairs



Y7 Glide
1 7/8-inch-high glide; black acetal; for use on carpet only

Applicable on:
Caper Chairs

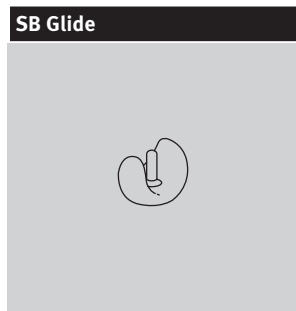

SB Glide
1/4-inch-high, 1-inch diameter glide; thermoplastic CAP material (G1 base has black glides; XT base has clear glides); for use on hard floors or carpet

Applicable on:
Equa 2 Chairs



SG Glide (for Limerick)
1/2-inch-high glide; clear polycarbonate; for use on hard floors or carpet

Applicable on:
Limerick Chairs
Pronta Stacking Chairs

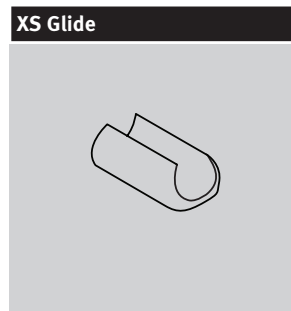

XS Glide
1/8-inch-high glide; polycarbonate in black, fog, clear, and studio white finishes; for use on hard floors or carpet

Applicable on:
Sayl Chairs



YX Glide
1 7/8-inch-high glide; black nylon stem; steel-plated swivel foot with Floor Saver Glide™ insert; for use on hard floors only

Applicable on:
Caper Chairs



Fire Retardancy — Seating

Fire Retardancy

Fire-retardant chairs manufactured in approved fabrics (FR) meet California TB 133 requirements.

All foam and textiles on HermanMiller seating products comply with California TB 117-2013.

State of California
Bureau of Home Furnishings,
Technical Bulletin 133

State of California
Bureau of Home Furnishings,
Technical Bulletin 117-2013

8Z Pellicle		•
Ace		•
AireWeave™ 2		•
Aristo		•
Balance		•
Bento		•
Bingo		•
Crepe		•
Crossing		•
Cygnus™	FR	•
Dex		•
Dialogue		•
Duo		•
Epic		•
Fish Net		•
Flexnet™	FR	•
Gem		•
Hopsak		•
Intercept		•
InterWeave		•
Latitude™		•
Leather		•
Loom		•
Lyris 2™		•
Marvel		•
Medley		•
Mercer		•
Moiré		•
Monologue		•
Noble		•
Pins and Needles		•
Plateau		•
Quilty		•
Rhythm		•
Rivet		•
Sequel		•
Spools		•
Stitches		•
Strata		•
String Plaid		•
Tailored		•
Twist		•
Well Suited		•
Whisper		•

• Fabric meets California TB 117-2013 code requirements.

FR To meet California TB 133 code requirements, fabrics must be applied to approved chairs identified with FR product numbers.



Proprietary Textiles Application Chart — Seating

• Available

[A] Assigned lead-time textile.

[N] Non-woven textile.

See following page for exception notes.

Price Category 1

	Aeron® Chairs	Cosm™ Chairs	Mirra® 2 Chairs/Stools	Embody® Chairs	Fuld Nesting Chairs	Sayl® Work Chairs/Stools	Sayl Side Chairs	Setu® Chairs/Stools	Zeph™ Chairs	Verus™ Work Chairs/Stools Back	Verus Work Chairs/Stools Seat	Verus Side Chairs Back	Verus Side Chairs Seat	Verus Plus Chairs	Aside® Chairs	Caper® Chairs/Stools	Lino™ Chairs Back	Lino Chairs Seat	OE1 Storage Trolley Cushion Top	Public Office Landscape® Back	Public Office Landscape Seat	Plex® Lounge Furniture	Swoop™ Lounge Seating - Fully Upholstered	Swoop Lounge Seating - Plywood	Valor™ Seating	Eames® Tandem Sling Seating	Cushion Tops	Workspaces	
COM Customer's Own Material [A]						1	1			1	1	1	1	1	1			1	1		1	1	1	1	1	1	1	1	1
231__ 8Z Pellicle®	•																												
1A7__ AireWeave™ 2			•																										
8T__ Crossing								•							•				•				•	•			•	•	
3DE__ Dex						•	•	•		•	•	•	•	•	•				•		•	19	•		•		•	•	
4RM__ Duo																	•												
6V__ Flexnet™																•													
95__ Gem								•							•				•				•	•			•	•	
845__ Intercept			•																										
365__ Interweave 2										•		•																	
4W__ Lyris 2™								•																					
1MN__ Monologue						24	22	•		•	•	•						•	•		•	•	•	•	•	•	•	•	
5H2__ Ripple 3D Knit									•																				
5H1__ Splash 3D Knit									•																				
4SC__ Scatter						•	•	•		•	•	•	•	•	•			•	•		•	•	•	•			•	•	
3DN__ Scribe						21	22	•		•		•	•	•	•			•	•		•				•		•	•	
3DK__ Stretch Knit [A]						21																							
235__ Tailored						•	•	•		•	•	•	•		•			•		•	23				•		7	•	
9NK__ Tuck 3D Knit					•																								
1WS__ Whisper						24	•	•		•	•	•	•	•	•			•	•		•	•	•	•	•	•	•	•	

Price Category 2

3AR__ Aristo						•	•	•		•	•	•	•	•	•			•	•	•	•	•	•	•	•	•	•	•
92__ Crepe						•	•	•		•	•	•	•	•	•			•	•	•	•	•	•	•	•	•	•	•
3EP__ Epic						•	•			•	•	•	•	•	•			•	•	•	•	•	•	•	•	•	•	•
1LM__ Loom						•	•			•	•	•	•	•	•			•	•	•	•	•	•	•	•	•	•	•
1MV__ Marvel [N]						21	22	•										•							•		•	•
1HA__ Medley				•		•	22			•	•	•	•	•	•			•	•	•	•	•	•	•	•	•	•	•
4ME__ Mellow						•	22	•		•	•	•	•	•	•			•	•	•	•	•	•	•	•	•	•	•
30__ Rhythm					23	•	•			•	•	•	•	•	•			•	•	•	•	•	•	•	•	•	•	•
3SL__ Sequel [N]						•	•	•		•	•	•	•	•	•	8		•	•	•	•	•	•	•	•	•	•	•
4TE__ Terra						•	22			•	•	•	•	•	•			•	•	•	•	•	•	•	•	•	•	•
8R__ Twist						•	•	•		•	•	•	•	•	•			•	•	•	•	•	•	•	•	•	•	•

Price Category 3

3AC__ Ace						21	•			•	•	•	•	•	8			•	•	•	19			•		•	•	
4LN__ Landing [N]																										•		
8M__ Latitude™					23	•	•											•					•	•				

Price Category 4

3DM__ Daydream						21	•	•		•		•	•	•			•	•			•	•	•			•	•	
1DL__ Dialogue																				•								
1A9__ Network																					•							
3SY__ Sync				•		•	•	•		•	•	•	•	•	•			•		•	•	•	•	•	•	•	•	•

continued on next page

Proprietary Textiles Application Chart — Seating continued

• Available

[A] Assigned lead-time textile.

[N] Non-woven textile.

See below for exception notes.

	Aeron® Chairs	Cosm™ Chairs	Mirra® 2 Chairs/Stools	Embody® Chairs	Fuld Nesting Chairs	Sayl® Work Chairs/Stools	Sayl Side Chairs	Setu® Chairs/Stools	Zeph™ Chairs	Verus™ Work Chairs/Stools Back	Verus Work Chairs/Stools Seat	Verus Side Chairs Back	Verus Side Chairs Seat	Verus Plus Chairs	Aside® Chairs	Caper® Chairs/Stools	Lino™ Chairs Back	Lino Chairs Seat	OE1 Storage Trolley Cushion Top	Public Office Landscape® Back	Public Office Landscape Seat	Plex® Lounge Furniture	Swoop™ Lounge Seating - Fully Upholstered	Swoop Lounge Seating - Plywood	Valor™ Seating	Eames® Tandem Sling Seating	Cushion Tops	Workspaces
Price Category 5																												
3CY__Cozy						•	•	•		•	•	•	•	•	•			•				•	•	•	•	•	•	•
14A__Hopsak						•	•	•		•	•	•	•	•	•			•	•		•	•	•	•	•	•	•	•
3SU__Summit [N]						•	•	•		•	•	•	•	•				•			•	•	•	•	•	•	•	•
Price Category 6																												
35__ Balance				•																								
Price Category 7																												
COL Customer's Own Leather [A]	1														8			1									1	
Price Category 8																												
No fabrics available at this time																												
Price Category 9																												
21__ Leather [N]	23														8		•	•						•			•	

Application Note: Herman Miller cannot guarantee material/pattern alignment in adjacent products. For example, a fabric's pattern may not align from one pedestal cushion top to the next, or from one chair to another.

- 1 Refer to price book appendices and Omni for COM/COL information.
- 7 Available on 1" Cushion Tops only.
- 8 Only available on the Aside nonupholstered outer back option (PB).
- 9 Available on Valor upholstered seat only.
- 19 Available on Plex seat only.
- 21 Not available on Sayl upholstered back work chairs.
- 22 Not available on Sayl side chairs with upholstered backs.
- 23 Available in select colors. Refer to "Proprietary Textile Colors-Seating" for color offering.
- 24 Not available on Sayl upholstered High-Back Work Chairs.

Proprietary Textile Colors — Seating

Price Category 1

Customer's Own Material

See Order Information in Appendices.
Assigned lead-time textile. A

8Z Pellicle®

For New Aeron® Chairs
56% elastomeric
44% polyester

23101 Mineral
23102 Carbon
23103 Graphite

AireWeave™ 2

For Mirra® 2 Chairs
67% elastomeric
33% antimony-free polyester

1A701 Alpine
1A702 Slate Grey
1A703 Graphite
1A704 Lime Green
1A705 Cappuccino
1A706 Urban Orange
1A707 Dark Turquoise
1A708 Twilight

Crossing

54" wide
86% antimony-free polyester
14% polyester

8T03 Wicker
8T04 Porcelain
8T05 Warm Grey
8T10 Tomato
8T13 Green Apple
8T16 Periwinkle
8T17 Cerulean
8T18 Indigo
8T19 Shale
8T22 Tin
8T23 Graphite
8T24 Black

Dex

54" wide
100% recycled polyester

3DE01 Frost
3DE02 Silver Pine
3DE03 Stone
3DE04 Shale
3DE05 Charcoal
3DE06 Gossamer
3DE07 Pine

Duo

For Lino™ Chairs
52% polyester
48% elastomeric

4RM01 Mineral
4RM02 Poppy
4RM03 Green Leaf
4RM04 Jade
4RM05 Shadow
4RM06 Graphite

Flexnet™

For Caper® Chairs
69% elastomeric
31% polyester

6V01 Black
6V02 Silver Grey

Gem

54" wide
100% antimony-free polyester

9502 Tangerine
9503 Red
9507 Twilight
9508 Bayou
9510 Berry Blue
9511 Aqua Green
9512 Green Apple
9514 Black
9515 Slate Grey
9516 Fog

Intercept

For Cosm™ Chairs
60% elastomeric
40% polyester

84501 Graphite
84502 Carbon
84503 Mineral
84504 Nightfall
84505 Glacier
84506 Canyon

Interweave 2

For Verus™ Chairs
65% elastomeric
35% polyester

36501 Iceberg
36502 Poppy
36503 Beachglass
36504 Blue Grotto
36505 Slate
36506 Shale

Lyris 2™

For Setu® Chairs
74% elastomeric
26% polyester

4W21 Alpine
4W22 Mango
4W23 Chartreuse
4W25 Berry Blue
4W26 Slate Grey
4W28 Chino
4W29 Rattan
4W30 Java
4W31 Graphite

Monologue

54" wide
56% recycled polyester
44% polyester

1MN01 Linen
1MN02 Alabaster
1MN03 Truffle
1MN04 Folkstone
1MN05 Silver Pine
1MN06 Slate

Monologue *continued*

1MN07 Seed
1MN08 Yellow Oxide
1MN09 Persimmon
1MN10 Tundra
1MN11 Meadow
1MN12 Blue Sky
1MN13 Blue Spruce
1MN14 Deep Sea

Ripple 3D Knit

Available only on Zeph™ Chairs.
knit to size
51% post-consumer recycled polyester
48% polyester
1% lycra

5H201 Black
5H202 Carbon
5H203 Alpine
5H204 Silt
5H205 Tea Rose
5H206 Cocoa
5H207 Persimmon
5H208 Blaze
5H209 Cayenne
5H210 Falcon
5H211 Mustard Seed
5H212 Patina
5H213 Olive
5H214 Moss
5H215 Aloe
5H216 Glacier
5H217 Ultramarine
5H218 Nightfall
5H219 Bluebell
5H220 Boysenberry
5H221 Nightfall/Bluebell
5H222 Patina/Alpine
5H223 Cayenne/Glacier
5H224 Tea Rose/Olive
5H225 Silt/Blaze

Price category 1 continued on next page

Proprietary Textile Colors — Seating

continued

Price Category 1

continued

Appendix: Proprietary Textile Colors — Seating

Scatter	
54" wide	
100% recycled polyester, with 26% ocean bound plastic	
4SC01	Alpine
4SC02	Fog
4SC03	Shale
4SC04	Persimmon
4SC05	Red Violet
4SC06	Lime Zest
4SC07	Olive
4SC08	Glacier
4SC09	Blue Sky
4SC10	Lagoon
4SC11	Slate Grey
4SC12	Blue Black

Scribe	
54" wide	
100% recycled polyester with 53% ocean bound plastic	
3DN01	Spring Wood
3DN02	Poplar
3DN03	Pewter
3DN04	Deep Sea
3DN05	Fir
3DN06	Nutmeg

Splash 3D Knit	
Available only on Zeph™ Chairs. knit to size	
54% post-consumer recycled polyester 44% polyester 2% lycra	
5H101	Black
5H102	Carbon
5H103	Alpine
5H104	Silt
5H105	Tea Rose
5H106	Cocoa
5H107	Persimmon
5H108	Blaze
5H109	Cayenne
5H110	Falcon

Splash 3D Knit continued	
5H111	Mustard Seed
5H112	Patina
5H113	Olive
5H114	Moss
5H115	Aloe
5H116	Glacier
5H117	Ultramarine
5H118	Nightfall
5H119	Bluebell
5H120	Boysenberry

Stretch Knit	
Assigned lead-time textile. A	
Available only on Sayl® Suspension Back Work Chairs 97% polyester, 3% spandex	

3DK01	Fog
3DK02	Slate Grey
3DK03	Java
3DK04	Black
3DK05	Red
3DK06	Green Apple
3DK07	Berry Blue

Tailored	
54" wide	
56% polyester 44% recycled polyester	
23501	Studio White *
23502	Sugar *
23503	Tomato
23504	Orchid
23505	Boysenberry
23506	Chive
23507	Bluegrass
23508	Cobalt
23509	Cadet
23510	Fog
23511	Graphite
23512	Black
23513	Coffee

* Colors not available on
Plex™ Lounge Furniture.

Price Category 2

Aristo	
54" wide	
88% recycled polyester 12% polyester Acrylic backing	
3AR01	Forest Moss
3AR02	Light Brindle
3AR03	Mink
3AR04	Copper
3AR05	Adobe
3AR06	Cherry
3AR07	Lilac
3AR08	Green Apple
3AR09	Surf
3AR10	Waterfall
3AR11	Cadet
3AR12	Tin
3AR13	Pewter
3AR14	Grey Brindle
3AR15	Grey Black

Crepe	
54" wide	
100% recycled polyester, with 43.6% ocean bound plastic	
9201	Licorice
9203	Smoke
9207	Cherry
9223	Cadet
9241	Beachglass
9249	Stone
9251	Fog
9252	Slate Grey
9261	Shale
9262	Graphite
9265	Mineral
9266	Persimmon
9267	Juniper
9268	Glacier
9269	Cascade
9270	Navy

Price category 2 continued on
next page

Proprietary Textile Colors — Seating

continued

Price Category 2

continued

Epic	
54" wide	
56% recycled polyester	
44% polyester	
Acrylic backing	
3EP01	Alabaster
3EP02	Smoke
3EP03	Falcon
3EP04	Citrus Spring
3EP05	Copper
3EP06	Urban Orange
3EP07	Poppy
3EP08	Wild Plum
3EP09	Sugar Plum
3EP10	Clover
3EP11	Loden
3EP12	Everglade
3EP13	Mist
3EP14	Peacock
3EP15	Cadet
3EP16	Indigo
3EP17	Spring Wood
3EP18	Grey Brindle
3EP19	Seed
3EP20	Carbon Dark

Loom	
54" wide	
100% polyester	
1LM01	Linen *
1LM03	Brick and Mortar
1LM04	Salt and Pepper
1LM05	Black
1LM08	Wild Berry
1LM09	Loden
1LM10	Jade
1LM11	Deep Sea

* Color not available on Valor™ Seating

Marvel	
54" wide	
100% pvc-free polyurethane	
1MV01	Summer White
1MV02	Sand Dollar
1MV03	Espresso
1MV04	Folkstone Grey
1MV05	Graphite
1MV06	Onyx
1MV07	Polar Blue
1MV08	Blush Grey
1MV09	Woodrose
1MV10	Citrus
1MV11	Adobe
1MV12	Red
1MV13	Kiwi Green
1MV14	Pine
1MV15	Teal Green
1MV16	Twilight

Medley	
54" wide	
100% polyester	
1HA01	Stone
1HA02	Trail
1HA03	Charcoal
1HA04	Cinder
1HA05	Citrus
1HA06	Papaya
1HA07	Chutney
1HA08	Tundra
1HA09	Feather Grey
1HA10	Chartreuse
1HA11	Loden
1HA12	Peacock
1HA13	Bayou
1HA14	Blue Grotto
1HA15	Blueberry
1HA22	Khaki
1HA23	Pewter
1HA24	Yellow Oxide
1HA25	Vintage Rose
1HA26	Raspberry
1HA27	Acai Berry

Mellow	
54" wide	
100% recycled polyester, with 16% ocean bound plastic	
4ME01	Mineral
4ME02	Pewter
4ME03	Wisteria
4ME04	Olive
4ME05	Glacier
4ME06	Oceanside
4ME07	Charcoal

Rhythm	
54" wide	
100% polyester	
3001	Kiwi Green *
3002	Green Apple *
3003	Peacock *
3004	Bayou *
3005	Berry Blue
3006	Iris *
3007	Twilight
3008	Pumpkin *
3009	Poppy *
3010	Molasses *
3011	Mulberry *
3012	Khaki *
3013	Mink *
3014	Black
3015	Charcoal

* Colors not available on Embody® Chair.

Sequel	
54" wide	
100% vinyl	
100% polyester knit backing	
Resilience® finish	
3SL01	White
3SL02	Pebble
3SL03	Mushroom
3SL04	Stone
3SL05	Chestnut
3SL06	Rattan
3SL07	Black Cherry
3SL08	Tundra
3SL09	Seal
3SL10	Blue Fog
3SL11	Folkstone
3SL12	Shale
3SL13	Slate Grey
3SL14	Charcoal
3SL15	Carbon Dark
3SL28	Navy *

* Color available on Eames® Tandem Sling Seating.

Terra	
54" wide	
100% post-consumer recycled biodegradable polyester *	
4TE01	Spring Wood
4TE02	Zinc
4TE03	Pine Cone
4TE04	Charcoal

* 1% biodegradation in 1,278 days under ASTM D5511 conditions. No evidence of further degradation.

Price category 2 continued on next page

Proprietary Textile Colors — Seating

continued

Appendix: Proprietary Textile Colors — Seating

Price Category 2

continued

Twist	
54" wide	
80% antimony-free polyester	
13% recycled polyester	
7% polyester	
8R05	Wicker
8R10	Poppy
8R14	Tin
8R15	Shale
8R16	Graphite
8R17	Birch
8R18	Sepia
8R22	Blueberry
8R23	Green Apple
8R26	Gunmetal
8R27	Cinder
8R28	Citrus
8R29	Pekoe
8R30	Tangerine
8R31	Red Plum
8R32	Wisteria
8R33	Forest
8R34	Jade Dark
8R35	Waterfall
8R36	Midnight Blue
8R37	Carbon Dark

Price Category 3

Ace	
54" wide	
100% polyurethane	
Polyester knit backing	
Stain resistant finish	
3AC01	Summer White
3AC02	White Ash
3AC03	Rye
3AC04	Metal
3AC05	Clay
3AC06	Chestnut
3AC07	Citrus
3AC08	Camelback
3AC09	Chipotle
3AC10	Claret
3AC11	Slate Purple
3AC12	Artichoke
3AC13	Sepia Dark
3AC14	Aloe
3AC15	Flint
3AC16	Blue Sky
3AC17	Oceanside
3AC18	Midnight
3AC19	Spring Wood
3AC20	Frost
3AC21	Lead
3AC22	Black

Landing	
For Eames® Tandem Sling Seating	
54" wide	
100% TPE	
Polyester knit backing	
4LN01	Black

Latitude™	
61" wide	
100% polyester	
8M01	Graphite
8M02	Shadow
8M10	Alpine
8M17	Black
8M21	Slate Grey
8M22	Lime Green
8M23	French Press
8M24	Urban Orange
8M25	Dark Turquoise
8M26	Twilight

Latitude	
Colors for Mirra 2 Chairs	
100% polyester	
8M10	Alpine
8M17	Black
8M21	Slate Grey
8M22	Lime Green
8M23	French Press
8M24	Urban Orange
8M25	Dark Turquoise
8M26	Twilight

Price Category 4

Daydream	
54" wide	
48% wool	
41% recycled polyester	
9% nylon	
2% polyester	
3DM01	Rye Grass
3DM02	Silver Birch
3DM03	Pewter
3DM04	Graphite
3DM05	Black
3DM06	Lemongrass
3DM07	Permission
3DM08	Juniper
3DM09	Sea Grass
3DM10	Nightfall

Dialogue	
For Public Office Landscape®	
Sectional Back/Social Chair Back	
knit to size	
100% polyester	
1DL01	Light Brindle
1DL02	Dark Brindle

Network	
For Public Office Landscape®	
Sectional Back/Social Chair Back	
knit to size	
100% polyester	
1A901	Warm White
1A902	Fog
1A903	Red
1A904	Wildberry
1A905	Green Apple
1A906	Twilight
1A907	Graphite

Price category 4 continued on next page

Proprietary Textile Colors — Seating

continued

Price Category 4

continued

Sync	
55" wide	
100% polyester	
3SY01	Pine Cone
3SY02	Citron
3SY03	Canyon
3SY04	Truffle
3SY05	Wild Berry
3SY06	Everglade
3SY07	Glacier
3SY08	Nightfall
3SY09	Dark Mineral
3SY10	Slate Grey
3SY11	Dark Carbon
3SY12	Black

Price Category 5

Cozy	
54" wide	
100% wool	
3CY01	Heathered Warm Grey
3CY02	Heathered Rye Grass
3CY03	Heathered Cool Grey
3CY04	Heathered Blue Grey
3CY05	Heathered Black
3CY06	Heathered Persimmon
3CY07	Heathered Loden
3CY08	Heathered Jade
3CY09	Heathered Lagoon
3CY10	Heathered Twilight

Hopsak	
56" wide	
100% recycled polyester	
14A20	Black
14A22	Raw Umber Dark
14A26	Grey Blue Dark
14A30	Sepia Dark
14A38	Emerald Dark
14A39	Yellow Dark
14A40	Orange
14A41	Sienna
14A42	Olive Green Dark
14A43	Crimson
14A44	Crimson Dark Dark
14A45	Violet Dark
14A46	Pink Dark Dark
14A47	Ultramarine Dark
14A48	Cobalt Blue
14A49	Terra Cotta
14A50	Ochre Dark

Summit	
54" wide	
100% silicone	
Polyester knit backing	
3SU01	Bright White
3SU02	Oyster
3SU03	Zinc
3SU04	Sparrow
3SU05	Taupe
3SU06	Java
3SU07	Black
3SU08	Cherry
3SU09	Beachglass
3SU10	Midnight

Price Category 6

Balance	
For Embody® chairs	
100% polyester	
3512	Carbon
3513	Black

Proprietary Textile Colors — Seating

continued

Price Category 7

Customer's Own Leather
See Order Information in Appendices. Assigned lead-time textile. [A](#)

Price Category 8

No fabrics available at this time.

Price Category 9

Leather	
approx. 50 sq. ft. per hide	
100% leather	
2101	Ivory
2109	Black *
2110	Smoke
2111	Graphite
2112	Khaki
2113	Rattan
2114	Truffle
2115	Alpine
2116	Haze
2117	Sable Grey
2118	Dark Mineral **
2119	Dark Carbon ***
2120	Cranberry
2121	Deep Sea

* Armpad color available on Aeron® Chair, Graphite.

** Armpad color available on Aeron Chair, Mineral.

*** Armpad color available on Aeron Chair, Carbon.

For more information about our products and services or to see a list of dealers, please visit us at HermanMiller.com or call (800) 851 1196.

© 2023 Herman Miller, Inc., Zeeland, Michigan

Distribution Rights

Working together since 1956, Herman Miller and Vitra are the authentic sources of designs by Charles and Ray Eames, Alexander Girard, and George Nelson. All the designs shown in this book are protected by law. Herman Miller has obtained all rights to make and sell these designs. Also, Herman Miller holds exclusive worldwide manufacturing and distribution rights for these products with the following exceptions:

Charles and Ray Eames, George Nelson, and Alexander Girard—Worldwide distribution rights for furniture in all areas except Europe and the Middle East. For those areas, please contact Vitra.

Isamu Noguchi—Worldwide distribution rights for the Noguchi Rudder Table. Distribution rights for the Noguchi Table in North America and Central America only. For all other areas, please contact Vitra.

Magis—Exclusive distribution rights in the US and Canada. For all other areas, please contact Magis.

© **HermanMiller**, 3D Intelligent, AO, Action Office, Aeron, ArcSpan, Aside, Avall, Bubble Lamps, Canvas Office Landscape, Caper, Celle, Cosm, Co/Struc, Daisyone, Distil, Eames, Eco-Dematerialized, Embody, Envelop, Ethospace, Exclave, Fine-Tune, FlexFront, Flo, Formcoat, Formwork, Ground Cloth, Kinemat, Layout Studio, Lifework, Lino, Live Unframed, Living Office, Maharam, Meridian, Mirra, Motia, Nelson, Pellicle, Perspectives, Plex, PostureFit, PostureFit SL, Prospects, Public Office Landscape, Rodney, Sayl, Setu, Tu, Ubi, Verus, Wishbone, and Y-Tower are among the registered trademarks of Herman Miller, Inc., and its owned subsidiaries.

™ 8Z Pellicle, About Face, AireWeave, Albert, Ambit, Asari Chair by HermanMiller, Backfit, Bubbletack, Burdick Group, Butterfly Back, Cellular Suspension, Clam, Commend, Compass, Connect, DOT, Duracare, Durawrap, EnhancedAccess, Everywhere, Flex-Edge, Flute, Harmonic, Headway, Herman Miller Select, Hopsak 2, Intent, Iota, Jaw, Keyless Entry, Latitude, Logic Mini, Logic Power Access Solutions, Live Platform, Loop, Lyrus, Lyrus 2, Made-to-Measure Storage, Mora, Multiscrim, Nevi, OE1 Workspace Collection, Overlay, Pari, Pixelated Support, Pronta Stacking Chairs by Herman Miller, Prospect, Renew, Sense, Soft Pad, Stackable, Stackable Storage, Striad, Swoop, Thrive, Tone, TriFlex, Twist, Vista, Wireframe, and Zeph are among the trademarks of Herman Miller, Inc., and its owned subsidiaries.

SM Herman Miller Options is among the service marks of Herman Miller, Inc.

AAP™ is a trademark of Extron Electronics.

Alexander Girard® is a registered trademark of The Alexander Girard Estate.

Chemsurf® is a registered trademark of Wilsonart International.

Corian® is a registered trademark of E. I. du Pont de Nemours and Company Corporation.

Crypton® is a registered trademark of Crypton, Inc.

DACRON® is a registered trademark of INVISTA S.a r.l.

Danzer® is a registered trademark of Danzer Holding AG.

Decora® is a registered trademark of Leviton Manufacturing Co., Inc.

Edelman® Leather is a registered trademark of Edelman Leather, Inc.

Extron® is a registered trademark of RGB Systems, Inc.

FENIX NTM® is a registered trademark of Arpa Industriale S.p.A.

FLEXNET™ is a trademark of Milliken & Company.

Floor Saver Glide® is a registered trademark of Carpin Manufacturing, Inc.

Forest Stewardship Council® is a registered trademark of the Forest Stewardship Council A.C. (FSC). We are FSC® certified (FSC® C102895).

FSC® is a registered trademark of the Forest Stewardship Council A.C. (FSC).

Geiger® is a registered trademark, and Bumper™, Saiba™, and Ward Bennett™ are trademarks, of Geiger International.

Hang-It-All® is a registered trademark of Lucia Eames Demetrios, d.b.a. Eames Office.

Holophane® is a registered trademark of Holophane.

Ingeo™ is a trademark of Cargill Dow LLC.

iPad® and Mac mini® are registered trademarks of Apple Inc.

Leviton® is a registered trademark of Leviton Manufacturing Co., Inc.

LifeSize® is a registered trademark of LifeSize Communications, Inc.

Logitech G® is a registered trademark of Logitech International S.A.

Magis®, Bombo®, and Me Too® are registered trademarks of Magis S.p.A.

MicrobeCare™ is a trademark of Parasol Medical LLC.

Microsoft® and Natural® Keyboard are registered trademarks of Microsoft Corporation.

Noguchi® and the Noguchi table configuration (trade dress) are registered trademarks, and Rudder Table™ is a trademark, of The Isamu Noguchi Foundation and Garden Museum.

Place Textiles® is a registered trademark of Place Textiles.

Sunbrella® is a registered trademark of Glen Raven, Inc.

SuperSeat™ is a trademark of Dahti Seating, a division of ITW.

Valor™ is among the trademarks owned by Nemschoff, Inc.