

# Preliminary Design Review Presentation

Vertical Projectile - AIAA OC Section 2016-2017  
November 28, 2016



# Contents

- Introduction of Team Members
- Mission Statement
- Mentors/Partners in Industry and Education
- Vehicle
  - Design
  - Recovery Subsystem
  - GPS Tracking System
  - Other Subsystems

# Contents cont.

- Engineering Payload
- Risks and Safety
- Educational Outreach
- Budget
- Timeline

# Mission Statement

# Mission Statement

The AIAA OC Section team will construct a rocket that controls its ascent with air brakes to collect data to carbon dioxide levels one mile into the troposphere down to the crust of the lithosphere.

# Mentors/Partners in Industry and Education

# Mentors in Industry and Education

- Robert Koepke
  - Electrical Engineer, Programmer, Level 2 NAR
- Jann Koepke
  - Artist, Mother, Level 1 NAR

# Partners in Industry and Education

- Dr. James Martin
  - Degrees from West Virginia University, Massachusetts Institute of Technology, George Washington University
- Jonathan Mack
  - Electrical Engineer, Programmer
- Guy Heaton
  - Mechanical Engineer
- Mike Stoop
  - Fiberglassing, Programming, Design



# Vehicle

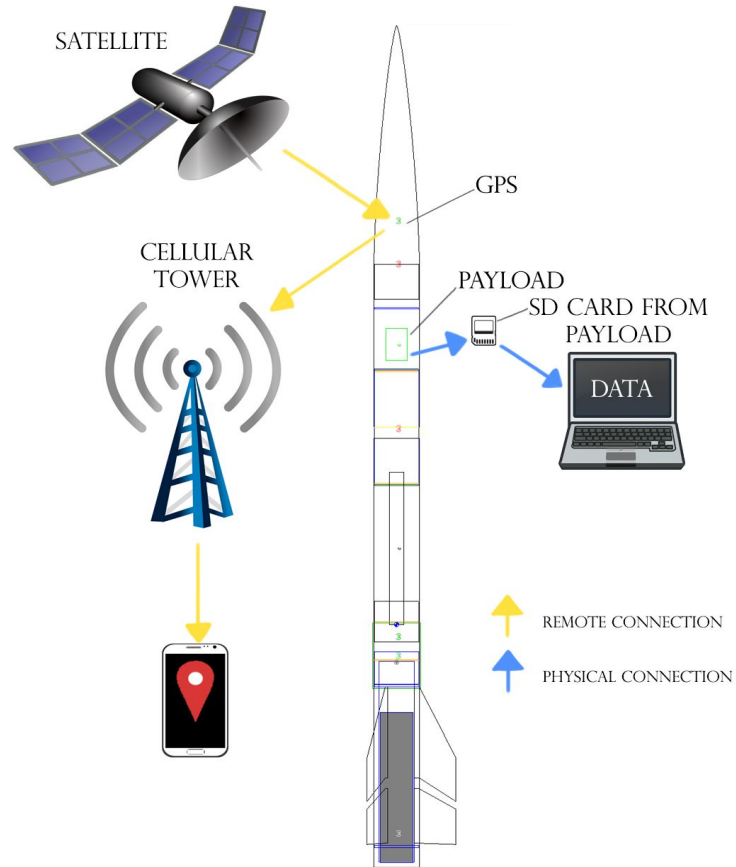

# Vehicle - Design

# Vehicle - Design

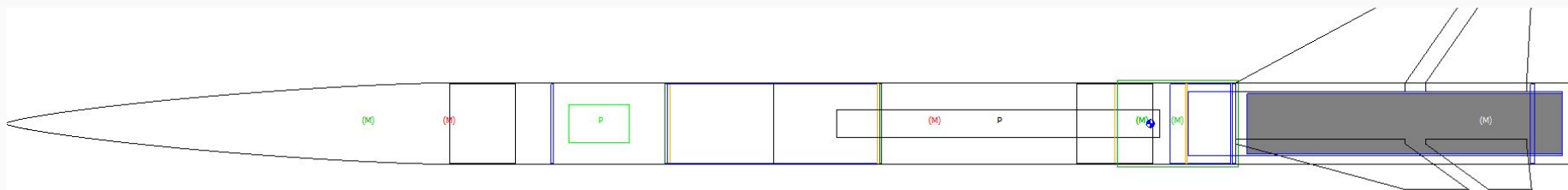

- Length - 77.5 in
- Diameter - 4 in
- Semi Span of Fins - 3.25 in
- Total Mass - 9486.096 g
- Motor Choice - Cesaroni K661
- Recovery Subsystem

# Vehicle - Design

- Stability Margin at rail exit: 2.033 calibers
- Center of Gravity: 55.1429 in
- Center of Pressure: 58.6132 in

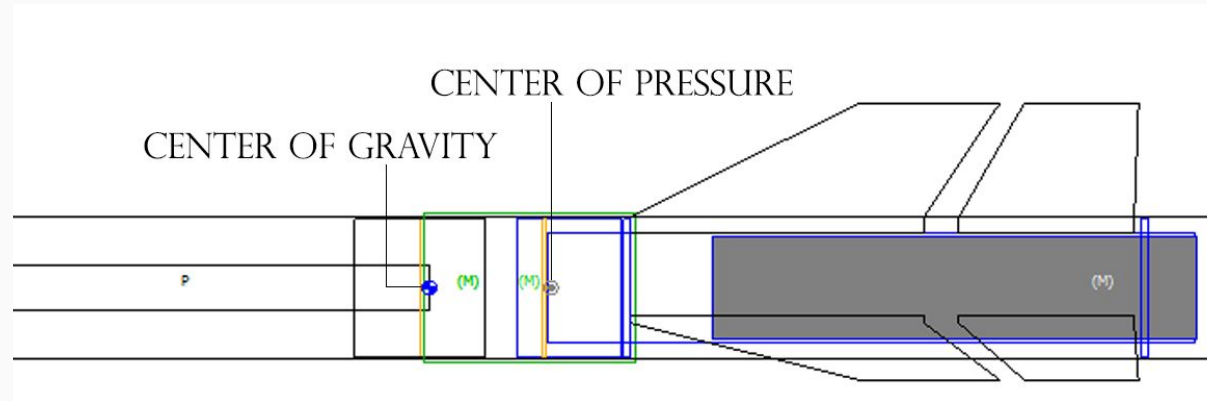

# Vehicle - Design

Smaller Fins: Not Usable

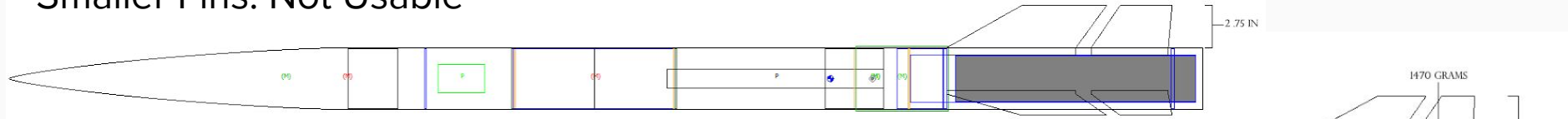

Heavier Bottom: Not Usable

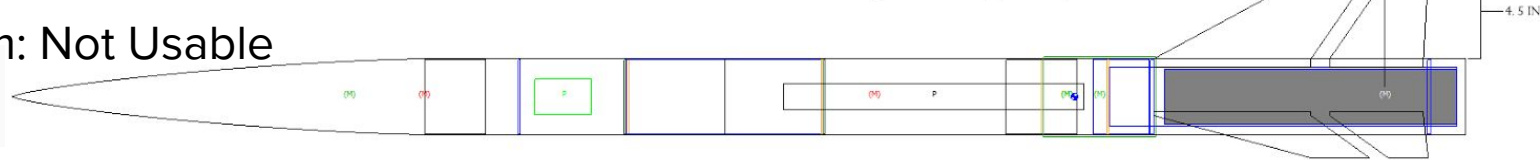

Smaller Fins, Heavier Bottom: Usable

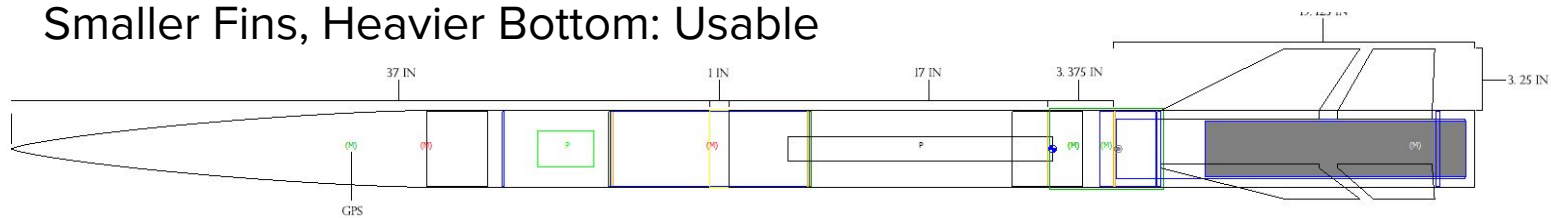

<b>Viable Rocket Designs</b>			
	Smaller Fins	Heavier Bottom	Smaller Fins, Heavier Bottom
Mass (g)	8797.648	10747.203	9486.098
Kinetic energy (lb-ft)*	55.96	84.20	75.788
Parachute Diameter (in)	84	96	84
Total Length (in)	77.5	77.5	77.5
Semi span of fin (in)	2.75	4.5	3.25
Motor	Aerotech K560W	Aerotech K560W	Cesaroni K661
Altitude (ft) with no air brakes in action	6356	5217	5869
Static Stability Margin (calibers)	0.66	1.40	0.86
Stability Margin at Rail Exit (calibers)	1.946	2.105	1.97
Mass Addition in Back (g)	N/A	1470.0	785.0

	Smaller Fins	Heavier Bottom	Smaller Fins, Heavier Bottom
Functionality	-	-	+
Free Space Available for Parachute*	+	-	+
Cost-Effectiveness	0	-	0
Usable	-	-	+



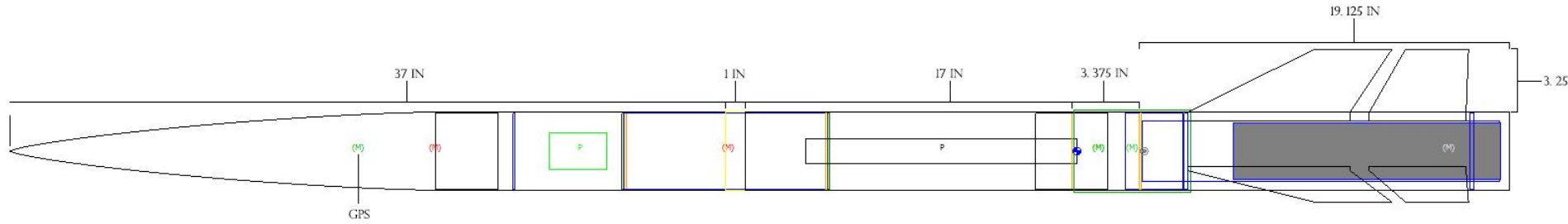
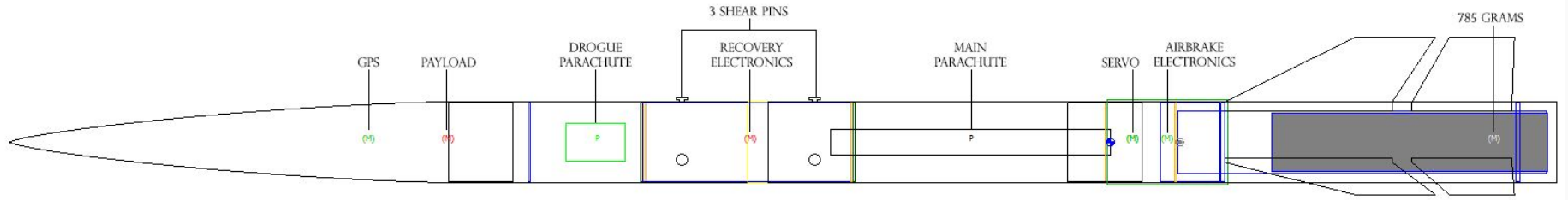

# Motor Selection Comparison

Aerotech Engines	Total Impulse (Ns)	Total Mass (g)	Max Altitude (ft), no air brake function	Max Velocity (ft/s)	Max Accel (ft/s <sup>2</sup> )
<a href="#">K560 (75 mm)</a>	2417.0	2744.0	5889.30	657.09	1864.32
<a href="#">K1050W* (54 mm)</a>	2522.0	2259.0	6354.49	820.41	1863.57
<a href="#">K780R (75 mm)</a>	2,361.1	2934.4	5286.35	674.52	640.38
<a href="#">K1000I (75 mm)</a>	2496.6	2575.0	6072.80	772.36	1864.45
Cesaroni Engines	Total Impulse (Ns)	Total Mass (g)	Max Altitude (ft), no air brake function	Max Velocity (ft/s)	Max Accel (ft/s <sup>2</sup> )
<a href="#">K570 (75 mm)</a>	2070.3	1685.0	5213.09	639.91	1863.41
<a href="#">K590 (75 mm)</a>	2415.3	1994.0	6240.62	693.69	1844.53
<a href="#">K661 (75 mm)</a>	2436.5	2527.8	5869.09	707.01	1864.27

\*The average thrust on this RockSim engine file differed from the data given by [thrustcurve.org](http://thrustcurve.org). The average thrust that thrustcurve.org gave was 1062.3 N. The average thrust given by the RockSim engine file is 1025.218 N. The burn time also differed: 2.46 sec on the file, 2.4 sec on thrustcurve.org

# Vehicle - Subsystems

# Vehicle - Recovery Subsystem

## Dual Deployment Configuration

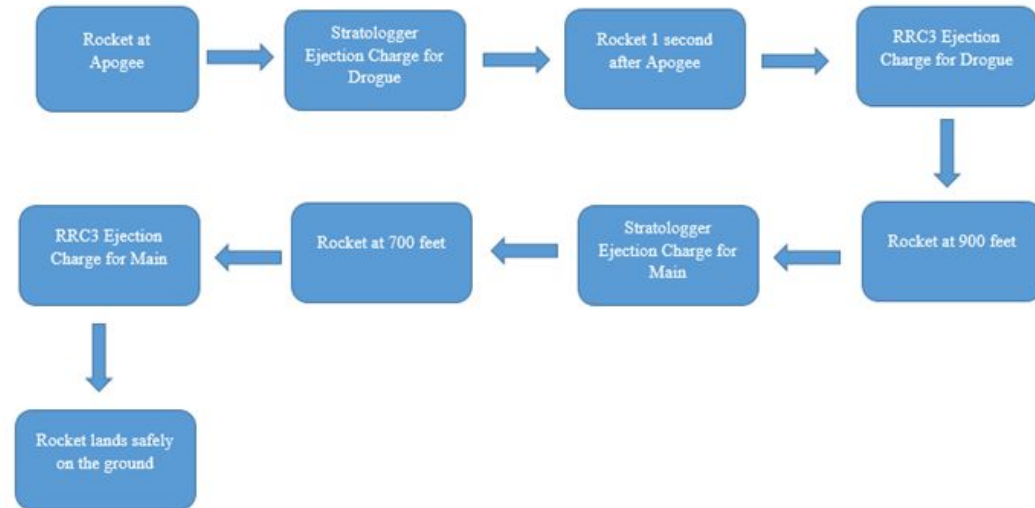
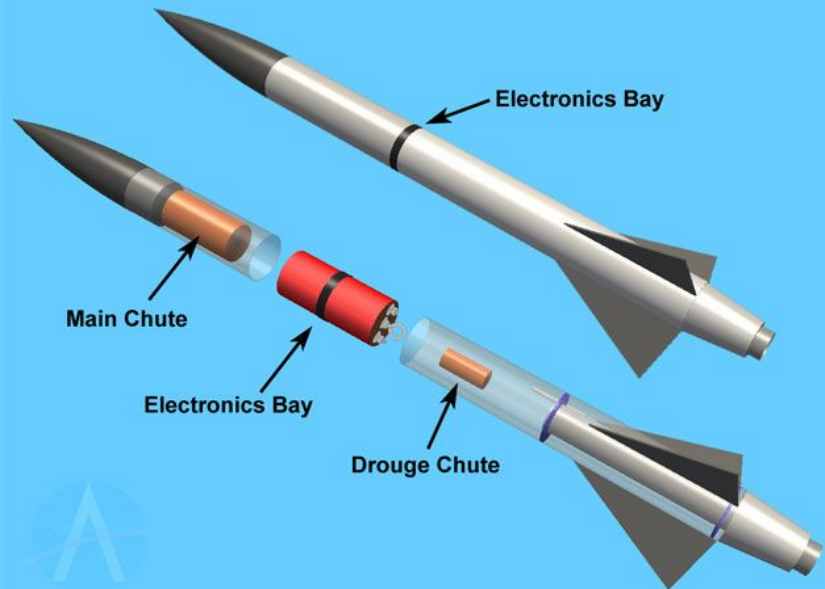

# Vehicle - Recovery Subsystem

- Primary set of recovery electronics - Stratologger CF Flight Computer
- Backup set - RRC3 Flight Computer

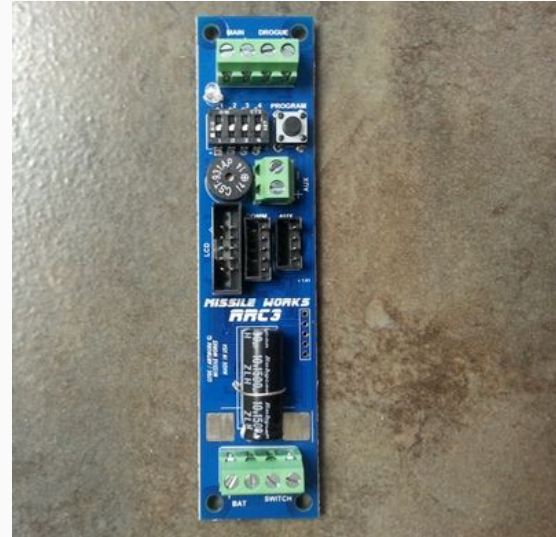
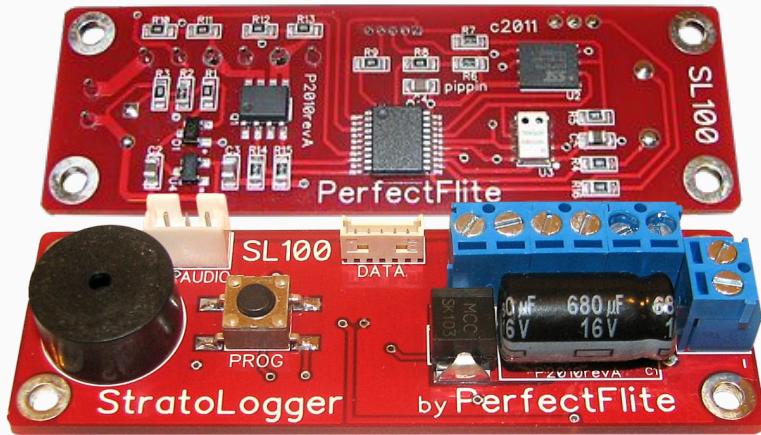

Flight Computer	Pros	Cons
G-Wiz HCX	Easily programmable, dual deployment can be set in 100 foot increments. Comes with an SD card to record flights. Can also be used with 2 batteries to optimize safety.	Not available for sale anymore.
<a href="#">Stratologger CF</a>	Easy to program, reliable manufacturer (PerfectFlite). It can record altitudes up to 100,000 feet, and stores 20 flights a second. Main deployment can be set in 1 foot increments for more precision.	Can only launch drogue at certain altitudes. Doesn't allow two batteries for increased safety.
<a href="#">RRC3 Sport</a>	Easy to program and is pre set up at drogue deployment at apogee and main deployment at 500 feet. Reliable manufacturer (Mad Cow Rocketry) which we used in TARC. Allows two batteries.	Bigger than the stratologger and heavier (17g).

<a href="#">TeleMega Altimeter</a>	Has an on board integrated GPS receiver (eliminating need for dog collar). Has accelerometer. Pyro events like dual deploy can be configured to specific heights and times to increase accuracy.	Really expensive (costs \$500). Relatively heavy (25g).
<a href="#">Raven Flight Computer</a>	Really small (saves space). High quality data (accelerometer, barometric pressure, etc). Main deployment at 700 feet (fits with our deployment plan).	Hard to program. No flexibility with main deployment (can't change the altitude). Really expensive (\$155).

# Vehicle - Recovery Subsystem

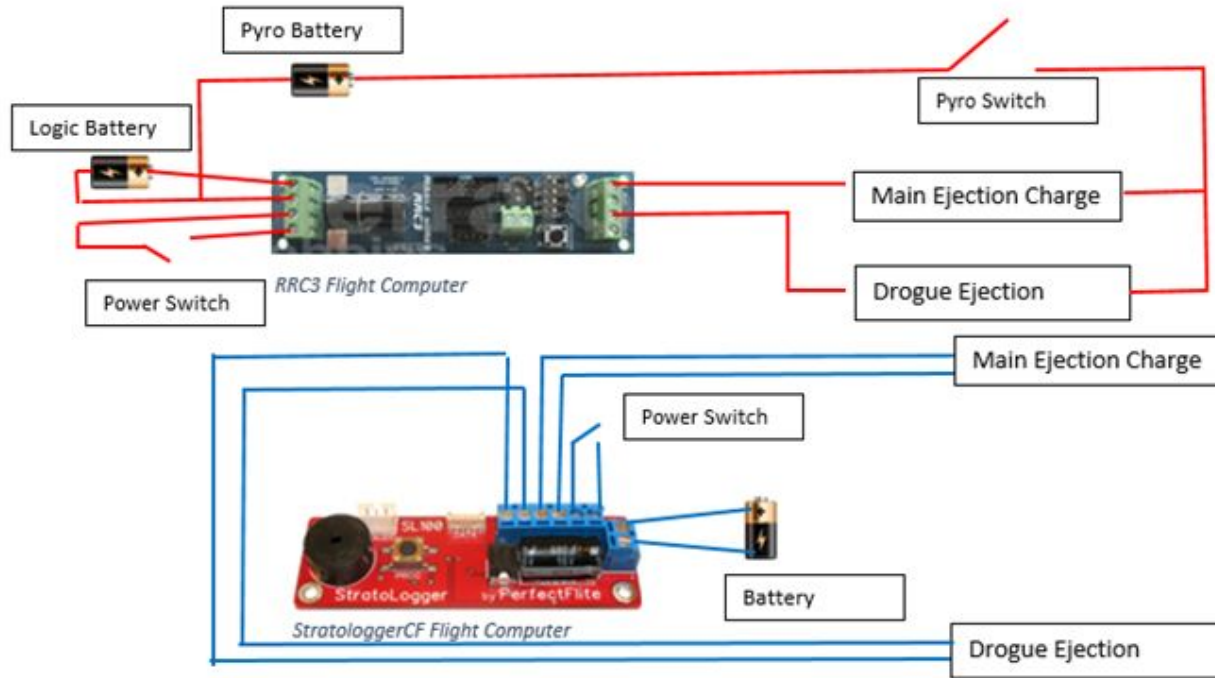

# Vehicle - GPS Tracking Subsystem

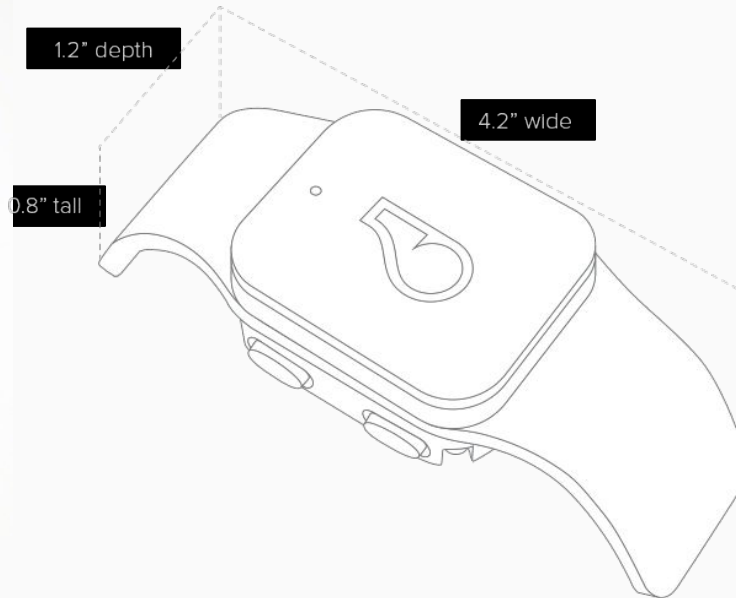



GPS system	Pros	Cons
Whistle GPS dog tracker	Easy to use because it requires knowledge of using a smartphone app. It can be recharged easily using the base station and is not dependent on any other external electronics. No additional telemetry required.	Only works where there is cellular coverage. Bigger than the other GPS options. More expensive because of money needed for cellular service.
EM-506 GPS Receiver	Really small, really accurate in rough geographical conditions like canyons, relatively cheap.	Relatively difficult to use compared to dog tracker. Also not as durable. Additional telemetry may be required.
Arduino GPS tracker	Small and easy to set up. It will be easy for us to use because of our experience with Arduino in TARC.	Additional space required for battery, really expensive, will require use to use a new and unfamiliar version of Arduino. Additional telemetry may be required, making it relatively harder to use.

# Vehicle - Airbrake Subsystem

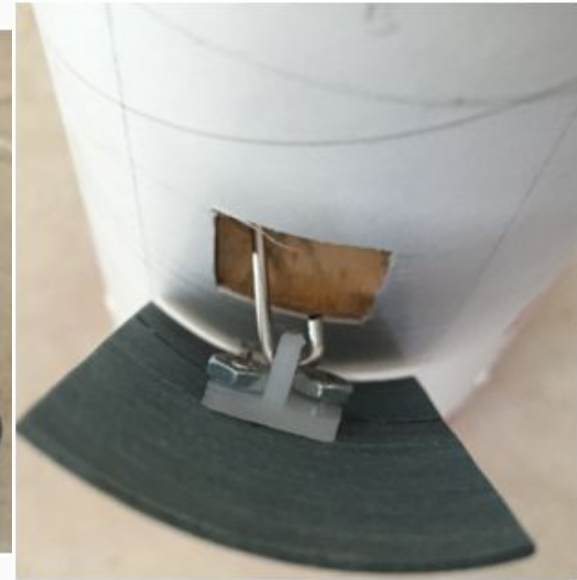
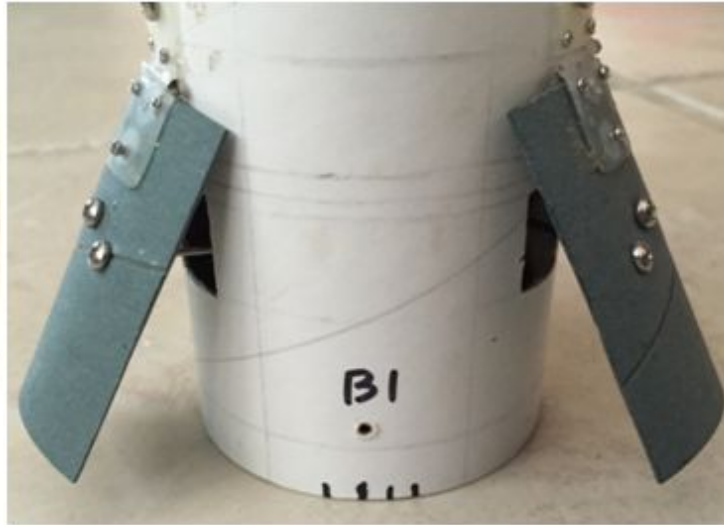
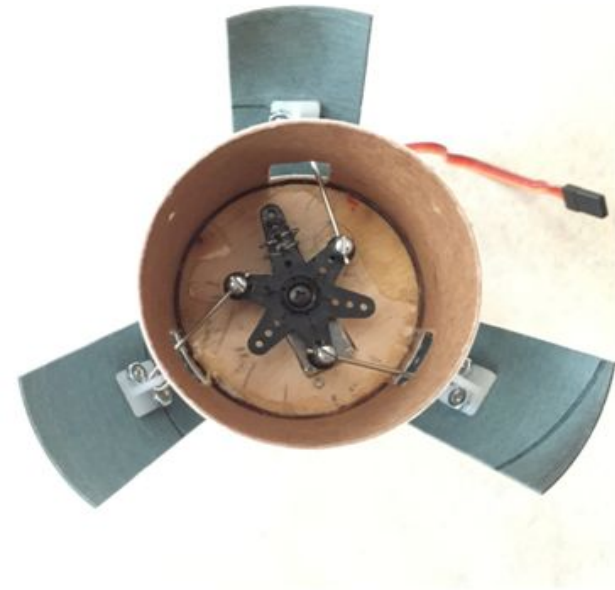

# Vehicle - Airbrake Subsystem

## Teensy 2.0

- 1.2" x 0.7" x 0.125"
- Arduino compatible
- Will independently control air brakes

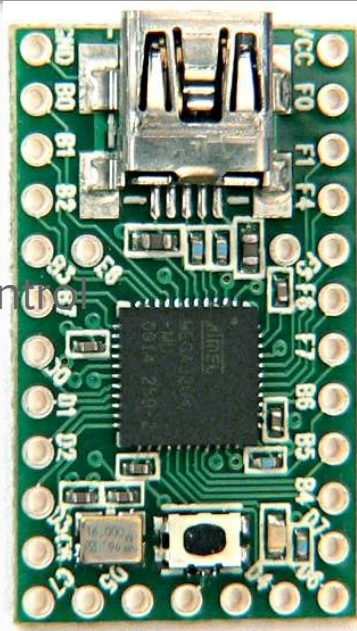

Teensy 2.0, by Itself

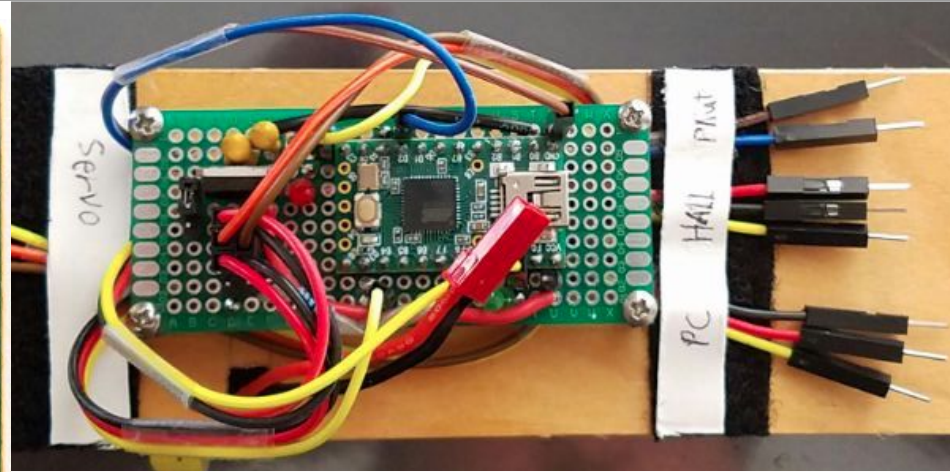

Teensy 2.0, with Arduino-compatible wires

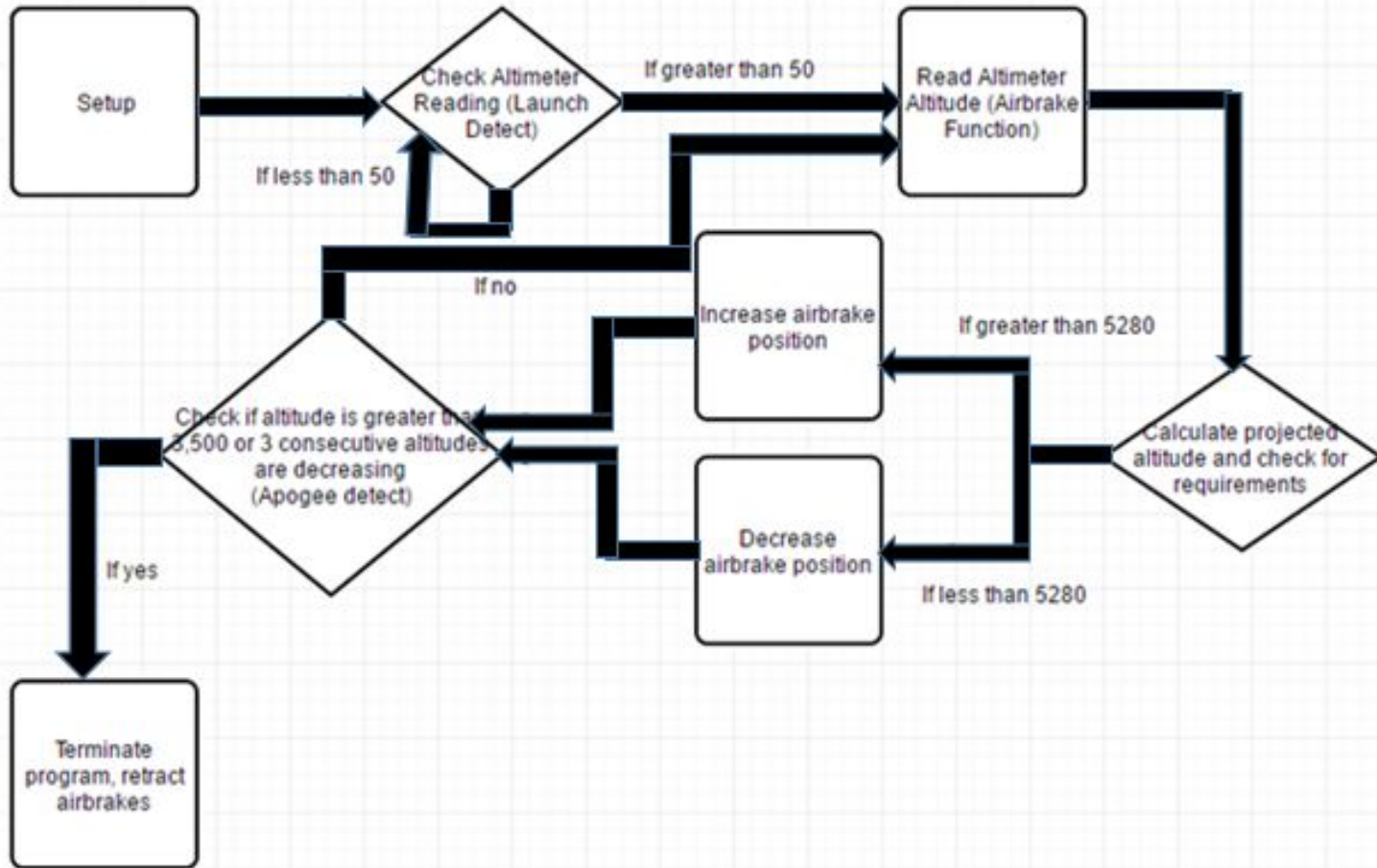

# Vehicle - Airbrake Subsystem

Dimensions	1.72" x 0.88" x 1.57" (43.8 x 22.4 x 40 mm)
Product Weight	2.76 oz (78.2g)
No-Load Speed (6.0V)	0.21 sec/60°
No-Load Speed (7.4 V)	0.17 sec/60°
Stall Torque (6.0V)	500oz/in (26 kg.cm)
Stall Torque (7.4V)	<u>611oz/in</u> ( <u>44kg.cm</u> )
Travel per $\mu$ s (out of box)	.080°/ $\mu$ sec
Travel per $\mu$ s (reprogrammed high res)	.132°/ $\mu$ sec

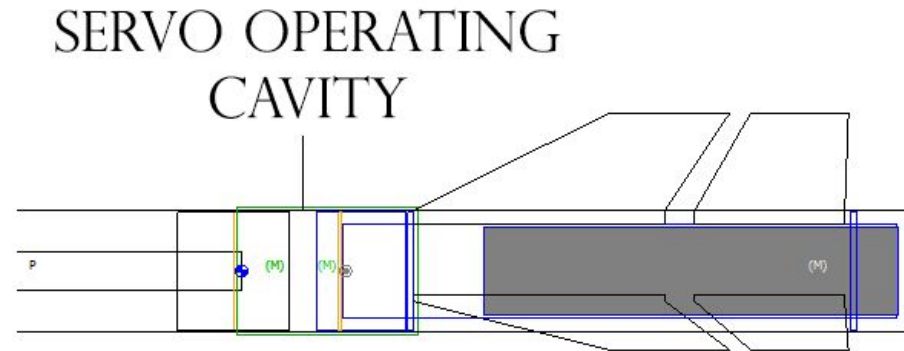

# Scientific Payload

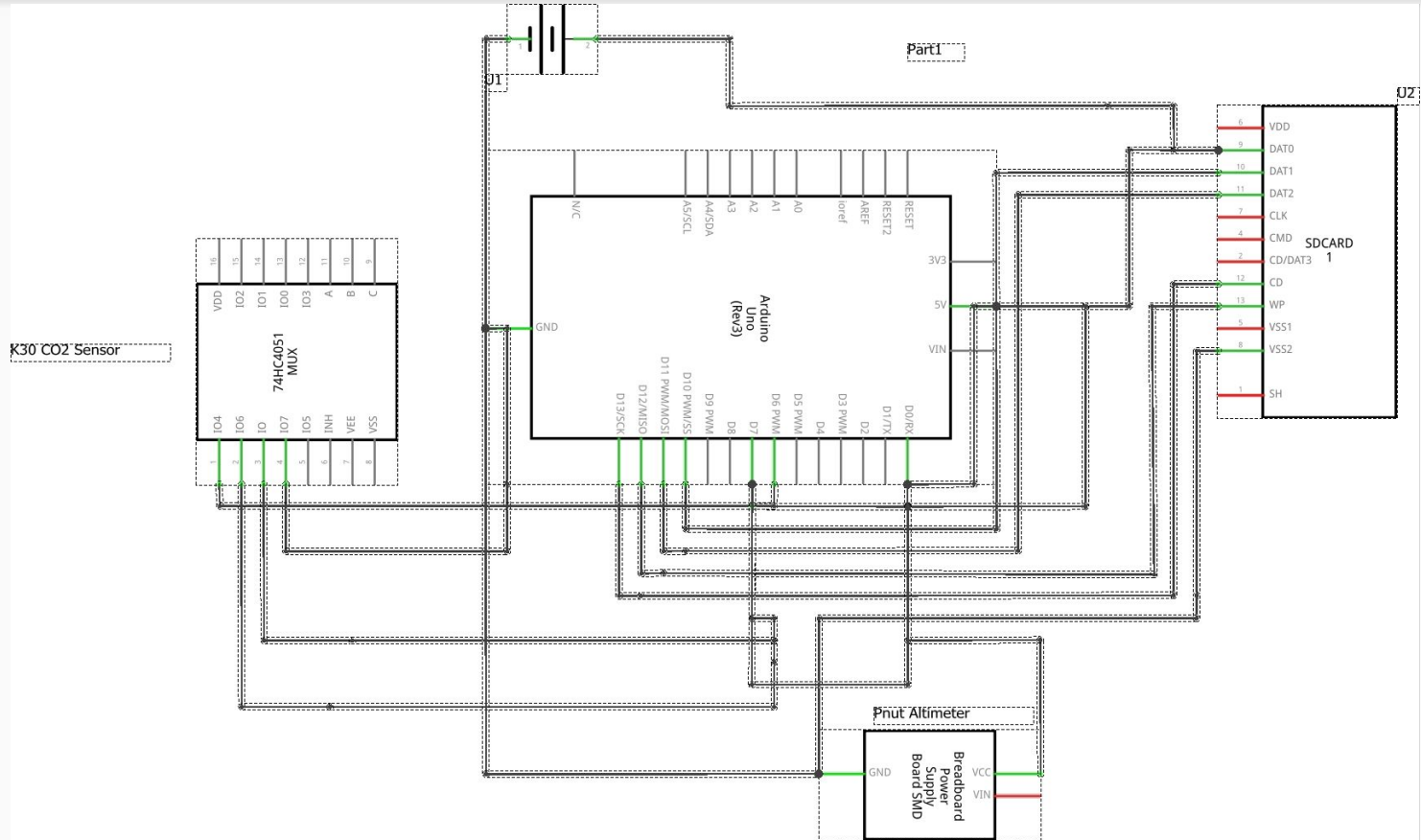

# Scientific Payload

K30 CO<sub>2</sub> sensor

-2.25" X 2"

-17 grams

Top View



Bottom View

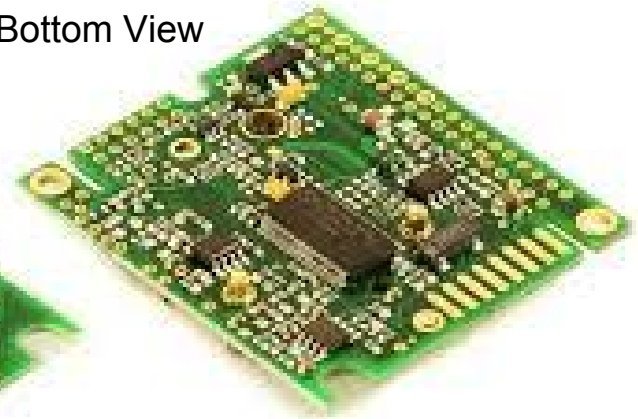



Alternative	Pros	Cons		electric control board.	
Arduino Uno	Easily programmable and comes with wires, breadboard, resistors, and other accessories.	Slow software processing speed.	Breakout Board for MicroSD RB-Spa-197	Simple to control and very small too.	More costly.
Raspberry Pi	Easily programmable and has a software processing speed about 60 times faster than that of Arduino.	Slow hardware response time.	Pnut Altimeter	Very precise: yields a 0.1% accuracy. Reports battery voltage and immune to false triggering.	More expensive.
K30 CO2 Sensor SE-0018	High measurement range: 0-10,000 ppm. Very accurate and simple to program.	Requires holes in the rocket around the sensor to ensure air flow. More expensive too	Firefly Altimeter	Cheap and has a large battery life	Too simple. Not as many features as Pnut.
TMP36 Temperature Sensor	Very small and light. Easily assembled and simple to program.	Outputs voltage proportional to the temperature so doesn't give exact temperature.	9v Battery	Easily used through the Arduino's built in regulator when the battery is placed in its battery casing that attaches to the Arduino.	Not rechargeable
Micro SD Storage Board	Easy to program and very cheap. Perfect small size for the	Has a 2-200mA current range which is high.	Two cell Lipo Battery	500mAH and rechargeable.	Requires regulator to make energy usable for the Arduino.

# Scientific Payload

1. Micro SD Storage Board
2. PerfectFlite Pnut Altimeter
3. 9V Battery

2.



1.



3.



# Safety

# Safety

<b>Risk</b>	<b>Mitigation</b>
Impact to the body	Gloves, apron, goggles
Cut or puncture	Gloves and Apron
Chemicals – fumes and/or direct contact	Gloves, respirator, goggles
Heat/cold	Gloves
Harmful Dust and small particles	Mask and Goggles
Loud noises	Earplugs

- The following items will be present and available for team member use whenever they are working, constructing the vehicle or payload, or launching.
  - Safety goggles
  - Rubber gloves
  - Protective aprons
  - Ear Plugs
  - Leather gloves
  - Respirators / Dust Masks

# Safety

Eye protection must be worn whenever there is a danger of:

- Dust, dirt, metal, or wood chips entering the eye. This can happen when sawing, grinding, hammering, or using power tools.
- Strong winds during a launch (common at Lucerne Dry Lake)
- Chemical splashes when using paints, solvents, or adhesives
- Objects thrown (intentionally or inadvertently) or swinging into a team member

These types of gloves must be worn to protect the team member's hands whenever there is danger of contact with a hazardous material:

- Latex or rubber gloves for possible contact with hazardous chemicals such as adhesive, paint, or thinners, or dangerous solid materials.
- Leather gloves to protect against impact, cuts, or abrasions (e.g. in the use of some power tools such as grinders)

# Safety

Team members will always work in a clean, well-ventilated area. Protection for a team member's lungs (dust mask or respirator) must be used when:

- Working with chemicals emitting fumes (e.g. paints and solvents). In this case, the team member must wear a respirator.
- Working in an environment where there is dust (e.g. sanding and working with power tools). The team member must wear a dust mask.

Body protection, such as an apron must be worn whenever there is danger of:

- Splashes or spills from chemicals
- Possible impact from tools

Ear protection (plugs or ear muffs) must be worn whenever there are loud noises present, which include:

- Using loud power tools or hammers
- Launching larger rocket motors at launches

<p>1. Risk - The engine does not ignite while conducting the launch of the rocket.</p> <p>Mitigation - Prior to launch, multiple team members will check to make sure the igniter is properly inserted in the engine to its full length, ensuring ignition of the motor.</p>	<p>4. Risk - The rocket body caves in, or collapses on itself.</p> <p>Mitigation - The team will use fiberglass for the body tube, a material capable of withstanding outside forces. Inside, flight boards, bulkheads, and centering rings will help to maintain the circular frame of the body tube.</p>	<p>7. Risk - The electronic matches fall out of their designated place.</p> <p>Mitigation - Before placing the shear pins, the matches will be checked to ensure that they have been tightened down to remain in place. This task will be placed on a checklist that members will go through while preparing the rocket for launch.</p>
<p>2. Risk - The engine does not fit (too loose or tight) in the motor casing.</p> <p>Mitigation - The team will make sure the engine is inserted in the proper motor casing, and cannot be shaken or pulled out with ease. The team will also check when the motor casing is inserted into the motor mount.</p>	<p>5. Risk - The quick links are not attached properly.</p> <p>Mitigation - The team will double check all connections to ensure that the rocket is assembled completely before preparing the rocket for launch. These tasks will be written on a checklist, which members who checked the task will sign off to take responsibility.</p>	<p>8. Risk: Motor explodes</p> <p>Mitigation: Detailed instructions will be followed step by step when building the motor. Team members will be required to maintain focus and detail while putting together the motor</p>
<p>3. Risk: Airbrakes do not function while in flight.</p> <p>Mitigation: When electronics are activated at ground level, a test for airbrake function will be performed. The airbrake motors will be checked prior to assembling the whole rocket.</p>	<p>6. Risk - The shear pins do not shear due the ejection charge.</p> <p>Mitigation - When purchasing the pins, the team will note the force required to shear them. The team will perform black powder ground tests to make sure the ejection charges exert more force than the pins can withstand. To ensure shearing, the backup charge will have a greater amount of black powder.</p>	<p>9. Parachute was not packed correctly and does not deploy</p> <p>Mitigation: The team will check to make sure the parachute is fitted correctly into the body of the rocket prior to launch. However if the primary ejection charge does not separate the rocket, backup ejection charges with greater amounts of black powder will allow the parachute to deploy.</p>

<p>1. Risk: SD card is defective</p> <p>Mitigation: Test run before the actual flight.</p>	<p>4. Risk: SD card is not plugged in</p> <p>Mitigation: Double check that the SD card is properly placed in its socket.</p>	<p>7. Risk: Arduino fails to start.</p> <p>Mitigation: Program an LED light to blink when the Arduino is connected to the power supply.</p>
<p>2. Risk: Batteries are not fully charged</p> <p>Mitigation: Charge the batteries to max before the flight.</p>	<p>5. Risk: Wires detach from the Teensy</p> <p>Mitigation: Securely strap the wires to the circuit board using Velcro or other adhesives.</p>	<p>8. Risk: Defective CO2 Sensor</p> <p>Mitigation: Test run before the actual flight.</p>
<p>3. Risk: The VCC is not connected to the sensor, so the sensor does not work</p> <p>Mitigation: Check if the supply wire is securely attached from the 5 volt pin of the teensy to the Sensor.</p>	<p>6. Risk: Batteries fail</p> <p>Mitigation: Use Voltmeter to check if the battery is fully charged before the flight.</p>	<p>9. Risk: The supply and ground wires are switched.</p> <p>Mitigation: Have two other people keep an eye on the wire connections.</p>

<p>1. Risk: Backup ejection charges do not ignite.</p> <p>Mitigation: Check to make sure the RRC3 is beeping in the specific sequence as denoted in the manual.</p>	<p>4. Risk: Drogue chute flies at wrong altitude</p> <p>Mitigation: Double check that the Stratologger and RRC3 both are beeping in their specific sequences.</p>	<p>7. Risk: Main chute doesn't deploy</p> <p>Mitigation: Backup Flight Computer and ejection charges should take care of this.</p>
<p>2. Risk: The Batteries of Backup Electronics Fall out</p> <p>Mitigation: Use battery holders and zip ties to ensure that the batteries do not fall out, and double check the sturdiness of these before every launch.</p>	<p>5. Risk: Airbrakes fail to close, interfering with recovery</p> <p>Mitigation: Double check that the LED light is blinking on the Arduino. Also, make sure the most recent code is uploaded in the Arduino.</p>	<p>8. Risk: Stratologger CF Flight Computer is not turned on</p> <p>Mitigation: The team will have three members check the Stratologger to see if it is beeping in its specific sequence, and they will affirm its status by signing their name in the checklist.</p>
<p>3. Risk: The Backup RRC3 Flight Computer is not turned on</p> <p>Mitigation: The team will have three members check the Flight Computer to see if it's beeping and affirm its status by signing their name in the checklist.</p>	<p>6. Risk: Drogue doesn't deploy</p> <p>Mitigation: Double check that the electronics are turned on and beeping, and have three people sign the checklist to affirm. Also, back up ejection charges will take care of this.</p>	<p>9. Risk: Main batteries fail</p> <p>Mitigation: Use fresh batteries and make sure the electronics will power up first in a test second before flight.</p>



Potential Issues/ Failure Mode	Potential Failure Effects	Severity (1-10)	Potential Causes	Occurrence (1-10)	Mitigation
Battery for the CO2 Sensor (payload) explodes or fail.	The rocket can be damaged, forcing a complete redesign and new construction process.	9	Incorrect wiring or the battery cannot withstand certain malfunctions in the coding.	1	The team decided to switch to a 9 volt battery to better suit the payload. A checklist will be followed when constructing the rocket so no incorrect actions will occur.
The CO2 Sensor fails to work during the launch.	Experiment cannot be conducted. Sparking could occur within the rocket.	5	Wiring is incorrect. Battery was not activated, or no connection in the circuit.	1	A checklist will be followed during construction and when preparing the rocket to launch.
The rocket does not fly in a stable manner.	Altitude might not be met. Damage to the rocket can occur. The rocket will fly uncontrollably, possible hurting someone.	6	While constructing the rocket, mass change might have occurred. During the design process, stability margin might not have been considered. Weather conditions also influence instability.	3	Stability margin is always looked at when designing the rocket and when making any changes to that design. Weather conditions will be monitored, and the rocket will not be launched in unsafe conditions.

Potential Issues/ Failure Mode	Potential Failure Effects	Severity (1-10)	Potential Causes	Occurrence (1-10)	Mitigation
Wind speeds are unsuitable for launching the rocket.	If rocket is launched, rocket will fly in an unstable manner, making it difficult for performing proper tasks.	6	Environmental conditions are not suitable and worsen as the day proceeds at Lucerne Dry Lake.	6	Launch rail can be tilted at an angle that is with the wind in correlation with the speed of the wind. If wind speeds are too strong, the team will wait for conditions to improve.
Rain falls when the rocket is on the launch pad or in preparation.	Drag increases, resulting a possible lower altitude for the rocket. Stability also decreases.	5	Weather conditions are not suitable.	4	Rocket will be launched if rain is light; if rain is too strong, the team will wait for conditions to improve.
A fire can spread to the surrounding environment.	The launch site can catch on fire, resulting in damage to the nature.	9	Rocket can malfunction and once it lands, a fire can begin. Malfunction of the motor, sparks or ignition can set the rocket on fire.	0	If the rocket does catch on fire in any way, no parts of the environment will catch on fire. There is only dirt at Lucerne Dry Lake for miles. No grass is near the launch site.
The rocket will affect trees, power lines, buildings, or people not involved in the launch.	The rocket could hurt people near the launch site who are not aware. It may cause additional damage to the surrounding environment.	9	If the rocket is not stable, it may go off in the wrong path. Instability can be caused by the weather or rocket design.	1	There are no power lines, trees, or buildings within miles of the launch site. People nearby will be warned prior to the launching of the rocket. Stability margin of rocket will be made sure to be within safe limits during the design process.

Risk	Likelihood	Impact	Mitigation Technique
Time	M	H	<p>If we do not have enough time, then there is nothing to do other than to work harder and reduce quality. To prevent this, we will create a coherent work schedule, divide the work evenly, and clearly delineate the formatting of the deliverables for uniformity in advance.</p> <p>Failing to meet deadlines in time may result in the termination of the SL team's participation.</p>
Budget	M	M	<p>If we run out of funds, we can either fundraise or gather money from within the team. The first method would guarantee a minimum \$100 profit. The second would guarantee a minimum \$700.</p>
Functionality	L	H	<p>If functionality within the project decreases, then we can mitigate this risk by providing clear work schedules and creating team activities to relax.</p>
Resources	L	M	<p>If we run out of resources, we can buy more and use our funds.</p>

Key	
L	Low
M	Medium
H	High

# Educational Outreach



# Educational Outreach

## IvyMax Presentation - Date TBD

- Our SL Team will present our team's progress and mission to the IvyMax students and families.
- We will hand out fliers so they will have a better understanding of what we want to do.
- Fliers will also be posted around the office, allowing people to spread them and raise awareness about our project.

# Educational Outreach

## Girl Scouts - Nov. 5, 2016

- Our team has presented to the Girl Scouts of Orange County and introduce them to the basics of rocketry
- Helped them build small model rockets, teaching them about rockets and the necessary components.
- They in turn, can tell their friends about our team and raise support in our community.





# Educational Outreach

## Orange County Model Engineers Presentation - Jan. 7, 2016

- We will talk about our SL team and rocketry to the people attending the presentation.
- Fliers will also be spread out to the group.
- This non-profit organization is located in Costa Mesa



# Budget

Description	Unit Cost	Quantity	Subtotal
<b>Scale Vehicles and Engines</b>			
3" Fiberglass Frenzy XL	\$200.00	1	\$200.00
3" G12 Thin-Wall Airframe (12" length)	\$20.00	1	\$20.00
3" G12 Coupler (6" length)	\$14.00	2	\$28.00
3" G12 Coupler (9" length)	\$21.00	1	\$21.00
HS-7980TH	\$190.00	1	\$190.00
2-56 wire	\$10.00	1	\$10.00
1/4" Machine Closed Eye Bolt	\$18.00	4	\$72.00
Heavy unit easy connector	\$5.00	1	\$5.00
Iris Ultra 72" Compact parachute	\$265.00	1	\$265.00
12" Elliptical Parachute	\$47.00	1	\$47.00
Cesaroni J240RL	\$85.00	1	\$85.00

**Total Scale Vehicle Cost****\$943.00**



# Budget - Vehicle Cost

49

4" G12 Coupler (12" length)	\$31.00	3	\$93.00
4" G12 Coupler (8" length)	\$21.00	2	\$42.00
4" Fiberglass Frenzy XL	\$300.00	1	\$300.00
4" G12 Airframe (12" length)	\$23.00	1	\$23.00
75mm Aerotech K560	\$70.00	3	\$210.00
HS-7980TH	\$190.00	1	\$190.00
2-56 wire	\$10.00	1	\$10.00
Aero Pack 75mm Retainer (Fiberglass Motor Tubes)	\$44.00	1	\$44.00
Shock Cord Protector Sleeves of Kevlar	\$10.00	3	\$30.00
1 Inch Black Climbing Spec Tubular Nylon Webbing	\$12.00	2	\$24.00
3/8" Machine Closed Eye Bolt	\$30.00	4	\$120.00
4" G10 Airframe Plate	\$6.00	8	\$48.00
3" G10 Airframe Bulkplate	\$5.00	8	\$40.00
3" Aluminum Bulkplate	\$15.00	4	\$60.00
4" Aluminum Bulkplate	\$20.00	4	\$80.00
4" Coupler Bulkplate	\$4.00	4	\$16.00
3" Coupler Bulkplate	\$3.50	4	\$16.00
Electric Matches	\$1.50	60	\$90.00
Aero Pack 54mm Retainer (Fiberglass Motor Tubes)	\$29.00	1	\$29.00
Cesaroni K661	\$150.00	5	\$150.00

**Total Vehicle Cost**

**\$1,620.00**

**Recovery**

Iris Ultra 120" Compact Parachute	\$504.00	1	\$504.00
24" Elliptical Parachute	\$60.00	1	\$60.00
4F Black Powder	Kept by mentor		
Batteries (9v, 2 pack)	\$7.00	3	\$21.00
Battery Holder	\$1.00	5	\$5.00
Stratologger CF Flight Computer	\$55.00	1	\$55.00
RRC3 Flight Computer	\$70.00	1	\$70.00
PerfectFlite Pnut (2 units)	\$55.00	2	\$110.00

**Total Recovery Cost****\$825.00**

**Payload**

K30 CO2 Sensor	\$85.00	1	\$85.00
Arduino Uno kit (includes LED, resistors, regulators, etc)	\$35.00	1	\$35.00
SD card + Adapter	\$10.00	1	\$10.00
PerfectFlite Pnut Altimeter	\$50.00	2	\$100.00
Lithium Ion Batter (rechargeable)	\$100.00	1	\$100.00

**Total Payload Cost****\$330.00**

## GPS System

Whistle GPS Dog Tracker Kit	\$75.00	1	\$75.00
Cellular Service Fee (3 months free, 5 months to pay)	\$40.00	1	\$40.00

**Total GPS Cost**

**\$115**

## Educational Outreach

Color fliers (250 copies)	\$170.00
---------------------------	----------

**Total Educational Outreach Cost**

**\$170**

**Travel (7 Members)**

Trips to Lucerne (\$2.80/gal, 112mi; \$21.00 per trip per car)

Huntsville, Alabama (roundtrip plane ticket)	\$332.00	7	\$2,324.00
--	----------	---	------------

Hotel (4 rooms, 6 days)	\$130.00	24	\$3,120.00
-------------------------	----------	----	------------

Hotel (2 people per room, 6 days)	\$25.00	6	\$1,050.00
-----------------------------------	---------	---	------------

**Total Travel Cost (Estimated)****\$6,494.00****Total Estimated Project Expenses****\$10,497**

# Budget - Funding Plan

- Sponsors
  - Apex Desks
  - Pegasus Management
  - Yogurtland
  - IvyMax
  - Velur Enterprises, Inc.
- Additional Funding plan
  - See's Candies
  - Mary Kay cosmetics
  - Garage sale
  - Donations
  - Businesses and Aerospace Companies

# Timeline

The timeline is available [here](#).

# Scale Model

