



AMERICAN ELECTRIC EQUIPMENT, INC.

P.O. BOX 710 BECKLEY, WV 25801

PHONE: 304-255-7438

FAX: 304-255-7448

PL12039-702

Document A-13623

July 30, 2013

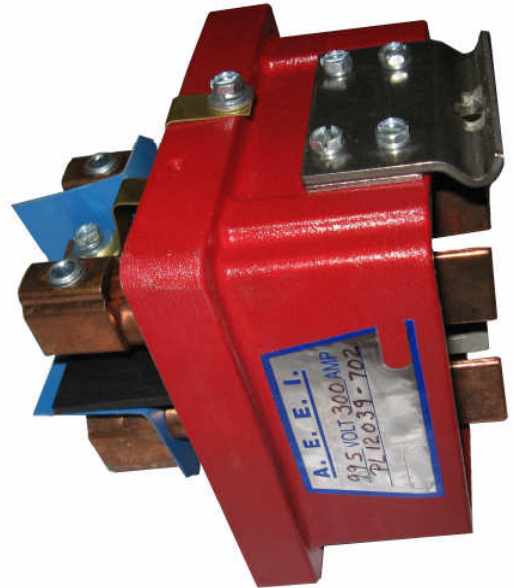
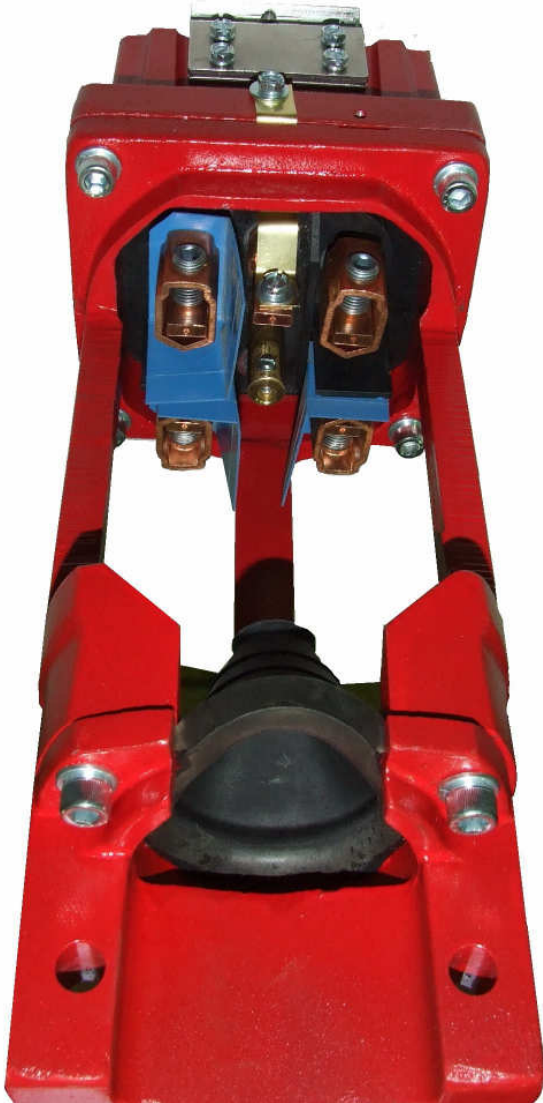

PIN ARRANGEMENT 300 AMP 995 VOLT

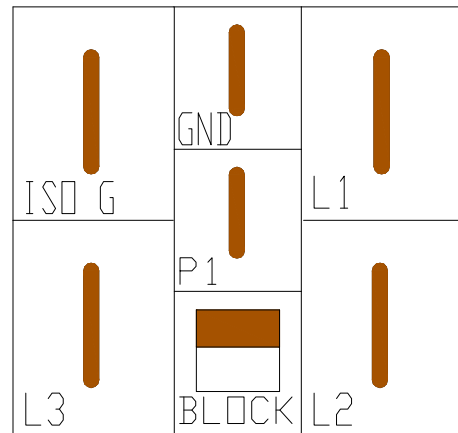

Lever Action Connectors

AEEI's low voltage figure 702 connectors are rugged, trouble free devices providing quick, confident connect/disconnect for portable mining equipment or self-propelled machinery. They are rated 300 Amperes at 995 VAC. Cable sizes range from #6 to 2/0 AWG.

Available Repair Parts List

Item	Quantity	Part	Description
1	1	10942-1	TOP PILOT BLADE ASSY.
2	1	2823-1	LOWER BLOCKING STUD
3	1	10941	L1 POWER BLADE ASSY.
4	4	10941-1	L2 - L3 POWER BLADE ASSY. GROUND
5	5	2064-1	5/8" ROTOR CLIP
6	2	2064-2	1/2" ROTOR CLIP
7	4	102-2	POWER AND GROUND TERMINAL
8	4	2694	7/16" x 3/4" NF SET SCREW
9	2	2069-2	3/16" x 1/4" HEX HEAD SLOTTED MACH. SCREW
10	4	2069-3	3/16" x 1/2" HEX HEAD SLOTTED MACH. SCREW
11	2	2067	3/16" FLATWASHER
12	6	2071	3/16" LOCK WASHER
13	8	12048	5/16" x 1" SOCKET HEAD CAP SCREW
14	8	2071-2	5/16" LOCK WASHER
15	2	2084-8	3/8" x 2 1/2" HEX HEAD CAP SCREW
16	2	2067-3	3/8" FLAT WASHER
17	2	2071-3	3/8" LOCK WASHER
18	2	2086	3/8" HEX NUT
19	1	063	WARNING NAME TAG
20	2	2072	1/8" x 1/4" NO.4 DRIVE SCREW
21	1	2084-5	1/4-20 x 1-1/2" HEX HEAD MACH. SCREW
22	1	2257	1/4-20 x 1/2" SLOTTED HEAD SET SCREW
23	1	2081-5	1/4" x 3/4" NC CAP. SCREW HEX HEAD
24	2	2067-1	1/4" FLAT WASHER
25	2	2071-1	1/4" LOCK WASHER
26	1	11366	TOP LATCH
27	1	11365	TOP LATCH SPACER
28	1	12049-2	GROUND STRAP
29	1	714	IDENTIFICATION STICKER
30	1	1672	GROMMET
31	1	2821-1	LOWER BLOCKING STUD INTERLOCK TUBING
32	2	582	RIGHT HAND TERMINAL INSULATOR
33	1	582-1	LEFT HAND TERMINAL INSULATOR
34	1	014-2	STRAIN CLAMP HALF
35	1	013-1	NUT STRAIN CLAMP
36	1	001-1	INSULATOR
37	1	11068	BASE
38	1	015-1	BELL HOUSING
39	1	016-1	BELL SLEEVE

Available Repair Kit

Part	Qty.	Description	Drawing
064-1-KIT		Top Latch Kit For 701 Plug	
		Parts Included In Kit	
	1	TOP LATCH	A-11366
	1	TOP LATCH SPACER	A-11365
	4	3/16" x 1/2" HEX HEAD SLOTTED MACH. SCREW	A-2069
	4	3/16" LOCK WASHER	A-2071

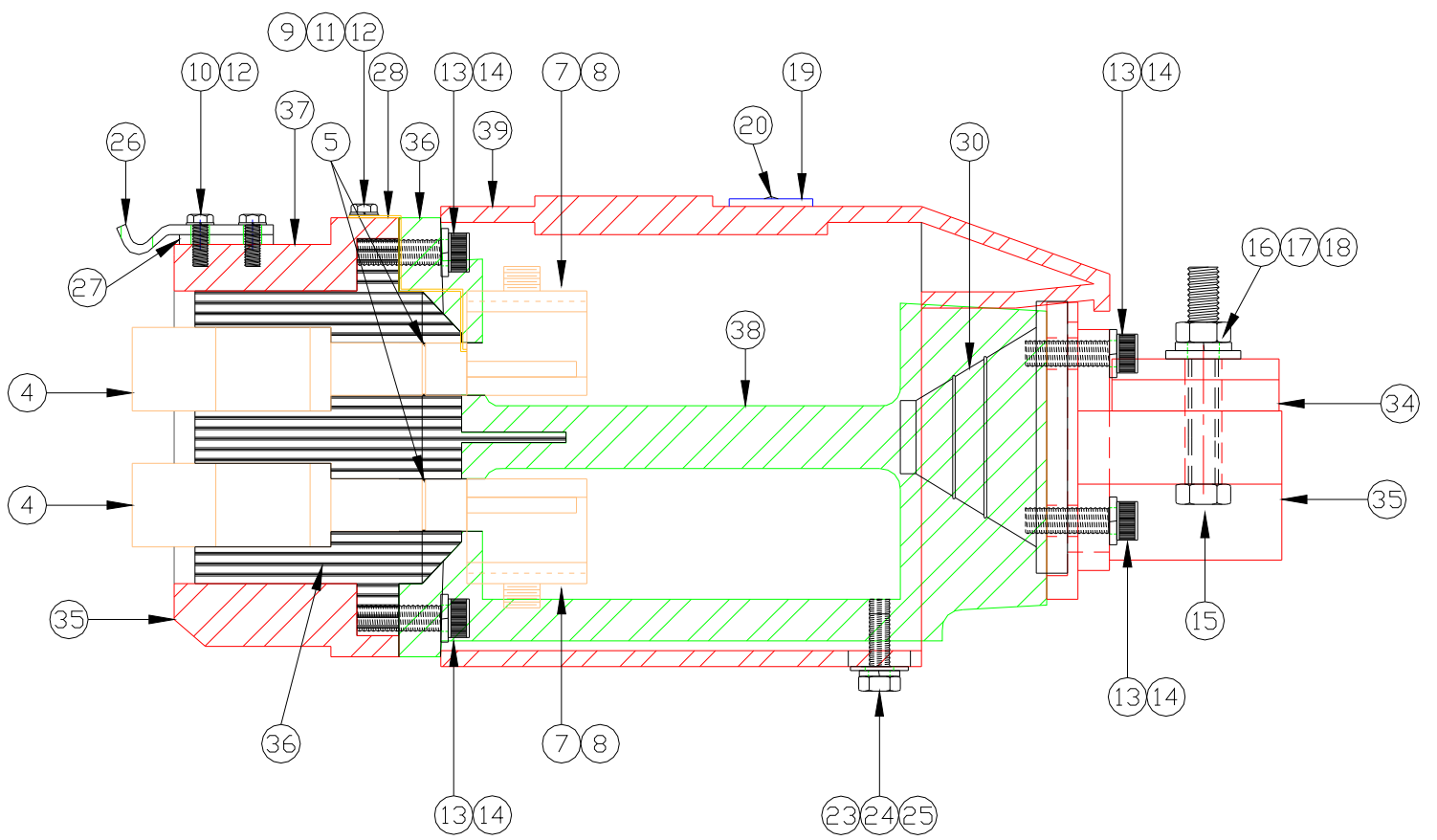
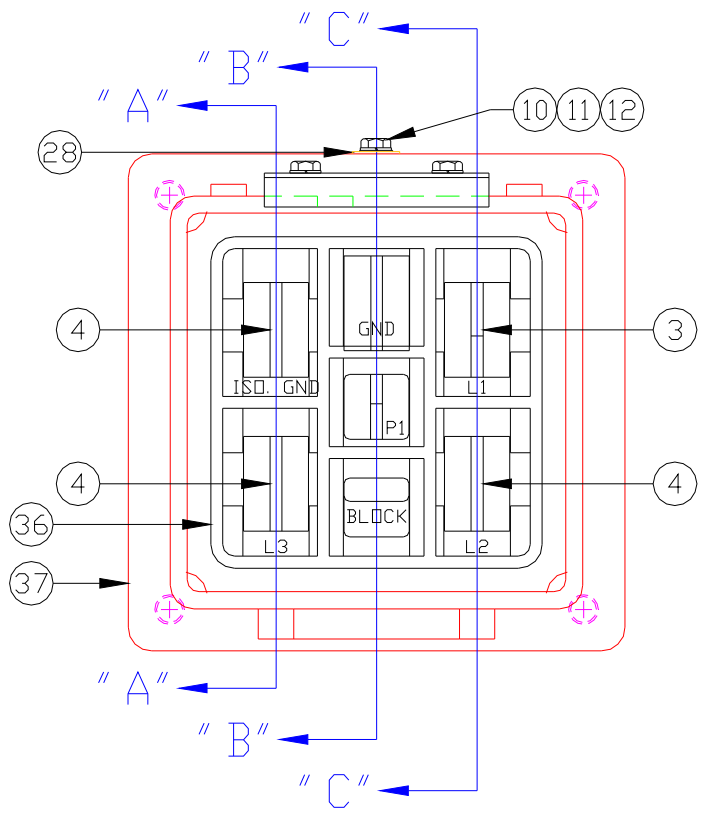

SECTION "A" - "A"

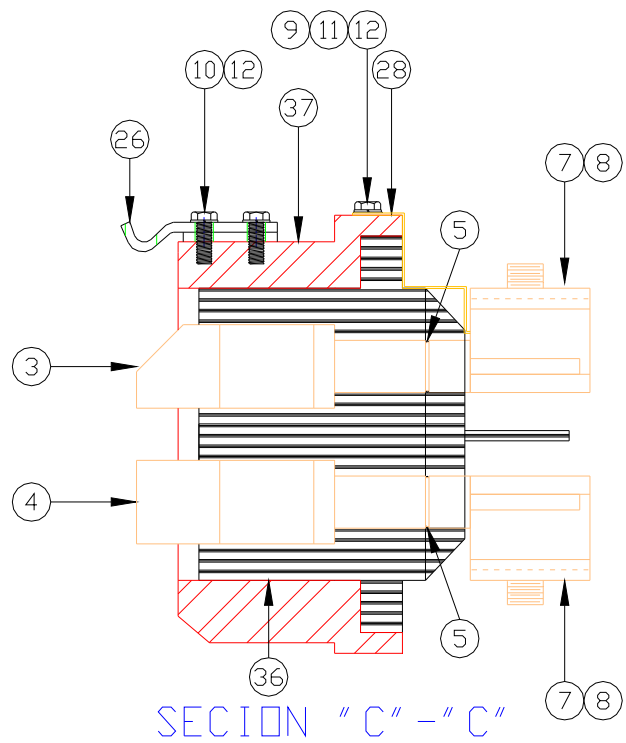
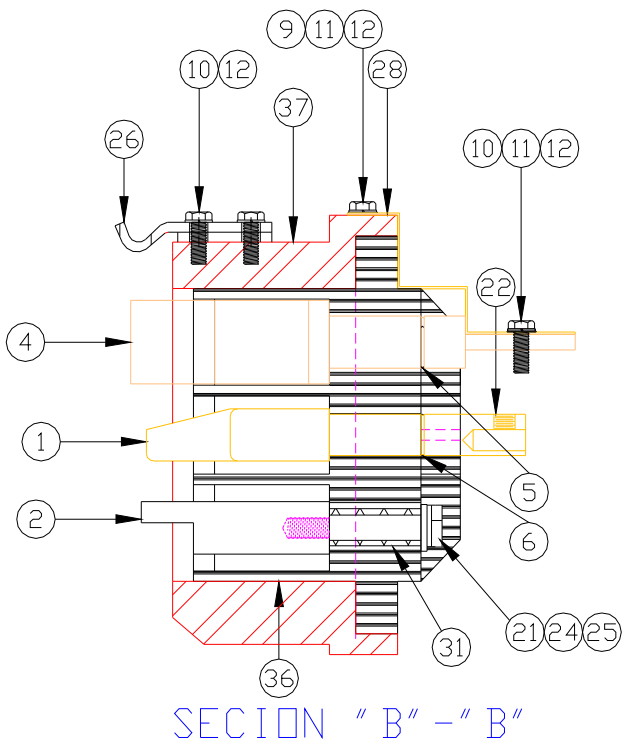

Features

- ✓ Single-piece, high grade insulator
- ✓ Aluminum housing
- ✓ Self-contained cable strain relief and cable grommet
- ✓ Fits both flat and round trailing cables
- ✓ All live exposed parts are completely enclosed by the metal housing
- ✓ Easy to remove sleeve for making cable terminations
- ✓ Minimum effort required to connect or disconnect electrical connections.
- ✓ The ground blade is always the last to break, first to make
- ✓ Ground check circuits make last, break first to insure phase connections are de-energized when connector opens
- ✓ Self-wiping contacts insure good electrical connections after each operation
- ✓ Interchangeable with other industry standard figure 701 plugs
- ✓ Removable ground strap for ground pin isolation