



Prices effective October 3, 2022

# Lino® Chairs

HermanMiller list prices shown are in USD. For HermanMiller Canadian prices, multiply the USD list price by a factor of 1.15---effective October 2022.

<b>Introduction</b>	<b>page 2</b>
<b>Lino® Chairs</b>	<b>3</b>
Work Seating	5
Stools	9
<b>Appendices</b>	
20-Day or Less/Assigned Lead-Time Order Information	
Casters and Glides	
Proprietary Textiles Application Chart-Seating	
Proprietary Textile Colors-Seating	
<b>For the latest materials information, refer to the Materials pages on HermanMiller.com.</b>	

# Introduction

## A Note on the Organization of This Book

There are a few signals that will help you understand the organization of this book. Once you know them, you should be able to find your way around easily.

### Like a newspaper, this book is formatted with columns of text and illustrations that run vertically.

Information wraps from one column to the next and continues for as many pages as it needs to.

### Black bars are clues.

A black bar at the top of a page signals the start of information about a product.

This information is divided into two sections, each signaled by a black bar. Product Information includes a description, additional notes, and dimensional drawings. Specification Information, which always begins at the top of a column, includes a series of steps. Each step represents a decision you need to make in order to complete your product number. Steps must be followed sequentially. The number of pages needed to complete information on a product varies; some will be complete in one page; others may fill three or four pages. Just continue going through the steps until you run into the next product, signaled by the black bar at the top of the page.

Black tabs running along the outside edge of the page help you locate what section you are in or what section you want to go to. You can thumb forwards or backwards to find a section; tabs and text appear on both sides of the page.

The additional pages in the back of the book include the appendices and indices. They are signaled by a long black bar running along the outside edge of the page.

### The index is presented two ways.

The first index is in alphabetical order by product name. It can be helpful if you are new to the products and numbering scheme or if you are looking for a type of product, such as work chair or round table.

The second index is by product number. It lists, in alphanumeric order, the base product number, typically a five-digit number.

## General Information

This book is effective October 3, 2022, subject to change without notice. Products may be purchased from authorized Herman Miller dealers who will quote prices upon request. For more information about our products and services or to see a list of dealers, visit [www.HermanMiller.com](http://www.HermanMiller.com).

All prices are list prices. Additional services, such as planning services, design, storage, and installation, are not included and must be added to these prices when the additional services are requested.

Illustrations, specifications, and prices are based on the latest information at the time of publication. The right is reserved to make changes at any time without notice in prices, fabrics, finishes, materials, specifications, and models, and also to discontinue models and finishes.

Dimensions shown in the drawings are engineering drawing dimensions rounded up to the nearest  $\frac{1}{8}$ ". Product is shipped set up or knocked down. Products that include "Shipped knocked down" in the description require some assembly. If this statement does not appear in the description, the product is shipped assembled.

Service problems are normally handled by a Herman Miller authorized dealer. Where this cannot be accomplished on a local level, service problems should be referred to the Customer Care Representative for your region, Herman Miller, Inc., Zeeland, Michigan 49464.

### 20-Day or Less/Assigned Lead-Time Shipments

All products and options in this price book not designated by an Assigned Program icon  will ship in **20 business days or less** after being acknowledged by Herman Miller.

Products and options designated by an  are on the assigned lead-time program and may ship in 20 days, less than 20 days, or more than 20 days from order acknowledgement.

**Work Seating**

**Stools**



Work Chair, Suspension Back - MI1B3 Assembled



**Product Information**

**Description**

This chair has an upholstered seat with Duo suspension back. It has a 5-star base and 2 pneumatic height adjustment options. Chair comes standard with passive sacral support and is available with optional adjustable lumbar support with sacral support. Back frame, 5-star base, arms, arm pads and tilt controls are offered in black as standard with the option of mineral. A polished aluminum 5-star base is an option with either black or mineral frame finish configuration. Tilt options include semi-synchronous with tilt limiter, synchronous with tilt limiter, and synchronous with tilt limiter and seat angle. All tilts have the option of fixed seat or an adjustable seat depth with 2 3/4" range. The tilt limiter allows the user to set the tilt range to limit the amount of recline.

The synchronous with tilt limiter and seat angle allows the user to set the tilt range and select a 5° forward seat angle

Arm choices include no arms, fixed arms, height-adjustable arms with 4" vertical range, and fully adjustable arms that adjust 4" vertically, 2" front to back, and 1 1/4" horizontally.

**Notes**

To order ready-to-assemble chair, order (MI2B3) separately.

Arms can be removed in the field.

For information on casters, see Casters and Glides in appendices.

Customer's Own Material (COM) on the seat requires 0.79 yards.

Customer's Own Leather (COL) on the seat requires 9.33 square feet.

See Order Information in appendices.

**Dimensions**

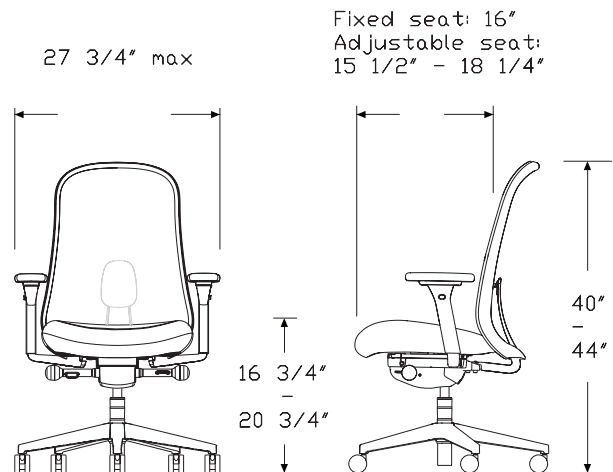

Standard height range

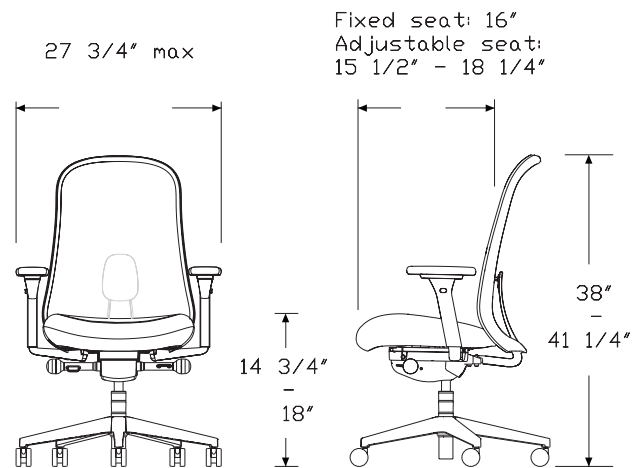

Low height range

# Work Chair, Suspension Back - Assembled *continued*

Lino® Work Seating

Specification Information		
Step 1.		
<b>MI1B3</b>		
Step 2. Height Adjustment		
<b>1</b>	low-height range	+\$807
<b>2</b>	standard-height range	+\$807
Step 3. Tilt		
<b>5</b>	semi synchronous with tilt limiter	+\$0
<b>6</b>	synchronous with tilt limiter	+\$45
<b>7</b>	synchronous with tilt limiter and seat angle	+\$88
Step 4. Arms		
<b>N</b>	no arms	+\$0
<b>P</b>	fixed arms	+\$115
<b>H</b>	height-adjustable arms	+\$131
<b>A</b>	fully adjustable arms	+\$218
Step 5. Seat-Depth Adjustment		
<b>F</b>	fixed seat depth	+\$0
<b>A</b>	adjustable seat depth	+\$117
Step 6. Back Support Option		
<b>N2</b>	no additional support	+\$0
<b>AJ</b>	adjustable lumbar with sacral support	+\$53
Step 7. Base/Frame Finish		
<b>BK</b>	black base/black frame	+\$0
<b>BKV</b>	black base/mineral frame	+\$55
<b>VPR</b>	mineral base/mineral frame	+\$60
<b>68</b>	polished aluminum base/black frame	+\$119
<b>PAM</b>	polished aluminum base/mineral frame	+\$179
Step 8. Casters		
<b>BB</b>	2½" hard caster, black yoke, carpet only	+\$0
<b>GF</b>	2½" glide, hard floors or carpet	+\$25
<b>C7</b>	2½" caster, black yoke, hard floors or carpet	+\$50
<b>C9</b>	2½" braking caster, black yoke, hard floors or carpet	+\$50
<b>SC8</b>	2½" caster, black yoke, hard floors or carpet with quiet roll technology	+\$50
Step 9. Duo Suspension Material		
	Price Category 4	+\$0
	Price Category 10	+\$0
	Price Category 1	+\$0

Step 10. Seat Fabric	
Price Category 1	+\$0
Price Category 2	+\$8
Price Category 3	+\$17
Price Category 4	+\$34
Price Category 5	+\$56
Price Category 7	+\$109
Price Category 8	+\$163
Price Category 9	+\$181
Price Category 10	+\$288
Price Category B	+\$31
Price Category C	+\$43
Price Category D	+\$55
Price Category E	+\$66
Price Category F	+\$85
Price Category G	+\$112
Price Category H	+\$134
Price Category I	+\$158
Price Category J	+\$182
Price Category L	+\$229

Work Chair, Suspension Back - MI2B3  
Ready to Assemble



**Product Information**

**Description**

This ready-to-assemble chair has an upholstered seat with Duo suspension back. It has a 5-star base and 2 pneumatic height adjustment options. Chair comes standard with passive sacral support and is available with optional adjustable lumbar support with sacral support. Back frame, 5-star base, arms, arm pads and tilt controls are offered in black as standard with the option of mineral. A polished aluminum 5-star base is an option with either black or mineral frame finish configuration.

Tilt options include semi-synchronous with tilt limiter, synchronous with tilt limiter, and synchronous with tilt limiter and seat angle. All tilts have the option of fixed seat or an adjustable seat depth with 2 3/4" range. The tilt limiter allows the user to set the tilt range to limit the amount of recline.

The synchronous with tilt limiter and seat angle allows the user to set the tilt range and select a 5° forward seat angle

Arm choices include no arms, fixed arms, height-adjustable arms with 4" vertical range, and fully adjustable arms that adjust 4" vertically, 2" front to back, and 1 1/4" horizontally.

**Notes**

To order assembled chair, order (MI1B3) separately.

Arms can be removed in the field.

For information on casters, see Casters and Glides in appendices.

Customer's Own Material (COM) on the seat requires 0.79 yards.

Customer's Own Leather (COL) on the seat requires 9.33 square feet.

See Order Information in appendices.

**Dimensions**

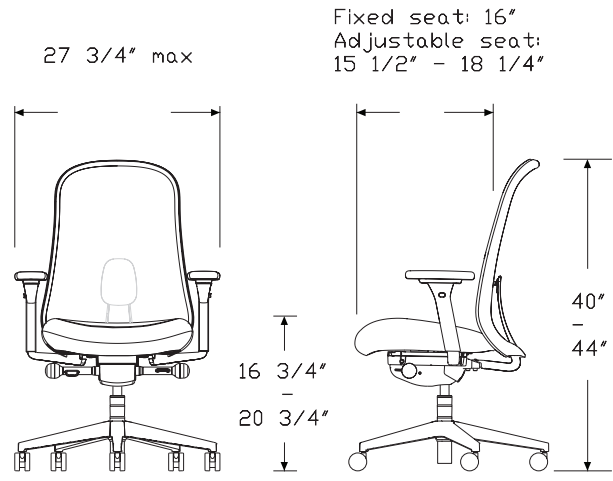

Standard height range

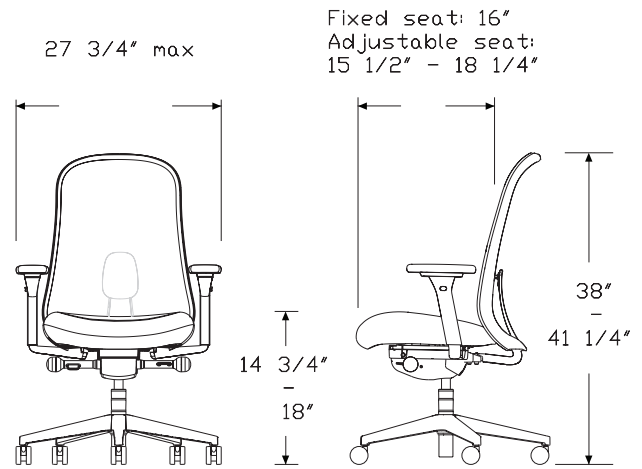

Low height range

# Work Chair, Suspension Back - Ready to Assemble *continued*

Lino® Work Seating

Specification Information		
Step 1.		
<b>MI2B3</b>		
Step 2. Height Adjustment		
<b>1</b>	low-height range	+\$721
<b>2</b>	standard-height range	+\$721
Step 3. Tilt		
<b>5</b>	semi synchronous with tilt limiter	+\$0
<b>6</b>	synchronous with tilt limiter	+\$45
<b>7</b>	synchronous with tilt limiter and seat angle	+\$88
Step 4. Arms		
<b>N</b>	no arms	+\$0
<b>P</b>	fixed arms	+\$115
<b>H</b>	height-adjustable arms	+\$131
<b>A</b>	fully adjustable arms	+\$218
Step 5. Seat-Depth Adjustment		
<b>F</b>	fixed seat depth	+\$0
<b>A</b>	adjustable seat depth	+\$117
Step 6. Back Support Option		
<b>N2</b>	no additional support	+\$0
<b>AJ</b>	adjustable lumbar with sacral support	+\$53
Step 7. Base/Frame Finish		
<b>BK</b>	black base/black frame	+\$0
<b>BKV</b>	black base/mineral frame	+\$55
<b>VPR</b>	mineral base/mineral frame	+\$60
<b>68</b>	polished aluminum base/black frame	+\$119
<b>PAM</b>	polished aluminum base/mineral frame	+\$179
Step 8. Casters		
<b>BB</b>	2½" hard caster, black yoke, carpet only	+\$0
<b>GF</b>	2½" glide, hard floors or carpet	+\$25
<b>C7</b>	2½" caster, black yoke, hard floors or carpet	+\$50
<b>C9</b>	2½" braking caster, black yoke, hard floors or carpet	+\$50
<b>SC8</b>	2½" caster, black yoke, hard floors or carpet with quiet roll technology	+\$50
Step 9. Duo Suspension Material		
	Price Category 4	+\$0
	Price Category 10	+\$0
	Price Category 1	+\$0

Step 10. Seat Fabric	
Price Category 1	+\$0
Price Category 2	+\$8
Price Category 3	+\$17
Price Category 4	+\$34
Price Category 5	+\$56
Price Category 7	+\$109
Price Category 8	+\$163
Price Category 9	+\$181
Price Category 10	+\$288
Price Category B	+\$31
Price Category C	+\$43
Price Category D	+\$55
Price Category E	+\$66
Price Category F	+\$85
Price Category G	+\$112
Price Category H	+\$134
Price Category I	+\$158
Price Category J	+\$182
Price Category L	+\$229



# Stool, Work, Suspension Back MI7B3



## Product Information

### Description

This stool has an upholstered seat with Duo suspension back. It has a 5-star base and pneumatic height adjustment. Stool comes standard with passive sacral support and is available with optional adjustable lumbar support with sacral support. Back frame, 5-star base, arms, arm pads and tilt controls are offered in black as standard with the option of mineral. A polished aluminum 5-star base is an option with either black or mineral frame finish configuration.

Tilt options include height adjustable and synchronous with tilt limiter. Height adjustable option does not recline. The synchronous with tilt limiter option allows the user to set the tilt range to limit the amount of recline.

Arm choices include no arms, fixed arms, height-adjustable arms with 4" vertical range, and fully adjustable arms that adjust 4" vertically, 2" front to back, and 1 1/4" horizontally.

### Notes

Arms can be removed in the field.

For information on casters, see Casters and Glides in appendices.

Customer's Own Material (COM) on the seat requires 0.79 yards.

Customer's Own Leather (COL) on the seat requires 9.33 square feet.

See Order Information in appendices.

### Dimensions

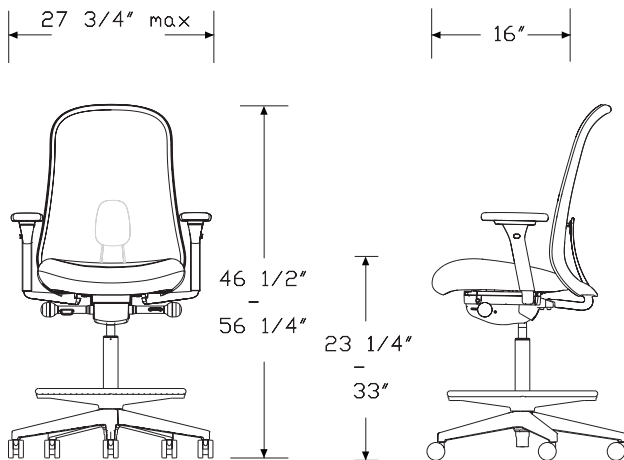

## Specification Information

### Step 1.

#### MI7B3

### Step 2. Height Adjustment

<b>1</b>	standard stool height	+\$962
----------	-----------------------	--------

### Step 3. Tilt

<b>5</b>	height adjustable	+\$0
<b>6</b>	synchronous with tilt limiter	+\$88

### Step 4. Arms

<b>N</b>	no arms	+\$0
<b>P</b>	fixed arms	+\$115
<b>H</b>	height-adjustable arms	+\$131
<b>A</b>	fully adjustable arms	+\$218

### Step 5. Seat Adjustment

<b>F</b>	fixed seat depth	+\$0
----------	------------------	------

### Step 6. Back Support Option

<b>N2</b>	no additional support	+\$0
<b>AJ</b>	adjustable lumbar with sacral support	+\$53

### Step 7. Base/Frame Finish

<b>BK</b>	black base/black frame	+\$0
<b>BKV</b>	black base/mineral frame	+\$55
<b>VPR</b>	mineral base/mineral frame	+\$60
<b>68</b>	polished aluminum base/black frame	+\$119
<b>PAM</b>	polished aluminum base/mineral frame	+\$179

### Step 8. Casters

<b>BB</b>	2 1/2" hard caster, black yoke, carpet only	+\$0
<b>GF</b>	2 1/2" glide, hard floors or carpet	+\$25
<b>C7</b>	2 1/2" caster, black yoke, hard floors or carpet	+\$50
<b>C9</b>	2 1/2" braking caster, black yoke, hard floors or carpet	+\$50
<b>SC8</b>	2 1/2" caster, black yoke, hard floors or carpet with quiet roll technology	+\$50

### Step 9. Duo Suspension Material

Price Category 4	+\$0
Price Category 10	+\$0
Price Category 1	+\$0

# Stool, Work, Suspension Back

*continued*

**Lino® Stools**



---

Step 10. Seat Fabric	
Price Category 1	+\$0
Price Category 2	+\$8
Price Category 3	+\$17
Price Category 4	+\$34
Price Category 5	+\$56
Price Category 7	+\$109
Price Category 8	+\$163
Price Category 9	+\$181
Price Category 10	+\$288
Price Category B	+\$31
Price Category C	+\$43
Price Category D	+\$55
Price Category E	+\$66
Price Category F	+\$85
Price Category G	+\$112
Price Category H	+\$134
Price Category I	+\$158
Price Category J	+\$182
Price Category L	+\$229

## 20-Day or Less/Assigned Lead-Time Order Information

### 20-Day or Less and Assigned Lead-Time Programs

20-day or less and assigned lead-time products are designed for established Herman Miller dealers with pre-approved credit.

Products are distributed from multiple manufacturing facilities across the United States. All products and options not designated by an Assigned Lead-Time icon  will ship in 20 business days or less after being acknowledged by Herman Miller. Products and options designated by an  are on the assigned lead-time program and will ship in 20 days, less than 20 days, or more than 20 days from order acknowledgement.

### Ordering Procedure

Please place orders through Order Manager. If this is not available to you, place orders through mail or fax. Verbal purchase orders will not be accepted.

Order Entry fax number for Meridian®

Filing and Storage: (616) 846 9236.

Order Entry fax number for all other products:

(616) 654 3085.

For more information, contact your Customer Care representative at:  
(866) 854 3048 ext 3400.

### Shipments and Delivery

Per Herman Miller Terms and Conditions.

### Changes and Cancellation

Per Herman Miller Terms and Conditions.



# Casters and Glides

▲	<b>WARNING</b>	▲
Depending on the floor surface, chair may unexpectedly roll away from user when entering or exiting the chair, possibly leading to unexpected injury. Please refer to descriptions of floor types when selecting casters.		

## 32 Caster

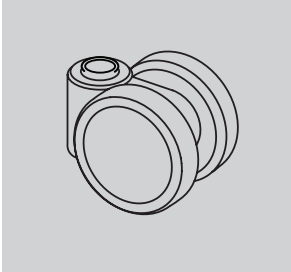

1<sup>7</sup>/<sub>8</sub>-inch-diameter hard double-wheel caster; black nylon wheels and yoke; for use on carpet only

Applicable on:  
Keyn Chairs  
Sayl® Chairs

## BB Caster

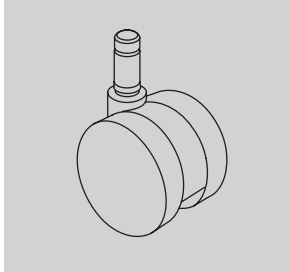

2<sup>1</sup>/<sub>2</sub>-inch-diameter hard double-wheel caster; black nylon wheels and yoke; for use on carpet only

Applicable on:  
New Aeron® Chairs  
Caper® Chairs  
Embody® Chairs  
Equa 2® Chairs  
Ergon 3® Chairs  
Lino™ Chairs  
Sayl Chairs  
Mirra® 2 Chairs  
Verus™ Chairs

## BSC Caster

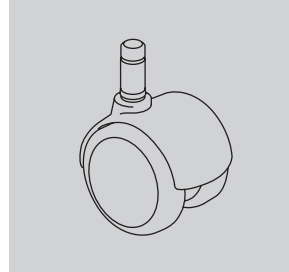

2-inch-diameter double-wheel caster; black nylon wheels and hood; soft polyurethane tread; for use on hard floors or carpet

Applicable on:  
Eames® Aluminum Group  
Eames Executive Chairs  
Eames Soft Pad Group  
Eames Task Chairs

## C9 Caster

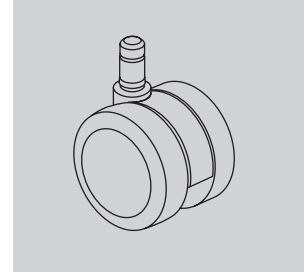

2<sup>1</sup>/<sub>2</sub>-inch-diameter double-wheel caster; black nylon wheels and yoke; soft polyurethane tread; internal brake; for use on hard floors or carpet

Applicable on:  
Caper Chairs  
Embody Chairs  
Equa 2 Chairs  
Ergon 3 Chairs  
Keyn Chairs  
Lino Chairs  
Mirra 2 Chairs  
Sayl Chairs  
Setu® Chairs  
Verus Chairs

## 49 Caster

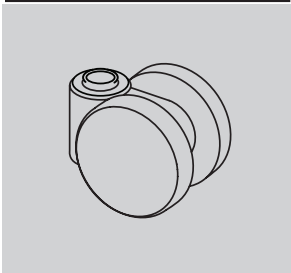

1<sup>7</sup>/<sub>8</sub>-inch-diameter soft double-wheel caster; black nylon wheels and yoke; for use on hard floors or carpet

Applicable on:  
Keyn Chairs  
Sayl Chairs

## BKS Caster

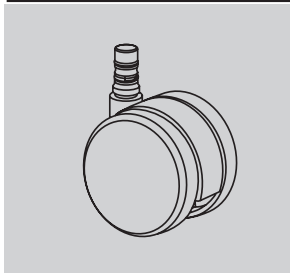

2<sup>1</sup>/<sub>2</sub>-inch-diameter hard double-wheel caster; black yoke; quiet roll technology; for use on carpet only

Applicable on:  
Cosm™ Chairs

## C7 Caster

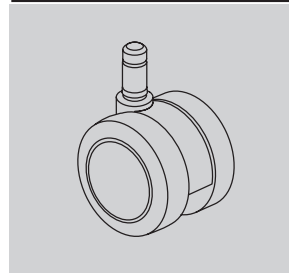

2<sup>1</sup>/<sub>2</sub>-inch-diameter double-wheel caster; black nylon wheels and yoke; soft polyurethane tread; for use on hard floors or carpet

Applicable on:  
New Aeron Chairs  
Caper Chairs  
Embody Chairs  
Equa 2 Chairs  
Ergon 3 Chairs  
Lino Chairs  
Mirra 2 Chairs  
Sayl Chairs  
Verus Chairs

## CSQ Caster

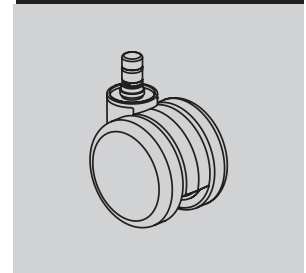

2<sup>1</sup>/<sub>2</sub>-inch-diameter double-wheel caster; color-matched nylon wheels and yoke; soft polyurethane tread; for use on hard floors or carpet

Applicable on:  
Zeph™ Chairs

# Casters and Glides

continued

**DC1 Caster**

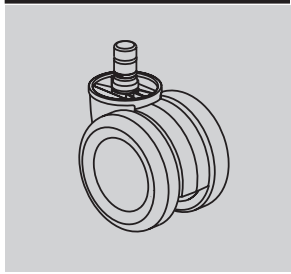

2<sup>1</sup>/<sub>2</sub>-inch-diameter double-wheel braking caster; black nylon wheels and yoke; for use on hard floors or carpet; quiet roll technology

Applicable on:  
New Aeron Chairs

**H9 Caster**

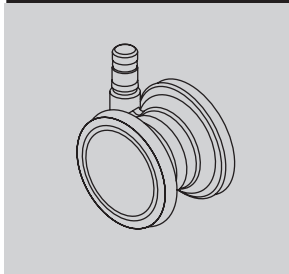

2<sup>1</sup>/<sub>2</sub>-inch-diameter double-wheel caster; clear polycarbonate wheels; nylon yoke; soft polyurethane tread; for use on carpet only

Applicable on:  
Embody Chairs  
Keyn Chairs

**HW Caster**

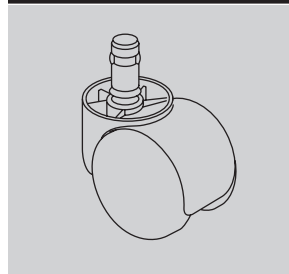

2-inch-diameter double-wheel caster; black nylon wheels and hood; for use on carpet only

Applicable on:  
Limerick® Cart

**O2 Caster**

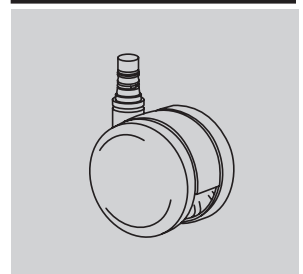

2<sup>1</sup>/<sub>2</sub>-inch-diameter double-wheel caster; nylon wheels and yoke; soft polyurethane tread; quiet roll technology; for use on hard floors or carpet

Applicable on:  
Cosm Chairs

**DS Caster**

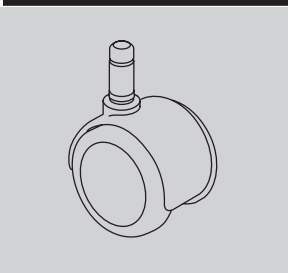

2-inch-diameter soft double-wheel braking caster; black nylon wheels and hood; for use on hard floors only

Applicable on:  
Aside® Chairs  
Caper Chairs

**HCC Caster**



2<sup>1</sup>/<sub>2</sub>-inch-diameter double-wheel low roll resistance caster; black yoke; for use on hard floors or carpet

Applicable on:  
Keyn Chairs  
Setu Chairs

**MD Caster**

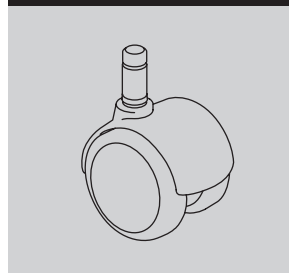

2-inch-diameter double-wheel caster; black nylon wheels with integral chrome hood; soft polyurethane tread; for use on hard floors or carpet

Applicable on:  
Eames® Aluminum Group  
Eames Executive Chairs  
Eames Soft Pad Group  
Eames Task Chairs

**OC Caster**



2<sup>1</sup>/<sub>2</sub>-inch-diameter double-wheel medium roll-resistant caster; black nylon wheels and yoke; soft polyurethane tread; for use on hard floors or carpet; quiet roll technology

Applicable on:  
Cosm Chairs  
Keyn Chairs  
Setu Chairs

# Casters and Glides

continued

**SC8 Caster**

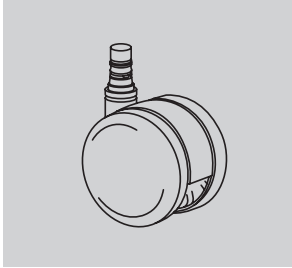

2<sup>1</sup>/<sub>2</sub>-inch-diameter double-wheel caster; black nylon wheels and yoke; soft polyurethane tread; quiet roll technology; for use on hard floors or carpet

Applicable on:  
Cosm Chairs  
Lino Chairs  
Mirra 2 Chairs  
Verus Chairs

**U4 Caster**

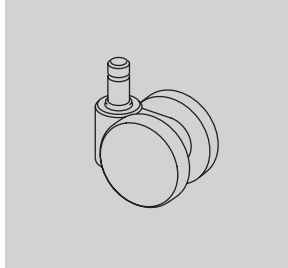

1<sup>7</sup>/<sub>8</sub>-inch-diameter hard double-wheel caster; black nylon wheels and yoke; for use on carpet only

Applicable on:  
Aside Chairs  
Verus Chairs

**UD Caster**

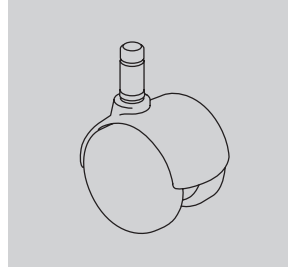

2-inch-diameter hard double-wheel caster; black nylon wheels with painted hood; for use on carpet only

Applicable on:  
Eames® Aluminum Group  
Eames Executive Chairs  
Eames Soft Pad Group  
Eames Task Chairs

**16 Glide**

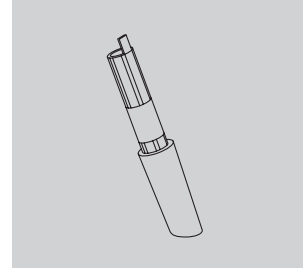

(Front glide shown)  
2<sup>1</sup>/<sub>8</sub>-inch-high glide; black or fog acetal; for use on carpet only

Applicable on:  
Sayl Chairs

**SW Caster**

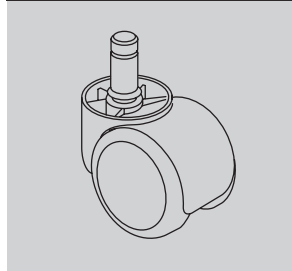

2-inch-diameter soft double-wheel caster; black nylon wheels and hood; for use on hard floors only

Applicable on:  
Limerick Cart

**U5 Caster**

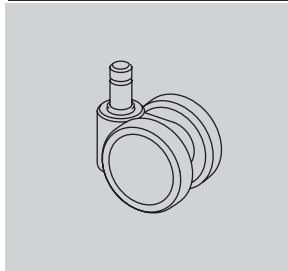

1<sup>7</sup>/<sub>8</sub>-inch-diameter soft double-wheel caster; black nylon wheels and yoke; for use on hard floors or carpet

Applicable on:  
Aside Chairs  
Caper Chairs  
Verus Chairs

**VD Caster**

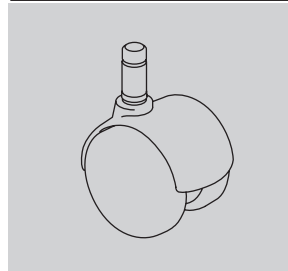

2-inch-diameter hard double-wheel caster; black nylon wheels with integral chrome hood; for use on carpet only

Applicable on:  
Eames Aluminum Group  
Eames Executive Chairs  
Eames Soft Pad Group  
Eames Task Chairs

**69 Glide**

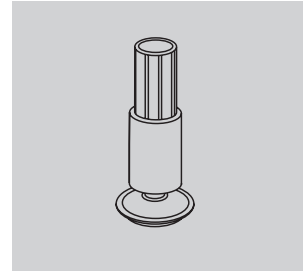

(Front glide shown)  
2<sup>1</sup>/<sub>8</sub>-inch-high glide; black glass-filled nylon stem; steel-plated swivel foot with Floor Saver Glide™ insert; for use on hard floors only

Applicable on:  
Sayl Chairs

# Casters and Glides

continued

**AGL Glide**

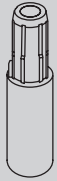

2<sup>1</sup>/<sub>4</sub>-inch-high glide; black or white nylon stem; for use on carpet only

Applicable on:  
Keyn Chairs

**G4 Glide**

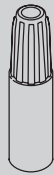

1<sup>7</sup>/<sub>8</sub>-inch-high glide; black acetal; for use on carpet only

Applicable on:  
Verus Chairs

**GF Glide**

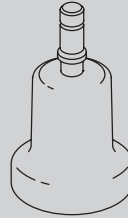

2<sup>1</sup>/<sub>2</sub>-inch-high glide; black nylon; for use on hard floors or carpet

Applicable on:  
New Aeron Chairs  
Caper Chairs  
Cosm Chairs  
Equa 2 Chairs  
Ergon 3 Chairs  
Lino Chairs  
Mirra 2 Chairs  
Sayl Chairs  
Verus Chairs

**GL Glide**

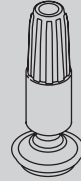

1<sup>7</sup>/<sub>8</sub>-inch-high glide; black nylon stem; steel-plated swivel foot with Floor Saver Glide™ insert; for use on hard floors only

Applicable on:  
Verus chairs

**FSG Glide**

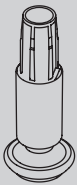

2<sup>1</sup>/<sub>4</sub>-inch-high glide; black or white nylon stem; steel-plated swivel foot with Floor Saver Glide™ insert; for use on hard floors only

Applicable on:  
Keyn Chairs

**GD Glide**



1<sup>1</sup>/<sub>2</sub>-inch-diameter glide; 1/2 inch in height; black nylon; for use on hard floors or carpet

Applicable on:  
Eames Aluminum Group  
Eames Executive Chairs  
Eames Soft Pad Group  
Eames Task Chairs

**GG Glide**

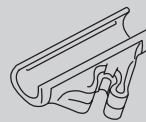

1/2-inch-high ganging glide; clear polycarbonate; for use on hard floors or carpet

Applicable on:  
Limerick Chairs  
Pronta Stacking Chairs

**HG Glide**



1/2-inch-high glide; black nylon glide with stainless-steel insert; for use on hard floors or carpet

Applicable on:  
Aside Chairs



# Casters and Glides

continued

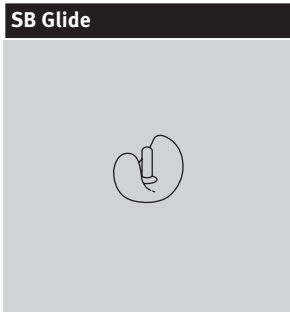

1/4-inch-high, 1-inch diameter glide; thermoplastic CAP material (G1 base has black glides; XT base has clear glides); for use on hard floors or carpet

Applicable on:  
Equa 2 Chairs



1/2-inch-high glide; clear polycarbonate; for use on hard floors or carpet

Applicable on:  
Limerick Chairs  
Pronta Stacking Chairs

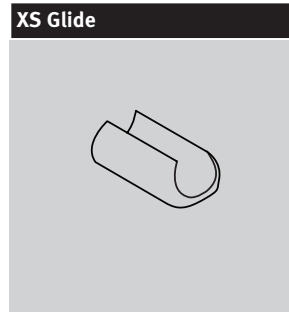

1/8-inch-high glide; polycarbonate in black, fog, clear, and studio white finishes; for use on hard floors or carpet

Applicable on:  
Sayl Chairs



1 7/8-inch-high glide; black nylon stem; steel-plated swivel foot with Floor Saver Glide™ insert; for use on hard floors only

Applicable on:  
Caper Chairs



1/2-inch-high glide; black nylon; for use on carpet only

Applicable on:  
Aside Chairs

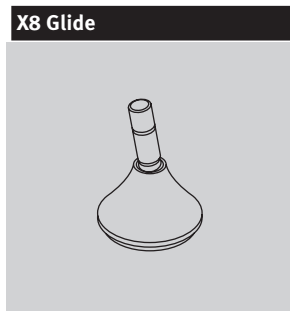

Glide; low profile; for use on hard floors or carpet

Applicable on:  
Setu Chairs



1 7/8-inch-high glide; black acetal; for use on carpet only

Applicable on:  
Caper Chairs



# Proprietary Textiles Application Chart — Seating

• Available

[A] Assigned lead-time textile.

[N] Non-woven textile.

See following page for exception notes.

## Price Category 1

Material	Aeron® Chairs	Cosm™ Chairs	Mirra® 2 Chairs/Stools	Embody® Chairs	Sayl® Work Chairs/Stools	Sayl Side Chairs	Setu® Chairs/Stools	Setu Lounge Chair/Ottoman	Zeph™ Chairs	Verus™ Work Chairs/Stools Back	Verus Work Chairs/Stools Seat	Verus Side Chairs Back	Verus Side Chairs Seat	Verus Plus Chairs	Aside® Chairs	Caper® Chairs/Stools	Keyn Chair Group Back	Keyn Chair Group Seat	Lino™ Chairs Back	Lino Chairs Seat	OE1 Storage Trolley Cushion Top	Public Office Landscape® Back	Public Office Landscape Seat	Plex® Lounge Furniture	Swoop™ Lounge Seating - Fully Upholstered	Swoop Lounge Seating - Plywood	Valor™ Seating	Nemschoff® Whisk™ Chairs	Eames® Tandem Sling Seating	Cushion Tops	Workspaces
COM Customer's Own Material [A]					1	1				1	1	1	1	1	1			1		1	1			1	1	1		1	1	1	1
231__ 8Z Pellicle®	•																														
1A7__ AireWeave™ 2			•																												
8T__ Crossing							•	•							•			•				•			•	•				•	•
3DE__ Dex					•	•	•			•	•	•	•	•	•			•				•		19	•		•			•	•
4RM__ Duo																			•												
6V__ Flexnet™																•															
95__ Gem							•	•							•							•			•	•				•	•
845__ Intercept			•																												
365__ Interweave 2										•		•																			
4W__ Lyris 2™							•	•																							
1MN__ Monologue					24	22	•	•		•	•	•	•				•	•		•	•	•	•	•	•	•	•	•	•	•	•
4SC__ Scatter					•	•	•			•	•	•	•	•	•		•	•		•	•	•	•	•	•	•	•	•	•	•	•
5H1__ Splash 3D Knit									•																						
3DK__ Stretch Knit [A]					21																										
235__ Tailored					•	•	•			•	•	•	•	•	•		•	•		•	•		•	23		•			7	•	
1WS__ Whisper					24	•	•	•		•	•	•	•	•	•		•	•		•	•		•	•	•	•	•	•	•	•	•

## Price Category 2

3AR__ Aristo					•	•	•	•		•	•	•	•	•	•		•	•		•	•	•	•	•	•	•	•	•	•	•	•
92__ Crepe					•	•	•	•		•	•	•	•	•	•		•	•		•	•	•	•	•	•	•	•	•	•	•	•
3EP__ Epic					•	•				•	•	•	•	•	•		•	•		•	•	•	•	•	•	•	•	•	•	•	•
1LM__ Loom					•	•				•	•	•	•	•	•		•	•		•	•	•	•	•	•	•	•	•	•	•	•
1MV__ Marvel [N]					21	22	•										•				•										
1HA__ Medley					•	•	22										•	•		•	•	•	•	•	•	•	•	•	•	•	•
4ME__ Mellow					•	22	•	•		•	•	•	•	•	•		•	•		•	•	•	•	•	•	•	•	•	•	•	•
30__ Rhythm					23	•	•			•	•	•	•	•	•		•	•		•	•	•	•	•	•	•	•	•	•	•	•
1RV__ Rivet					21	22											•	•		•	•	•	•	•	•	•	•	•	•	•	•
3SL__ Sequel [N]					•	•	•	•		•	•	•	•	•	•	8	•	•		•	•	•	•	•	•	•	•	•	•	•	•
4TE__ Terra					•	22				•	•	•	•	•	•		•	•		•	•	•	•	•	•	•	•	•	•	•	•
8R__ Twist					•	•	•	•		•	•	•	•	•	•		•	•		•	•	•	•	•	•	•	•	•	•	•	•

## Price Category 3

3AC__ Ace					21	•				•	•	•	•	•	8	•	•		•	•	•	•	•	19		•			•		
4LN__ Landing [N]																															
8M__ Latitude™					23	•	•																								
22V__ String Plaid					•	•				•	•	•	•	•	•		•	•		•	•	•	•	•	•	•	•	•	•	•	•

## Price Category 4

3DM__ Daydream					21	•	•	•		•		•	•	•			•		•	•	•		•	•	•				•	•	
1DL__ Dialogue																							•								
213__ Mercer					21	22				•	•	•	•	•			•	•		•	•	•	•	•	•	•	•	•	•	•	•
1A9__ Network																							•								
6S__ Quilty					•	•				•	•	•	•	•	•		•	•		•	•	•		•		•	•	•	•	•	•
22P__ Strata					•	•	•			•	•	•	•	•	•		•	•		•	•	•	•	•	•	•	•	•	•	•	•
3SY__ Sync					•	•	•	•		•	•	•	•	•	•		•	•		•	•	•	•	•	•	•	•	•	•	•	•

continued on next page

# Proprietary Textiles Application Chart — Seating continued

• Available

[A] Assigned lead-time textile.

[N] Non-woven textile.

See below for exception notes.

	Aeron® Chairs	Cosm™ Chairs	Mirra® 2 Chairs/Stools	Embody® Chairs	Sayl® Work Chairs/Stools	Sayl Side Chairs	Setu® Chairs/Stools	Setu Lounge Chair/Ottoman	Zeph™ Chairs	Verus™ Work Chairs/Stools Back	Verus Work Chairs/Stools Seat	Verus Side Chairs Back	Verus Side Chairs Seat	Verus Plus Chairs	Aside® Chairs	Caper® Chairs/Stools	Keyn Chair Group Back	Keyn Chair Group Seat	Lino™ Chairs Back	Lino Chairs Seat	OE1 Storage Trolley Cushion Top	Public Office Landscape® Back	Public Office Landscape Seat	Plex® Lounge Furniture	Swoop™ Lounge Seating - Fully Upholstered	Swoop Lounge Seating - Plywood	Valor™ Seating	Nemschoff® Whisk™ Chairs	Eames® Tandem Sling Seating	Cushion Tops	Workspaces		
<b>Price Category 5</b>																																	
3CY__Cozy					•	•	•	•		•	•	•	•	•	•		•	•		•				•	•	•	•	•			•		
14A__Hopsak					•	•	•	•		•	•	•	•	•	•		•	•		•		•		•	•	•	•	•			•		•
3SU__Summit [N]					•	•				•	•	•	•	•						•				•	•	•	•	•			•		•
<b>Price Category 6</b>																																	
35__Balance				•																													
<b>Price Category 7</b>																																	
COL Customer's Own Leather [A]	1														8						1											1	
<b>Price Category 8</b>																																	
No fabrics available at this time																																	
<b>Price Category 9</b>																																	
21__Leather [N]	23													8						•	•					•					•		

Application Note: Herman Miller cannot guarantee material/pattern alignment in adjacent products. For example, a fabric's pattern may not align from one pedestal cushion top to the next, or from one chair to another.

- 1 Refer to price book appendices and Omni for COM/COL information.
- 7 Available on 1" Cushion Tops only.
- 8 Only available on the Aside nonupholstered outer back option (PB).
- 9 Available on Valor upholstered seat only.
- 19 Available on Plex seat only.
- 21 Not available on Sayl upholstered back work chairs.
- 22 Not available on Sayl side chairs with upholstered backs.
- 23 Available in select colors. Refer to "Proprietary Textile Colors-Seating" for color offering.
- 24 Not available on Sayl upholstered High-Back Work Chairs.
- 25 Not available on Sayl side chairs with upholstered backs. Available in select colors. Refer to "Proprietary Textile Colors-Seating" for color offering.

# Proprietary Textile Colors — Seating

## Price Category 1

### Customer's Own Material

See Order Information in Appendices.  
Assigned lead-time textile. A

### 8Z Pellicle®

For New Aeron® Chairs  
56% elastomeric  
44% polyester

23101 Mineral  
23102 Carbon  
23103 Graphite

### AireWeave™ 2

For Mirra® 2 Chairs  
67% elastomeric  
33% antimony-free polyester

1A701 Alpine  
1A702 Slate Grey  
1A703 Graphite  
1A704 Lime Green  
1A705 Cappuccino  
1A706 Urban Orange  
1A707 Dark Turquoise  
1A708 Twilight

### Crossing

54" wide  
86% antimony-free polyester  
14% polyester

8T03 Wicker  
8T04 Porcelain  
8T05 Warm Grey  
8T10 Tomato  
8T13 Green Apple  
8T16 Periwinkle  
8T17 Cerulean  
8T18 Indigo  
8T19 Shale  
8T22 Tin  
8T23 Graphite  
8T24 Black

### Dex

54" wide  
50% recycled polyester  
50% polyester

3DE01 Frost  
3DE02 Silver Pine  
3DE03 Stone  
3DE04 Shale  
3DE05 Charcoal

### Duo

For Lino™ Chairs  
52% polyester  
48% elastomeric

4RM01 Mineral  
4RM02 Poppy  
4RM03 Green Leaf  
4RM04 Jade  
4RM05 Shadow  
4RM06 Graphite

### Flexnet™

For Caper® Chairs  
69% elastomeric  
31% polyester

6V01 Black  
6V02 Silver Grey

### Gem

54" wide  
100% antimony-free polyester

9502 Tangerine  
9503 Red  
9507 Twilight  
9508 Bayou  
9510 Berry Blue  
9511 Aqua Green  
9512 Green Apple  
9514 Black  
9515 Slate Grey  
9516 Fog

### Intercept

For Cosm™ Chairs  
60% elastomeric  
40% polyester

84501 Graphite  
84502 Carbon  
84503 Mineral  
84504 Nightfall  
84505 Glacier  
84506 Canyon

### Interweave 2

For Verus™ Chairs  
65% elastomeric  
35% polyester

36501 Iceberg  
36502 Poppy  
36503 Beachglass  
36504 Blue Grotto  
36505 Slate  
36506 Shale

### Lyris 2™

For Setu® Chairs  
74% elastomeric  
26% polyester

4W21 Alpine  
4W22 Mango  
4W23 Chartreuse  
4W25 Berry Blue  
4W26 Slate Grey  
4W28 Chino  
4W29 Rattan  
4W30 Java  
4W31 Graphite

### Monologue

54" wide  
56% recycled polyester  
44% polyester

1MN01 Linen  
1MN02 Alabaster  
1MN03 Truffle  
1MN04 Folkstone  
1MN05 Silver Pine  
1MN06 Slate  
1MN07 Seed  
1MN08 Yellow Oxide  
1MN09 Persimmon  
1MN10 Tundra  
1MN11 Meadow  
1MN12 Blue Sky  
1MN13 Blue Spruce  
1MN14 Deep Sea

### Scatter

54" wide  
100% recycled polyester,  
with 26% ocean bound plastic

4SC01 Alpine  
4SC02 Fog  
4SC03 Shale  
4SC04 Persimmon  
4SC05 Red Violet  
4SC06 Lime Zest  
4SC07 Olive  
4SC08 Glacier  
4SC09 Blue Sky  
4SC10 Lagoon  
4SC11 Slate Grey  
4SC12 Blue Black

Price category 1 continued on next page

# Proprietary Textile Colors — Seating

continued

## Price Category 1

continued

Appendix: Proprietary Textile Colors — Seating

### Splash 3D Knit

Available only on Zeph™ Chairs.  
knit to size  
54% post-consumer recycled polyester  
44% polyester  
2% lycra

5H101	Black
5H102	Carbon
5H103	Alpine
5H104	Silt
5H105	Tea Rose
5H106	Cocoa
5H107	Persimmon
5H108	Blaze
5H109	Cayenne
5H110	Falcon
5H111	Mustard Seed
5H112	Patina
5H113	Olive
5H114	Moss
5H115	Aloe
5H116	Glacier
5H117	Ultramarine
5H118	Nightfall
5H119	Bluebell
5H120	Boysenberry

### Stretch Knit

Assigned lead-time textile. A

Available only on Sayl®  
Suspension Back Work Chairs  
97% polyester, 3% spandex

3DK01	Fog
3DK02	Slate Grey
3DK03	Java
3DK04	Black
3DK05	Red
3DK06	Green Apple
3DK07	Berry Blue

### Tailored

54" wide  
56% polyester  
44% recycled polyester

23501	Studio White *
23502	Sugar *
23503	Tomato
23504	Orchid
23505	Boysenberry
23506	Chive
23507	Bluegrass
23508	Cobalt
23509	Cadet
23510	Fog
23511	Graphite
23512	Black
23513	Coffee

\* Colors not available on  
Plex™ Lounge Furniture.

### Whisper

54" wide  
73% recycled polyester  
27% polyester  
with 11.3% ocean bound plastic

1WS01	Sand Dollar
1WS02	Pebble
1WS03	Silver Birch
1WS04	Iceberg
1WS05	Silver Pine
1WS06	Carbon
1WS07	Cumin
1WS08	Adobe
1WS09	Strawberry
1WS10	Blush
1WS11	Eggplant
1WS12	Willow
1WS13	Sea Grass
1WS14	Pool
1WS15	Blueberry
1WS16	Glacier
1WS17	Grey
1WS18	Canyon

## Price Category 2

### Aristo

54" wide  
88% recycled polyester  
12% polyester  
Acrylic backing

3AR01	Forest Moss
3AR02	Light Brindle
3AR03	Mink
3AR04	Copper
3AR05	Adobe
3AR06	Cherry
3AR07	Lilac
3AR08	Green Apple
3AR09	Surf
3AR10	Waterfall
3AR11	Cadet
3AR12	Tin
3AR13	Pewter
3AR14	Grey Brindle
3AR15	Grey Black

### Crepe

54" wide  
100% recycled polyester,  
with 43.6% ocean bound plastic

9201	Licorice
9203	Smoke
9207	Cherry
9223	Cadet
9241	Beachglass
9249	Stone
9251	Fog
9252	Slate Grey
9261	Shale
9262	Graphite
9265	Mineral
9266	Persimmon
9267	Juniper
9268	Glacier
9269	Cascade
9270	Navy

### Epic

54" wide  
56% recycled polyester  
44% polyester  
Acrylic backing

3EP01	Alabaster
3EP02	Smoke
3EP03	Falcon
3EP04	Citrus Spring
3EP05	Copper
3EP06	Urban Orange
3EP07	Poppy
3EP08	Wild Plum
3EP09	Sugar Plum
3EP10	Clover
3EP11	Loden
3EP12	Everglade
3EP13	Mist
3EP14	Peacock
3EP15	Cadet
3EP16	Indigo
3EP17	Spring Wood
3EP18	Grey Brindle
3EP19	Seed
3EP20	Carbon Dark

### Loom

54" wide  
100% polyester

1LM01	Linen *
1LM02	Brown Sugar and Spice
1LM03	Brick and Mortar
1LM04	Salt and Pepper
1LM05	Black
1LM06	Lemongrass
1LM08	Wild Berry
1LM09	Loden
1LM10	Jade
1LM11	Deep Sea

\* Color not available on  
Valor™ Seating

Price category 2 continued on  
next page

# Proprietary Textile Colors — Seating

continued

## Price Category 2

continued

### Marvel

54" wide	
100% pvc-free polyurethane	
1MV01	Summer White
1MV02	Sand Dollar
1MV03	Espresso
1MV04	Folkstone Grey
1MV05	Graphite
1MV06	Onyx
1MV07	Polar Blue
1MV08	Blush Grey
1MV09	Woodrose
1MV10	Citrus
1MV11	Adobe
1MV12	Red
1MV13	Kiwi Green
1MV14	Pine
1MV15	Teal Green
1MV16	Twilight

### Medley

54" wide	
100% polyester	
1HA01	Stone
1HA02	Trail
1HA03	Charcoal
1HA04	Cinder
1HA05	Citrus
1HA06	Papaya
1HA07	Chutney
1HA08	Tundra
1HA09	Feather Grey
1HA10	Chartreuse
1HA11	Loden
1HA12	Peacock
1HA13	Bayou
1HA14	Blue Grotto
1HA15	Blueberry
1HA22	Khaki
1HA23	Pewter
1HA24	Yellow Oxide
1HA25	Vintage Rose
1HA26	Raspberry
1HA27	Acai Berry

### Mellow

54" wide	
100% recycled polyester, with 16% ocean bound plastic	
4ME01	Mineral
4ME02	Pewter
4ME03	Wisteria
4ME04	Olive
4ME05	Glacier
4ME06	Oceanside
4ME07	Charcoal

### Rhythm

54" wide	
100% polyester	
3001	Kiwi Green *
3002	Green Apple *
3003	Peacock *
3004	Bayou *
3005	Berry Blue
3006	Iris *
3007	Twilight
3008	Pumpkin *
3009	Poppy *
3010	Molasses *
3011	Mulberry *
3012	Khaki *
3013	Mink *
3014	Black
3015	Charcoal

\* Colors not available on Embody® Chair.

### Rivet

54" wide	
100% recycled polyester	
1RV01	Twig
1RV02	Deep Clay
1RV03	Woodrose
1RV04	Otter
1RV05	Hemlock
1RV06	Olive
1RV07	Lagoon
1RV08	Deep Sea
1RV09	Charcoal
1RV10	Grey Brindle

### Sequel

54" wide	
100% vinyl	
100% polyester knit backing	
Resilience® finish	
3SL01	White
3SL02	Pebble
3SL03	Mushroom
3SL04	Stone
3SL05	Chestnut
3SL06	Rattan
3SL07	Black Cherry
3SL08	Tundra
3SL09	Seal
3SL10	Blue Fog
3SL11	Folkstone
3SL12	Shale
3SL13	Slate Grey
3SL14	Charcoal
3SL15	Carbon Dark
3SL28	Navy *

\* Color available on Eames® Tandem Sling Seating.

### Terra

54" wide	
100% post-consumer recycled biodegradable polyester *	
4TE01	Spring Wood
4TE02	Zinc
4TE03	Pine Cone
4TE04	Charcoal

\* 1% biodegradation in 1,278 days under ASTM D5511 conditions. No evidence of further degradation.

### Twist

54" wide	
80% antimony-free polyester	
13% recycled polyester	
7% polyester	
8R05	Wicker
8R10	Poppy
8R14	Tin
8R15	Shale
8R16	Graphite
8R17	Birch
8R18	Sepia
8R22	Blueberry
8R23	Green Apple
8R26	Gunmetal
8R27	Cinder
8R28	Citrus
8R29	Pekoe
8R30	Tangerine
8R31	Red Plum
8R32	Wisteria
8R33	Forest
8R34	Jade Dark
8R35	Waterfall
8R36	Midnight Blue
8R37	Carbon Dark

# Proprietary Textile Colors — Seating

continued

## Price Category 3

Ace	
54" wide	
100% polyurethane	
Polyester knit backing	
Stain resistant finish	
3AC01	Summer White
3AC02	White Ash
3AC03	Rye
3AC04	Metal
3AC05	Clay
3AC06	Chestnut
3AC07	Citrus
3AC08	Camelback
3AC09	Chipotle
3AC10	Claret
3AC11	Slate Purple
3AC12	Artichoke
3AC13	Sepia Dark
3AC14	Aloe
3AC15	Flint
3AC16	Blue Sky
3AC17	Oceanside
3AC18	Midnight
3AC19	Spring Wood
3AC20	Frost
3AC21	Lead
3AC22	Black

Landing	
For Eames® Tandem Sling Seating	
54" wide	
100% TPE	
Polyester knit backing	
4LN01	Black

Latitude™	
61" wide	
100% polyester	
8M01	Graphite
8M02	Shadow
8M10	Alpine
8M17	Black
8M21	Slate Grey
8M22	Lime Green
8M23	French Press
8M24	Urban Orange
8M25	Dark Turquoise
8M26	Twilight

Latitude	
Colors for Mirra 2 Chairs	
100% polyester	
8M10	Alpine
8M17	Black
8M21	Slate Grey
8M22	Lime Green
8M23	French Press
8M24	Urban Orange
8M25	Dark Turquoise
8M26	Twilight

String Plaid	
54" wide	
100% recycled polyester	
22V01	Warm White on Khaki
22V02	Mint on Yellow Green
22V03	Mist on Blue Grey
22V04	Sky Blue on Red
22V05	Lime on Magenta
22V06	Bright Green on Green
22V07	Aqua Blue on Cerulean
22V08	Ivory on Black

## Price Category 4

Daydream	
54" wide	
48% wool	
41% recycled polyester	
9% nylon	
2% polyester	
3DM01	Rye Grass
3DM02	Silver Birch
3DM03	Pewter
3DM04	Graphite
3DM05	Black
3DM06	Lemongrass
3DM07	Permission
3DM08	Juniper
3DM09	Sea Grass
3DM10	Nightfall

Dialogue	
For Public Office Landscape®	
Sectional Back/Social Chair Back	
knit to size	
100% polyester	
1DL01	Light Brindle
1DL02	Dark Brindle

Mercer	
54" wide	
50% solution dyed recycled nylon	
50% solution dyed nylon	
BLOCKaide	
21301	Stone
21303	Cayenne
21305	Pesto
21306	Teal Blue
21307	Ultramarine
21310	Charcoal

Network	
For Public Office Landscape®	
Sectional Back/Social Chair Back	
knit to size	
100% polyester	
1A901	Warm White
1A902	Fog
1A903	Red
1A904	Wildberry
1A905	Green Apple
1A906	Twilight
1A907	Graphite

Quilty	
56" wide	
100% antimony-free polyester	
GreenShield	
6S03	Khaki
6S04	Straw
6S07	Brick
6S10	Mink
6S11	Green Apple
6S13	Indigo
6S14	Zinc
6S15	Slate
6S16	Beachwood
6S17	Paprika
6S18	Plum
6S19	Juniper
6S20	Grey Black

Price category 4 continued on next page



# Proprietary Textile Colors — Seating

continued

## Price Category 4

continued

Strata	
54" wide	
50% solution dyed recycled nylon	
50% solution dyed nylon	
BLOCKaide	
22P04	Pesto
22P05	Peacock
22P06	Blue Jay
22P07	Blueberry
22P09	Mango
22P10	Paprika
22P12	Wheat
22P13	Brownstone
22P14	Bayou

Sync	
55" wide	
100% polyester	
3SY01	Pine Cone
3SY02	Citron
3SY03	Canyon
3SY04	Truffle
3SY05	Wild Berry
3SY06	Everglade
3SY07	Glacier
3SY08	Nightfall
3SY09	Dark Mineral
3SY10	Slate Grey
3SY11	Dark Carbon
3SY12	Black

## Price Category 5

Cozy	
54" wide	
100% wool	
3CY01	Heathered Warm Grey
3CY02	Heathered Rye Grass
3CY03	Heathered Cool Grey
3CY04	Heathered Blue Grey
3CY05	Heathered Black
3CY06	Heathered Persimmon
3CY07	Heathered Loden
3CY08	Heathered Jade
3CY09	Heathered Lagoon
3CY10	Heathered Twilight

Hopsak	
56" wide	
100% recycled polyester	
14A20	Black
14A22	Raw Umber Dark
14A26	Grey Blue Dark
14A30	Sepia Dark
14A38	Emerald Dark
14A39	Yellow Dark
14A40	Orange
14A41	Sienna
14A42	Olive Green Dark
14A43	Crimson
14A44	Crimson Dark Dark
14A45	Violet Dark
14A46	Pink Dark Dark
14A47	Ultramarine Dark
14A48	Cobalt Blue
14A49	Terra Cotta
14A50	Ochre Dark

Summit	
54" wide	
100% silicone	
Polyester knit backing	
3SU01	Bright White
3SU02	Oyster
3SU03	Zinc
3SU04	Sparrow
3SU05	Taupe
3SU06	Java
3SU07	Black
3SU08	Cherry
3SU09	Beachglass
3SU10	Midnight

## Price Category 6

Balance	
For Embody® chairs	
100% polyester	
3512	Carbon
3513	Black

Appendix: Proprietary Textile Colors — Seating

# Proprietary Textile Colors — Seating

continued

---

## Price Category 7

**Customer's Own Leather**  
See Order Information in Appendices. Assigned lead-time textile. A

---

## Price Category 8

No fabrics available at this time.

---

## Price Category 9

<b>Leather</b>	
approx. 50 sq. ft. per hide	
100% leather	
2101	Ivory
2109	Black *
2110	Smoke
2111	Graphite
2112	Khaki
2113	Rattan
2114	Truffle
2115	Alpine
2116	Haze
2117	Sable Grey
2118	Dark Mineral **
2119	Dark Carbon ***
2120	Cranberry
2121	Deep Sea

\* Armpad color available on Aeron® Chair, Graphite.

\*\* Armpad color available on Aeron Chair, Mineral.

\*\*\* Armpad color available on Aeron Chair, Carbon.



For more information about our products and services or to see a list of dealers, please visit us at [HermanMiller.com](http://HermanMiller.com) or call (800) 851 1196.

© 2022 Herman Miller, Inc., Zeeland, Michigan

#### Distribution Rights

Working together since 1956, Herman Miller and Vitra are the authentic sources of designs by Charles and Ray Eames, Alexander Girard, and George Nelson. All the designs shown in this book are protected by law. Herman Miller has obtained all rights to make and sell these designs. Also, Herman Miller holds exclusive worldwide manufacturing and distribution rights for these products with the following exceptions:

Charles and Ray Eames, George Nelson, and Alexander Girard—Worldwide distribution rights for furniture in all areas except Europe and the Middle East. For those areas, please contact Vitra.

Isamu Noguchi—Worldwide distribution rights for the Noguchi Rudder Table. Distribution rights for the Noguchi Table in North America and Central America only. For all other areas, please contact Vitra.

Magis—Exclusive distribution rights in the US and Canada. For all other areas, please contact Magis.

© HermanMiller, 3D Intelligent, AO, Action Office, Aeron, ArcSpan, Aside, Avall, Bubble Lamps, Canvas Office Landscape, Caper, Celle, Cosm, Co/Struc, Daisyone, Distil, Eames, Eco-Dematerialized, Embody, Envelop, Ethospace, Exclave, Fine-Tune, FlexFront, Flo, Formcoat, Formwork, Ground Cloth, Herman Miller for the Home, Herman Miller for Healthcare, Intersect, Kinemat, Layout Studio, Lifework, Limerick, Lino, Live Unframed, Living Office, Maharam, Meridian, Mirra, Motia, Nelson, Pellicle, Perspectives, Plex, PostureFit, PostureFit SL, Prospects, Public Office Landscape, Resolve, Rodney, Sayl, Setu, Tu, Ubi, Verus, Wishbone, and Y-Tower are among the registered trademarks of Herman Miller, Inc., and its owned subsidiaries.

8Z Pellicle, About Face, AireWeave, Albert, Ambit, Backfit, Bublestack, Burdick Group, Butterfly Back, Cellular Suspension, Clam, Commend, Compass, Connect, DOT, Duracare, Durawrap, EnhancedAccess, Everywhere, Flex-Edge, Flute, Harmonic, Headway, Herman Miller Select, Hopsak 2, Intent, Iota, Jaw, Keyless Entry, Keyn Chair Group by Herman Miller, Latitude, Locale, Logic Mini, Logic Power Access Solutions, Live Platform, Loop, Lyris, Lyris 2, Made-to-Measure Storage, Mora, Multiscrim, Nevi, OE1 Workspace Collection, Overlay, Pari, Pixelated Support, Pronta Stacking Chairs by Herman Miller, Prospect, Renew, Sense, Soft Pad, Stackable, Stackable Storage, Striad, Swoop, Thrive, Tone, TriFlex, Twist, Vista, Wireframe, and Zeph are among the trademarks of Herman Miller, Inc., and its owned subsidiaries.

SM Herman Miller Options is among the service marks of Herman Miller, Inc.

AAP™ is a trademark of Extron Electronics.

Alexander Girard® is a registered trademark of The Alexander Girard Estate.

Chemsurf® is a registered trademark of Wilsonart International.

Corian® is a registered trademark of E. I. du Pont de Nemours and Company Corporation.

Crypton® is a registered trademark of Crypton, Inc.

DACRON® is a registered trademark of INVISTA S.a.r.l.

Danzer® is a registered trademark of Danzer Holding AG.

Decora® is a registered trademark of Leviton Manufacturing Co., Inc.

Edelman® Leather is a registered trademark of Edelman Leather, Inc.

Extron® is a registered trademark of RGB Systems, Inc.

FENIX NTM® is a registered trademark of Arpa Industriale S.p.A.

FLEXNET™ is a trademark of Milliken & Company.

Floor Saver Glide® is a registered trademark of Carpin Manufacturing, Inc.

Forest Stewardship Council® is a registered trademark of the Forest Stewardship Council A.C. (FSC). We are FSC® certified (FSC® C102895).

FSC® is a registered trademark of the Forest Stewardship Council A.C. (FSC).

Geiger® is a registered trademark, and Bumper™, Saiba™, and Ward Bennett™ are trademarks, of Geiger International.

Hang-It-All® is a registered trademark of Lucia Eames Demetrios, d.b.a. Eames Office.

Holophane® is a registered trademark of Holophane.

Ingeo™ is a trademark of Cargill Dow LLC.

iPad® and Mac mini® are registered trademarks of Apple Inc.

Leviton® is a registered trademark of Leviton Manufacturing Co., Inc.

LifeSize® is a registered trademark of LifeSize Communications, Inc.

Logitech G® is a registered trademark of Logitech International S.A.

Magis®, Bombo®, and Me Too® are registered trademarks of Magis S.p.A.

MicrobeCare™ is a trademark of Parasol Medical LLC.

Microsoft® and Natural® Keyboard are registered trademarks of Microsoft Corporation.

Noguchi® and the Noguchi table configuration (trade dress) are registered trademarks, and Rudder Table™ is a trademark, of The Isamu Noguchi Foundation and Garden Museum.

Place Textiles® is a registered trademark of Place Textiles.

Sunbrella® is a registered trademark of Glen Raven, Inc.

SuperSeat™ is a trademark of Dahti Seating, a division of ITW.

Valor™ and Whisk™ are among the trademarks owned by Nemschoff, Inc.