

# **ATF 90G-4**

110 TON CAPACITY

# ALL TERRAIN CRANE



Dimensions (ft, mm) / Dimensiones (ft, mm)

445/95 R 25 (16.00 R 25) 525/80 R 25 (20.5 R 25)

SAE

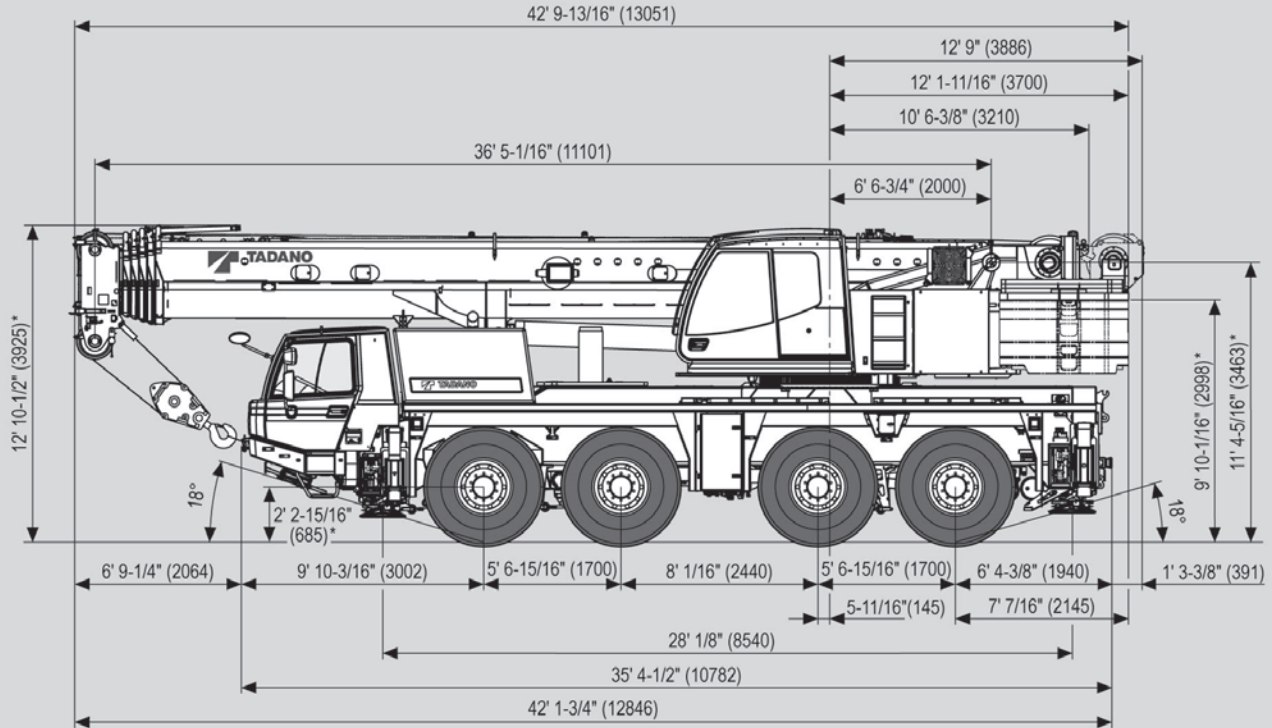

\* ± 3-15/16" (100)

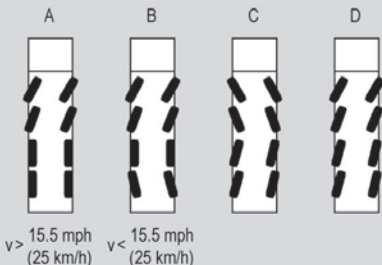
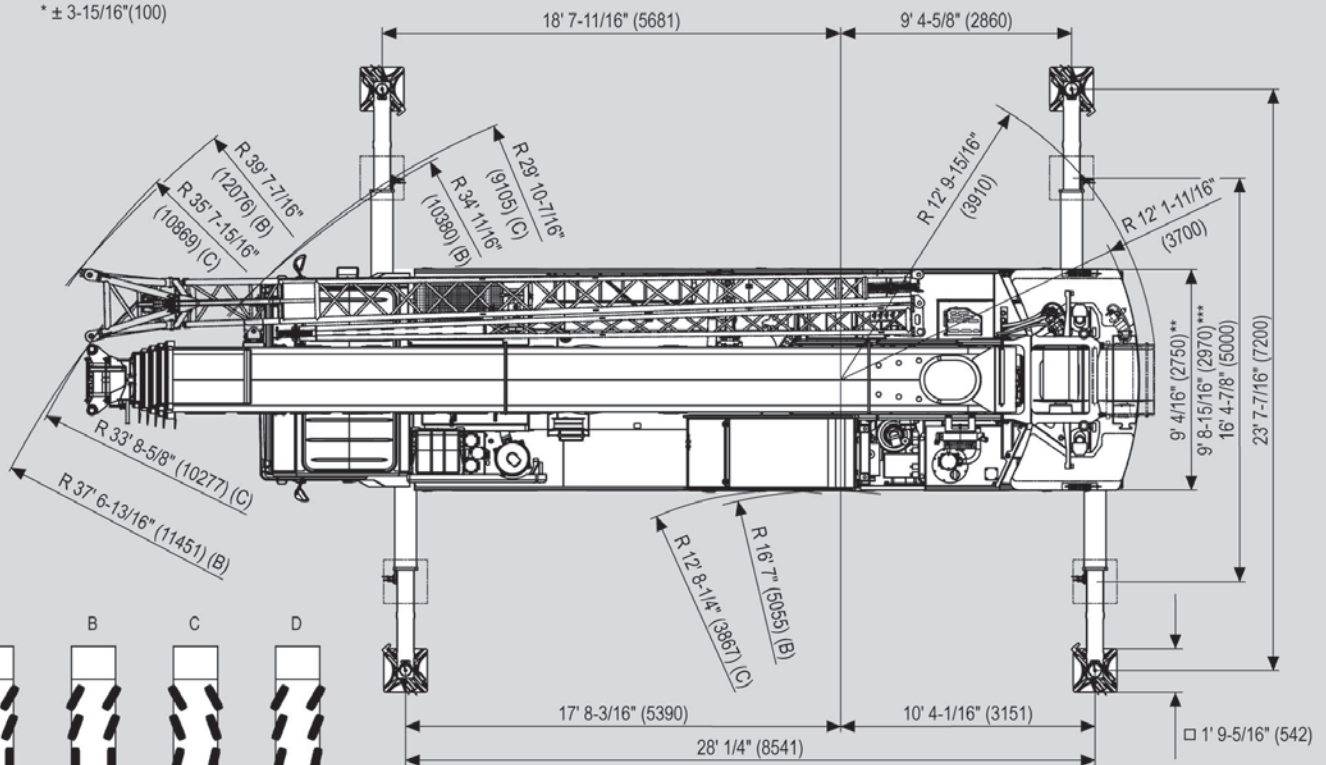







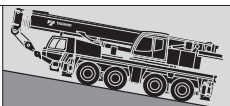

\*\* 445/95 R 25 (16.00 R 25)  
 \*\*\* 525/80 R 25 (20.5 R 25)

## Weights / Working speeds / Pesos / Velocidades de trabajo

 * Rams horn * Gancho doble	Lifting capacity Capacidad de elevación [lbs]	Sheaves Poleas	Parts of line Ramales de cable	Weight Peso [lbs]
	130,293 (Type/ Typo 69.4 ton)*	5	11	1,433
83,996 (Type/ Typo 44.1 ton)*	3	7	1,213	
83,996 (Type/ Typo 44.1 ton)	3	7	1,213	
36,376 (Type/ Typo 22.0 ton)	1	3	661	
12,346 (Type/ Typo 6.6 ton)	–	1	331	

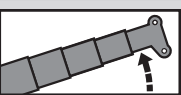
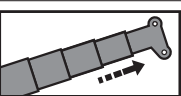

																
		1	2	3	4	5	6	7	8	9	10	11	12	R1	R2	62%
 <b>445/95 R 25</b> (16.00 R 25)	2.5	3.1	3.7	4.9	6.1	7.4	10.0	13.0	16.7	21.1	26.7	34.8	2.4	3.1		
 <b>525/80 R 25</b> (20.5 R 25)	3.7	4.9	6.1	8.0	10.0	13.0	17.4	22.3	28.5	36.6	46.6	52.8	4.3	4.9		

V+ 	Infinitely variable Infinitamente variable	Rope (diameter/length) Cable (diámetro/longitud)	Max. single line pull Trio máximo por ramal
	0 - 377 ft/min 0 - 115 m/min	single line ramal simple	12,364 lbs 55 kN
	0 - 377 ft/min 0 - 115 m/min	single line ramal simple	12,364 lbs 55 kN
	<b>Max. permissible line pull may be affected by wire rope strength, which should not exceed 12,364 lbs (55 kN) for main winch and auxiliary winch.</b> <b>La fuerza max del cabestrante es dependiente de la normativa en vigor, la cual no permite superar los 55 kN de fuerza.</b>		
	0 - 2 rpm		
	-1° - +82.4°	approx. 35 s aproximadamente 35 s	
	36.4 ft - 168.0 ft 11.1 m - 51.2 m	approx. 310 s aproximadamente 310 s	

Lifting heights / Alturas de elevación

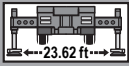
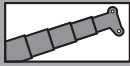



49,163 lbs

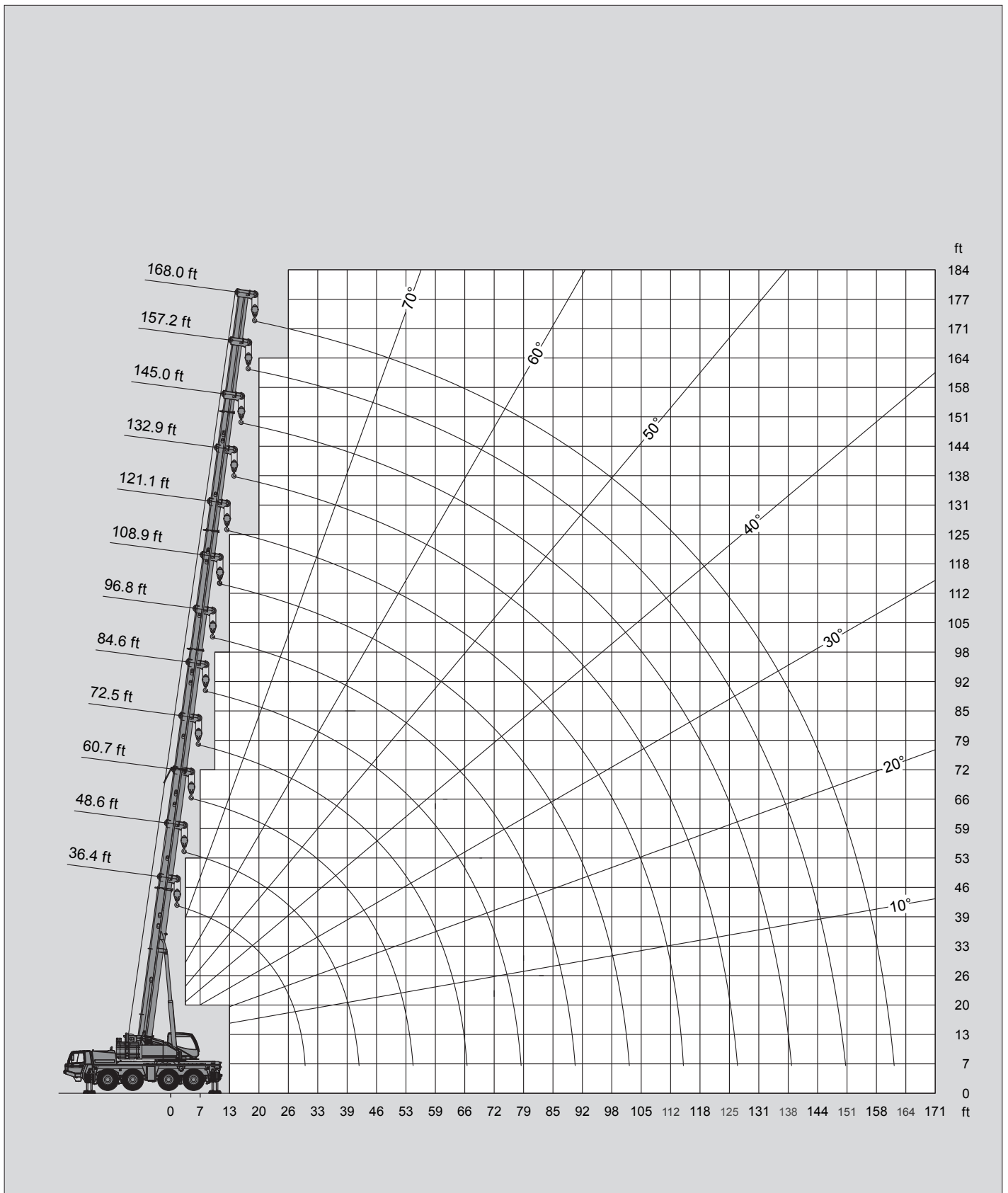

lbs x 1,000

SAE

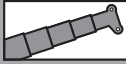
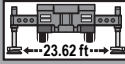

## Lifting capacities / Capacidades de elevación

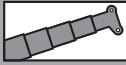
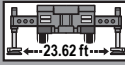

   <b>49,163 lbs</b> <span style="float: right;">lbs x 1,000 <b>SAE</b></span>													
ft	36.4 ft*	36.4 ft	48.6 ft	60.7 ft	72.5 ft	84.6 ft	96.8 ft	108.9 ft	121.1 ft	132.9 ft	145.0 ft	157.2 ft	168.0 ft
8	220.0**												
10	179.9**	167.8**	143.3	143.3									
12	164.5**	154.5	143.3	139.3	110.2								
13	150.6	141.5	140.0	130.5	110.2	91.0							
15	138.0	130.3	129.4	122.6	110.2	90.2							
16	127.4	120.4	119.5	115.3	110.2	86.4	69.7						
20	110.2	104.3	103.2	103.2	101.2	77.2	68.6	52.5					
23	93.7	90.8	89.7	89.9	89.9	73.0	63.5	52.5	43.4	34.8			
26	80.7	78.0	78.0	78.3	78.9	68.8	62.8	52.0	43.4	34.8	28.4		
30	54.9	52.9	70.1	69.2	69.7	65.0	62.8	48.5	43.4	34.8	28.4	22.5	
33			61.7	61.3	61.5	61.7	60.0	45.4	40.8	34.8	28.4	22.5	19.6
36			52.7	52.9	54.5	56.7	53.1	42.5	38.4	34.4	28.4	22.5	19.6
39			45.6	49.4	50.3	50.3	46.7	39.9	36.2	32.6	28.4	22.5	19.6
46				40.1	40.1	39.7	36.6	35.7	32.2	29.3	26.9	22.5	19.6
53				32.8	32.8	32.4	30.4	31.5	28.4	26.5	24.5	22.5	19.6
59					27.6	27.1	26.2	27.1	24.7	24.0	22.3	20.5	19.2
66					21.6	22.9	22.0	22.9	22.5	20.9	20.5	19.0	17.6
72						19.8	19.0	19.8	20.3	18.3	18.5	17.4	16.3
79							17.2	17.0	17.4	17.0	16.8	16.1	15.2
85							16.1	15.0	15.4	15.4	15.2	14.6	13.9
92								13.0	13.9	13.7	13.2	12.6	12.6
98								12.1	12.6	12.1	11.7	11.0	11.0
105									11.5	10.6	10.1	9.5	9.5
112									10.1	9.5	9.0	8.2	8.2
118										8.6	7.9	7.1	7.3
125										7.5	7.1	6.2	6.4
131											6.4	5.3	5.3
138											5.5	4.6	4.6
144												4.2	4.0
151													3.3
158													2.9



   <b>36,376 lbs</b> <span style="float: right;">lbs x 1,000 <b>SAE</b></span>													
ft	36.4 ft*	36.4 ft	48.6 ft	60.7 ft	72.5 ft	84.6 ft	96.8 ft	108.9 ft	121.1 ft	132.9 ft	145.0 ft	157.2 ft	168.0 ft
8	220.0**												
10	179.9**	168.7**	143.3	143.3									
12	163.4**	153.4	143.3	139.3	110.2								
13	148.8	140.4	139.3	130.5	110.2	91.0							
15	136.5	129.0	127.9	122.6	110.2	90.2							
16	126.1	119.0	117.9	115.3	110.2	86.4	69.7						
20	105.8	102.5	101.2	101.6	101.2	77.2	68.6	52.5					
23	89.3	87.7	86.6	86.9	86.0	73.0	63.5	52.5	43.4	34.8			
26	76.9	76.5	75.6	75.0	71.6	68.8	62.8	52.0	43.4	34.8	28.4		
30	54.9	52.9	62.8	62.6	62.6	62.6	59.1	48.5	43.4	34.8	28.4	22.5	
33			52.5	54.7	57.1	54.7	51.6	45.4	40.8	34.8	28.4	22.5	19.6
36			46.1	49.2	50.0	47.0	45.6	42.5	38.4	34.4	28.4	22.5	19.6
39			42.5	43.4	43.7	40.8	39.9	39.2	36.2	32.6	28.4	22.5	19.6
46				34.2	34.4	31.7	31.1	32.0	30.0	29.3	26.9	22.5	19.6
53				27.8	28.0	25.6	26.0	26.9	26.2	24.3	24.5	22.5	19.6
59					23.4	21.8	22.3	22.5	21.6	21.4	21.4	20.5	19.2
66					20.5	19.6	20.1	19.0	19.2	18.3	19.0	18.3	17.6
72						17.9	17.9	16.5	17.2	16.3	16.5	15.7	15.7
79							15.4	14.8	15.0	14.3	14.3	13.4	13.4
85							13.7	13.2	13.0	12.3	12.1	11.5	11.5
92								11.7	11.5	10.8	10.4	9.7	9.7
98								10.1	9.9	9.5	9.0	8.2	8.2
105									8.8	7.9	7.7	7.1	7.1
112									7.7	7.1	6.6	5.7	5.7
118										6.2	5.7	4.9	4.9
125										5.3	4.9	4.2	4.2
131											4.2	3.3	3.3
138											3.3	2.6	2.6
144												2.2	2.2
151													1.8
158													1.3

\* Over rear / \* Sobre la parte trasera

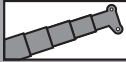
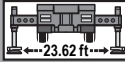
\*\* With additional lifting equipment / \*\* Con equipo adicional

## Lifting capacities / Capacidades de elevación

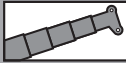
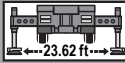

   <b>23,369 lbs</b> <span style="float: right;">lbs x 1,000 <b>SAE</b></span>													
ft	36.4 ft*	36.4 ft	48.6 ft	60.7 ft	72.5 ft	84.6 ft	96.8 ft	108.9 ft	121.1 ft	132.9 ft	145.0 ft	157.2 ft	168.0 ft
8	220.0**												
10	178.8**	167.5**	143.3	143.3									
12	161.6**	152.1	143.3	139.3	110.2								
13	147.3	138.9	137.8	130.5	110.2	91.0							
15	135.1	127.4	126.3	122.6	110.2	90.2							
16	122.8	117.5	116.4	115.3	110.2	86.4	69.7						
20	100.8	98.8	97.4	95.2	89.9	77.2	68.6	52.5					
23	86.6	84.2	82.0	75.8	72.5	73.0	63.5	52.5	43.4	34.8			
26	67.7	67.2	65.0	63.9	65.3	61.5	57.8	52.0	43.4	34.8	28.4		
30	53.8	53.8	52.5	57.3	58.6	53.8	49.6	46.5	43.4	34.8	28.4	22.5	
33			47.6	48.9	48.9	47.6	43.2	42.8	39.0	34.8	28.4	22.5	19.6
36			40.6	41.9	41.9	41.4	38.8	37.9	34.4	33.7	28.4	22.5	19.6
39			35.1	36.4	36.4	35.9	35.1	34.0	32.2	30.0	28.4	22.5	19.6
46				28.2	28.9	28.0	27.3	26.2	26.9	25.4	24.3	22.5	19.6
53				22.7	23.6	23.4	23.6	21.8	22.0	21.4	21.2	19.8	19.4
59					19.4	19.4	19.8	19.4	18.7	18.3	17.6	17.0	16.3
66					16.5	16.3	16.8	16.3	15.9	15.4	14.8	14.3	13.9
72						13.9	14.1	13.7	13.4	13.0	12.6	11.9	11.7
79							12.1	11.7	11.7	11.0	10.6	9.7	9.7
85							10.4	9.9	9.7	9.3	8.8	7.9	7.9
92								8.6	8.2	7.7	7.3	6.6	6.6
98								7.3	7.1	6.6	6.2	5.3	5.3
105									6.2	5.5	5.1	4.4	4.4
112									5.1	4.6	4.2	3.3	3.3
118										4.0	3.3	2.6	2.6
125										3.1	2.6	2.0	2.0
131											2.2	1.3	1.3
138											1.5		
144													
151													
158													



   <b>14,330 lbs</b> <span style="float: right;">lbs x 1,000 <b>SAE</b></span>													
ft	36.4 ft*	36.4 ft	48.6 ft	60.7 ft	72.5 ft	84.6 ft	96.8 ft	108.9 ft	121.1 ft	132.9 ft	145.0 ft	157.2 ft	168.0 ft
8	220.0**												
10	177.2**	166.7**	143.3	143.3									
12	160.3**	151.0	143.3	139.3	110.2								
13	145.9	137.6	136.7	130.5	110.2	91.0							
15	132.9	126.1	125.0	122.6	110.2	90.2							
16	118.6	114.6	113.3	110.2	102.7	86.4	69.7						
20	101.9	95.9	89.3	84.0	78.7	75.4	68.6	52.5					
23	75.8	75.6	73.2	67.2	68.6	64.4	60.0	52.5	43.4	34.8			
26	59.1	58.4	56.2	61.7	58.6	54.9	50.5	47.0	43.4	34.8	28.4		
30	47.8	47.0	49.6	50.9	51.1	47.4	43.9	42.5	38.4	34.8	28.4	22.5	
33			41.2	42.5	42.5	42.1	38.6	37.0	35.5	32.2	28.4	22.5	19.6
36			34.8	36.2	36.4	35.7	34.4	32.4	32.0	28.4	27.8	22.5	19.6
39			30.0	30.9	32.2	30.4	30.6	28.7	28.2	27.6	24.7	22.5	19.6
46				23.6	24.7	24.9	25.1	24.3	24.7	22.9	21.2	19.8	19.2
53				18.5	19.6	19.6	20.1	19.6	19.6	19.0	18.5	17.2	16.8
59					16.1	16.1	16.3	16.1	15.9	15.4	15.0	14.3	14.1
66					13.2	13.2	13.4	13.2	13.0	12.6	12.1	11.5	11.5
72						11.2	11.5	11.2	11.0	10.1	9.9	9.0	9.0
79							9.5	9.3	9.0	8.2	7.9	7.3	7.3
85							7.9	7.7	7.5	6.8	6.6	5.7	5.5
92								6.6	6.4	5.5	5.3	4.4	4.4
98								5.3	5.1	4.6	4.2	3.3	3.3
105									4.4	3.7	3.1	2.4	2.4
112									3.3	2.9	2.4	1.8	1.8
118										2.2	1.8		
125										1.8	1.3		
131													
138													
144													
151													
158													

\* Over rear / \* Sobre la parte trasera

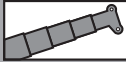
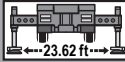
\*\* With additional lifting equipment / \*\* Con equipo adicional

## Lifting capacities / Capacidades de elevación

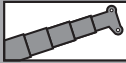
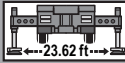
   <b>12,125 lbs</b> <span style="float: right;">lbs x 1,000 <b>SAE</b></span>													
ft	36.4 ft*	36.4 ft	48.6 ft	60.7 ft	72.5 ft	84.6 ft	96.8 ft	108.9 ft	121.1 ft	132.9 ft	145.0 ft	157.2 ft	168.0 ft
8	220.0**												
10	177.0**	166.2**	143.3	143.3									
12	159.8**	150.6	143.3	139.3	110.2								
13	145.7	137.3	136.2	130.5	110.2	91.0							
15	131.2	125.2	124.1	121.5	110.2	90.2							
16	117.1	113.5	112.2	105.2	97.9	86.4	69.7						
20	99.0	95.2	86.2	79.1	76.1	75.2	66.4	52.5					
23	72.5	71.6	69.4	66.1	66.4	61.3	57.5	52.5	43.4	34.8			
26	56.0	55.3	55.3	59.5	56.2	52.7	48.5	46.1	42.5	34.8	28.4		
30	45.2	44.5	47.0	48.3	48.5	45.4	41.9	40.3	35.9	34.8	28.4	22.5	
33			39.0	40.3	40.6	39.9	36.6	34.8	34.2	30.2	28.4	22.5	19.6
36			32.6	34.0	34.2	33.5	32.6	30.4	30.0	28.4	26.0	22.5	19.6
39			27.8	28.9	30.2	30.0	30.6	27.1	27.6	25.8	24.3	22.5	19.6
46				22.0	23.1	23.4	23.6	22.9	22.5	21.6	20.7	19.2	17.9
53				17.2	18.3	18.3	18.7	18.3	18.3	17.4	17.2	15.9	15.7
59					14.8	14.8	15.0	14.8	14.6	13.9	13.9	13.0	13.0
66					12.3	12.3	12.6	12.3	12.1	11.5	11.2	10.1	10.1
72						10.1	10.4	10.1	9.9	9.3	9.0	7.9	7.9
79							8.8	8.2	7.9	7.5	7.1	6.4	6.4
85							7.3	6.8	6.6	6.2	5.5	4.9	4.9
92								5.5	5.5	4.9	4.6	3.7	3.7
98								4.6	4.4	4.0	3.3	2.6	2.6
105									3.7	2.9	2.6	2.0	2.0
112									2.9	2.2	2.0	1.3	
118										1.8	1.3		
125													
131													
138													
144													
151													
158													

   <b>0 lbs</b> <span style="float: right;">lbs x 1,000 <b>SAE</b></span>													
ft	36.4 ft*	36.4 ft	48.6 ft	60.7 ft	72.5 ft	84.6 ft	96.8 ft	108.9 ft	121.1 ft	132.9 ft	145.0 ft	157.2 ft	168.0 ft
8	220.0**												
10	175.0**	164.7**	143.3	143.3									
12	158.3**	148.8	143.3	139.3	110.2								
13	142.2	134.9	133.6	122.4	110.2	91.0							
15	125.4	121.0	113.8	102.7	94.6	84.9							
16	108.9	108.9	94.8	86.2	80.5	75.4	69.2						
20	81.3	81.3	70.3	71.4	67.0	62.2	57.3	52.5					
23	61.5	59.1	59.7	58.9	55.3	50.7	46.3	44.5	40.3	34.8			
26	46.5	45.4	48.3	48.7	45.6	42.1	40.3	37.5	35.5	31.3	28.4		
30	37.5	35.5	38.4	40.1	39.0	36.4	35.9	33.1	31.7	28.4	26.0	22.5	
33			31.1	32.6	34.4	32.8	31.7	30.0	28.2	26.2	24.0	22.5	19.6
36			26.0	27.6	28.9	28.9	27.8	26.2	25.1	23.4	21.8	20.5	19.0
39			22.0	23.6	24.9	25.1	24.7	23.6	22.0	20.7	19.4	17.9	17.2
46				17.6	18.7	19.0	19.4	18.7	17.9	16.8	15.9	14.3	13.7
53				13.7	14.8	14.8	15.2	14.8	14.6	13.4	12.6	11.5	11.0
59					11.7	11.9	12.1	11.9	11.7	11.0	10.1	9.0	8.8
66					9.5	9.5	9.7	9.5	9.3	8.8	8.2	7.1	6.8
72						7.7	7.9	7.7	7.5	6.8	6.6	5.3	5.3
79							6.6	6.2	6.2	5.3	4.9	4.2	4.0
85							5.3	4.9	4.6	4.2	3.7	2.9	2.9
92								4.0	3.7	3.1	2.6		
98								3.1	2.9	2.2	1.8		
105									2.2	1.5			
112									1.5				
118													
125													
131													
138													
144													
151													
158													

\* Over rear / \* Sobre la parte trasera

\*\* With additional lifting equipment / \*\* Con equipo adicional

## Lifting heights / Alturas de elevación

**49,163 lbs** lbs x 1,000 **SAE**

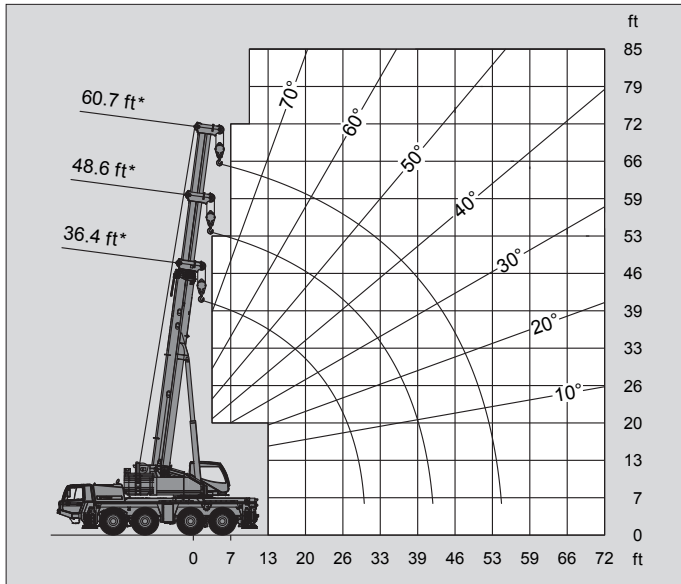

\* Superstructure locked / \* Bloqueo de superestructura

**49,163 lbs** lbs x 1,000 **SAE**

ft	36.4 ft*	48.6 ft*	60.7 ft*
10	37.7	38.4	39.0
12	34.4	35.3	35.7
13	31.5	32.4	32.8
15	29.1	30.0	30.4
16	26.9	27.8	28.2
20	23.1	24.0	24.7
23	20.1	21.2	21.6
26	17.6	18.7	19.2
30	15.7	16.5	17.2
33		14.8	15.4
36		13.4	13.9
39		12.1	12.8
46			10.6
53			8.6

**36,376 lbs** lbs x 1,000 **SAE**

ft	36.4 ft*	48.6 ft*	60.7 ft*
10	38.1	39.0	39.7
12	34.8	35.7	36.4
13	32.0	32.8	33.5
15	29.5	30.4	31.1
16	27.3	28.2	28.9
20	23.6	24.5	25.1
23	20.5	21.6	22.0
26	18.1	19.0	19.6
30	15.0	16.8	17.6
33		14.1	15.2
36		12.1	13.0
39		10.4	11.2
46			8.6
53			6.6

## Lifting capacities / Capacidades de elevación

**23,369 lbs** lbs x 1,000 **SAE**

ft	36.4 ft*	48.6 ft*	60.7 ft*
10	38.8	39.7	40.3
12	35.5	36.4	36.8
13	32.6	33.5	34.0
15	30.0	30.9	31.5
16	27.8	28.7	29.3
20	22.7	24.5	25.6
23	17.6	19.4	20.5
26	14.1	15.9	16.8
30	11.2	13.0	14.1
33		10.8	11.9
36		9.0	9.9
39		7.7	8.6
46			6.4
53			4.4

**14,330 lbs** lbs x 1,000 **SAE**

ft	36.4 ft*	48.6 ft*	60.7 ft*
10	39.2	40.1	40.8
12	35.9	36.8	37.3
13	33.1	34.0	34.4
15	29.1	31.1	32.0
16	24.9	26.9	28.0
20	18.5	20.5	21.6
23	14.3	16.1	17.2
26	11.2	12.8	13.9
30	8.8	10.4	11.5
33		8.6	9.5
36		7.1	7.9
39		5.7	6.6
46			4.6
53			3.1

**12,125 lbs** lbs x 1,000 **SAE**



ft	36.4 ft*	48.6 ft*	60.7 ft*
10	39.5	40.3	40.8
12	36.2	36.8	37.5
13	32.8	34.0	34.6
15	27.3	29.3	30.6
16	23.4	25.4	26.5
20	17.4	19.2	20.3
23	13.2	15.0	16.1
26	10.4	11.9	13.0
30	7.9	9.7	10.6
33		7.7	8.8
36		6.4	7.3
39		5.1	6.2
46			4.2
53			2.6



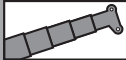

A large grid area for taking notes, consisting of a grey background with a white grid pattern.

## Lifting heights / Alturas de elevación

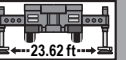





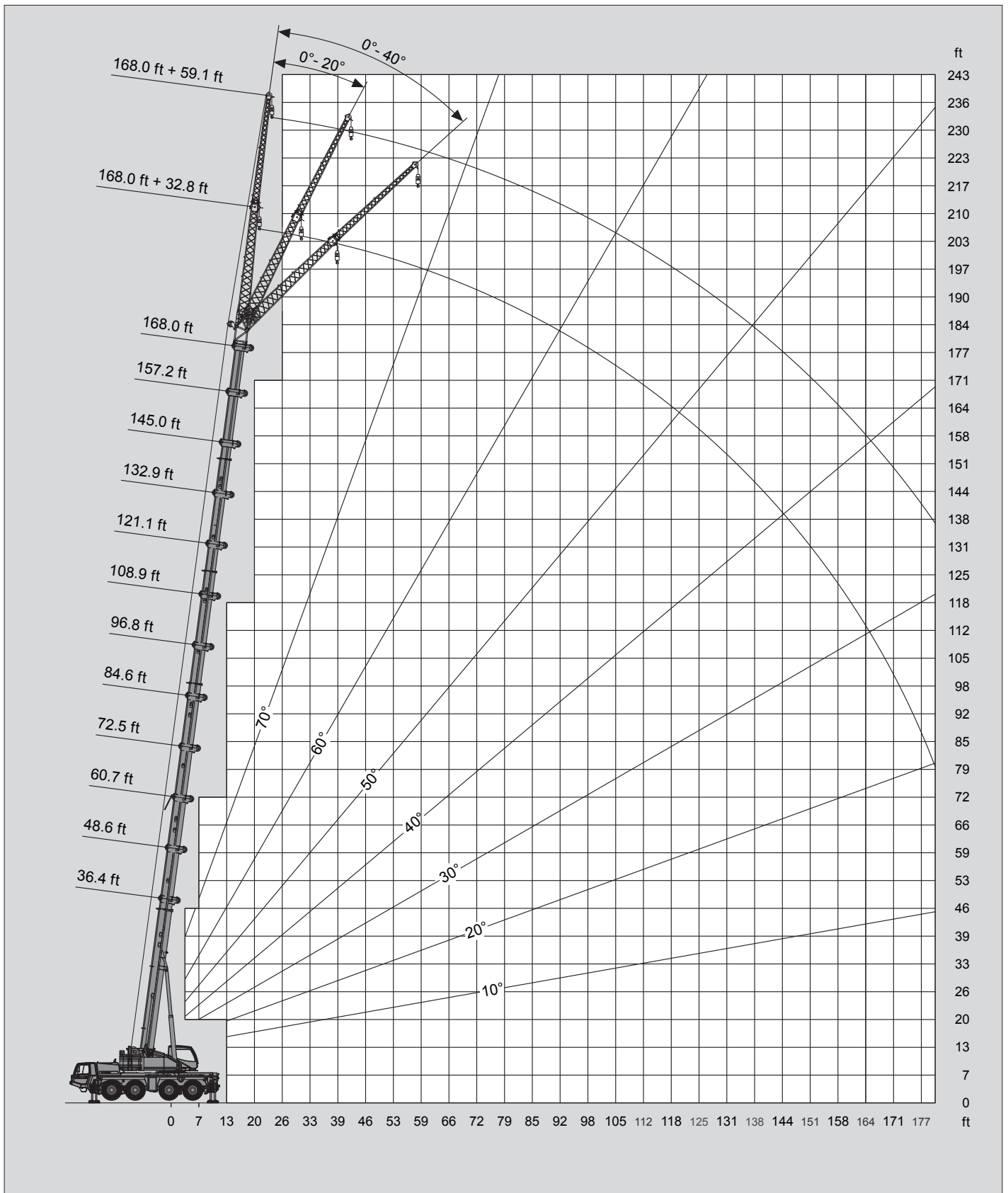

49,163 lbs

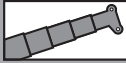
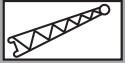
lbs x 1,000

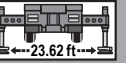
SAE



49,163 lbs

lbs x 1,000





SAE

ft	36.4 ft + 32.8 ft			108.9 ft + 32.8 ft			157.2 ft + 32.8 ft			168.0 ft + 32.8 ft		
	0°	20°	40°	0°	20°	40°	0°	20°	40°	0°	20°	40°
10	26.9*											
12	26.9*											
13	26.9*											
15	26.9*											
16	26.9*	26.9*										
20	26.9*	25.4*										
23	26.9*	23.8		22.3								
26	26.9*	22.5	16.3	22.3								
30	26.7*	21.2	15.7	22.3								
33	24.9*	19.8	14.8	22.3	19.6							
36	22.9	18.7	14.1	22.3	19.0		10.8					
39	21.2	17.6	13.7	21.8	18.3		10.8			9.7		
46	17.9	15.7	12.8	20.1	17.0	14.8	10.8			9.7		
53	15.4	14.3		18.7	15.7	13.9	10.8	10.8		9.7	9.7	
59				17.4	14.8	13.2	10.8	10.6	9.9	9.7	9.7	
66				16.3	13.9	12.6	10.8	9.9	9.5	9.7	9.3	8.8
72				15.2	13.2	12.1	10.6	9.5	9.0	9.7	8.8	8.4
79				14.3	12.6	11.5	9.9	9.0	8.6	9.3	8.6	8.2
85				13.4	12.1	11.2	9.5	8.8	8.4	8.6	8.2	7.7
92				11.9	11.5	10.8	8.8	8.4	7.9	8.2	7.9	7.5
98				10.1	11.0	10.4	8.4	8.2	7.7	7.7	7.5	7.3
105				8.8	9.5	9.7	7.9	7.7	7.5	7.5	7.3	7.1
112				7.5	7.9		7.5	7.5	7.3	7.1	6.8	6.8
118				6.6	7.1		6.6	7.1	7.1	6.6	6.6	6.6
125				5.5	5.7		5.7	6.4	6.8	5.7	6.4	6.2
131				4.9			5.1	5.5	5.7	4.9	5.3	5.7
138							4.4	4.6	4.9	4.2	4.6	4.9
144							3.7	4.0	4.2	3.3	4.0	4.2
151							2.9	3.1		2.6	3.1	3.3
158							2.4	2.6		2.2	2.6	
164							2.0	2.2		1.8	2.0	
171							1.5	1.5		1.3	1.5	

\* With additional lifting equipment / \* Con equipo adicional

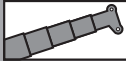
ft	36.4 ft + 59.1 ft			108.9 ft + 59.1 ft			157.2 ft + 59.1 ft			168.0 ft + 59.1 ft		
	0°	20°	40°	0°	20°	40°	0°	20°	40°	0°	20°	40°
10												
12	12.8											
13	12.8											
15	12.8											
16	12.8											
20	12.8											
23	12.8											
26	12.8			9.3								
30	12.8			9.3								
33	12.8	11.7		9.3								
36	12.8	11.0		9.3								
39	12.6	10.6		9.3			6.4					
46	11.5	9.7		9.3			6.4			6.0		
53	10.4	9.0	7.1	9.3	9.3		6.4			6.0		
59	9.3	8.2	6.6	9.3	9.0		6.4			6.0		
66	8.2	7.5	6.2	9.3	8.6	7.1	6.4	6.4		6.0		
72	7.3	6.8	5.7	9.3	8.4	6.8	6.4	6.4		6.0	6.0	
79	6.6	6.4	5.5	9.3	7.9	6.6	6.4	6.4		6.0	6.0	
85	6.0	6.2		9.3	7.7	6.4	6.4	6.4	6.2	6.0	6.0	5.7
92				9.0	7.5	6.2	6.4	6.2	5.7	6.0	6.0	5.5
98				8.6	7.3	6.0	6.4	6.0	5.7	6.0	5.7	5.3
105				8.4	7.1	5.7	6.4	5.7	5.5	6.0	5.5	5.1
112				7.9	6.8	5.7	6.2	5.5	5.3	5.7	5.3	5.1
118				7.5	6.6	5.5	6.0	5.3	5.1	5.5	5.1	4.9
125				6.8	6.4	5.5	5.7	5.3	4.9	5.3	4.9	4.6
131				5.7	6.2	5.5	5.5	5.1	4.9	5.1	4.9	4.6
138				5.1	5.7		4.9	4.9	4.6	4.6	4.6	4.4
144				4.4	4.9		4.2	4.6	4.6	4.0	4.4	4.2
151				4.0	4.2		3.3	4.4	4.4	3.3	4.0	4.2
158				3.3			2.9	3.7	4.2	2.6	3.3	3.7
164							2.4	2.9	3.3	2.2	2.9	3.3
171							2.0	2.4	2.6	1.8	2.4	2.6
177							1.5	2.0		1.3	1.8	2.2
184								1.5			1.5	

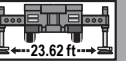
## Lifting capacities / Capacidades de elevación









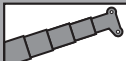
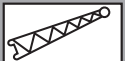

36,376 lbs

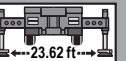
lbs x 1,000 **SAE**

ft	36.4 ft + 32.8 ft			108.9 ft + 32.8 ft			157.2 ft + 32.8 ft			168.0 ft + 32.8 ft		
	0°	20°	40°	0°	20°	40°	0°	20°	40°	0°	20°	40°
10	26.9*											
12	26.9*											
13	26.9*											
15	26.9*											
16	26.9*	26.9*										
20	26.9*	25.4*										
23	26.9*	23.8		22.3								
26	26.9*	22.5	16.3	22.3								
30	26.7*	21.2	15.7	22.3								
33	24.9*	19.8	14.8	22.3	19.6							
36	22.9	18.7	14.1	22.3	19.0		10.8					
39	21.2	17.6	13.7	21.8	18.3		10.8			9.7		
46	17.9	15.7	12.8	20.1	17.0	14.8	10.8			9.7		
53	15.4	14.3		18.7	15.7	13.9	10.8	10.8		9.7	9.7	
59				17.4	14.8	13.2	10.8	10.6	9.9	9.7	9.7	
66				16.3	13.9	12.6	10.8	9.9	9.5	9.7	9.3	8.8
72				13.9	13.2	12.1	10.6	9.5	9.0	9.7	8.8	8.4
79				11.5	12.6	11.5	9.9	9.0	8.6	9.3	8.6	8.2
85				9.9	11.2	11.2	9.5	8.8	8.4	8.6	8.2	7.7
92				8.6	9.5	10.1	8.6	8.4	7.9	8.2	7.9	7.5
98				7.5	8.2	8.8	7.5	7.9	7.7	7.3	7.5	7.3
105				6.4	6.8	7.3	6.4	7.1	7.3	6.4	7.1	7.1
112				5.1	5.5		5.5	6.2	6.6	5.3	6.2	6.6
118				4.4	4.6		4.6	5.1	5.5	4.4	5.1	6.5
125				3.3	3.7		3.7	4.4	4.6	3.7	4.2	4.6
131				2.6			2.9	3.5	4.0	3.1	3.3	3.7
138							2.2	2.6	3.1	2.2	2.6	2.9
144							1.8	2.2	2.2	1.5	2.0	2.2
151							1.3	1.5			1.5	1.8

\* With additional lifting equipment / \* Con equipo adicional

36,376 lbs

lbs x 1,000 **SAE**

ft	36.4 ft + 59.1 ft			108.9 ft + 59.1 ft			157.2 ft + 59.1 ft			168.0 ft + 59.1 ft		
	0°	20°	40°	0°	20°	40°	0°	20°	40°	0°	20°	40°
10												
12	12.8											
13	12.8											
15	12.8											
16	12.8											
20	12.8											
23	12.8											
26	12.8			9.3								
30	12.8			9.3								
33	12.8	11.7		9.3								
36	12.8	11.0		9.3								
39	12.6	10.6		9.3			6.4					
46	11.5	9.7		9.3			6.4			6.0		
53	10.4	9.0	7.1	9.3	9.3		6.4			6.0		
59	9.3	8.2	6.6	9.3	9.0		6.4			6.0		
66	8.2	7.5	6.2	9.3	8.6	7.1	6.4	6.4		6.0		
72	7.3	6.8	5.7	9.3	8.4	6.8	6.4	6.4		6.0	6.0	
79	6.6	6.4	5.5	9.3	7.9	6.6	6.4	6.4		6.0	6.0	
85	6.0	6.2		9.3	7.7	6.4	6.4	6.4	6.2	6.0	6.0	5.7
92				9.0	7.5	6.2	6.4	6.2	5.7	6.0	6.0	5.5
98				8.2	7.3	6.0	6.4	6.0	5.7	6.0	5.7	5.3
105				7.3	7.1	5.7	6.4	5.7	5.5	6.0	5.5	5.1
112				6.4	6.8	5.7	5.5	5.5	5.3	5.5	5.3	5.1
118				5.5	6.4	5.5	4.9	5.3	5.1	5.1	5.1	4.9
125				4.6	5.5	5.5	4.2	5.1	4.9	4.2	4.9	4.6
131				4.0	4.6	5.1	3.5	4.4	4.9	3.3	4.4	4.6
138				3.1	4.0		2.9	3.7	4.4	2.6	3.7	4.2
144				2.6	3.1		2.2	3.1	3.7	2.2	2.9	3.7
151				2.0	2.4		1.8	2.4	2.9	1.5	2.4	2.9
158				1.8			1.3	2.0	2.4		1.8	2.2
164								1.5	1.8		1.3	1.8
171									1.3			1.3





ft	36.4 ft + 32.8 ft			108.9 ft + 32.8 ft			157.2 ft + 32.8 ft			168.0 ft + 32.8 ft		
	0°	20°	40°	0°	20°	40°	0°	20°	40°	0°	20°	40°
10	26.9*											
12	26.9*											
13	26.9*											
15	26.9*											
16	26.9*	26.9*										
20	26.9*	25.4*										
23	26.9*	23.8		22.3								
26	26.9*	22.5	16.3	22.3								
30	26.7*	21.2	15.7	22.3								
33	24.9*	19.8	14.8	22.3	19.6							
36	22.9	18.7	14.1	22.3	19.0		10.8					
39	21.2	17.6	13.7	21.8	18.3		10.8			9.7		
46	17.9	15.7	12.8	20.1	17.0	14.8	10.8			9.7		
53	15.4	14.3		18.7	15.7	13.9	10.8	10.8		9.7	9.7	
59				15.7	14.8	13.2	10.8	10.6	9.9	9.7	9.7	
66				12.8	13.9	12.6	10.8	9.9	9.5	9.7	9.3	8.8
72				10.8	12.3	12.1	10.6	9.5	9.0	9.7	8.8	8.4
79				9.0	10.1	11.0	9.5	9.0	8.6	9.3	8.6	8.2
85				7.3	8.2	9.0	7.7	8.6	8.4	7.5	8.2	7.7
92				5.7	6.6	7.3	6.4	7.3	7.9	6.2	7.1	7.3
98				4.6	5.3	5.7	5.1	5.7	6.6	4.9	5.7	6.6
105				3.7	4.2	4.6	4.0	4.9	5.3	4.0	4.6	5.3
112				2.6	3.1		3.1	3.7	4.2	2.9	3.7	4.2
118				2.0	2.4		2.2	2.9	3.3	2.2	2.6	3.1
125				1.3	1.5		1.5	2.2	2.4	1.5	2.0	2.4
131								1.5	1.8		1.3	1.8

\* With additional lifting equipment / \* Con equipo adicional



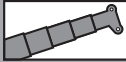
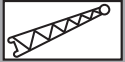

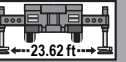
ft	36.4 ft + 59.1 ft			108.9 ft + 59.1 ft			157.2 ft + 59.1 ft			168.0 ft + 59.1 ft		
	0°	20°	40°	0°	20°	40°	0°	20°	40°	0°	20°	40°
10												
12	12.8											
13	12.8											
15	12.8											
16	12.8											
20	12.8											
23	12.8											
26	12.8			9.3								
30	12.8			9.3								
33	12.8	11.7		9.3								
36	12.8	11.0		9.3								
39	12.6	10.6		9.3								
46	11.5	9.7		9.3			6.4					
53	10.4	9.0	7.1	9.3	9.3		6.4			6.0		
59	9.3	8.2	6.6	9.3	9.0		6.4			6.0		
66	8.2	7.5	6.2	9.3	8.6	7.1	6.4	6.4		6.0		
72	7.3	6.8	5.7	9.3	8.4	6.8	6.4	6.4		6.0	6.0	
79	6.6	6.4	5.5	9.3	7.9	6.6	6.4	6.4		6.0	6.0	
85	6.0	6.2		8.4	7.7	6.4	6.4	6.4	6.2	6.0	6.0	5.7
92				7.3	7.5	6.2	6.4	6.2	5.7	6.0	6.0	5.5
98				6.2	7.3	6.0	5.5	6.0	5.7	5.5	5.7	5.3
105				4.9	6.2	5.7	4.6	5.7	5.5	4.4	5.5	5.1
112				4.0	5.1	5.5	3.7	5.1	5.3	3.3	4.9	5.1
118				3.1	4.2	4.9	2.9	4.2	5.1	2.6	4.0	4.9
125				2.4	3.3	4.0	2.2	3.1	4.2	2.0	3.1	4.0
131				1.8	2.4	2.9	1.5	2.4	3.1	1.3	2.4	3.1
138				1.3	2.0			2.0	2.4		1.8	2.4
144					1.3			1.3	2.0			1.8
151									1.3			



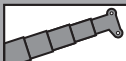
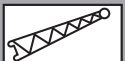

Subject to change without prior notice / Sujeto a cambios sin previo aviso

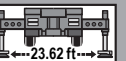
## Lifting capacities / Capacidades de elevación



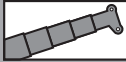
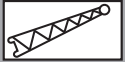

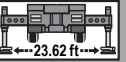
     <b>14,330 lbs</b> <span style="float: right;">lbs x 1,000 <b>SAE</b></span>												
ft	36.4 ft + 32.8 ft			108.9 ft + 32.8 ft			157.2 ft + 32.8 ft			168.0 ft + 32.8 ft		
	0°	20°	40°	0°	20°	40°	0°	20°	40°	0°	20°	40°
10	26.9*											
12	26.9*											
13	26.9*											
15	26.9*											
16	26.9*	26.9*										
20	26.9*	25.4*										
23	26.9*	23.8		22.3								
26	26.9*	22.5	16.3	22.3								
30	26.7*	21.2	15.7	22.3								
33	24.9*	19.8	14.8	22.3	19.6							
36	22.9	18.7	14.1	22.3	19.0		10.8					
39	21.2	17.6	13.7	21.8	18.3		10.8			9.7		
46	17.9	15.7	12.8	19.8	17.0	14.8	10.8			9.7		
53	15.4	14.3		16.1	15.7	13.9	10.8	10.8		9.7	9.7	
59				13.0	13.7	13.2	10.8	10.6	9.9	9.7	9.7	
66				10.4	11.5	11.9	10.1	9.9	9.5	9.7	9.3	8.8
72				8.2	9.5	9.9	8.2	9.3	9.0	8.8	8.8	8.4
79				6.6	7.5	8.2	6.6	7.9	8.6	6.8	7.9	8.2
85				4.9	5.7	6.6	5.3	6.6	7.3	5.3	6.4	7.3
92				3.7	4.6	5.1	4.2	5.1	5.7	4.0	4.9	5.7
98				2.6	3.3	4.0	3.1	4.0	4.6	2.9	4.0	4.4
105				1.8	2.4	2.6	2.2	2.9	3.3	2.0	2.6	3.3
112					1.5		1.3	2.0	2.4	2.0	2.0	2.4
118								1.3	1.8			1.8

\* With additional lifting equipment / \* Con equipo adicional

     <b>14,330 lbs</b> <span style="float: right;">lbs x 1,000 <b>SAE</b></span>												
ft	36.4 ft + 59.1 ft			108.9 ft + 59.1 ft			157.2 ft + 59.1 ft			168.0 ft + 59.1 ft		
	0°	20°	40°	0°	20°	40°	0°	20°	40°	0°	20°	40°
10												
12	12.8											
13	12.8											
15	12.8											
16	12.8											
20	12.8											
23	12.8											
26	12.8			9.3								
30	12.8			9.3								
33	12.8	11.7		9.3								
36	12.8	11.0		9.3								
39	12.6	10.6		9.3			6.4					
46	11.5	9.7		9.3			6.4			6.0		
53	10.4	9.0	7.1	9.3	9.3		6.4			6.0		
59	9.3	8.2	6.6	9.3	9.0		6.4			6.0		
66	8.2	7.5	6.2	9.3	8.6	7.1	6.4	6.4		6.0		
72	7.3	6.8	5.7	8.8	8.4	6.8	6.4	6.4		6.0	6.0	
79	6.6	6.4	5.5	7.9	7.9	6.6	6.4	6.4		6.0	6.0	
85	6.0	6.2		6.4	7.7	6.4	6.0	6.4	6.2	5.3	6.0	5.7
92				5.1	6.6	6.2	4.9	6.0	5.7	4.4	5.7	5.5
98				4.0	5.3	6.0	3.7	5.3	5.7	3.5	5.1	5.3
105				3.1	4.4	5.3	2.6	4.2	5.3	2.6	4.2	5.1
112				2.2	3.3	4.2	2.0	3.1	4.4		3.1	4.2
118				1.5	2.4	3.1		2.4	3.3		2.4	3.3
125					1.8	2.4		1.8	2.6			2.4
131						1.5			2.0			

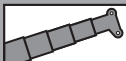
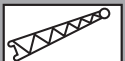
     <b>12,125 lbs</b> <span style="float: right;">lbs x 1,000 <b>SAE</b></span>												
 ft	36.4 ft + 32.8 ft			108.9 ft + 32.8 ft			157.2 ft + 32.8 ft			168.0 ft + 32.8 ft		
	0°	20°	40°	0°	20°	40°	0°	20°	40°	0°	20°	40°
10	26.9*											
12	26.9*											
13	26.9*											
15	26.9*											
16	26.9*	26.9*										
20	26.9*	25.4*										
23	26.9*	23.8		22.3								
26	26.9*	22.5	16.3	22.3								
30	26.7*	21.2	15.7	22.3								
33	24.9*	19.8	14.8	22.3	19.6							
36	22.9	18.7	14.1	22.3	19.0		10.8					
39	21.2	17.6	13.7	21.8	18.3		10.8			9.7		
46	17.9	15.7	12.8	18.7	17.0	14.8	10.8			9.7		
53	15.4	14.3		15.2	15.7	13.9	10.8	10.8		9.7	9.7	
59				12.1	13.7	13.2	10.8	10.6	9.9	9.7	9.7	
66				9.5	11.0	11.9	9.5	9.9	9.5	9.7	9.3	8.8
72				7.3	8.6	9.5	7.7	9.0	9.0	7.5	8.6	8.4
79				5.5	6.6	7.5	6.2	7.3	7.9	5.7	7.1	7.9
85				4.2	5.1	5.7	4.6	5.5	6.6	4.4	5.5	6.4
92				2.9	4.0	4.4	3.3	4.4	5.1	3.1	4.2	5.1
98				2.0	2.6	3.1	2.4	3.1	4.0	2.2	3.1	4.0
105				1.3	1.8	2.2	1.5	2.2	2.9		2.2	2.6
112								1.5	2.0			2.0

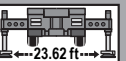
\* With additional lifting equipment / \* Con equipo adicional

     <b>12,125 lbs</b> <span style="float: right;">lbs x 1,000 <b>SAE</b></span>												
 ft	36.4 ft + 59.1 ft			108.9 ft + 59.1 ft			157.2 ft + 59.1 ft			168.0 ft + 59.1 ft		
	0°	20°	40°	0°	20°	40°	0°	20°	40°	0°	20°	40°
10												
12	12.8											
13	12.8											
15	12.8											
16	12.8											
20	12.8											
23	12.8											
26	12.8			9.3								
30	12.8			9.3								
33	12.8	11.7		9.3								
36	12.8	11.0		9.3								
39	12.6	10.6		9.3								
46	11.5	9.7		9.3			6.4					
53	10.4	9.0	7.1	9.3	9.3		6.4			6.0		
59	9.3	8.2	6.6	9.3	9.0		6.4			6.0		
66	8.2	7.5	6.2	9.3	8.6	7.1	6.4	6.4		6.0		
72	7.3	6.8	5.7	8.4	8.4	6.8	6.4	6.4		6.0	6.0	
79	6.6	6.4	5.5	7.1	7.9	6.6	6.4	6.4		6.0	6.0	
85	6.0	6.2		5.5	7.3	6.4	5.3	6.4	6.2	5.1	6.0	5.7
92				4.4	5.7	6.2	4.2	5.7	5.7	4.0	5.3	5.5
98				3.3	4.6	5.5	2.9	4.6	5.3	2.9	4.4	5.3
105				2.4	3.7	4.6	2.2	3.7	4.9		3.3	4.6
112				1.8	2.6	3.7		2.6	3.7		2.4	3.7
118					2.0	2.6		2.0	2.9			2.6
125					1.3	1.8			2.0			

## Lifting capacities / Capacidades de elevación

 <span style="float: right;">lbs x 1,000 <b>SAE</b></span>												
ft	36.4 ft + 32.8 ft			108.9 ft + 32.8 ft			157.2 ft + 32.8 ft			168.0 ft + 32.8 ft		
	0°	20°	40°	0°	20°	40°	0°	20°	40°	0°	20°	40°
10	26.9*											
12	26.9*											
13	26.9*											
15	26.9*											
16	26.9*	26.9*										
20	26.9*	25.4*										
23	26.9*	23.8		22.3								
26	26.9*	22.5	16.3	22.3								
30	26.7*	21.2	15.7	22.3								
33	24.9*	19.8	14.8	22.3	19.6							
36	22.9	18.7	14.1	19.6	19.0		10.8					
39	21.2	17.6	13.7	17.2	18.3		10.8			9.7		
46	17.9	15.7	12.8	14.1	15.2	14.8	10.8			9.7		
53	15.4	14.3		11.2	12.8	13.9	9.3	10.8		9.0	9.7	
59				8.8	10.1	11.7	7.9	9.5	9.9	7.3	8.4	
66				6.6	7.9	9.3	6.2	7.5	8.6	5.7	7.3	8.4
72				4.9	6.2	7.1	4.6	5.7	7.1	4.4	5.5	6.6
79				3.3	4.6	5.3	3.3	4.4	5.3		4.2	5.1
85				2.2	3.1	4.0		3.3	4.2			4.0
92					2.0	2.6			2.9			

\* With additional lifting equipment / \* Con equipo adicional

 <span style="float: right;">lbs x 1,000 <b>SAE</b></span>												
ft	36.4 ft + 59.1 ft			108.9 ft + 59.1 ft			157.2 ft + 59.1 ft			168.0 ft + 59.1 ft		
	0°	20°	40°	0°	20°	40°	0°	20°	40°	0°	20°	40°
10												
12	12.8											
13	12.8											
15	12.8											
16	12.8											
20	12.8											
23	12.8											
26	12.8			9.3								
30	12.8			9.3								
33	12.8	11.7		9.3								
36	12.8	11.0		9.3								
39	12.6	10.6		9.3			6.4					
46	11.5	9.7		9.3			6.4			6.0		
53	10.4	9.0	7.1	9.3	9.3		6.4			6.0		
59	9.3	8.2	6.6	9.3	9.0		6.4			6.0		
66	8.2	7.5	6.2	7.7	8.6	7.1	6.4	6.4		6.0		
72	7.3	6.8	5.7	6.2	8.2	6.8	5.1	6.4		4.9		
79	6.6	6.4	5.5	4.9	6.8	6.6	4.0	5.7				
85	6.0	6.2		3.7	5.3	6.4		4.6	6.2			
92				2.4	4.2	5.3		3.7	5.1			
98					3.1	4.2			4.0			
105					2.2	3.1			2.9			
112						2.2						





A large grid of small squares, intended for taking notes. The grid is composed of approximately 30 columns and 40 rows of squares.

## Axle weight distribution chart / Distribución de pesos por ejes

	Axle Eje	1	2	3	4	Total weight Peso total
	Tires 445/95 R 25 (16.00 R 25) [lbs]		26,455	26,455	26,455	26,455
Tires 525/80 R 25 (20.5 R 25) [lbs]		26,676	26,676	26,676	26,676	106,704*

\* Incl. 14,330 lbs counterweight, 32.8' (10.0 m) / 59.1' (18.0 m) boom extension, hook block, swivel hook.

\* Incl. contrapeso de 6,5 t, 10 m / 18 m plumin, gancho, gancho de bola.

Boom to front	Total [lbs]	Axle 1 [lbs]	Axle 2 [lbs]	Axle 3 [lbs]	Axle 4 [lbs]
Base machine with 16.00 R 25 tires, 8 x 6 drive, no counterweight, no driver, no fuel	85,374	25,655	25,413	17,242	17,063
Fuel in carrier	838	-126	-121	531	554
Fuel in superstructure	419	-20	-19	224	234
Driver in carrier	198	158.4	132.3	-18	-19.7
44.1 ton (40 t)* (3 sheaves) hook block in front (at bumper)	1,213	1,263	1,210	-617	-644
6.6 ton (6 t)* headache ball between axle 2 and 3	331	84	81	81	84
Fly jib	3,193	1,973	1,890	-328	-342
Hydraulically fly jib	3,874	2,680	2,566	-671	-701
Auxiliary winch with cable	2,230	-761	-729	1,820	1,900
Single top	163	196	188	-108	-113
2 <sup>nd</sup> oil cooler	84	-3	-3	44	46
Air conditioning carrier	106	78	75	-23	-24
Drive 8 x 8	746	168	736	-77	-80
20.50 R 25 tires in lieu of 16.00 R 25	882	221	221	221	221
Eddy-current brake	467	0	0	0	467
Tool box at rear	154	-51	-48	124	129

C/w on the upper:					
2,205 lbs (1.0 t)* behind winch (instead of 2nd winch)	2,454	-764	-731	1,932	2,017
2 x 2,205 lbs (1.0 t)*	3,868	-1,058	-1,013	2,905	3,034
5,512 lbs (2.5 t)*	5,261	-1,439	-1,378	3,952	4,127
2,646 lbs (1.2 t)*	2,734	-748	-716	2,054	2,145
5,952 lbs (2.7 t)*	6,002	-1,642	-1,572	4,508	4,708
C/w on the carrier:					
2,205 lbs (1.0 t)*	2,315	1,043	999	134	140
6,393 lbs (2.9 t)*	6,434	2,899	2,776	372	388
9,700 lbs (4.4 t)*	9,702	4,371	4,185	561	585
10,141 lbs (4.6 t)*	10,214	4,601	4,406	590	616

\* Metric

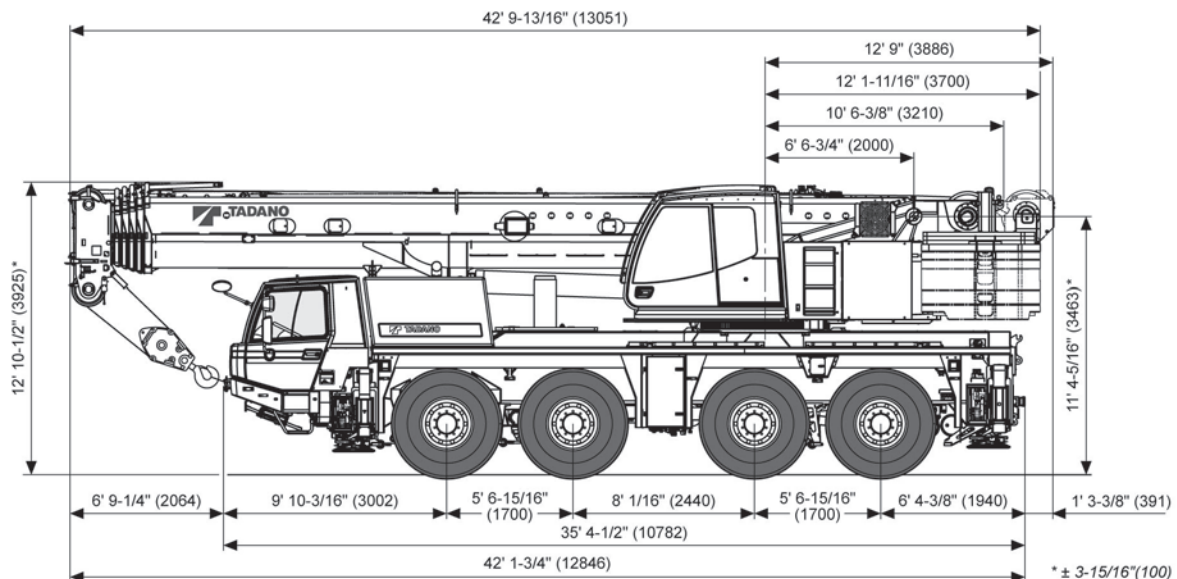

## Axle weight distribution chart / Distribución de pesos por ejes

<b>Boom in dolly, 29.2 ft behind boom pivot point</b>	<b>Total</b> [lbs]	<b>Axle 1</b> [lbs]	<b>Axle 2</b> [lbs]	<b>Axle 3</b> [lbs]	<b>Axle 4</b> [lbs]	<b>Dolly</b> [lbs]
Base machine with 16.00 R 25 tires, 8 x 6 drive, no counterweight, no driver, no fuel	85,374	19,812	19,816	15,893	15,656	14,197
Fuel in carrier	838	-126	-121	531	554	0
Fuel in superstructure	419	94	90	114	120	0
Driver in carrier	198	158.4	132.3	-18	-19.7	0
6.6 ton (6 t)* headache ball between axle 2 and 3	331	84	81	81	84	0
44.1 ton (40 t)* (3 sheaves) hook block at boom head	1,213	-100	-96	-51	-53	1,513
Fly jib	3,193	307	294	157	164	2,271
Hydraulically fly jib	3,874	285	273	146	152	3,018
Auxiliary winch with cable	2,230	1,156	1,107	-16	-17	0
Single top	163	-14	-13	-7	-7	205
2 <sup>nd</sup> oil cooler	84	18	17	24	25	0
Air conditioning carrier	106	78	75	-23	-24	0
Drive 8 x 8	746	168	736	-77	-80	0
20.50 R 25 tires in lieu of 16.00 R 25	882	221	221	221	221	0
Eddy-current brake	467	0	0	0	467	0
Tool box at rear	154	-51	-48	124	129	0

C/w on the upper:						
2,205 lbs (1.0 t)* behind winch (instead of 2nd winch)	2,454	1,198	1,147	53	56	0
2 x 2,205 lbs (1.0 t)*	3,868	1,742	1,668	223	233	0
5,512 lbs (2.5 t)*	5,261	2,370	2,270	304	317	0
2,646 lbs (1.2 t)*	2,734	1,232	1,179	158	165	0
5,952 lbs (2.7 t)*	6,002	2,704	2,589	347	362	0
C/w on the carrier:						
2,205 lbs (1.0 t)*	2,315	1,043	999	134	140	0
6,393 lbs (2.9 t)*	6,434	2,899	2,776	372	388	0
9,700 lbs (4.4 t)*	9,702	4,371	4,185	561	585	0
10,141 lbs (4.6 t)*	10,214	4,601	4,406	590	616	0

\* Metric

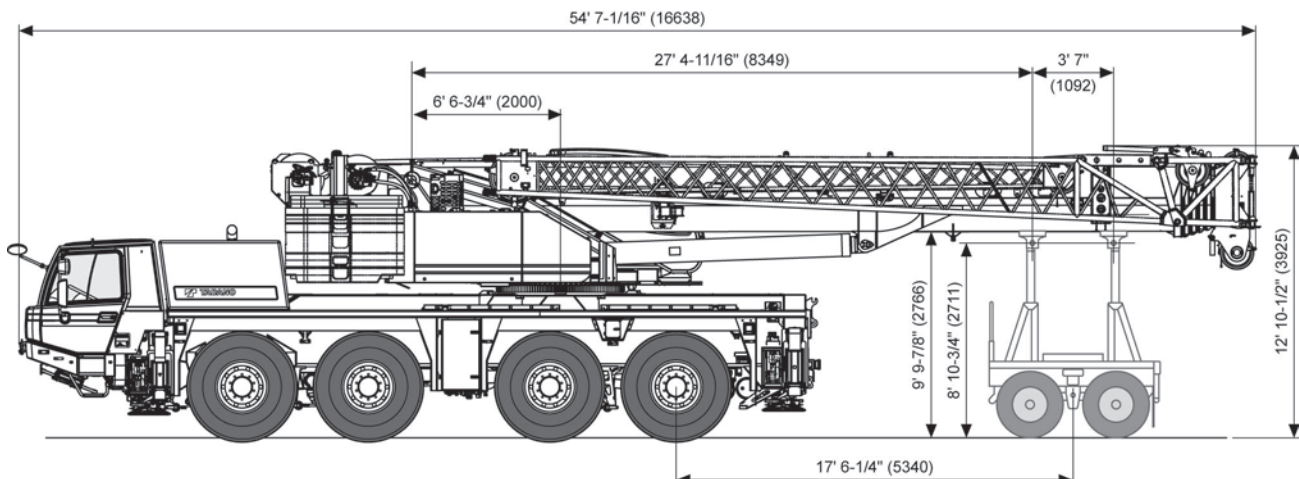

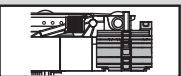
	Counterweight Contrapeso	1x	1x	1x	1x	1x	1x	1x	1x	1x	1x
		①	②	③	④	⑤	⑥	⑦	⑧	⑨	⑩
	[lbs]	2,205	2,205	2,205	5,512	5,952	2,646	9,700	10,141	6,393	2,205

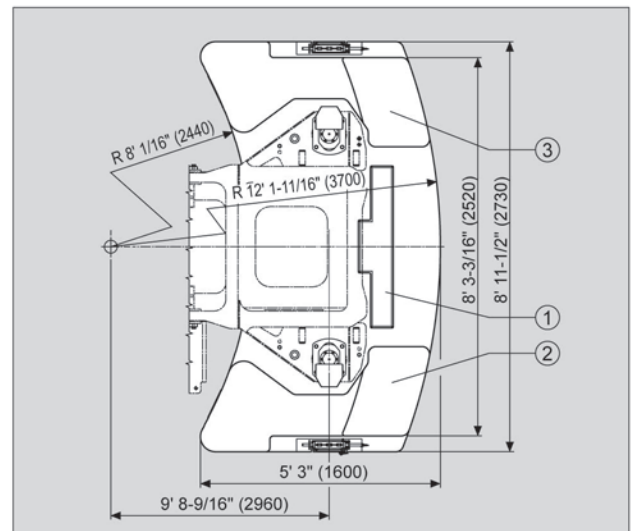
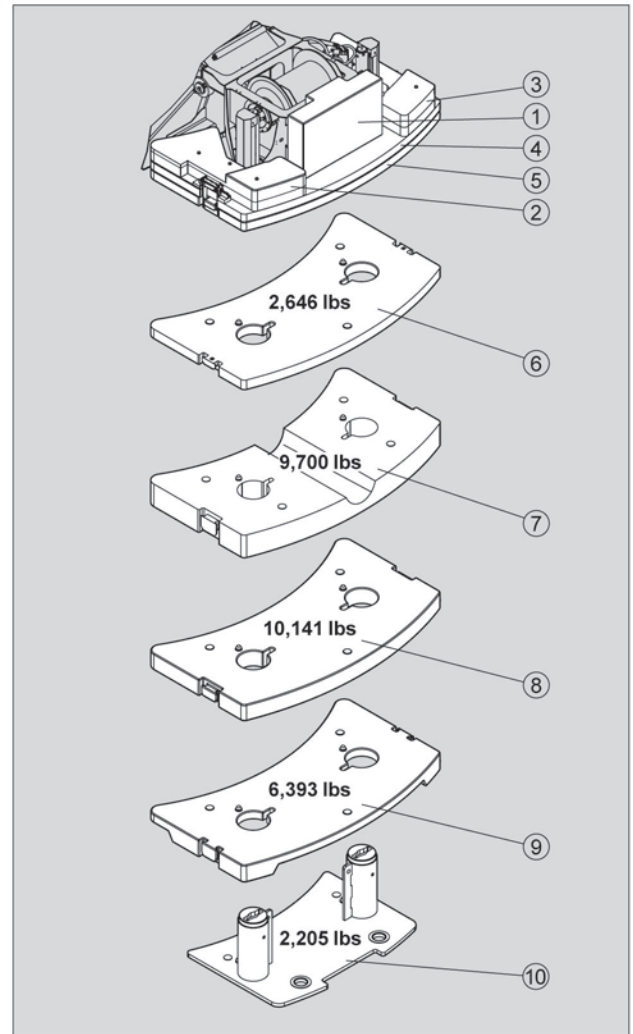
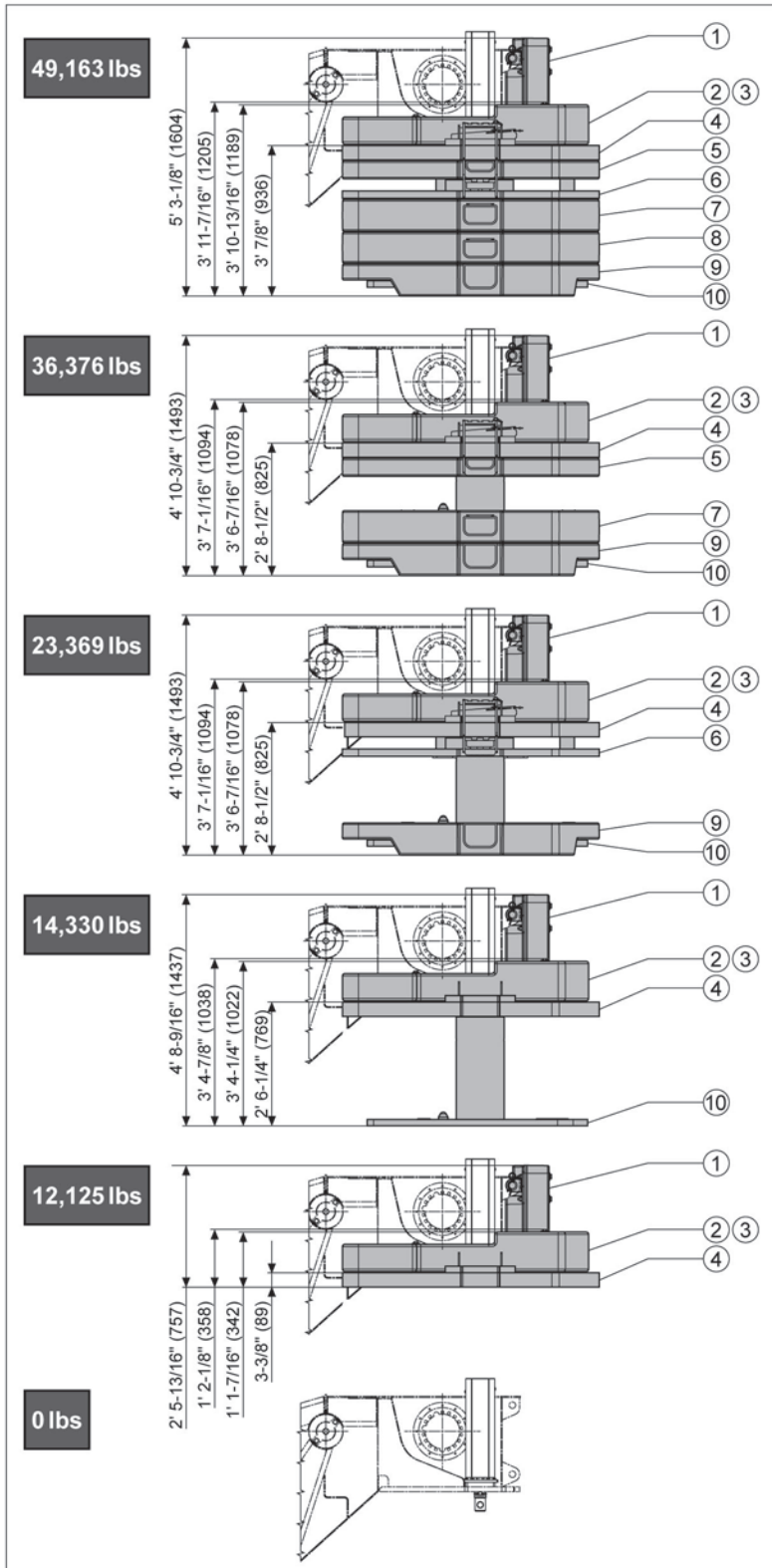

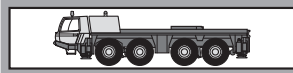

**Frame** Torsion-resistant, welded construction made from high strength, fine grained steel.

**Outriggers** 4 point, double telescopic hydraulic outriggers with controls on both sides of carrier and in superstructure cab. Outrigger base 23' 7-7/16" (7.2 m) {16' 4-7/8" (5.0 m) mid extension} x 28'-1/4" (8.54 m).

**Carrier engine** Mercedes-Benz 6 cylinder model OM 501 LA (Euromot III b/Tier 4i), water-cooled diesel engine. Rated at 435 hp (320 kW) at 1,800 rpm. Torque 1548.87 ft-lbs (2,100 Nm) at 1,300 rpm. Engine rating according to 80/1269/EWG. Fuel tank 105.67 gal (400 l). DEF tank 10.57 gal (40 l).

**Transmission** ZF-AS-Tronic 12 AS 2302 mechanical transmission with integrated interarder, electro-pneumatically operated dry-type clutch and automatic gear shifting with 12 forward gears and 2 reverse gears. Power/Economy modes.

**Transfer Case** Two stage.

**Drive** 8 x 6 (8 x 8 optional)

### Axles

1<sup>st</sup> axle: steered, not driven.  
 2<sup>nd</sup> axle: steered, driven, with transverse differential lock.  
 3<sup>rd</sup> axle: steered, driven, with transverse and longitudinal differential lock.  
 4<sup>th</sup> axle: steered, driven, with transverse differential lock.

**Suspension** Hydro-pneumatic with levelling adjustment.

**Brake system** Service brakes: dual circuit compressed air system. Parking brake: spring loaded type acting on 2<sup>nd</sup>, 3<sup>rd</sup> and 4<sup>th</sup> axles. Auxiliary brakes: interarder, engine exhaust brake and constant throttle engine brake system.

**Tires** (8) 445/95 R 25 (16.00 R 25), width 9' 1/4" (2.75 m).  
 (8) 525/80 R 25 (20.5 R 25), width 9' 8-15/16" (2.97 m).

**Steering system** ZF-Servocom, dual circuit hydraulic steering with emergency steering pump, mechanical hydraulically-assisted steering of front two axles and automatic steering of the 4<sup>th</sup> axle up to a travel speed of 15.5 mph (25 km/h). Steering of all axles possible. All axles steered hydrostatically from superstructure cab.

**Carrier cab** Two-man, full width cab of composite (steel sheet metal and fibre-glass) structure, with safety glass, air-cushioned adjustable seats (driver seat with heater) and engine based water heater, radio/CD-player, complete controls and instrumentation for road travel. Cruise control with hill braking feature functions.

**Electrical system** 24 volt DC system, 2 batteries, outrigger area lighting. Electrical system conforms with European standard regulations.

### Optional Equipment (at extra charge)

Towing attachment, engine independent additional heater with engine pre-heat, air conditioning, 8 x 8 drive, 525/80 R 25 (20.5 R 25) tires, spare wheel and tire, special painting and lettering.

Further optional equipment available upon request.

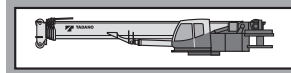

**Frame** Torsion-resistant, all-welded structure of high strength steel. Connected to carrier by single-row, ball-bearing slewing ring with external gearing for 360° continuous rotation.

**Superstructure engine** Mercedes-Benz 4 cylinder model OM 924 LA (Euromot III b/Tier 4i), water cooled, diesel engine. RPM infinitely variable via foot pedal, rating 173 hp (127 kW) at 2,000 rpm. Torque 497.85 ft-lbs (675 Nm) at 1,200 - 1,600 rpm. Engine rating according to 80/1269/EWG. Fuel tank 58.12 gal (220 l). DEF tank 2.11 gal (8 l).

**Hydraulic system** Three circuit diesel hydraulic system with 1 power controlled double axial piston pump (electrically adjustable), 1 axial piston pump and 2 gear pumps, oil cooler.

**Controls** Electrical, 2 joy-stick levers for simultaneous operation of crane motions.

**Telescopic boom** 6 sections, made of high tensile, fine-grained steel, consisting of 1 base section and 5 telescoping sections extended by means of a single telescopic cylinder. All telescope sections extendable under partial load. 36.4 ft (11.1 m) to 168.0 ft (51.2 m) long. Boom head with 7 sheaves.

**Derricking system** 1 double acting hydraulic cylinder with integral brake and holding valve.

**Main winch** Axial piston motor, winch drum with integrated planetary reduction and hydraulically controlled spring-loaded multiple disc brake and integrated free rotation (no sagging of load when hoisting). Hoist cable with 'Super-Stop' easy reeving system.

**Slewing system** Axial piston motor with two-stage planetary gear equipped with a foot actuated service and a parking brake. Speed infinitely variable 0 - 2 rpm.

**Counterweight** Standard 14,330 lbs divisible, assembled and disassembled by hydraulic cylinders controlled from superstructure cab.

**Superstructure cab** Spacious panoramic cab of composite structure with safety (tinted) glass windows, tiltable cockpit with hydraulically cushioned adjustable seat with heater, engine independent heater with engine pre-heat, air conditioning, radio/CD-player, complete controls and instrumentation for crane operation, on-site travelling and outriggers.

**Electrical system** 24 volt DC system, 2 batteries.

**Safety devices** Load moment device (LMD), working area limiter, hoist limit switch, lower limit switch and drum turn indicator, safety valves against pipe and hose rupture, holding valves on hydraulic cylinders.

### Optional Equipment (at extra charge)

'Lift Adjuster', Boom extension 32.8' (10.0 m)/59.0' (18.0 m), offsets 0°, 20° and 40° or hydraulically 0°- 40°, heavy duty jib 5.2' (1.6 m), additional counterweight 34,833 lbs, counterweight variations 0 lbs / 12,125 lbs / 23,369 lbs / 36,376 lbs / 49,163 lbs, selection of hook blocks, auxiliary winch, slewing area limitation, additional oil cooler, special painting and lettering.

Further optional equipment available upon request.

## Equipo

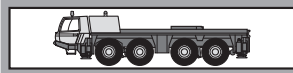

**Chasis portante** Construcción de acero de alta resistencia soldado, resistente a la torsión y a la flexión.

**Estabilizadores** Estabilizadores hidráulicos de 4 puntos. Posibilidad de manejo desde ambos lados del chasis portante y desde la cabina de la grúa. Extensión de los estabilizadores: 7,2 m (y 5,0 m) x 8,5 m.

**Motor** Mercedes-Benz modelo OM 501 LA (Euromot III B / EPA Tier 4i), 6 cilindros, diesel, refrigerado por agua. Nominal 320 kW (435 CV) a 1800 min<sup>-1</sup>. Par 2100 Nm a 1300 min<sup>-1</sup>. Potencia del motor según 80/1269/EWG. Depósito de combustible de 400 l. Depósito AdBlue 40 l.

**Transmisión** Transmisión mecánica tipo ZF-AS Tronic modelo 12 AS 2302 con intarder integrado, accionamiento electro-neumático embrague en seco y cambio automático, 12 marchas delanteras y 2 marchas traseras. Modo rendimiento máximo / económico.

**Transmisión** Caja de distribución (transfer) con 2 relaciones de velocidad.

**Tracción** 8 x 6 (8 x 8 opción).

### Ejes

- 1º eje: de dirección, no accionado.
- 2º eje: de dirección, accionado, con bloqueo diferencial transversal.
- 3º eje: de dirección, accionado, con bloqueo diferencial transversal y longitudinal.
- 4º eje: de dirección, accionado, con bloqueo diferencial transversal.

**Suspensión** Suspensión hidroneumática con regulación de nivel.

**Sistemas de frenos** Accionamiento neumático de doble circuito con sistema anti bloqueo ABS. Freno de estacionamiento del tipo muelles cargados, liberados por aire, sobre los ejes 2º, 3º y 4º. Intarder y freno continuo: sistema estrangulador constante y freno tipo estrangulación sobre el escape del motor diesel.

**Neumáticos** 8 x 445/95 R 25 (16.00 R 25), (ancho 2,75 m).  
8 x 525/80 R 25 (20.5 R 25), (ancho 2.97 m).

**Dirección** Hidráulica ZF Servocom de doble circuito. Dirección mecánica del 1º y 2º eje y direccionable del 4º eje hasta una velocidad de 25 km/h, con bomba hidráulica de emergencia accionada por la transmisión. Dirección de todos los ejes posible. Desde la cabina de la superestructura: dirección hidro-estática de ambos ejes.

**Cabina** Cabina para dos personas, en construcción de acero y fibra de vidrio. Cristales de seguridad, asiento con suspensión neumática, asiento de conductor calefactado. Calefacción por agua caliente del motor, radio-CD-player. Elementos de control y manejo para circular por carretera. Regulador de velocidad, sistema automático de frenado.

**Sistema eléctrico** Sistema de 24 V c.c. con 2 baterías, faros de trabajo en los estabilizadores. El sistema eléctrico cumple la normativa CEE.

**Equipo adicional** (con suplemento de precio)  
Embrague de remolque, calefacción adicional con precalefacción del motor, climatización, Tracción 8 x 8, neumáticos 525/80 R 25 (20.5 R 25), rueda de repuesto, pintura especial y rotulación.  
Otros equipamientos sobre pedido.

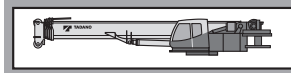

**Superestructura** Construida en aceros soldados, resistente a la torsión. Corona de giro con rodamiento de una fila de bolas con dientes externos para giro continuo de 360°.

**Motor** Mercedes-Benz modelo OM 924 LA (Euromot III B / EPA Tier 4i), 4 cilindros, diesel, refrigerado por agua. Las revoluciones aumentan de forma gradual accionando el acelerador. Nominal 127 kW (173 CV) a 2000 min<sup>-1</sup>. Par 675 Nm a 1200 - 1600 min<sup>-1</sup>. Potencia del motor según 80/1269/EWG. Depósito de combustible de 220 l. Depósito AdBlue 8 l.

**Sistema hidráulico** Sistema hidráulico de 3 circuitos, 1 bomba doble de pistones axiales de caudal variable (regulable eléctricamente) una bomba de pistones axiales y 2 bombas en tandem, enfriador de aceite.

**Mandos** 2 palancas de control de tipo joy-stick para movimientos simultáneos de la grúa (4 direcciones), asistidos eléctricamente.

**Pluma telescópica** 6 secciones, un tramo base y 5 telescópicos de acero de alta resistencia soldado, 1 cilindro hidráulico, los tramos se pueden telescopar hidráulicamente bajo carga. Longitud de 11,1 m a 51,2 m. Cabeza de pluma con 7 poleas.

**Elevación de pluma** Mediante un cilindro hidráulico de doble efecto con válvula de retención integrada.

**Cabrestante principal** Motor hidráulico de pistones axiales y caudal fijo. Tambor del cabrestante con reducción planetaria y frenos de disco múltiples accionado, con sistema libre de elevación. Cable de elevación con sistema fácil de guiado y 'Super-Stop'.

**Sistema de giro** Motor hidráulico de pistones axiales con reducción planetaria de dos etapas. Freno de servicio controlado por pedal y freno de estacionamiento. Velocidad de giro variable de 0 a 2 min<sup>-1</sup>.











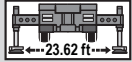
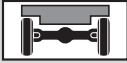
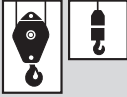

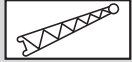

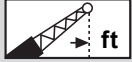

**Contrapeso** El estándar 6,5 t divisible, se acciona desde la cabina de la grúa.

**Cabina de la grúa** Cabina espaciosa y confortable, en construcción de acero y fibra de vidrio, con cristales tintados de seguridad. Asiento de operador regulable amortiguado hidráulicamente, inclinable junto con los instrumentos y mandos, asiento calefactado. Calefacción independiente del motor y precalefacción del motor, climatización, radio/CD-player. Controles, instrumentos y mandos de conducción para la operación de la grúa y para el desplazamiento en obra. Mandos para nivelación y extensión de los estabilizadores.

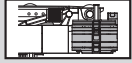
**Sistema eléctrico** Sistema de 24 V c.c. con 2 baterías.

**Medidas de seguridad** Limitación del momento de carga (LMC), limitación del área de trabajo, interruptor de final de elevación, interruptor de 3 últimas vueltas en cabrestante, indicador de bajada o subida del cable del cabrestante, válvulas de seguridad para rotura de tubos y latiguillos. Válvulas de retención en los cilindros hidráulicos.

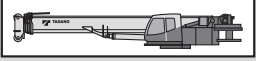
**Equipo adicional** (con suplemento de precio)  
'Lift Adjuster', plumín de 10,0 m / 18,0 m regulable hidráulicamente de 0°, 20° y 40° (o hidráulicamente 0° a 40°), plumín de carga pesada de 1,6 m, contrapeso adicional de 15,8 t, variantes de contrapeso 0 t / 5,5 t / 10,6 t / 16,5 t / 22,3 t, selección de ganchos, 2º cabrestante, limitador de giro, enfriador adicional, pintura especial y rotulación.  
Otros equipamientos sobre pedido.

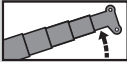
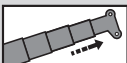
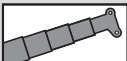
 <b>525/80 R 25</b> (20.5 R 25)	Tires / Size Neumáticos / Tamaño de ruedas		Outriggers Estabilizadores
	Axle load Carga por eje	<b>49,163 lbs</b>	Counterweight Contrapeso
	Hook block / Swivel hook Gancho / Gancho de bola		Radius Radio
<b>V+</b> 	Carrier speeds Velocidades del chasis		Boom extension Plumín
	Transmission / Gear Transmisión / Marchas		Boom extension hydraulically Plumín hidráulicamente
	Gradeability Superacion de pendientes		Radius Radio
	Off road Todo terreno		Over rear Sobre la parte trasera
	On road En carretera		Counterweight versions Variaciones de contrapeso
<b>V+</b> 	Superstructure speeds Velocidades de la superestructura		Carrier Chasis
	Main winch Cabrestante principal		Superstructure Superestructura
	Auxiliary winch 2° cabrestante	<b>SAE</b>	The data are for basic information only and the operator's manual must be consulted before operating this crane. All data and performances refer to the standard crane. The addition of optional and other equipment may affect the performance of the crane.
	Slewing system Sistema de giro	Los datos sirven solamente para su información. Hay que leer las instrucciones para el uso antes de la puesta en servicio de la máquina. Todos los datos mencionados en las presentes tablas rigen para los modelos standard. Cualquier modificación del equipo montado puede dar lugar a modificaciones de aquellos valores.	
	Derricking system Elevación de pluma		
	Boom telescoping Telescopaje de pluma		
	Telescopic boom Pluma telescópica		



**TADANO AMERICA Corporation**

4242 West Greens Road, Houston, TX 77066

Phone: 281-869-0030 Fax: 281-869-0040

www.tadanoamerica.com E-mail: sales@tadano-cranes.com

Parts Hotline: 281-869-0033 Service Hotline: 281-869-5925

01/VII 2013

Printed in U.S.A

*Courtesy of Crane.Market*