

GEISTER®

Hand
Surgery

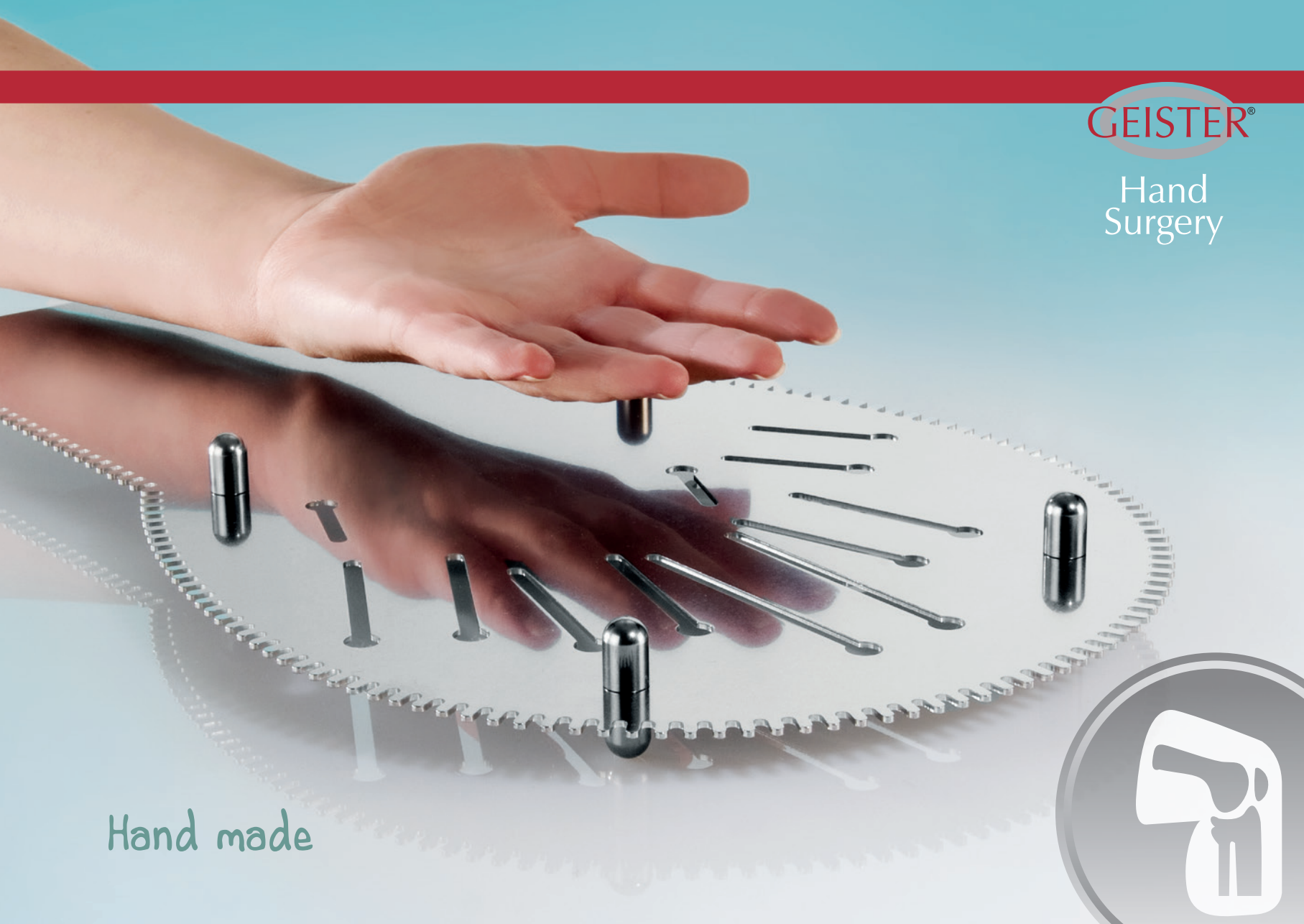

Hand made





Hand Surgery

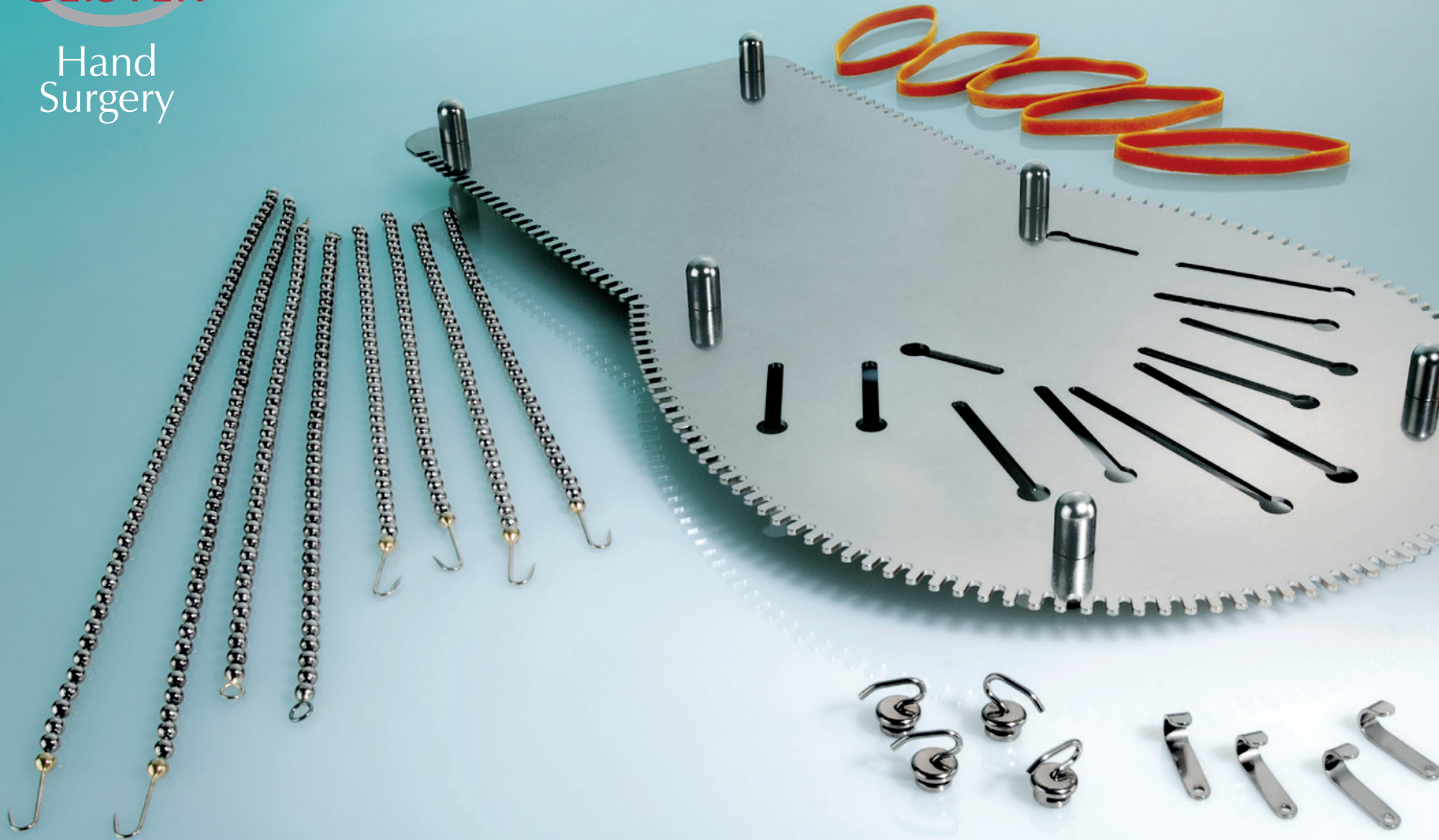



Product search

In our new Online-Catalog you can find over 9000 specialty surgical instruments for the fields **CARDIO**, **NEURO**, **POWERED** and **JOINTS** surgery. Search systematically for specific product codes, keywords or reference numbers or click through the various index areas. Using the bookmark function, you can generate your individual product list, which you can print or save or fast and easily request a quote. – www.geister.com –

Our hands are our tools. Our surgical tools help to restore hands.

Hand Surgery has particularly developed in the last ten years. Our hands are our tools for every activity we complete in our day. They help us to eat, write, work, dress, create something etc.. To achieve this, proper joint motion, tendon gliding and muscle contraction are necessary. When they are affected by conditions such as arthritis, carpal tunnel syndrome or injuries, our daily life is impacted. To restore their function the surgeon has to deal with different types of tissues.

Hand microsurgeries require professionalism and competence as well as the most precise and delicate surgical instrumentation. Our universal hand holders and retractors enable the surgeon to fixate the hand in any position needed with ball chains of varying lengths or tendon or skin hooks. With the patient's hand positioned firmly, the surgeon can operate precisely and unhindered beneath a microscope with our special nano- and microsurgical instrumentation for hand surgery.

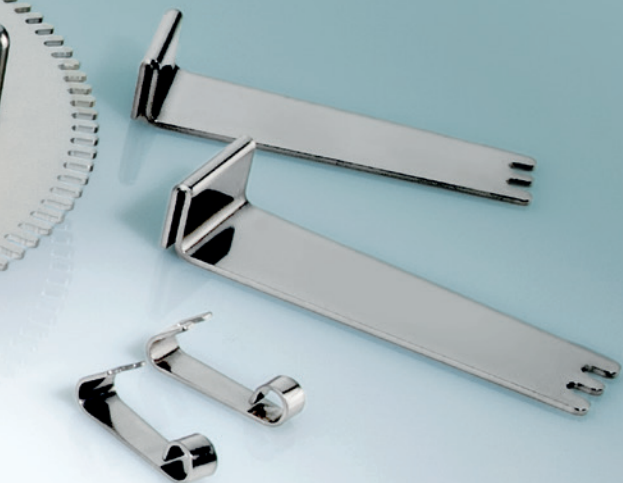



Hand Surgery

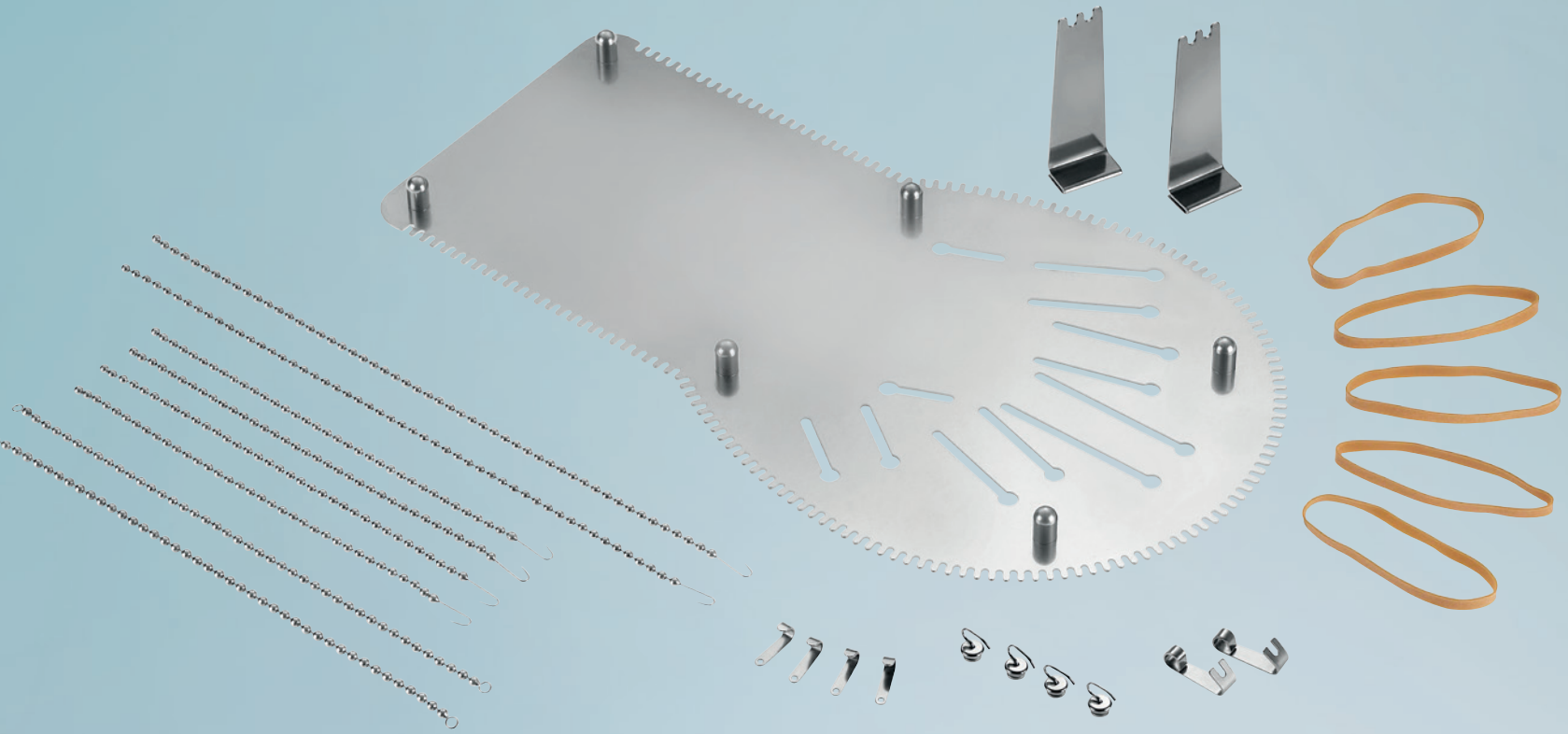

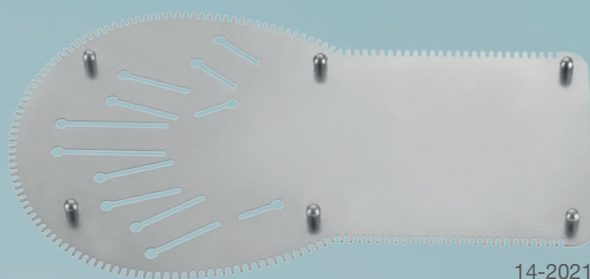

14-2021



14-2022



14-2023



14-2024



14-2025

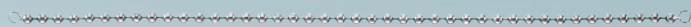

14-2026



14-2027



14-2028



14-2029

Universal Hand Holder and Retractor Set complete with all accessories

- 14-2020 Universal Hand Holder and Retractor Set complete with all accessories
- 14-2021 Hand Table suitable for 14-2020
- 14-2022 Elevated chain holders, 2 pieces, suitable for 14-2020
- 14-2023 Chain holder hooks, 2 pieces, suitable for 14-2020
- 14-2024 Ball chains, 2 pieces, 32 cm, with skin-hooks, suitable for 14-2020
- 14-2025 Ball chains, 4 pieces, 21cm , with skin-hooks, suitable for 14-2020
- 14-2026 Ball chains, 2 pieces, 26 cm, for arm and wrist fixation, suitable for 14-2020
- 14-2027 Tendon hooks, 4 pieces, 5,0mm width, suitable for 14-2020
- 14-2028 Sliding hooks, 4 pieces, for the rubber bands, suitable for 14-2020
- 14-2029 1 set rubber bands (5 pieces) suitable for 14-2020
- additional for accessoires:
- 14-2032 Box, oval, 130 x 100 mm only for accessoires from 14-2020 (not illustrated)



Hand
Surgery

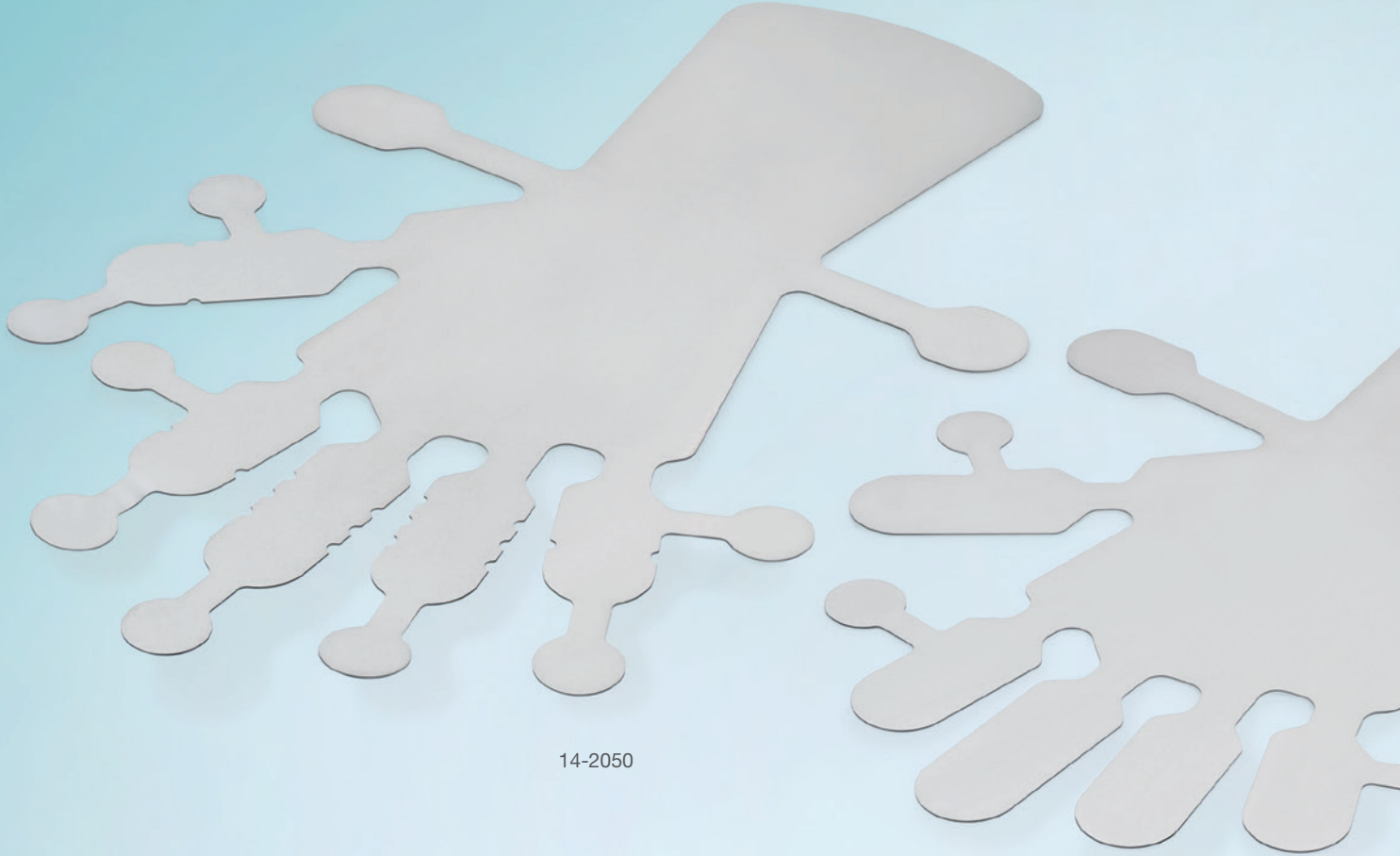

14-2050



14-2051



14-2060

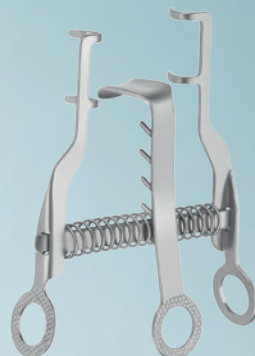

14-2061

- 14-2051 Fixation Hand, Stainless steel 0,8 mm for interoperative Fixation, quickly and easily bent in any direction
- 14-2050 Fixation Hand, Stainless steel 0,8 mm for interoperative Fixation, quickly and easily bent in any direction, with 5 additional fixation possibilities
- 14-2060 Vickers finger wound spreader
2x2 hooks, blunt
- 14-2061 Vickers hand/arm wound spreader
2x2 hooks, blunt, with centre blade for hand and carpal tunnel
- 14-2062 Vickers hand/arm wound spreader
3x3 hooks, blunt, with centre blade for hand and for arm
- 14-2063 Vickers hand/arm wound spreader
blunt, with centre blade, for snapping fingers and small incisions



Hand
Surgery



14-2101



14-2110





14-2150



- 14-2101 Reposition forceps with 2 K-wire pins
0,8 and 1,0 mm Ø, 14,5 cm
for percutaneous application
- 14-2110 Reposition forceps 13,5 cm
for reduction of hard to reach fractures
- 14-2150 Repositions pliers 16 cm, for K-wire
Ø 1,6 mm for reduction of scaphoid
and lunate
- 14-2151 dto. for K-wire Ø 2,0 mm



Hand
Surgery





Basic Reconstructive Surgery Set

01-1650	Set complete
03-0090	Scissors round handle Ø 8 mm/ Length 150 mm, straight
03-0091	Scissors round handle Ø 8 mm/ Length 150 mm, curved
03-0112	Needle Holder round handle Ø 8 mm/ Length 150 mm, curved
10-3020	Forceps round handle Ø 8 mm/ Length 150 mm, straight
10-3023	Forceps round handle Ø 8 mm/ Length 150 mm, straight Pierce bore Ø 0.3 mm
10-3038	Forceps round handle Ø 8 mm / Length 150 mm, curved
10-3200	Dilator 110 mm, 10° angulated
75-0072	Applying Forceps 140 mm, straight
75-0398	Single Clamps, #2, 0.6-1.4 mm, 2 pieces/package
75-0400	Single Clamps, #3, 1.0-2.2 mm, 2 pieces/package
75-0325	Single Clamps, #4, 1.5-3.3 mm, 2 pieces/package
75-0416	Double Clamps, #2, 0.6-1.4 mm, 1 pieces/package
75-0418	Double Clamps, #3, 1.0-2.2 mm, 1 pieces/package
75-0326	Double Clamps, #4, 1.5-3.3 mm, 1 pieces/package
77-0090	Instrument Case 130x230x25 mm
77-0091	Rack for 8 Instruments with Clamp Box

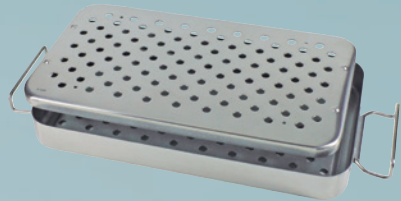

77-0090

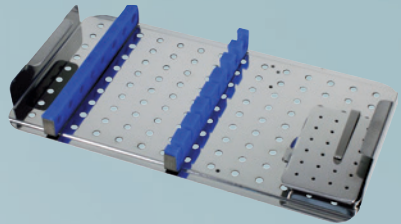

77-0091



03-0112

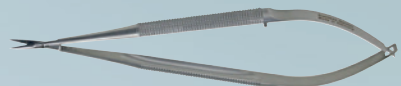

03-0090

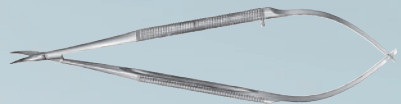

03-0091



10-3038



10-3020



10-3023



10-3200



75-0072



75-0398



75-0416



75-0400



75-0418



75-0325



75-0326



Hand Surgery

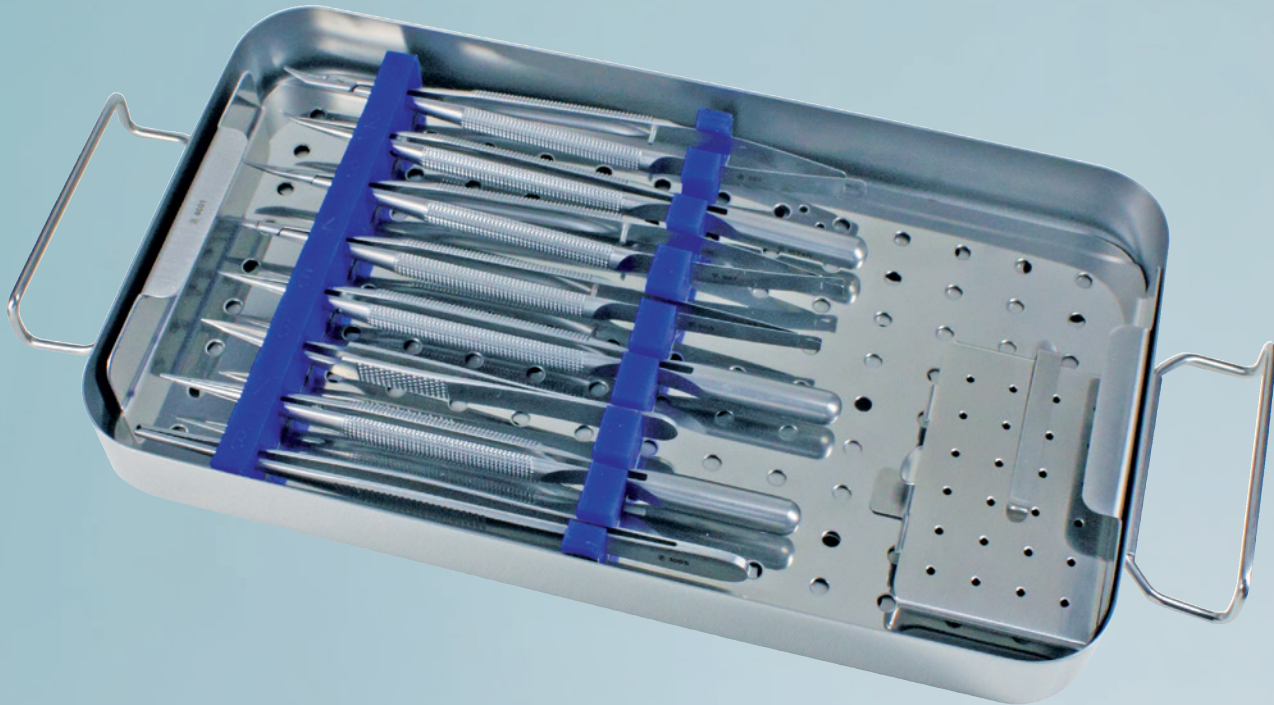

01-1651



10-3023.G
The forceps,
with ends
counter balanced

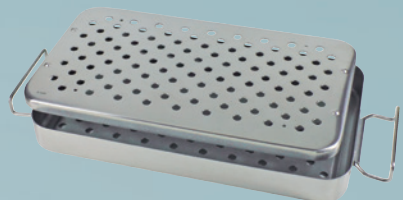

77-0090

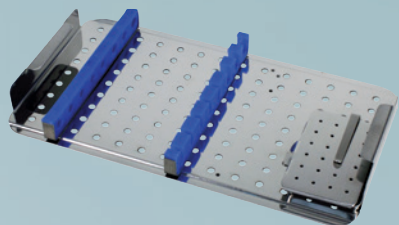

77-0091

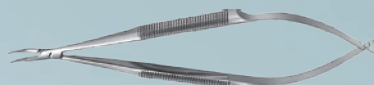

03-0112

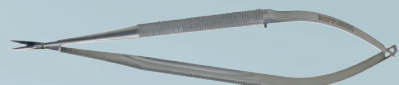

03-0090

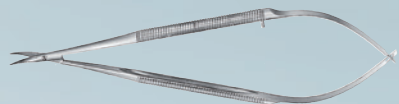

03-0091



10-3038.G



10-3020.G



10-3023.G



10-3200



75-0072



75-0398



75-0400



75-0410



75-0412

Basic Hand Surgery Set

- | | |
|-----------|---|
| 01-1651 | Set complete |
| 03-0090 | Scissors round handle Ø 8 mm / Length 150 mm, straight |
| 03-0091 | Scissors round handle Ø 8 mm / Length 150 mm, curved |
| 03-0112 | Needle Holder round handle Ø 8 mm / Length 150 mm, curved |
| 10-3020.G | Forceps round handle Ø 8 mm / Length 150 mm, straight |
| 10-3023.G | Forceps round handle Ø 8 mm / Length 150 mm, straight
Pierce bore Ø 0.3 mm |
| 10-3038.G | Forceps round handle Ø 8 mm / Length 150 mm, curved |
| 10-3200 | Dilator 110 mm, 10° angulated |
| 75-0072 | Applying Forceps 140 mm, straight |
| 75-0398 | Single Clamps, #2, 0.6-1.4 mm, 2 pieces/package |
| 75-0400 | Single Clamps, #3, 1.0-2.2 mm, 2 pieces/package |
| 75-0410 | Double Clamps, #2, 0.6-1.5 mm, 1 pieces/package |
| 75-0412 | Double Clamps, #3, 1.0-2.25 mm, 1 pieces/package |
| 77-0090 | Instrument Case 130x230x25 mm |
| 77-0091 | Rack for 8 Instruments with Clamp Box |



75-1000

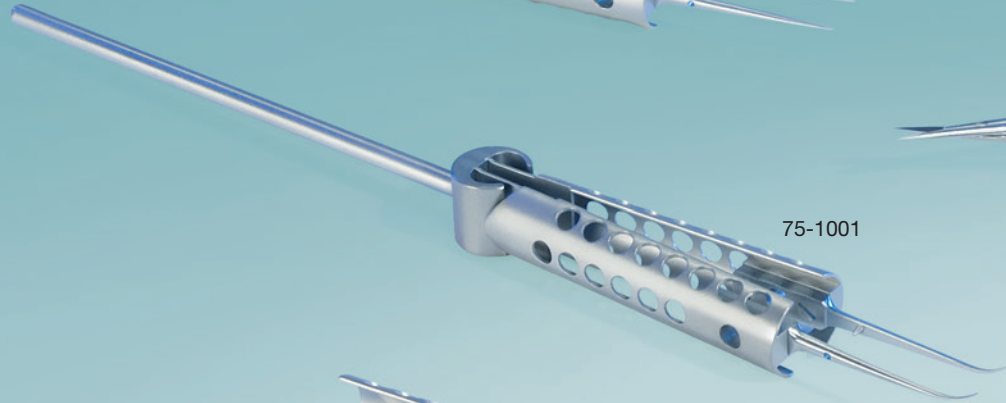

75-1001



75-1101



Structurae™ Nano Instruments



- Ultra-fine instruments for micro vessel-, nerve- and hand-surgery
- Maximum control and precision through ergonomic perforated handle
- Perfect balance and firm position in the hand through stabilization rod
- Even lighter than most titanium instruments

Structurae™ Nano Tying Forceps

75-1000	15 cm straight
75-1001	15 cm curved

Structurae™ Nano Scissors

75-1100	15 cm straight
75-1101	15 cm curved

Structurae™ Nano Needle Holders

75-1200	15 cm straight
75-1201	15 cm curved

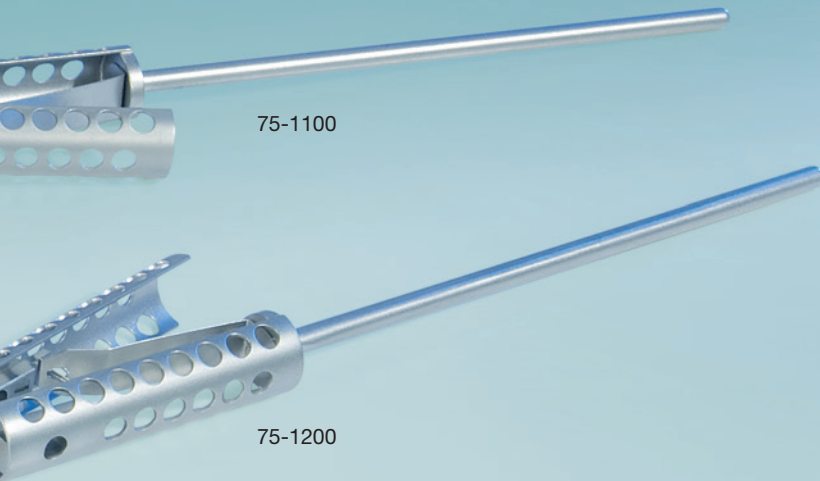

75-1100

75-1200

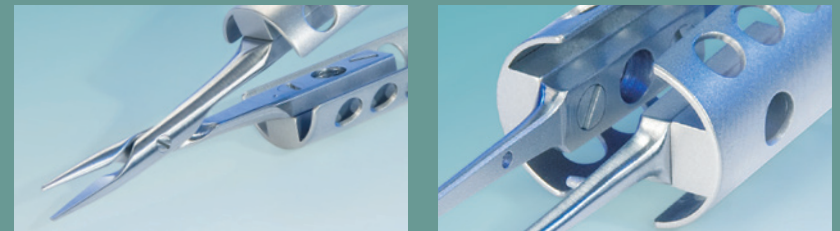
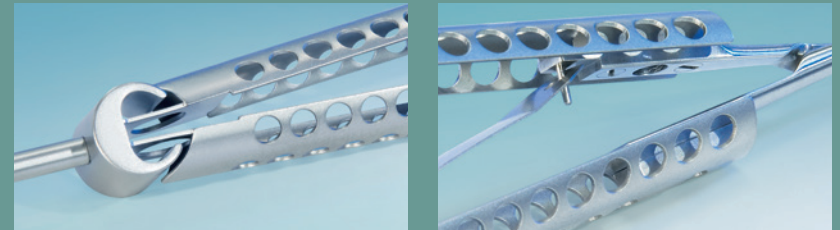



GEISTER Medizintechnik GmbH

Föhrenstrasse 2 | D-78532 Tuttlingen | Germany

☎ +49 7461/966240 | 📠 +49 7461/9662422

www.geister.com | info@geister.com