

**PROFESSIONAL
LED SIGNAGE
LED LIGHTING**



CHINA • ENPING ZERO ONE SIGNAGE CO.,LTD

Since 2008

We will provide you with better products and services as always.

If you need more detailed product catalog, please visit our website : www.zeronesign.com.

V.2018.0301



LED SIGNAGE SERIES

精雕细刻 别具匠心

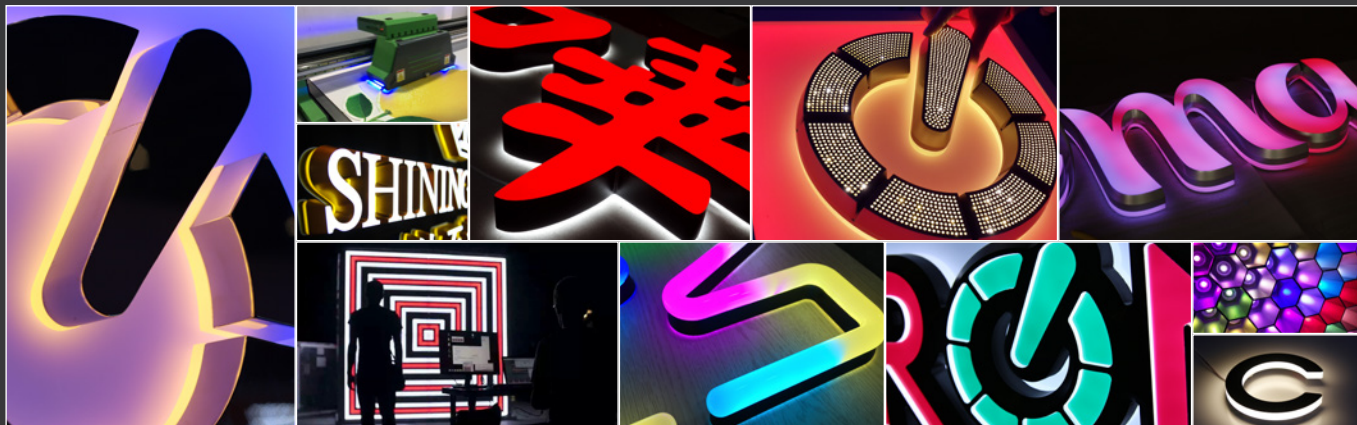

About ZERONEsign

ZERONEsign, leading manufacturer of signage system manufacturing services. We focus on signage process and research and development of technology. We focus on design, product manufacturing and application services. We provide customized and optimized application solutions for commercial space brand signage system. ZERONEsign has more than 10 years of market operation experience and professional R&D background in the signage field. We are dedicated to the quality, function, beauty and detail of the product and we are committed to meet the high quality and personalized product service demand.



零壹标识专注为您提供稳定性极高的产品



SINCE 2008

Professional signage manufacturer
Focus on chain store signage

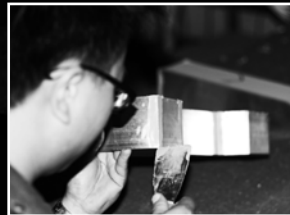



LED SIGNAGE SERIES / LED 发光字

Full acrylic letters
Channel letters
Neon letters
Diamond letters
LED bulb letters

全亚克力发光字
金属围边发光字
霓虹管发光字
钻石发光字
外露灯发光字

LED LIGHTING SERIES / LED 灯饰

LED module
LED light box
Custom lighting

发光字模组
灯箱
工程定制类灯饰
演出及夜场定制灯饰



LED BACKLIGHT SERIES / LED 背光源

Lamp LED backlight
SMD LED backlight

插件灯背光源
贴片灯背光源

DISPLAY MODULE SERIES / 显示模块

Simulation LCM module
LED display

仿真液晶显示模块
数码管显示模块

该类型产品仅应用于电声行业无线话筒的发射与接收显示



Full acrylic letters 全亚克力发光字



Lumi letters (Vertical side)
直边亚克力发光字

The best size : 100mm - 400mm

Application : indoor / outdoor

Size : 60mm - 800mm

Depth : 10mm - 40mm



Mini letters (Bevel side)
斜边迷你发光字

The best size : 40mm - 200mm

Application : indoor / outdoor

Size : 20mm - 800mm

Depth : 15mm - 40mm

Channel letters 金属围边发光字



Channel letters
金属围边发光字

The best size : 150mm - 1200mm

Application : indoor / outdoor

Size : 100mm - 2000mm

Depth : 30mm - 150mm

LED bulb letters 外露灯发光字



LED bulb letters
外露灯发光字

The best size : 200mm - 1200mm

Application : indoor / outdoor

Size : 100mm - 2000mm

Depth : 30mm - 150mm

Diamond letters 钻石发光字



Diamond letters
钻石发光字

The best size : 100mm - 400mm

Application : indoor / outdoor

Size : 60mm - 800mm

Depth : 20mm - 40mm

Neon letters 霓虹管发光字



Neon letters
霓虹管发光字

The best size : 150mm - 400mm

Application : indoor / outdoor





Size : 50mm - 800mm

Depth : 25mm - 35mm

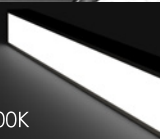
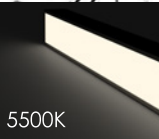
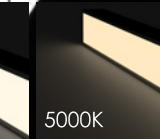
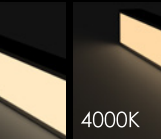
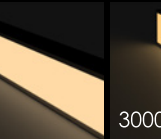
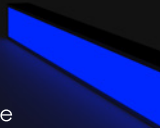
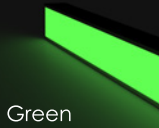

LED color (for LED signage series)

OSRAM  CREE  EPISTAR

 6500K	 5500K	 5000K	 4000K	 3000K
 Blue	 Green	 Yellow	 Red	 Full color

Full acrylic letters 全亚克力发光字



- ZERONE® Mini module
- ZERONE® Waterproof mini module
- Lamp LED
- LED strip
- Letter PCB LED



- ZERONE® Mini module
- ZERONE® Waterproof mini module
- Lamp LED
- LED strip
- Letter PCB LED

Channel letters 金属围边发光字



- ZERONE® Mini module
- ZERONE® Waterproof mini module
- Waterproof LED module
- LED strip
- Waterproof LED strip

LED bulb letters 外露灯发光字



- Lamp LED
- LED bulb
- LED exposed light
- LED pixel light

Diamond letters 钻石发光字



- ZERONE® Mini module
- ZERONE® Waterproof mini module
- LED strip
- Letter PCB LED

Neon letters 霓虹管发光字



- ZERONE® Mini module
- Lamp LED
- LED strip
- Letter PCB LED
- LED neon tube

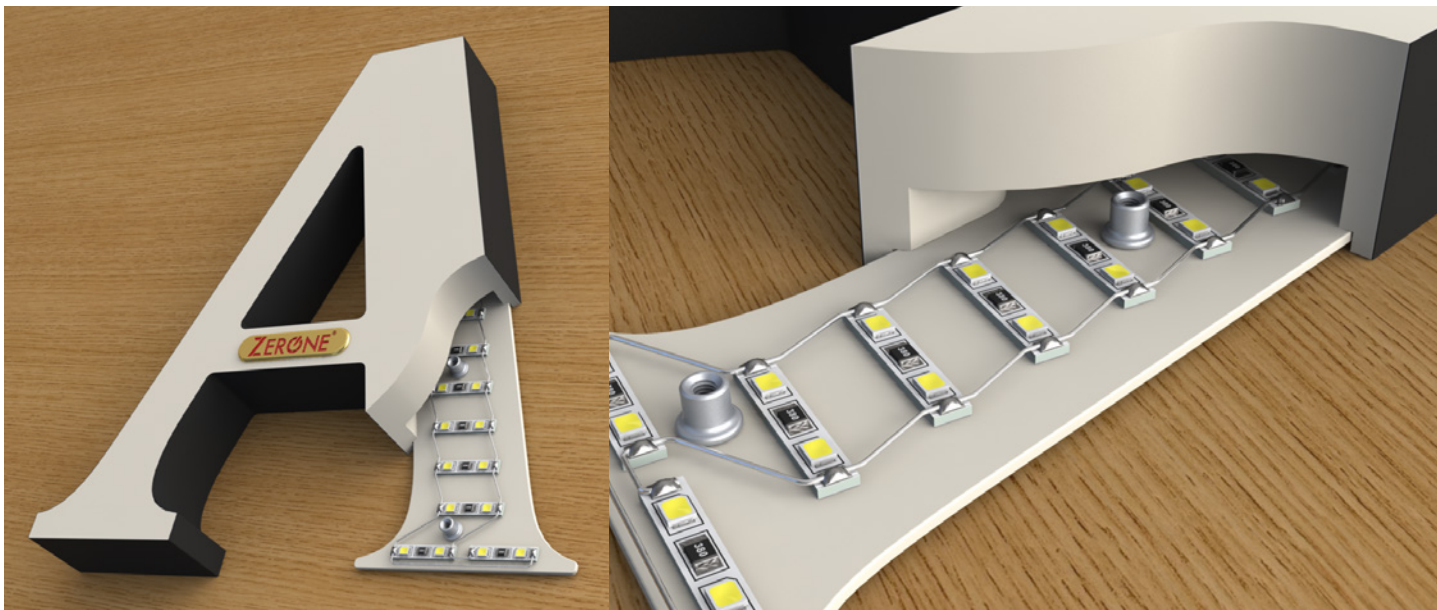

ZERONE® Mini module (1LED / 2LEDs / 3LEDs) 迷你模组

LED brand : OSRAM  CREE 

LED Module brand : ZERONE®

Warranty : 3 years for indoor / 2 years for outdoor

Waterproof level : IP65 for outdoor

Voltage : DC 12V Watt : 0.2W for 1 module

Application : Lumi letters (indoor & outdoor) / Mini letters (indoor & outdoor) / Channel letters (indoor)
/ Diamond letters (indoor)

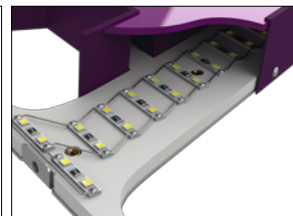

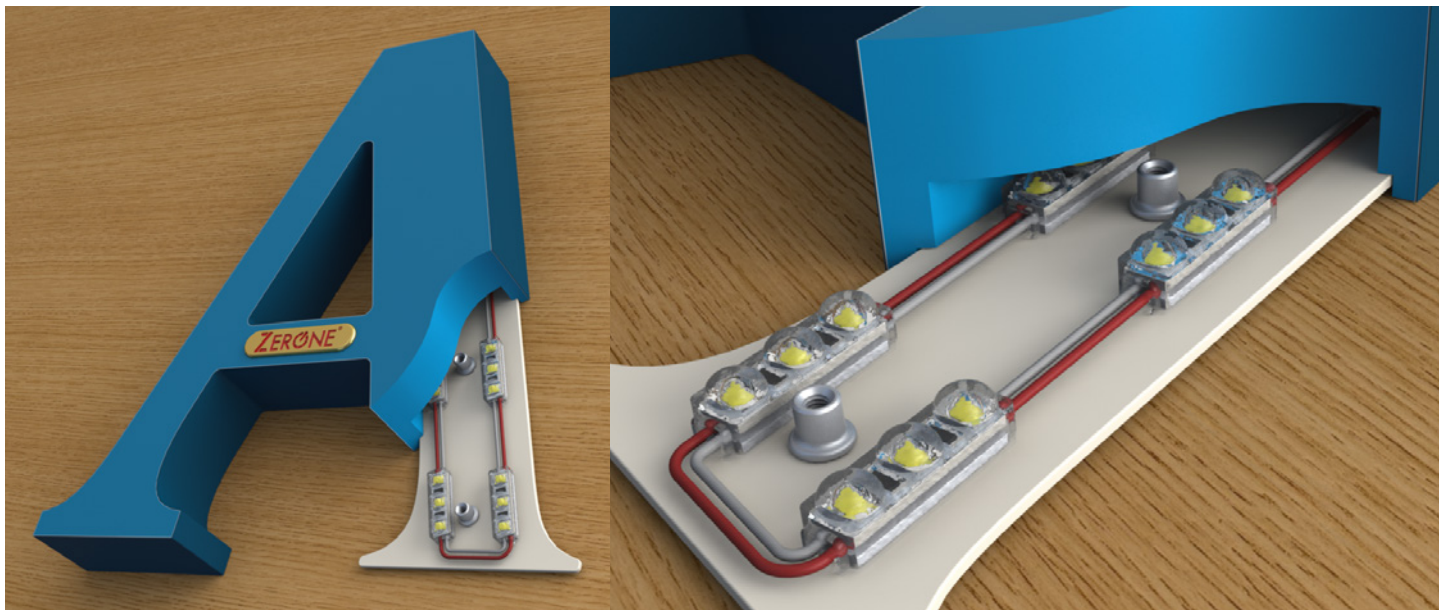

ZERONE® Waterproof mini module (3LEDs) 防水迷你模组

LED brand : **OSRAM**  **CREE** 

LED Module brand : **ZERONE**®

Warranty : 5 years

Waterproof level : IP67

Voltage : DC 12V Watt : 0.24W for 1 module

Application : Lumi letters / Mini letters / Channel letters / Diamond letters (all for outdoor)

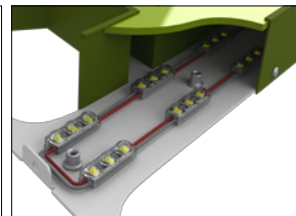

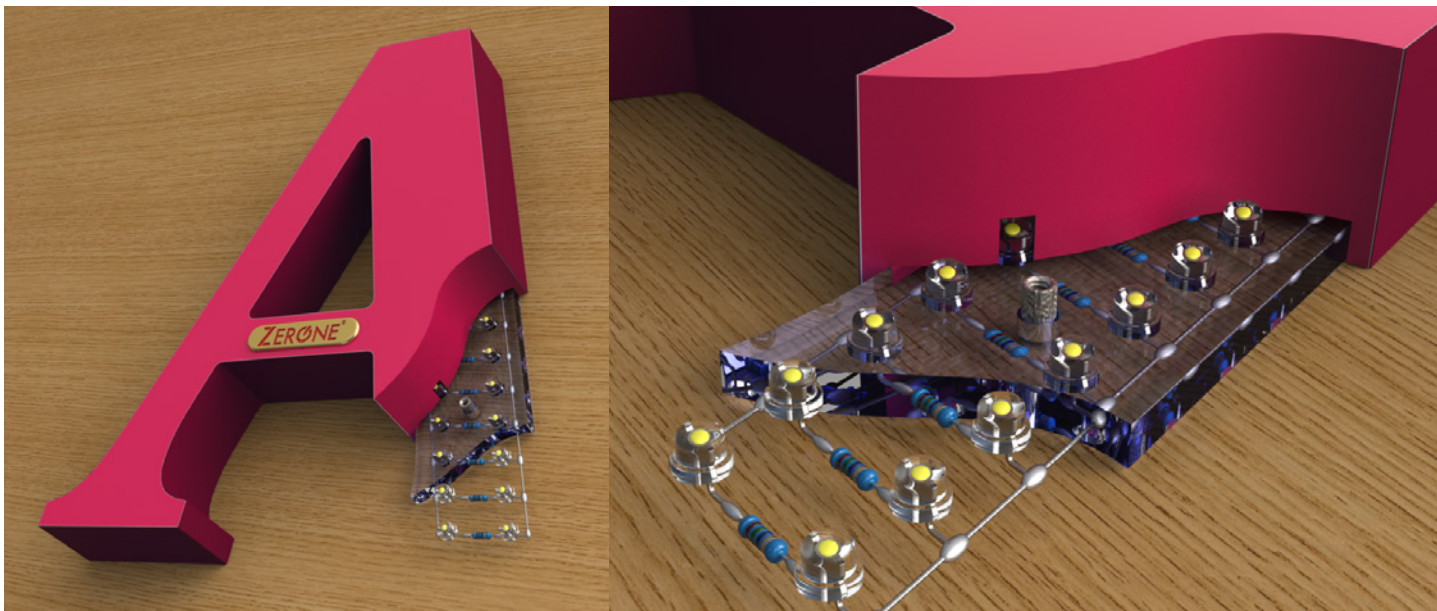

Lamp LED 5mm 草帽型灯珠

LED brand : **CREE** ⇄ EPISTAR

Warranty : 2 years

Waterproof level : IP68 for full acrylic letters

Voltage : DC 12V Watt : 0.07W for 1 LED

Application : Lumi letters (outdoor) / Mini letters (outdoor) LED bulb letters (indoor)

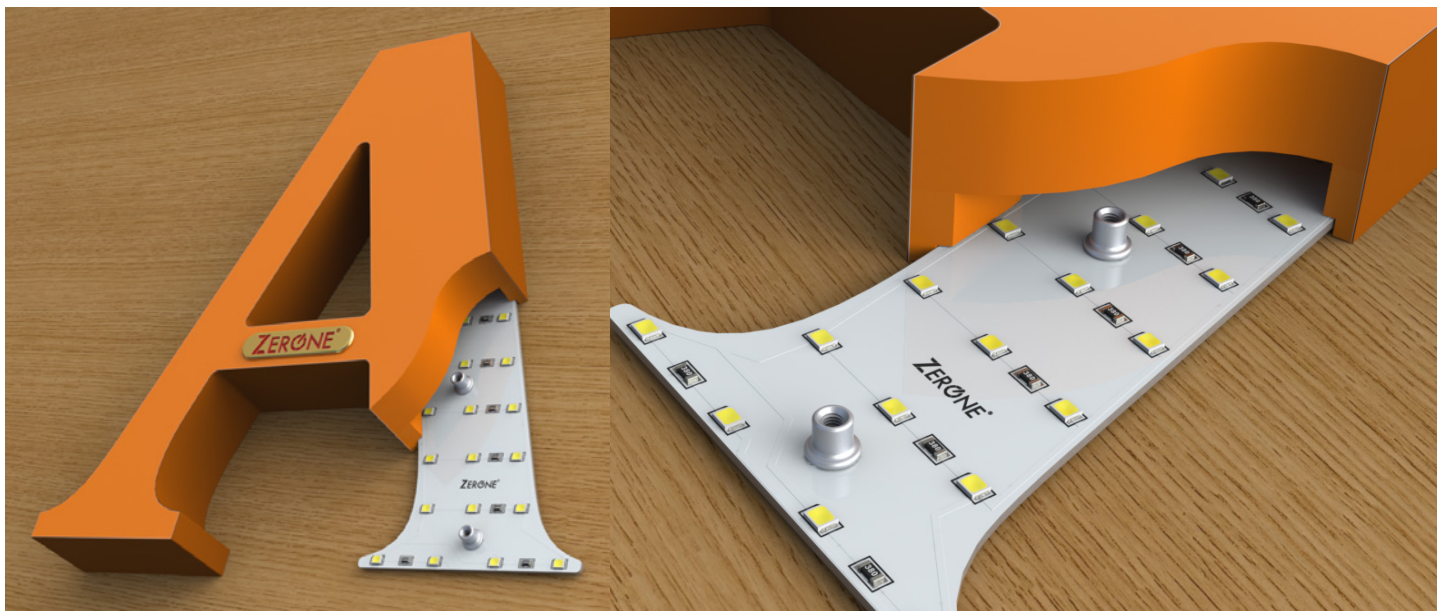

Letter PCB LED 字形灯板

LED brand : **OSRAM**  **CREE** 

Warranty : 2 years

Waterproof level : IP65 for outdoor

Voltage : DC 5V (for full color) Maximum Watt : 0.25W for 1 LED / DC 12V Watt : 0.07W for 1 LED

Application : Lumi letters (indoor & outdoor) / Mini letters (indoor & outdoor) / Channel letters (indoor)
/ Neon letters (indoor & outdoor) / Diamond letters (indoor & outdoor)

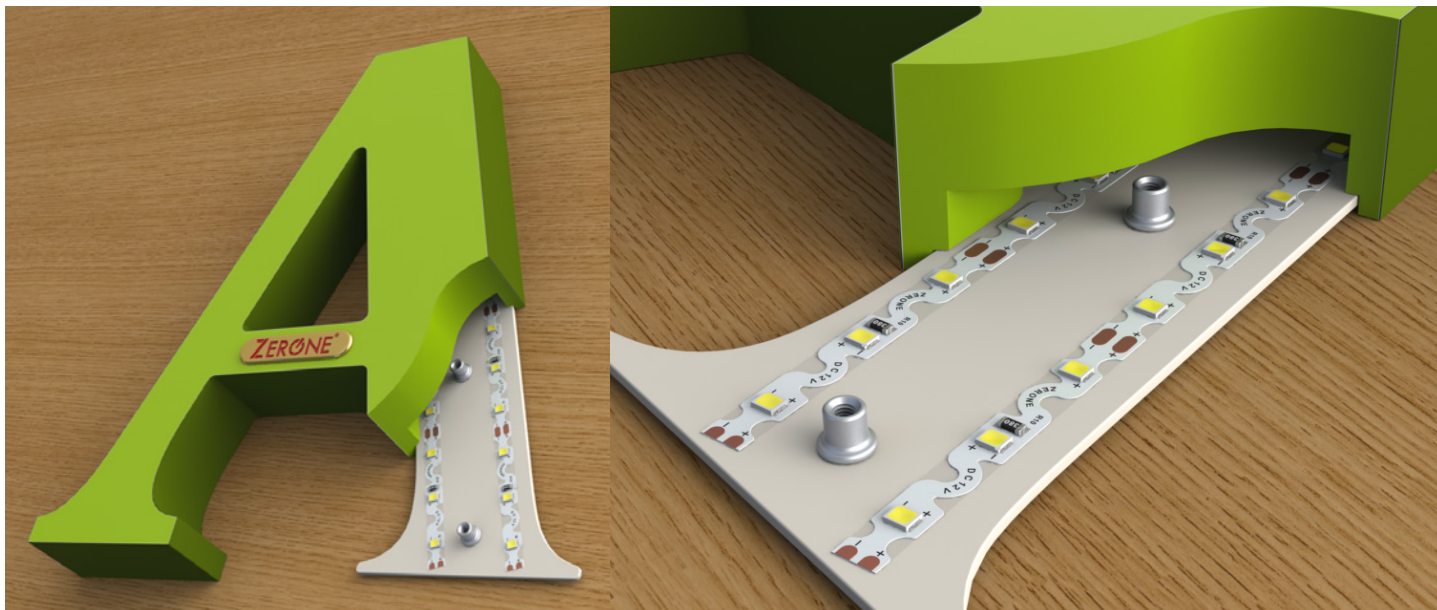

LED strip S 型灯带

Warranty : 1 year

Waterproof level : IP63 for outdoor

Voltage : DC 5V (for full color) / DC 12V

Application : Lumi letters (indoor & outdoor) / Mini letters (indoor & outdoor) / Channel letters (indoor)
/ Neon letters (indoor) / Diamond letters (indoor & outdoor)

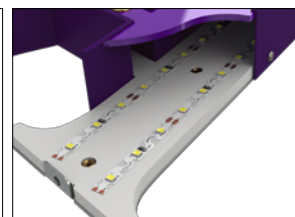



Waterproof LED strip 挤出型防水灯带

Warranty : 2 years for indoor / 1 year for outdoor

Waterproof level : IP65

Voltage : DC 5V (for full color) / DC 12V

Application : Channel letters



Waterproof LED module 防水模组

Warranty : 3 years / 5 years

Waterproof level : IP68

Voltage : DC 5V (for full color) / DC 12V

Application : Channel letters

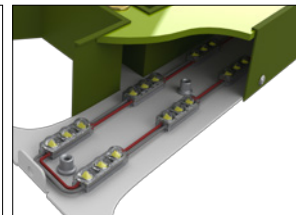
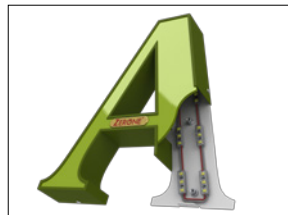



LED exposed light / LED bulb / LED pixel light

LED 外露灯 / LED 灯泡 / LED 像素灯

Warranty : 2 years for single color / 1 year for full color

Waterproof level : IP68

Voltage : DC 5V (for full color) / DC 12V

Application : LED bulb letters

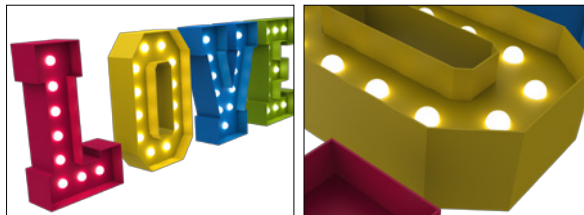



LED neon tube 柔性霓虹管

Warranty : 1 year

Waterproof level : IP67

Voltage : DC 5V (for full color) / DC 12V / DC 24V

Application : Neon letters



The LED signage series detailed classification >>
发光字产品详细分类

Please visit our website to download more detailed catalogue : www.zerone-sign.com
请登录零壹标识官方网站下载更详细的产品目录和规格资料

No.: A001 TYPE : Front lit 前面发光

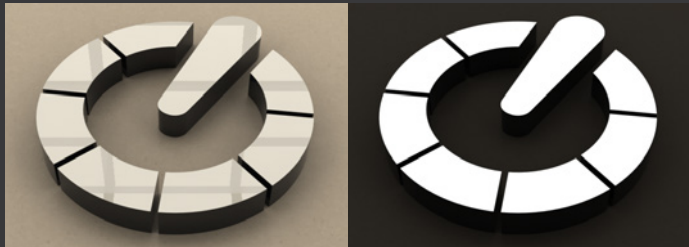

No.: A002 TYPE : Front & Back lit 前面 + 背面发光

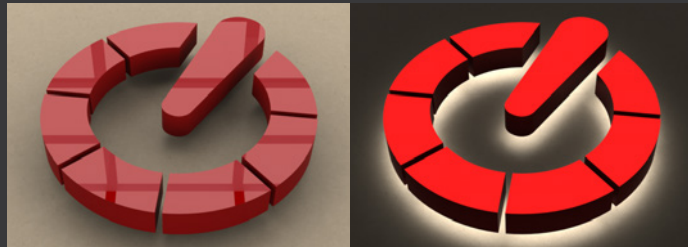

No.: A003 TYPE : Side lit 侧边发光

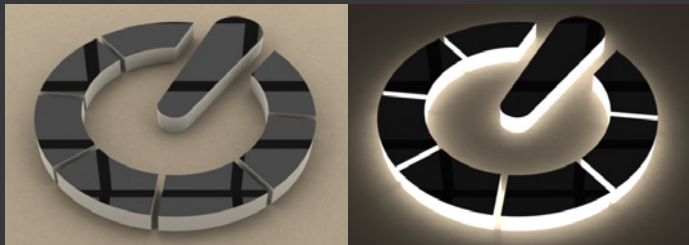

No.: A004 TYPE : Back lit 背面发光

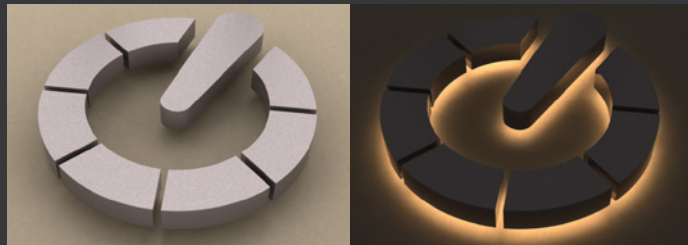

No.: A005 TYPE : Upside lit 上侧边发光

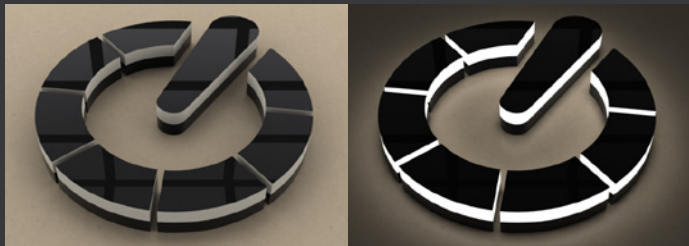

No.: A006 TYPE : Down side lit 下侧边发光

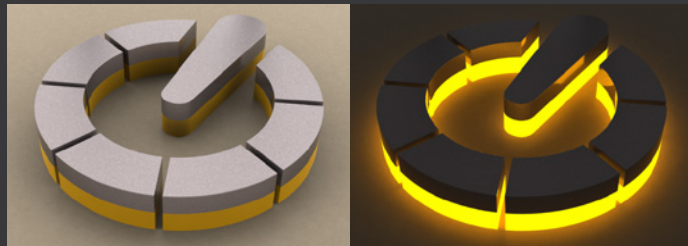

Lumi letters (Vertical side)

直边亚克力发光字

ZERONE®

No.: A007 TYPE : Front & Down side lit 前面 + 下侧边发光



No.: A008 TYPE : Front & Upside lit 上侧边 + 前面发光

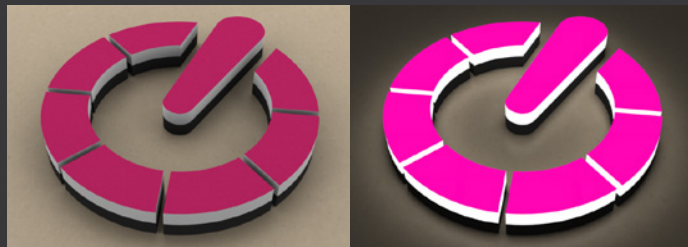

No.: A009 TYPE : Whole lit 前面 + 侧边发光



No.: A010 TYPE : Upside & Back lit 上侧边 + 背面发光

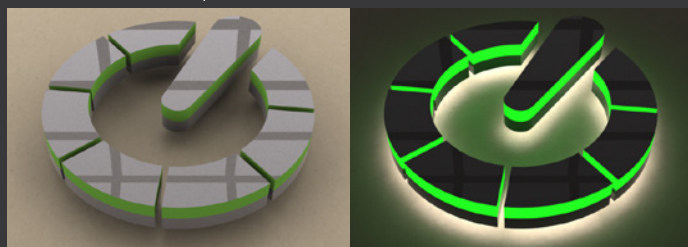

No.: A011 TYPE : Whole & Back lit 上侧边 + 前面 + 背面发光



No.: A012 TYPE : Down side & Back lit 下侧边 + 背面发光



Mini letters (Bevel side)

斜边迷你发光字

ZERONE®

No.: M001 TYPE : Front lit 前面发光



No.: M002 TYPE : Front & Down side lit 前面 + 下侧边发光



No.: M003 TYPE : Side lit 侧面发光

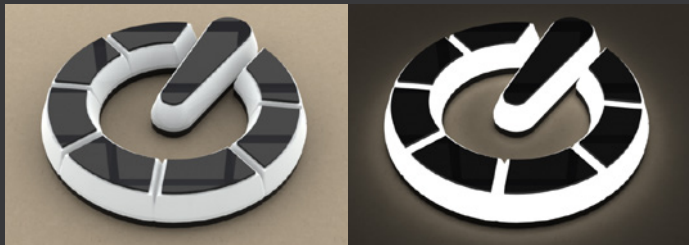

No.: M004 TYPE : Back lit 背面发光

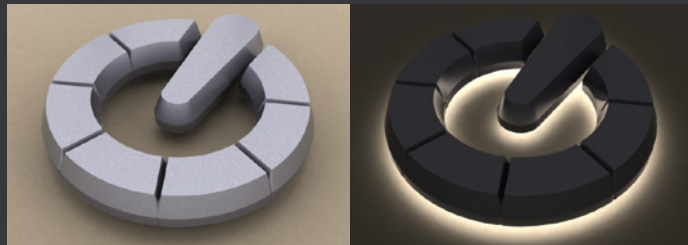

No.: M005 TYPE : Down side lit 下侧边发光



No.: M006 TYPE : Whole lit 前面 + 斜边发光



Channel letters 金属围边发光字

ZERONE®

No.: C001 TYPE : Front lit 前面发光



No.: C002 TYPE : Front & Back lit 前面 + 背面发光

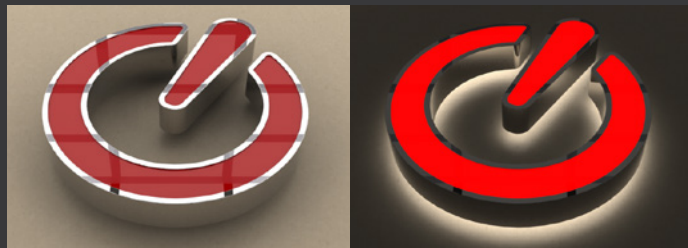

No.: C003 TYPE : Back lit 背面发光

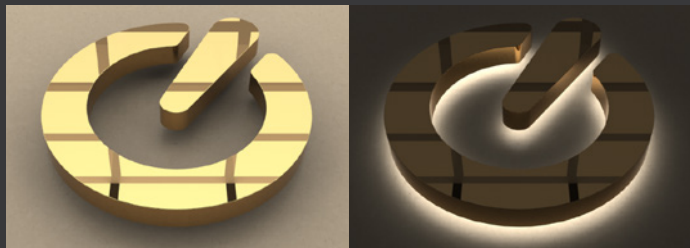

No.: C004 TYPE : Down side lit 下侧边发光

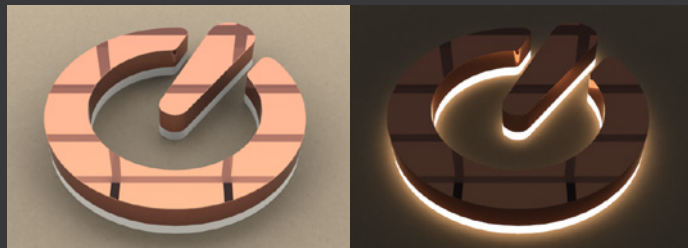

No.: C005 TYPE : All Front lit 无边字前面发光



No.: C006 TYPE : Front & Up side lit 上侧边 + 前面发光



A001

Lumi letters (Vertical side)
Front lit specification

直边亚克力发光字
前面发光 规格资料

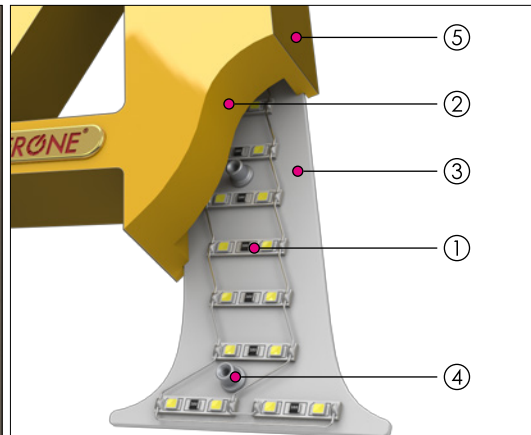

Specification 规格资料

Size 高度	60-800mm Recommended: 100-400mm 推荐高度 :100-400mm
Depth 厚度	18-35mm Recommended: 25mm-30mm 推荐厚度 :25mm-30mm
Minimum Stroke 最小笔划宽度	12mm Recommended: 15mm 推荐最小笔划宽度 :15mm

- ① LED.
- ② Acrylic. 亚克力 Thickness: 18-35mm Recommended: 25-30mm
- ③ FR-4 epoxy board. 环氧板 Thickness: 1.0mm / 1.2mm / 1.5mm
- ④ Nut fixed in the FR-4 epoxy board. M3 or M4. 螺母, M3 或 M4
- ⑤ Painted finish side and back. 侧面和背面喷涂油漆

LED Options.	Warranty.
1. ZERONE Mini module	indoor 3 years / outdoor 2 years
2. ZERONE Waterproof mini module	5 years
3. Lamp LED	2 years
4. LED strip	1 year
5. Letter PCB LED	2 years

M002

Mini letters (Bevel side)

Front & Down side lit specification

斜边迷你发光字

前面 + 下侧边发光 规格资料

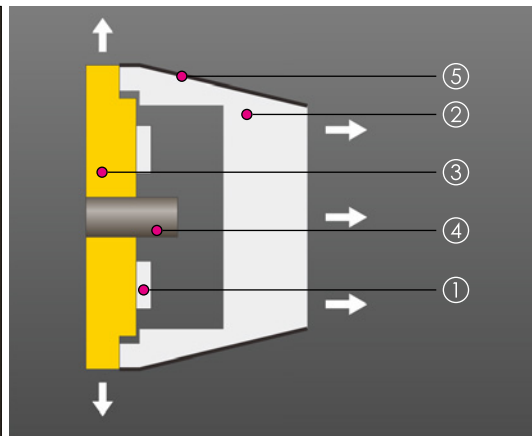

Specification 规格资料

Size 高度	20-800mm Recommended: 40-200mm 推荐高度 :40-200mm
Depth 厚度	22-35mm Recommended: 25mm-35mm 推荐厚度 :25mm-30mm
Minimum Stroke 最小笔划宽度	2mm Recommended: 6mm 推荐最小笔划宽度 :6mm

- ① LED.
- ② Acrylic. 亚克力 Thickness: 18-30mm Recommended: 20-30mm
- ③ Acrylic. 亚克力 Thickness: 4-8mm Recommended: 6mm
- ④ Nut fixed in the acrylic. 螺母 M3 or M4
- ⑤ Painted finish bevel side and back. 斜侧边和背面喷涂油漆

LED Options.	Warranty.
1. ZERONE Mini module	indoor 3 years / outdoor 2 years
2. ZERONE Waterproof mini module	5 years
3. Lamp LED	2 years
4. LED strip	1 year
5. Letter PCB LED	2 years

C001

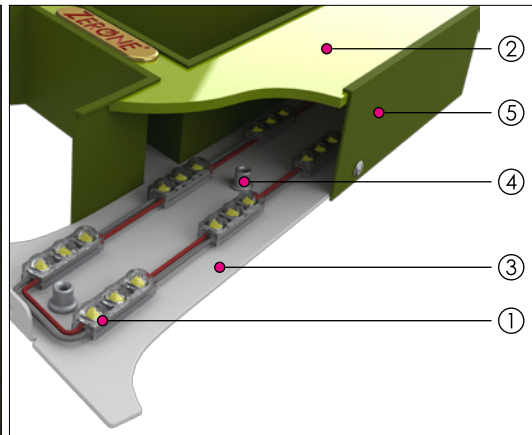
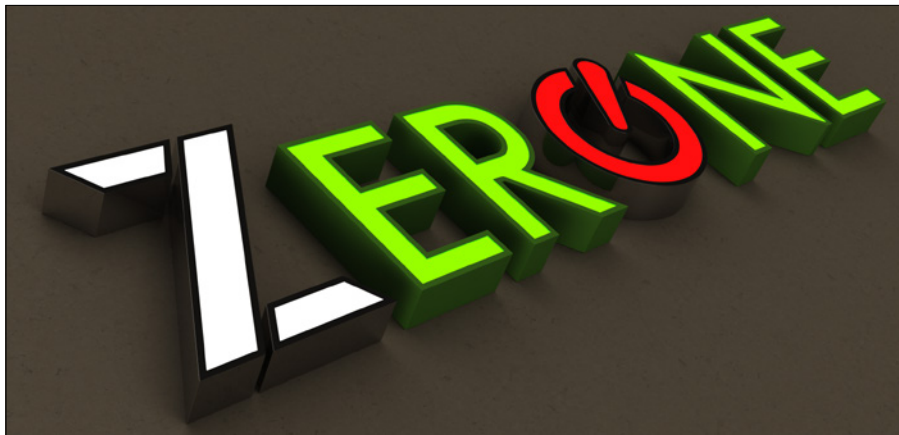
Channel letters
Front lit specification金属围边发光字
前面发光 规格资料

Specification 规格资料

Size 高度	100-2000mm Recommended: 150-1200mm 推荐高度 : 150-1200mm
Depth 厚度	30-120mm Recommended: 50mm-100mm 推荐厚度 : 50mm-100mm
Minimum Stroke 最小笔划宽度	18mm Recommended: 25mm 推荐最小笔划宽度 : 25mm

① LED.

② Acrylic. 亚克力 Thickness: 3-8mm Recommended: 5mm

③ Stainless steel backplane. 不锈钢背板 Depth: 1.0mm

④ Nut fixed in the stainless steel backplane. 螺母 M3 / M4 / M5 / M6

⑤ Stainless steel side. 不锈钢侧边, 拉丝 / 镜面 / 烤漆

LED Options.

1. ZERONE Mini module

2. ZERONE Waterproof mini module

3. Waterproof LED module

4. LED strip

5. Waterproof LED strip

Warranty.

indoor 3 years / outdoor 2 years

5 years

3 years / 5 years

1 year

2 years

B003

LED bulb letters
45mm LED bulb specification

外露灯发光字
45mm 直径灯泡 规格资料

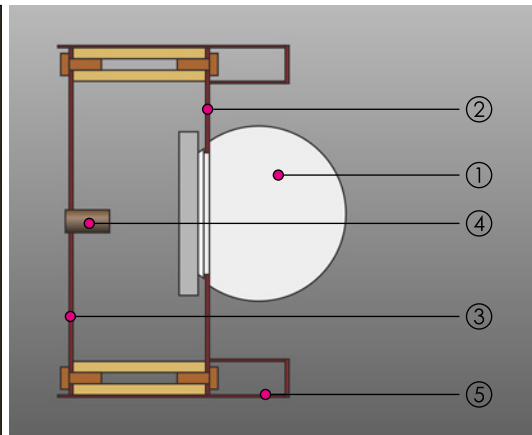

Specification 规格资料

Size 高度	300-2000mm Recommended: 400-1200mm 推荐高度 : 400-1200mm
Depth 厚度	50/60/80/100/120mm Recommended: 60/80mm 推荐厚度 : 60/80mm
Minimum Stroke 最小笔划宽度	65mm Recommended: 80mm 推荐最小笔划宽度 : 80mm

- ① LED bulb 45mm.
- ② Stainless steel. 不锈钢 Thickness: 0.8/1.0/1.2mm Recommended: 1.0mm
- ③ Stainless steel backplane. 不锈钢背板 Depth: 1.0mm
- ④ Nut fixed in the stainless steel backplane. 螺母 M3 / M4 / M5 / M6
- ⑤ Stainless steel side. 不锈钢侧边, 拉丝 / 镜面 / 烤漆

D001

Diamond letters

Front & Down side lit specification

钻石发光字

前面小孔透光 + 直侧边发光 规格资料

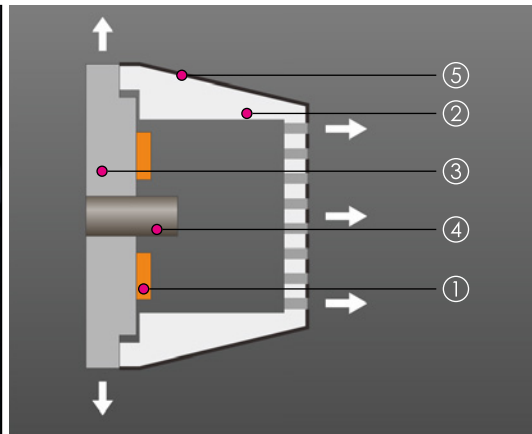
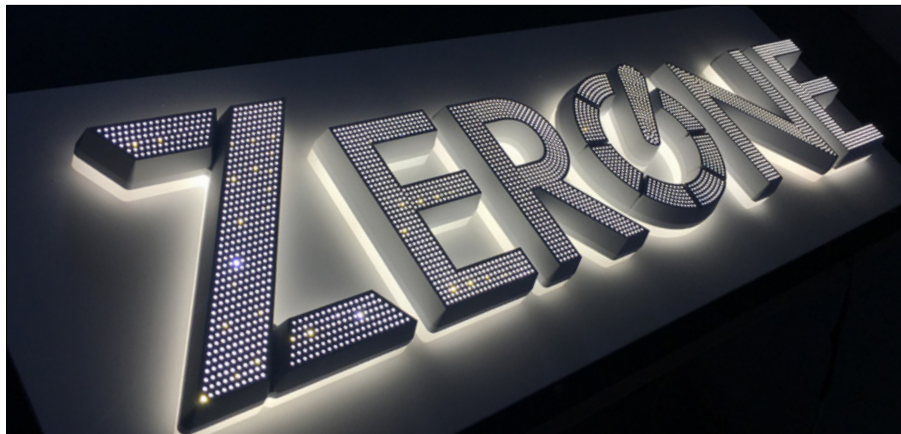

Specification 规格资料

Size 高度	50-1200mm Recommended: 100-400mm 推荐高度 : 100-400mm
Depth 厚度	22-36mm Recommended: 25mm 推荐厚度 : 25mm
Minimum Stroke 最小笔划宽度	10mm Recommended: 15mm 推荐最小笔划宽度 : 15mm

- ① LED.
- ② Acrylic. 亚克力 Thickness: 18-30mm Recommended: 20mm
- ③ Acrylic. 亚克力 Thickness: 4-10mm Recommended: 6mm
- ④ Nut fixed in the acrylic. 螺母 M3 or M4
- ⑤ Painted finish bevel side and front. 斜侧边和前面喷涂油漆

LED Options.	Warranty.
1. ZERONE Mini module	indoor 3 years / outdoor 2 years
2. ZERONE Waterproof mini module	5 years
3. LED strip	1 year
4. Letter PCB LED	2 years

N001

Neon letters

Acrylic neon - O type lit specification

霓虹管发光字

亚克力霓虹管 - O型面发光 规格资料

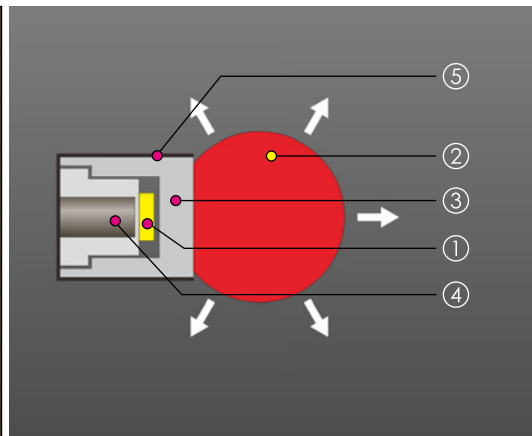
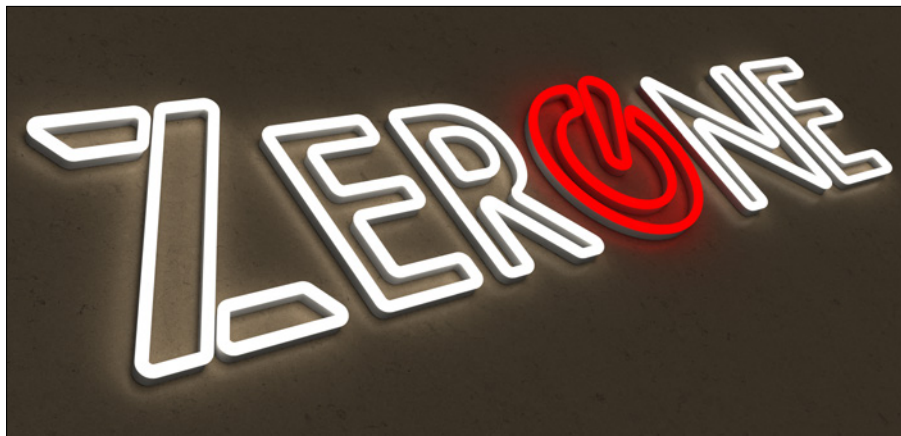

Specification 规格资料

Size 高度	80-1200mm Recommended: 100-400mm 推荐高度 : 100-400mm
Depth 厚度	30-40mm Recommended: 30-35mm 推荐厚度 : 30-35mm
Minimum Stroke 最小笔划宽度	12mm Recommended: 16mm 推荐笔划宽度 : 16mm

- ① LED.
- ② Acrylic. 亚克力 Thickness: 12-18mm Recommended: 15mm
- ③ Acrylic. 亚克力 Thickness: 15-25mm Recommended: 15-18mm
- ④ Nut fixed in the acrylic. 螺母 M3 or M4
- ⑤ Painted finish down side and back. 下侧边和背面喷涂油漆

LED Options.	Warranty.
1. ZERONE Mini module	indoor 3 years
2. Lamp LED	2 years
3. LED strip	indoor 1 year
4. Letter PCB LED	indoor 3 years / outdoor 2 years

Pictures show

零壹标识图片展示

ZERONE®

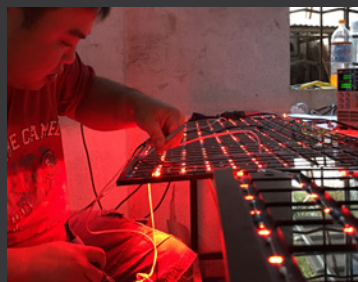

零壹标识公众号

WeChat Official Accounts



关注公众号，随时下载更新版本产品图册

WeChat scan qr code, download the new catalog

恩平市零壹光电标识有限公司

ENPING ZERO ONE SIGNAGE CO.,LTD

WWW.ZERONESIGN.COM

info@zerone-sign.com