



Prices effective July 5, 2023

Published March 2024

Everywhere™ Tables

HermanMiller list prices shown are in USD. For HermanMiller Canadian prices, multiply the USD list price by a factor of 1.20---effective July 2023.

Introduction	page 2
Everywhere™ Tables	3
Standard-Height Tables	5
Standard-Height Table Legs and Bases	74
Standing-Height Tables	78
Occasional Tables	84
Screens	90
Power and Data Support	109
Accessories	127
Indices	159
By Name	159
By Number	161
Appendices	
20-Day or Less/Assigned Lead-Time Order Information	
Vary Easy Program	
Stain-to-Match Program	
For the latest materials information, refer to the Materials pages on HermanMiller.com.	

Introduction

A Note on the Organization of This Book

There are a few signals that will help you understand the organization of this book. Once you know them, you should be able to find your way around easily.

Like a newspaper, this book is formatted with columns of text and illustrations that run vertically.

Information wraps from one column to the next and continues for as many pages as it needs to.

Black bars are clues.

A black bar at the top of a page signals the start of information about a product.

This information is divided into two sections, each signaled by a black bar. Product Information includes a description, additional notes, and dimensional drawings. Specification Information, which always begins at the top of a column, includes a series of steps. Each step represents a decision you need to make in order to complete your product number. Steps must be followed sequentially. The number of pages needed to complete information on a product varies; some will be complete in one page; others may fill three or four pages. Just continue going through the steps until you run into the next product, signaled by the black bar at the top of the page.

Black tabs running along the outside edge of the page help you locate what section you are in or what section you want to go to. You can thumb forwards or backwards to find a section; tabs and text appear on both sides of the page.

The additional pages in the back of the book include the appendices and indices. They are signaled by a long black bar running along the outside edge of the page.

The index is presented two ways.

The first index is in alphabetical order by product name. It can be helpful if you are new to the products and numbering scheme or if you are looking for a type of product, such as work chair or round table.

The second index is by product number. It lists, in alphanumeric order, the base product number, typically a five-digit number.

General Information

This book is effective July 5, 2023, subject to change without notice. Products may be purchased from authorized Herman Miller dealers who will quote prices upon request. For more information about our products and services or to see a list of dealers, visit www.HermanMiller.com.

All prices are list prices. Additional services, such as planning services, design, storage, and installation, are not included and must be added to these prices when the additional services are requested.

Illustrations, specifications, and prices are based on the latest information at the time of publication. The right is reserved to make changes at any time without notice in prices, fabrics, finishes, materials, specifications, and models, and also to discontinue models and finishes.

Dimensions shown in the drawings are engineering drawing dimensions rounded up to the nearest $\frac{1}{8}$ ". Product is shipped set up or knocked down. Products that include "Shipped knocked down" in the description require some assembly. If this statement does not appear in the description, the product is shipped assembled.

Service problems are normally handled by a Herman Miller authorized dealer. Where this cannot be accomplished on a local level, service problems should be referred to the Customer Care Representative for your region, Herman Miller, Inc., Zeeland, Michigan 49464.

20-Day or Less/Assigned Lead-Time Shipments

All products and options in this price book not designated by an Assigned Program icon  will ship in **20 business days or less** after being acknowledged by Herman Miller.

Products and options designated by an  are on the assigned lead-time program and may ship in 20 days, less than 20 days, or more than 20 days from order acknowledgement.

Standard-Height Tables

Standard-Height Table Legs and Bases

Standing-Height Tables

Occasional Tables

Screens

Power and Data Support

Accessories



Rectangular Table

DT1AE.
DT1AS.
DT1AT.

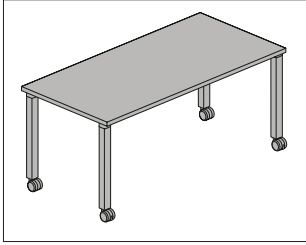

Product Information

Description

This rectangular table comes in multiple edge styles and has a laminate top with thermoplastic edge, laminate top with a thermoplastic backed plywood edge, veneer top and edge, or painted top and edge. It has multiple leg options, and is available with casters or glides. The caster option has 2 locking and 2 non-locking casters. Glides have 1/2" leveling range. Shipped knocked down. Height-adjustable legs have a 5" range in 1" increments.

Notes

- 18" depth available with square edge only.
- C-leg and D-leg cannot be used with either the 18" deep or 36" deep tops.
- When specifying grommets (253, 254, 255), cutouts will be located in the center of table.
- Cutouts available for all Connect™ power and data accessories (see Thrive™ Portfolio). Cutouts will be located in the center at approximately 3" from the rear edge of surface.
- Reinforcement channels are used under table tops 54" and wider. They will be located along the center line for 18" deep and 24" deep surfaces, and 19" from the front edge for 30" deep surfaces.
- For additional details on available edge options see Appendices.
- For additional size, edge, finish, and cable management options, see Vary Easy Program in Appendices.
- Note: UL listed when used with Connect single circuit electrical product (Y137x.) with post leg (P), T-leg (T) and C-leg (C) options.
- MicrobeCare™ is an antimicrobial coating applied to the laminate or veneer surface of this product.
- MicrobeCare™ protects products from mold, mildew, algae, and bacteria that cause deterioration, discoloration, odors, and stains. MicrobeCare™ is registered with the US Environmental Protection Agency (EPA).

Dimensions

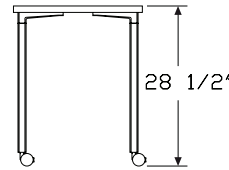
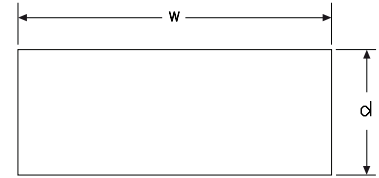

P

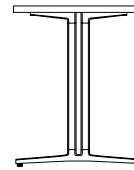

T

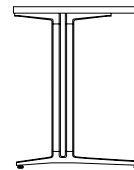

C

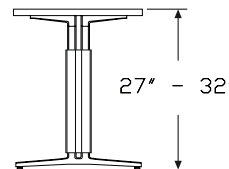

A

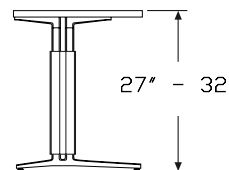

D



Everywhere™ Standard-Height Tables

Rectangular Table *continued*

Specification Information

Step 1.

DT1A

Step 2. Edge

- S.** squared-edge
- T.** thin-edge
- E.** eased-edge

Step 3. Depth

For squared-edge (S.)

- 18** 18" deep
- 24** 24" deep
- 30** 30" deep
- 36** 36" deep

For thin-edge (T.) or eased-edge (E.)

- 24** 24" deep
- 30** 30" deep
- 36** 36" deep

Step 4. Width

For 18" deep (18)

- 48** 48" wide
- 60** 60" wide
- 72** 72" wide

For 24" deep (24) or 30" deep (30)

- 36** 36" wide
- 42** 42" wide
- 48** 48" wide
- 54** 54" wide
- 60** 60" wide
- 66** 66" wide
- 72** 72" wide

For 36" deep (36)

- 42** 42" wide
- 48** 48" wide
- 54** 54" wide
- 60** 60" wide
- 66** 66" wide
- 72** 72" wide

Step 5. Surface Material

For squared-edge (S.)

- L** high-pressure laminate top/thermoplastic edge
- M** thermally-fused laminate top/thermoplastic edge
- U** high-pressure laminate/universal edge
- T** thermally-fused laminate top/universal edge
- W** veneer top/veneer edge A
- P** painted Formcoat® top/edge
- A** high-pressure laminate top/thermoplastic edge with MicrobeCare™ A
- J** thermally-fused laminate top/thermoplastic edge with MicrobeCare™ A
- B** veneer top/veneer edge with MicrobeCare™ A
- C** high-pressure laminate top/universal edge with MicrobeCare™ A
- K** thermally-fused laminate top/universal edge with MicrobeCare™ A

For thin-edge (T.)

- W** veneer top/veneer edge A
- P** painted Formcoat® top/edge
- B** veneer top/veneer edge with MicrobeCare™ A

For eased-edge (E.)

- P** painted Formcoat® top/edge

Step 6. Leg Type

For 18" deep (18) or 36" deep (36)

- P** post leg
- T** T-leg
- A** T-leg with height adjustment

For 24" deep (24) or 30" deep (30)

- P** post leg
- T** T-leg
- A** T-leg with height adjustment
- C** C-leg
- D** C-leg with height adjustment

Prices for Steps 1-6.

	LP	LT	LA	LC	LD	MP
DT1AS. 18 48	\$1071	1386	1735	—	—	1001
60	\$1175	1525	1906	—	—	1098
72	\$1269	1646	2058	—	—	1186

Rectangular Table *continued*

24 36	\$1071	1386	1735	1386	1735	1001
42	\$1125	1459	1821	1459	1821	1051
48	\$1176	1527	1910	1527	1910	1099
54	\$1249	1623	2023	1623	2023	1167
60	\$1323	1717	2144	1717	2144	1236
66	\$1415	1839	2296	1839	2296	1322
72	\$1517	1969	2456	1969	2456	1418
30 36	\$1112	1443	1801	1443	1801	1039
42	\$1166	1517	1896	1517	1896	1090
48	\$1227	1592	1984	1592	1984	1147
54	\$1298	1685	2106	1685	2106	1213
60	\$1377	1787	2232	1787	2232	1287
66	\$1473	1910	2387	1910	2387	1376
72	\$1575	2043	2555	2043	2555	1472
36 42	\$1274	1638	2061	—	—	1190
48	\$1292	1625	2076	—	—	1207
54	\$1411	1750	2197	—	—	1318
60	\$1436	1772	2215	—	—	1342
66	\$1515	1939	2441	—	—	1415
72	\$1612	2063	2594	—	—	1507
	MT	MA	MC	MD	UP	UT
DT1AS. 18 48	\$1295	1622	—	—	1071	1386
60	\$1425	1781	—	—	1175	1525
72	\$1539	1924	—	—	1269	1646
24 36	\$1295	1622	1295	1622	1071	1386
42	\$1363	1701	1363	1701	1125	1459
48	\$1427	1785	1427	1785	1176	1527
54	\$1516	1890	1516	1890	1249	1623
60	\$1605	2003	1605	2003	1323	1717
66	\$1718	2146	1718	2146	1415	1839
72	\$1840	2295	1840	2295	1517	1969
30 36	\$1348	1682	1348	1682	1112	1443
42	\$1418	1772	1418	1772	1166	1517
48	\$1488	1855	1488	1855	1227	1592
54	\$1575	1968	1575	1968	1298	1685
60	\$1670	2085	1670	2085	1377	1787
66	\$1785	2231	1785	2231	1473	1910
72	\$1909	2388	1909	2388	1575	2043
36 42	\$1530	1926	—	—	1274	1638
48	\$1519	1941	—	—	1292	1625
54	\$1636	2053	—	—	1411	1750
60	\$1656	2070	—	—	1436	1772
66	\$1812	2281	—	—	1515	1939
72	\$1928	2424	—	—	1612	2063

	UA	UC	UD	TP	TT	TA
DT1AS. 18 48	\$1735	—	—	1001	1295	1622
60	\$1906	—	—	1098	1425	1781
72	\$2058	—	—	1186	1539	1924
24 36	\$1735	1386	1735	1001	1295	1622
42	\$1821	1459	1821	1051	1363	1701
48	\$1910	1527	1910	1099	1427	1785
54	\$2023	1623	2023	1167	1516	1890
60	\$2144	1717	2144	1236	1605	2003
66	\$2296	1839	2296	1322	1718	2146
72	\$2456	1969	2456	1418	1840	2295
30 36	\$1801	1443	1801	1039	1348	1682
42	\$1896	1517	1896	1090	1418	1772
48	\$1984	1592	1984	1147	1488	1855
54	\$2106	1685	2106	1213	1575	1968
60	\$2232	1787	2232	1287	1670	2085
66	\$2387	1910	2387	1376	1785	2231
72	\$2555	2043	2555	1472	1909	2388
36 42	\$2061	—	—	1190	1530	1926
48	\$2076	—	—	1207	1519	1941
54	\$2197	—	—	1318	1636	2053
60	\$2215	—	—	1342	1656	2070
66	\$2441	—	—	1415	1812	2281
72	\$2594	—	—	1507	1928	2424
	TC	TD	WP	WT	WA	WC
DT1AS. 18 48	—	—	\$1231	1624	2048	—
60	—	—	\$1364	1796	2260	—
72	—	—	\$1480	1945	2449	—
24 36	\$1295	1622	1231	1624	2048	1624
42	\$1363	1701	1298	1710	2155	1710
48	\$1427	1785	1367	1798	2267	1798
54	\$1516	1890	1452	1909	2409	1909
60	\$1605	2003	1545	2028	2557	2028
66	\$1718	2146	1658	2176	2739	2176
72	\$1840	2295	1778	2334	2936	2334
30 36	\$1348	1682	1285	1692	2134	1692
42	\$1418	1772	1350	1779	2243	1779
48	\$1488	1855	1426	1874	2360	1874
54	\$1575	1968	1512	1991	2505	1991
60	\$1670	2085	1609	2114	2661	2114
66	\$1785	2231	1726	2267	2855	2267
72	\$1909	2388	1857	2427	3058	2427

Everywhere™ Standard-Height Tables

Rectangular Table *continued*

Everywhere™ Standard-Height Tables

36 42	—	—	\$1726	2077	2442	—
48	—	—	\$1771	2109	2483	—
54	—	—	\$1913	2259	2627	—
60	—	—	\$1976	2324	2727	—
66	—	—	\$2240	2785	3180	—
72	—	—	\$2347	3088	3567	—
	WD	PP	PT	PA	PC	PD
DT1AS. 18 48	—	\$1165	1509	1887	—	—
60	—	\$1282	1662	2075	—	—
72	—	\$1382	1794	2235	—	—
24 36	\$2048	1165	1509	1887	1509	1887
42	\$2155	1222	1587	1977	1587	1977
48	\$2267	1283	1665	2079	1665	2079
54	\$2409	1357	1763	2204	1763	2204
60	\$2557	1440	1870	2332	1870	2332
66	\$2739	1539	2001	2497	2001	2497
72	\$2936	1649	2137	2670	2137	2670
30 36	\$2134	1207	1569	1962	1569	1962
42	\$2243	1272	1649	2062	1649	2062
48	\$2360	1335	1731	2161	1731	2161
54	\$2505	1409	1831	2289	1831	2289
60	\$2661	1498	1945	2426	1945	2426
66	\$2855	1601	2079	2596	2079	2596
72	\$3058	1713	2222	2778	2222	2778
36 42	—	\$1385	1780	2236	—	—
48	—	\$1405	1767	2260	—	—
54	—	\$1534	1903	2387	—	—
60	—	\$1562	1927	2411	—	—
66	—	\$1587	2075	2628	—	—
72	—	\$1607	2240	2817	—	—
	AP	AT	AA	AC	AD	JP
DT1AS. 18 48	\$1173	1489	1838	—	—	1095
60	\$1277	1627	2009	—	—	1193
72	\$1372	1748	2160	—	—	1283
24 36	\$1160	1475	1823	1475	1823	1084
42	\$1214	1548	1909	1548	1909	1134
48	\$1279	1631	2013	1631	2013	1195
54	\$1351	1726	2124	1726	2124	1262
60	\$1425	1820	2247	1820	2247	1331
66	\$1518	1940	2399	1940	2399	1419
72	\$1620	2071	2557	2071	2557	1513

30 36	\$1200	1531	1890	1531	1890	1121
42	\$1255	1606	1983	1606	1983	1173
48	\$1330	1694	2088	1694	2088	1243
54	\$1402	1788	2209	1788	2209	1310
60	\$1480	1890	2333	1890	2333	1384
66	\$1575	2013	2489	2013	2489	1472
72	\$1678	2145	2658	2145	2658	1567
36 42	\$1361	1728	2148	—	—	1272
48	\$1394	1730	2180	—	—	1302
54	\$1513	1852	2299	—	—	1413
60	\$1538	1875	2319	—	—	1438
66	\$1619	2043	2544	—	—	1512
72	\$1715	2165	2697	—	—	1603
	JT	JA	JC	JD	BP	BT
DT1AS. 18 48	\$1391	1717	—	—	1330	1721
60	\$1521	1877	—	—	1461	1893
72	\$1633	2018	—	—	1577	2041
24 36	\$1378	1704	1378	1704	1316	1708
42	\$1446	1784	1446	1784	1381	1794
48	\$1525	1881	1525	1881	1464	1896
54	\$1612	1985	1612	1985	1548	2007
60	\$1700	2099	1700	2099	1641	2125
66	\$1813	2241	1813	2241	1754	2272
72	\$1935	2390	1935	2390	1875	2430
30 36	\$1430	1766	1430	1766	1369	1776
42	\$1501	1853	1501	1853	1435	1863
48	\$1582	1951	1582	1951	1522	1971
54	\$1671	2064	1671	2064	1609	2088
60	\$1766	2181	1766	2181	1705	2211
66	\$1881	2325	1881	2325	1823	2363
72	\$2004	2484	2004	2484	1953	2525
36 42	\$1614	2008	—	—	1809	2161
48	\$1616	2037	—	—	1867	2206
54	\$1731	2149	—	—	2009	2356
60	\$1751	2167	—	—	2074	2420
66	\$1909	2378	—	—	2336	2882
72	\$2024	2520	—	—	2444	3184
	BA	BC	BD	CP	CT	CA
DT1AS. 18 48	\$2145	—	—	1173	1489	1838
60	\$2358	—	—	1277	1627	2009
72	\$2547	—	—	1372	1748	2160

Rectangular Table *continued*

24 36	\$2133	1708	2133	1160	1475	1823
42	\$2240	1794	2240	1214	1548	1909
48	\$2363	1896	2363	1279	1631	2013
54	\$2504	2007	2504	1351	1726	2124
60	\$2655	2125	2655	1425	1820	2247
66	\$2837	2272	2837	1518	1940	2399
72	\$3034	2430	3034	1620	2071	2557
30 36	\$2217	1776	2217	1200	1531	1890
42	\$2327	1863	2327	1255	1606	1983
48	\$2456	1971	2456	1330	1694	2088
54	\$2602	2088	2602	1402	1788	2209
60	\$2758	2211	2758	1480	1890	2333
66	\$2952	2363	2952	1575	2013	2489
72	\$3154	2525	3154	1678	2145	2658
36 42	\$2525	—	—	1361	1728	2148
48	\$2580	—	—	1394	1730	2180
54	\$2725	—	—	1513	1852	2299
60	\$2824	—	—	1538	1875	2319
66	\$3277	—	—	1619	2043	2544
72	\$3665	—	—	1715	2165	2697
	CC	CD	KP	KT	KA	KC
DT1AS. 18 48	—	—	\$1095	1391	1717	—
60	—	—	\$1193	1521	1877	—
72	—	—	\$1283	1633	2018	—
24 36	\$1475	1823	1084	1378	1704	1378
42	\$1548	1909	1134	1446	1784	1446
48	\$1631	2013	1195	1525	1881	1525
54	\$1726	2124	1262	1612	1985	1612
60	\$1820	2247	1331	1700	2099	1700
66	\$1940	2399	1419	1813	2241	1813
72	\$2071	2557	1513	1935	2390	1935
30 36	\$1531	1890	1121	1430	1766	1430
42	\$1606	1983	1173	1501	1853	1501
48	\$1694	2088	1243	1582	1951	1582
54	\$1788	2209	1310	1671	2064	1671
60	\$1890	2333	1384	1766	2181	1766
66	\$2013	2489	1472	1881	2325	1881
72	\$2145	2658	1567	2004	2484	2004
36 42	—	—	\$1272	1614	2008	—
48	—	—	\$1302	1616	2037	—
54	—	—	\$1413	1731	2149	—
60	—	—	\$1438	1751	2167	—
66	—	—	\$1512	1909	2378	—
72	—	—	\$1603	2024	2520	—

							KD
DT1AS. 24 36							\$1704
42							\$1784
48							\$1881
54							\$1985
60							\$2099
66							\$2241
72							\$2390
30 36							\$1766
42							\$1853
48							\$1951
54							\$2064
60							\$2181
66							\$2325
72							\$2484
		TC	TD	WP	WT	WA	WC
DT1AT. 24 36		—	—	\$1480	1953	2457	1953
42		—	—	\$1555	2051	2585	2051
48		—	—	\$1641	2160	2718	2160
54		—	—	\$1744	2293	2887	2293
60		—	—	\$1854	2431	3066	2431
66		—	—	\$1988	2610	3287	2610
72		—	—	\$2133	2801	3523	2801
30 36		—	—	\$1539	2029	2561	2029
42		—	—	\$1620	2134	2693	2134
48		—	—	\$1710	2247	2828	2247
54		—	—	\$1815	2386	3007	2386
60		—	—	\$1929	2536	3192	2536
66		—	—	\$2074	2718	3423	2718
72		—	—	\$2222	2914	3668	2914
36 42		—	—	\$2074	2490	2930	—
48		—	—	\$2125	2529	2982	—
54		—	—	\$2299	2708	3151	—
60		—	—	\$2373	2789	3274	—
66		—	—	\$2687	3336	3815	—
72		—	—	\$2811	3705	4278	—
		WD	PP	PT	PA	PC	PD
DT1AT. 24 36		\$2457	1239	1609	2009	1609	2009
42		\$2585	1301	1688	2107	1688	2107
48		\$2718	1364	1771	2214	1771	2214
54		\$2887	1443	1876	2347	1876	2347
60		\$3066	1535	1992	2483	1992	2483
66		\$3287	1641	2129	2660	2129	2660
72		\$3523	1754	2276	2845	2276	2845

Everywhere™ Standard-Height Tables

Rectangular Table *continued*

Everywhere™ Standard-Height Tables

30 36	\$2561	1287	1672	2089	1672	2089
42	\$2693	1353	1754	2192	1754	2192
48	\$2828	1420	1842	2301	1842	2301
54	\$3007	1504	1956	2439	1956	2439
60	\$3192	1594	2072	2585	2072	2585
66	\$3423	1702	2214	2763	2214	2763
72	\$3668	1822	2368	2958	2368	2958
36 42	—	\$1475	1897	2385	—	—
48	—	\$1496	1881	2406	—	—
54	—	\$1632	2027	2543	—	—
60	—	\$1665	2056	2567	—	—
66	—	\$1724	2142	2862	—	—
72	—	\$1857	2401	3005	—	—

30 36	\$2645	2113	2645	—	—	—
42	\$2777	2217	2777	—	—	—
48	\$2927	2346	2927	—	—	—
54	\$3104	2482	3104	—	—	—
60	\$3289	2632	3289	—	—	—
66	\$3520	2814	3520	—	—	—
72	\$3764	3011	3764	—	—	—
36 42	\$3013	—	—	—	—	—
48	\$3081	—	—	—	—	—
54	\$3248	—	—	—	—	—
60	\$3371	—	—	—	—	—
66	\$3913	—	—	—	—	—
72	\$4376	—	—	—	—	—

	JT	JA	JC	JD	BP	BT
DT1AT. 24 36	—	—	—	—	\$1563	2038
42	—	—	—	—	\$1639	2135
48	—	—	—	—	\$1738	2257
54	—	—	—	—	\$1840	2390
60	—	—	—	—	\$1951	2529
66	—	—	—	—	\$2086	2707
72	—	—	—	—	\$2230	2899
30 36	—	—	—	—	\$1624	2113
42	—	—	—	—	\$1704	2217
48	—	—	—	—	\$1806	2346
54	—	—	—	—	\$1911	2482
60	—	—	—	—	\$2027	2632
66	—	—	—	—	\$2170	2814
72	—	—	—	—	\$2319	3011
36 42	—	—	—	—	\$2158	2574
48	—	—	—	—	\$2221	2626
54	—	—	—	—	\$2396	2806
60	—	—	—	—	\$2470	2886
66	—	—	—	—	\$2785	3433
72	—	—	—	—	\$2908	3802

	WD	PP	PT	PA	PC	PD
DT1AE. 24 36	—	\$1239	1609	2009	1609	2009
42	—	\$1301	1688	2107	1688	2107
48	—	\$1364	1771	2214	1771	2214
54	—	\$1443	1876	2347	1876	2347
60	—	\$1535	1992	2483	1992	2483
66	—	\$1641	2129	2660	2129	2660
72	—	\$1754	2276	2845	2276	2845
30 36	—	\$1287	1672	2089	1672	2089
42	—	\$1353	1754	2192	1754	2192
48	—	\$1420	1842	2301	1842	2301
54	—	\$1504	1956	2439	1956	2439
60	—	\$1594	2072	2585	2072	2585
66	—	\$1702	2214	2763	2214	2763
72	—	\$1822	2368	2958	2368	2958
36 42	—	\$1475	1897	2385	—	—
48	—	\$1496	1881	2406	—	—
54	—	\$1632	2027	2543	—	—
60	—	\$1665	2056	2567	—	—
66	—	\$1737	2259	2885	—	—
72	—	\$1863	2415	3005	—	—

	BA	BC	BD	CP	CT	CA
DT1AT. 24 36	\$2542	2038	2542	—	—	—
42	\$2670	2135	2670	—	—	—
48	\$2814	2257	2814	—	—	—
54	\$2985	2390	2985	—	—	—
60	\$3164	2529	3164	—	—	—
66	\$3382	2707	3382	—	—	—
72	\$3619	2899	3619	—	—	—

Rectangular Table *continued*

Step 7.

Top Finish
For high-pressure laminate top/thermoplastic edge (L), high-pressure laminate/universal edge (U), high-pressure laminate top/thermoplastic edge with MicrobeCare™ (A), or high-pressure laminate top/universal edge with MicrobeCare™ (C)

76	light brown walnut	+\$0
91	white	+\$0
98	studio white	+\$0
8Q	folkstone grey	+\$0
CL	cool grey neutral	+\$0
HF	inner tone light	+\$0
HM	natural maple	+\$0
HP	light anigre	+\$0
HX	aged cherry	+\$0
LBA	clear on ash	+\$0
LBR	phantom ecru	+\$0
LBS	phantom cocoa	+\$0
LBU	medium matte walnut	+\$0
LBV	warm grey teak	+\$0
LBB	oak on ash	+\$0
LBC	walnut on ash	+\$0
LBF	neutral twill	+\$0
LBJ	graphite twill	+\$0
LBQ	white twill	+\$0
LU	soft white	+\$0
WL	sandstone	+\$0
WN	warm grey neutral	+\$0

Top Finish
For thermally-fused laminate top/thermoplastic edge (M), thermally-fused laminate top/universal edge (T), thermally-fused laminate top/thermoplastic edge with MicrobeCare™ (I), or thermally-fused laminate top/universal edge with MicrobeCare™ (K)

8Q	folkstone grey	+\$0
91	white	+\$0
98	studio white	+\$0
HM	natural maple	+\$0
LBA	clear on ash	+\$0
LBB	oak on ash	+\$0
LBC	walnut on ash	+\$0
LBF	neutral twill	+\$0
LBQ	white twill	+\$0
LBU	medium matte walnut	+\$0

Top/Edge Finish: Wood Veneer
For veneer top/veneer edge (W) or veneer top/veneer edge with MicrobeCare™ (B)

2U	light brown walnut <input type="checkbox"/> A	+\$50
40	dark brown walnut <input type="checkbox"/> A	+\$50
CHD	noble cherry	+\$50
ET	clear on ash <input type="checkbox"/> A	+\$50
EU	oak on ash <input type="checkbox"/> A	+\$50
EV	walnut on ash <input type="checkbox"/> A	+\$50
EW	medium matte walnut <input type="checkbox"/> A	+\$50
UL	natural maple <input type="checkbox"/> A	+\$50
WHN	natural white oak	+\$50

Top/Edge Finish: Opaque Formcoat®
For painted Formcoat® top/edge (P)

8Q	folkstone grey	+\$0
91	white	+\$0
LU	soft white	+\$0

Step 8. Edge Finish

For high-pressure laminate top/thermoplastic edge (L), thermally-fused laminate top/thermoplastic edge (M), high-pressure laminate top/thermoplastic edge with MicrobeCare™ (A), or thermally-fused laminate top/thermoplastic edge with MicrobeCare™ (I)

76	light brown walnut	+\$0
8Q	folkstone grey	+\$0
91	white	+\$0
98	studio white	+\$0
CL	cool grey neutral	+\$0
LBA	clear on ash	+\$0
LBR	phantom ecru	+\$0
LBS	phantom cocoa	+\$0
LBU	medium matte walnut	+\$0
LBV	warm grey teak	+\$0
LBB	oak on ash	+\$0
LBC	walnut on ash	+\$0
LBF	neutral twill	+\$0
LBJ	graphite twill	+\$0
LBQ	white twill	+\$0
WL	sandstone	+\$0
WN	warm grey neutral	+\$0
HF	inner tone light	+\$0
HM	natural maple	+\$0
HP	light anigre	+\$0
HX	aged cherry	+\$0
LU	soft white	+\$0

Rectangular Table *continued*

For high-pressure laminate/universal edge (U), thermally-fused laminate top/universal edge (T), high-pressure laminate top/universal edge with MicrobeCare™ (C), or thermally-fused laminate top/universal edge with MicrobeCare™ (K)

PLY	plywood edge	+\$50
------------	--------------	-------

Step 9. Leg Finish

Metallic Paint

For post leg (P), T-leg (T), or C-leg (C)

CN	metallic champagne	+\$0
EH	metallic bronze	+\$0
MS	metallic silver	+\$0
SNA	satin aluminum	+\$30
SNB	satin bronze	+\$30
SNC	satin carbon	+\$30

Sand Texture Paint

For post leg (P), T-leg (T), or C-leg (C)

BK	black	+\$0
-----------	-------	------

Smooth Paint

For post leg (P), T-leg (T), or C-leg (C)

8Q	folkstone grey	+\$0
91	white	+\$0
98	studio white	+\$0
BU	black umber	+\$0
CL	cool grey neutral	+\$0
G2	graphite satin	+\$0
HF	inner tone light	+\$0
LU	soft white	+\$0
MT	medium tone	+\$0
SG	slate grey	+\$0
WL	sandstone	+\$0
WN	warm grey neutral	+\$0

For post leg (P), T-leg (T), or C-leg (C)

CD	polished aluminum	+\$110
-----------	-------------------	--------

Metallic Paint

For T-leg with height adjustment (A) or C-leg with height adjustment (D)

CN	metallic champagne	+\$0
EH	metallic bronze	+\$0
MS	metallic silver	+\$0
SNA	satin aluminum	+\$30
SNB	satin bronze	+\$30
SNC	satin carbon	+\$30

Smooth Paint

For T-leg with height adjustment (A) or C-leg with height adjustment (D)

8Q	folkstone grey	+\$0
91	white	+\$0
98	studio white	+\$0
BU	black umber	+\$0
CL	cool grey neutral	+\$0
G2	graphite satin	+\$0
HF	inner tone light	+\$0
LU	soft white	+\$0
MT	medium tone	+\$0
SG	slate grey	+\$0
WL	sandstone	+\$0
WN	warm grey neutral	+\$0

For T-leg with height adjustment (A) or C-leg with height adjustment (D)

CD	polished aluminum	+\$110
-----------	-------------------	--------

Step 10. Casters/Glides

20	casters	+\$0
57	glides	+\$0

Step 11. Grommets

For squared-edge (S.) with 18" deep (18)

NTG	no grommet	+\$0
------------	------------	------

For squared-edge (S.) with 24" deep (24), or 30" deep (30)

NTG	no grommet	+\$0
253	cutout for Y1420. or Y1425. - 3 port	+\$27
254	cutout for Y1420. or Y1425. - 5 port	+\$27
255	cutout for Y1420. or Y1425. - 6 port	+\$27

Rectangular Table *continued*

For squared-edge (S.) with 36" deep (36)

NTG	no grommet	+\$0
253	cutout for Y1420. or Y1425. - 3 port	+\$27
254	cutout for Y1420. or Y1425. - 5 port	+\$27
255	cutout for Y1420. or Y1425. - 6 port	+\$27

For thin-edge (T.) or eased-edge (E.) with 24" deep (24), or 30" deep (30), or 36" deep (36)

NTG	no grommet	+\$0
253	cutout for Y1420. or Y1425. - 3 port	+\$27
254	cutout for Y1420. or Y1425. - 5 port	+\$27
255	cutout for Y1420. or Y1425. - 6 port	+\$27

Square Table

DT1BE.
DT1BS.
DT1BT.

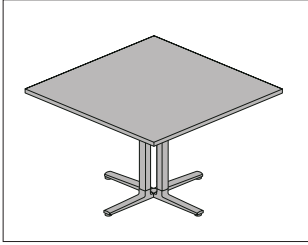

Everywhere™ Standard-Height Tables

Product Information

Description

This square table comes in multiple edge styles and has a laminate top with thermoplastic edge, laminate top with a thermoplastic backed plywood edge, veneer top and edge, or painted top and edge. It has multiple leg/base options, and is available with casters or glides. The caster option has 2 locking and 2 non-locking casters. Glides have 1/2" leveling range. Shipped knocked down.

Notes

48" tops available only with post leg option for optimum stability.

42" top (4242) with 4-column base (X) available only with glides.

Casters are not compatible with this top/base combination.

For additional details on available edge options see Appendices.

For additional size, edge, and finish options, see Vary Easy Program in Appendices.

UL listed when used with Connect™ single circuit electrical product (Y137x.) with post leg (P) option.

MicrobeCare™ is an antimicrobial coating that can be applied to a wide variety of Herman Miller Group surfaces to protect products from mold, mildew, algae, and bacteria that cause deterioration, discoloration, odors, and stains.

MicrobeCare™ is a US Environmental Protection Agency (EPA) registered nonpublic health antimicrobial.

Dimensions

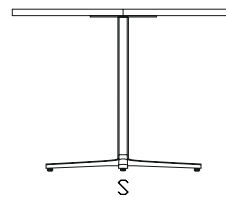
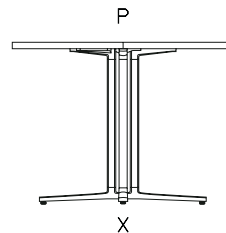
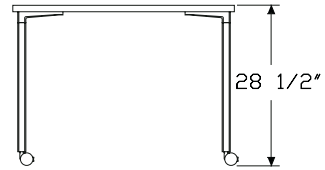
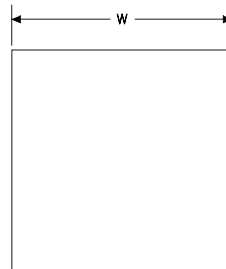

Specification Information

Step 1.

DT1B

Step 2. Edge

- S.** squared-edge
- T.** thin-edge
- E.** eased-edge

Step 3. Depth/Width

- 3030** 30" deep x 30" wide
- 3636** 36" deep x 36" wide
- 4242** 42" deep x 42" wide
- 4848** 48" deep x 48" wide

Step 4. Surface Material

For squared-edge (S.)

- L** high-pressure laminate top/thermoplastic edge
- M** thermally-fused laminate top/thermoplastic edge
- U** high-pressure laminate/universal edge
- T** thermally-fused laminate top/universal edge
- W** veneer top/veneer edge A
- P** painted Formcoat® top/edge
- A** high-pressure laminate top/thermoplastic edge with MicrobeCare™ A
- J** thermally-fused laminate top/thermoplastic edge with MicrobeCare™ A
- B** veneer top/veneer edge with MicrobeCare™ A
- C** high-pressure laminate top/universal edge with MicrobeCare™ A
- K** thermally-fused laminate top/universal edge with MicrobeCare™ A

For thin-edge (T.)

- W** veneer top/veneer edge A
- P** painted Formcoat® top/edge
- B** veneer top/veneer edge with MicrobeCare™ A

For eased-edge (E.)

- P** painted Formcoat® top/edge

Step 5. Leg/Base Type

For 30" deep x 30" wide (3030)

- P** post leg
- X** 4-column base
- S** single-column base A

For 36" deep x 36" wide (3636)

- P** post leg
- X** 4-column base
- S** single-column base A

For 42" deep x 42" wide (4242)

- P** post leg
- X** 4-column base

For 48" deep x 48" wide (4848)

- P** post leg

Prices for Steps 1-5.

	P	X	S
DT1BS. 3030 L	\$1018	1317	1123
M	\$952	1233	1051
U	\$1018	1317	1123
T	\$952	1233	1051
W	\$1214	1601	1348
P	\$1106	1437	1222
A	\$1098	1397	1205
J	\$1028	1308	1129
B	\$1291	1678	1426
C	\$1098	1397	1205
K	\$1028	1308	1129
3636 L	\$1219	1579	1345
M	\$1142	1479	1260
U	\$1219	1579	1345
T	\$1142	1479	1260
W	\$1474	1935	1638
P	\$1329	1721	1463
A	\$1299	1661	1427
J	\$1217	1555	1336
B	\$1551	2013	1715
C	\$1299	1661	1427
K	\$1217	1555	1336

4242 L	\$1399	1815	—
M	\$1311	1700	—
U	\$1399	1815	—
T	\$1311	1700	—
W	\$1702	2235	—
P	\$1522	1975	—
A	\$1482	1896	—
J	\$1387	1776	—
B	\$1779	2314	—
C	\$1482	1896	—
K	\$1387	1776	—
4848 L	\$1566	—	—
M	\$1467	—	—
U	\$1566	—	—
T	\$1467	—	—
W	\$1999	—	—
P	\$1703	—	—
A	\$1668	—	—
J	\$1563	—	—
B	\$2494	—	—
C	\$2211	—	—
K	\$2071	—	—
	P	X	S
DT1BT. 3030 W	\$1456	1922	1619
P	\$1180	1532	1301
B	\$1534	1999	1697
3636 W	\$1767	2323	1962
P	\$1411	1830	1557
B	\$1844	2399	2041
4242 W	\$2042	2685	—
P	\$1620	2105	—
B	\$2118	2763	—
4848 W	\$2397	—	—
P	\$1816	—	—
B	\$2494	—	—
	P	X	S
DT1BE. 3030 P	\$1180	1532	1301
3636 P	\$1411	1830	1557
4242 P	\$1620	2105	—
4848 P	\$1816	—	—

Step 6.

Top Finish

For high-pressure laminate top/thermoplastic edge (L), high-pressure laminate/universal edge (U), high-pressure laminate top/thermoplastic edge with MicrobeCare™ (A), or high-pressure laminate top/universal edge with MicrobeCare™ (C)

76	light brown walnut	+\$0
91	white	+\$0
98	studio white	+\$0
8Q	folkstone grey	+\$0
CL	cool grey neutral	+\$0
HF	inner tone light	+\$0
HM	natural maple	+\$0
HP	light anigre	+\$0
HX	aged cherry	+\$0
LBA	clear on ash	+\$0
LBR	phantom ecru	+\$0
LBS	phantom cocoa	+\$0
LBU	medium matte walnut	+\$0
LBV	warm grey teak	+\$0
LBB	oak on ash	+\$0
LBC	walnut on ash	+\$0
LBF	neutral twill	+\$0
LBJ	graphite twill	+\$0
LBQ	white twill	+\$0
LU	soft white	+\$0
WL	sandstone	+\$0
WN	warm grey neutral	+\$0

Top Finish

For thermally-fused laminate top/thermoplastic edge (M), thermally-fused laminate top/universal edge (T), thermally-fused laminate top/thermoplastic edge with MicrobeCare™ (I), or thermally-fused laminate top/universal edge with MicrobeCare™ (K)

8Q	folkstone grey	+\$0
91	white	+\$0
98	studio white	+\$0
HM	natural maple	+\$0
LBA	clear on ash	+\$0
LBB	oak on ash	+\$0
LBC	walnut on ash	+\$0
LBF	neutral twill	+\$0
LBQ	white twill	+\$0
LBU	medium matte walnut	+\$0

Top/Edge Finish: Wood Veneer		
<i>For veneer top/veneer edge (W) or veneer top/veneer edge with MicrobeCare™ (B)</i>		
2U	light brown walnut A	+\$50
40	dark brown walnut A	+\$50
CHD	noble cherry	+\$50
ET	clear on ash A	+\$50
EU	oak on ash A	+\$50
EV	walnut on ash A	+\$50
EW	medium matte walnut A	+\$50
UL	natural maple A	+\$50
WHN	natural white oak	+\$50

Top/Edge Finish: Opaque Formcoat®		
<i>For painted Formcoat® top/edge (P)</i>		
8Q	folkstone grey	+\$0
91	white	+\$0
LU	soft white	+\$0

Step 7. Edge Finish

<i>For high-pressure laminate top/thermoplastic edge (L), thermally-fused laminate top/thermoplastic edge (M), high-pressure laminate top/thermoplastic edge with MicrobeCare™ (A), or thermally-fused laminate top/thermoplastic edge with MicrobeCare™ (I)</i>		
76	light brown walnut	+\$0
8Q	folkstone grey	+\$0
91	white	+\$0
98	studio white	+\$0
CL	cool grey neutral	+\$0
LBA	clear on ash	+\$0
LBR	phantom ecru	+\$0
LBS	phantom cocoa	+\$0
LBU	medium matte walnut	+\$0
LBV	warm grey teak	+\$0
LBB	oak on ash	+\$0
LBC	walnut on ash	+\$0
LBF	neutral twill	+\$0
LBJ	graphite twill	+\$0
LBQ	white twill	+\$0
WL	sandstone	+\$0
WN	warm grey neutral	+\$0
HF	inner tone light	+\$0
HM	natural maple	+\$0
HP	light anigre	+\$0
HX	aged cherry	+\$0
LU	soft white	+\$0

<i>For high-pressure laminate/universal edge (U), thermally-fused laminate top/universal edge (T), high-pressure laminate top/universal edge with MicrobeCare™ (C), or thermally-fused laminate top/universal edge with MicrobeCare™ (K)</i>		
PLY	plywood edge	+\$50

Step 8. Leg Finish

Metallic Paint		
CN	metallic champagne	+\$0
EH	metallic bronze	+\$0
MS	metallic silver	+\$0
SNA	satin aluminum	+\$30
SNB	satin bronze	+\$30
SNC	satin carbon	+\$30

Sand Texture Paint

BK	black	+\$0
-----------	-------	------

Smooth Paint

8Q	folkstone grey	+\$0
91	white	+\$0
98	studio white A	+\$0
BU	black umber	+\$0
CL	cool grey neutral	+\$0
G2	graphite satin	+\$0
HF	inner tone light	+\$0
LU	soft white	+\$0
MT	medium tone	+\$0
SG	slate grey	+\$0
WL	sandstone	+\$0
WN	warm grey neutral	+\$0
CD	polished aluminum	+\$110

Step 9. Casters/Glides

<i>For post leg (P) or single-column base (S)</i>		
20	casters	+\$0
57	glides	+\$0

<i>For 4-column base (X)</i>		
20	casters	+\$0
57	glides	+\$0

<i>For 4-column base (X)</i>		
57	glides	+\$0

Round Table

DT1CE.
DT1CS.
DT1CT.

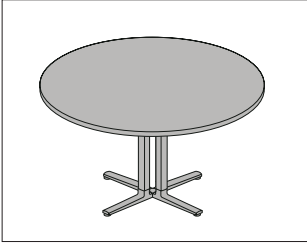

Product Information

Description

This round table comes in multiple edge styles and has a laminate top with thermoplastic edge, veneer top and edge, or painted top and edge. It has multiple leg/base options, and is available with casters or glides. The caster option has 2 locking and 2 non-locking casters. Glides have 1/2" leveling range. Shipped knocked down.

Notes

48" and 60" tops available only with post leg option for optimum stability.

For additional details on available edge options see Appendices.

For additional size, edge, and finish options, see Vary Easy Program in Appendices.

UL listed when used with Connect™ single circuit electrical product (Y137x.) with post leg (P) option.

MicrobeCare™ is an antimicrobial coating that can be applied to a wide variety of Herman Miller Group surfaces to protect products from mold, mildew, algae, and bacteria that cause deterioration, discoloration, odors, and stains.

MicrobeCare™ is a US Environmental Protection Agency (EPA) registered nonpublic health antimicrobial.

Dimensions

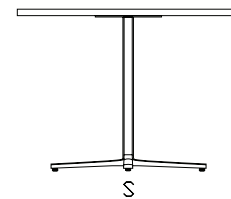
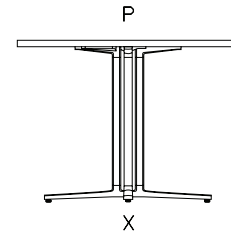
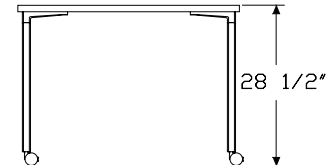
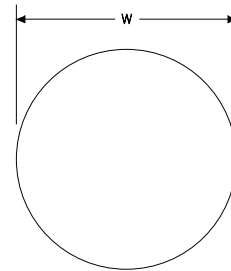

Round Table *continued*

Specification Information

Step 1.

DT1C

Step 2. Edge

- S.** squared-edge
- T.** thin-edge
- E.** eased-edge

Step 3. Diameter

- 30** 30" diameter
- 36** 36" diameter
- 42** 42" diameter
- 48** 48" diameter
- 60** 60" diameter

Step 4. Surface Material

For squared-edge (S.)

- L** high-pressure laminate top/thermoplastic edge
- M** thermally-fused laminate top/thermoplastic edge
- W** veneer top/veneer edge A
- P** painted Formcoat® top/edge
- A** high-pressure laminate top/thermoplastic edge with MicrobeCare™ A
- J** thermally-fused laminate top/thermoplastic edge with MicrobeCare™ A
- B** veneer top/veneer edge with MicrobeCare™ A

For thin-edge (T.)

- W** veneer top/veneer edge A
- P** painted Formcoat® top/edge
- B** veneer top/veneer edge with MicrobeCare™ A

For eased-edge (E.)

- P** painted Formcoat® top/edge

Step 5. Leg/Base Type

For 30" diameter (30) or 36" diameter (36)

- P** post leg
- X** 4-column base
- S** single-column base A

For 42" diameter (42)

- P** post leg
- X** 4-column base

For 48" diameter (48) or 60" diameter (60)

- P** post leg

Prices for Steps 1-5.

	P	X	S	
DT1CS. 30 L	\$1173	1528	1299	
M	\$1089	1418	1205	
W	\$1397	1839	1550	
P	\$1272	1652	1405	
A	\$1256	1610	1381	
J	\$1165	1494	1282	
B	\$1475	1917	1627	
36 L	\$1413	1829	1490	
M	\$1311	1697	1383	
W	\$1397	2225	1878	
P	\$1525	1975	1610	
A	\$1495	1911	1572	
J	\$1387	1773	1458	
B	\$1475	2302	1957	
42 L	\$1618	2009	—	
M	\$1501	1863	—	
W	\$1960	2572	—	
P	\$1750	2172	—	
A	\$1699	2089	—	
J	\$1577	1939	—	
B	\$2038	2650	—	
48 L	\$1810	—	—	
M	\$1679	—	—	
W	\$2297	—	—	
P	\$1961	—	—	
A	\$1912	—	—	
J	\$1774	—	—	
B	\$2395	—	—	
60 L	\$1977	—	—	
M	\$1834	—	—	
W	\$2516	—	—	
P	\$2134	—	—	
A	\$2081	—	—	
J	\$1930	—	—	
B	\$2612	—	—	
		P	X	S
DT1CT. 30 W	\$1676	2208	1862	
P	\$1353	1759	1496	
B	\$1752	2287	1938	

36 W	\$1676	2670	2256	
P	\$1622	2105	1715	
B	\$1752	2749	2332	
42 W	\$2350	3085	—	
P	\$1866	2315	—	
B	\$2427	3163	—	
48 W	\$2755	—	—	
P	\$2086	—	—	
B	\$2852	—	—	
60 W	\$3015	—	—	
P	\$2273	—	—	
B	\$3113	—	—	
		P	X	S
DT1CE. 30 P	\$1353	1759	1496	
36 P	\$1622	2105	1715	
42 P	\$1866	2315	—	
48 P	\$2086	—	—	
60 P	\$2273	—	—	

Step 6.

Top Finish

For high-pressure laminate top/thermoplastic edge (L) or high-pressure laminate top/thermoplastic edge with MicrobeCare™ (A)

38	twilight	+\$0
39	desert	+\$0
76	light brown walnut	+\$0
91	white	+\$0
98	studio white	+\$0
8Q	folkstone grey	+\$0
CL	cool grey neutral	+\$0
HF	inner tone light	+\$0
HM	natural maple	+\$0
HP	light anigre	+\$0
HX	aged cherry	+\$0
LBA	clear on ash	+\$0
LBR	phantom ecru	+\$0
LBS	phantom cocoa	+\$0
LBU	medium matte walnut	+\$0
LBV	warm grey teak	+\$0
LBB	oak on ash	+\$0
LBC	walnut on ash	+\$0
LBF	neutral twill	+\$0
LBJ	graphite twill	+\$0
LBQ	white twill	+\$0
LU	soft white	+\$0
WL	sandstone	+\$0
WN	warm grey neutral	+\$0

Top Finish

For thermally-fused laminate top/thermoplastic edge (M) or thermally-fused laminate top/thermoplastic edge with MicrobeCare™ (I)

8Q	folkstone grey	+\$0
91	white	+\$0
98	studio white	+\$0
HM	natural maple	+\$0
LBA	clear on ash	+\$0
LBB	oak on ash	+\$0
LBC	walnut on ash	+\$0
LBF	neutral twill	+\$0
LBQ	white twill	+\$0
LBU	medium matte walnut	+\$0

Round Table *continued*

Top/Edge Finish: Wood Veneer

For veneer top/veneer edge (W) or veneer top/veneer edge with MicrobeCare™ (B)

2U	light brown walnut A	+\$50
40	dark brown walnut A	+\$50
CHD	noble cherry	+\$50
ET	clear on ash A	+\$50
EU	oak on ash A	+\$50
EV	walnut on ash A	+\$50
EW	medium matte walnut A	+\$50
UL	natural maple A	+\$50
WHN	natural white oak	+\$50

Top/Edge Finish: Opaque Formcoat®

For painted Formcoat® top/edge (P)

8Q	folkstone grey	+\$0
91	white	+\$0
LU	soft white	+\$0

Step 7. Edge Finish

For high-pressure laminate top/thermoplastic edge (L), thermally-fused laminate top/thermoplastic edge (M), high-pressure laminate top/thermoplastic edge with MicrobeCare™ (A), or thermally-fused laminate top/thermoplastic edge with MicrobeCare™ (J)

76	light brown walnut	+\$0
8Q	folkstone grey	+\$0
91	white	+\$0
98	studio white	+\$0
CL	cool grey neutral	+\$0
LBA	clear on ash	+\$0
LBR	phantom ecru	+\$0
LBS	phantom cocoa	+\$0
LBU	medium matte walnut	+\$0
LBV	warm grey teak	+\$0
LBB	oak on ash	+\$0
LBC	walnut on ash	+\$0
LBF	neutral twill	+\$0
LBJ	graphite twill	+\$0
LBQ	white twill	+\$0
WL	sandstone	+\$0
WN	warm grey neutral	+\$0
HF	inner tone light	+\$0
HM	natural maple	+\$0
HP	light anigre	+\$0
HX	aged cherry	+\$0
LU	soft white	+\$0

Step 8. Leg/Base Finish

Metallic Paint

CN	metallic champagne	+\$0
EH	metallic bronze	+\$0
MS	metallic silver	+\$0
SNA	satin aluminum	+\$30
SNB	satin bronze	+\$30
SNC	satin carbon	+\$30

Sand Texture Paint

BK	black	+\$0
-----------	-------	------

Smooth Paint

8Q	folkstone grey	+\$0
91	white	+\$0
98	studio white A	+\$0
BU	black umber	+\$0
CL	cool grey neutral	+\$0
G2	graphite satin	+\$0
HF	inner tone light	+\$0
LU	soft white	+\$0
MT	medium tone	+\$0
SG	slate grey	+\$0
WL	sandstone	+\$0
WN	warm grey neutral	+\$0
CD	polished aluminum	+\$110

Step 9. Casters/Glides

20	casters	+\$0
57	glides	+\$0

Oval Table

DT1DE.
DT1DS.
DT1DT.

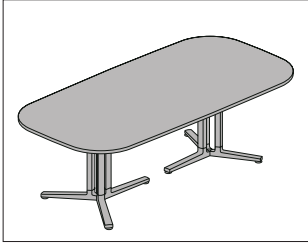

Everywhere™ Standard-Height Tables

Product Information

Description

This oval table comes in multiple edge styles and has a laminate top with thermoplastic edge, veneer top and edge, or painted top and edge. It has multiple leg/base options, and is available with casters or glides. The caster option has 2 locking and 2 non-locking casters. Glides have 1/2" leveling range. Shipped knocked down.

Notes

When specifying grommets (253, 254, 255), cutouts will be located in the center of table.

Cutouts available for all Connect™ power and data accessories (see Thrive™ Portfolio). Cutouts will be located in the center, laterally and front to back.

For additional details on available edge options see Appendices.

For additional size, edge, and finish options, see Vary Easy Program in Appendices.

Dimensions

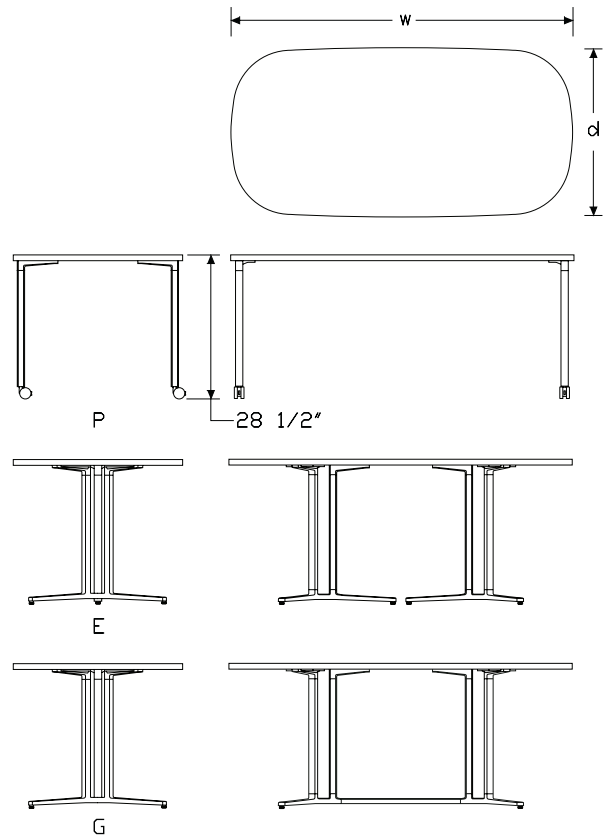

Oval Table *continued*

Specification Information

Step 1.

DT1D

Step 2. Edge

- S.** squared-edge
- T.** thin-edge
- E.** eased-edge

Step 3. Depth

- 30** 30" deep
- 36** 36" deep
- 42** 42" deep

Step 4. Width

For 30" deep (30)

- 48** 48" wide
- 60** 60" wide

For 36" deep (36)

- 60** 60" wide
- 72** 72" wide

For 42" deep (42)

- 72** 72" wide
- 84** 84" wide

Step 5. Surface Material

For squared-edge (S.)

- M** thermally-fused laminate top/thermoplastic edge
- L** high-pressure laminate top/thermoplastic edge
- W** veneer top/veneer edge **A**
- P** painted Formcoat® top/edge

For thin-edge (T.)

- W** veneer top/veneer edge **A**
- P** painted Formcoat® top/edge

For eased-edge (E.)

- P** painted Formcoat® top/edge

Step 6. Leg/Base Type

For 48" wide (48) or 60" wide (60)

- P** post leg
- G** double 3-column base, spanner

For 72" wide (72) or 84" wide (84)

- P** post leg
- E** double 3-column base
- G** double 3-column base, spanner

Prices for Steps 1-6.

	MP	ME	MG	LP	LE	LG
DT1DS. 30 48	\$1274	—	2097	1386	—	2282
60	\$1376	—	2266	1497	—	2465
36 60	\$1526	—	2515	1661	—	2736
72	\$1754	2978	2893	1908	3239	3147
42 72	\$1877	3188	3094	2042	3467	3366
84	\$1932	3276	3178	2102	3563	3457

	WP	WE	WG	PP	PE	PG
DT1DS. 30 48	\$1918	—	3218	1488	—	2453
60	\$2078	—	3482	1607	—	2647
36 60	\$2318	—	3875	1781	—	2938
72	\$2675	4605	4470	2051	3480	3379
42 72	\$2871	4934	4790	2194	3721	3613
84	\$2953	5074	4928	2256	3826	3714

	WP	WE	WG	PP	PE	PG
DT1DT. 30 48	\$2301	—	3859	1584	—	2608
60	\$2491	—	4175	1711	—	2814
36 60	\$2782	—	4650	1899	—	3128
72	\$3213	5525	5365	2183	3705	3596
42 72	\$3447	5922	5747	2335	3962	3847
84	\$3539	6091	5912	2403	4075	3954

	WP	WE	WG	PP	PE	PG
DT1DE. 30 48	—	—	—	\$1584	—	2608
60	—	—	—	\$1711	—	2814
36 60	—	—	—	\$1899	—	3128
72	—	—	—	\$2183	3705	3596
42 72	—	—	—	\$2335	3962	3847
84	—	—	—	\$2403	4075	3954

Oval Table *continued*

Step 7.

Top Finish

For high-pressure laminate top/thermoplastic edge (L)

28	canyon	+\$0
29	misted	+\$0
38	twilight	+\$0
39	desert	+\$0
76	light brown walnut	+\$0
8Q	folkstone grey	+\$0
91	white	+\$0
98	studio white	+\$0
CL	cool grey neutral	+\$0
HF	inner tone light	+\$0
HM	natural maple	+\$0
HP	light anigre	+\$0
HX	aged cherry	+\$0
LBA	clear on ash	+\$0
LBB	oak on ash	+\$0
LBC	walnut on ash	+\$0
LBF	neutral twill	+\$0
LBJ	graphite twill	+\$0
LBQ	white twill	+\$0
LBR	phantom ecru	+\$0
LBS	phantom cocoa	+\$0
LBU	medium matte walnut	+\$0
LBV	warm grey teak	+\$0
LT	light tone A	+\$0
LU	soft white	+\$0
WL	sandstone	+\$0
WN	warm grey neutral	+\$0
X1	chalk white A	+\$0

Top Finish

For thermally-fused laminate top/thermoplastic edge (M)

8Q	folkstone grey	+\$0
91	white	+\$0
98	studio white	+\$0
HM	natural maple	+\$0
LBA	clear on ash	+\$0
LBB	oak on ash	+\$0
LBC	walnut on ash	+\$0
LBF	neutral twill	+\$0
LBQ	white twill	+\$0
LBU	medium matte walnut	+\$0

Top/Edge Finish: Wood Veneer

For veneer top/veneer edge (W)

2U	light brown walnut A	+\$50
40	dark brown walnut A	+\$50
CHD	noble cherry	+\$50
ET	clear on ash A	+\$50
EU	oak on ash A	+\$50
EV	walnut on ash A	+\$50
EW	medium matte walnut A	+\$50
UL	natural maple A	+\$50
WHN	natural white oak	+\$50

Top/Edge Finish: Opaque Formcoat®

For painted Formcoat® top/edge (P)

8Q	folkstone grey	+\$0
91	white	+\$0
LU	soft white	+\$0

Oval Table *continued*

Step 8. Edge Finish

For thermally-fused laminate top/thermoplastic edge (M) or high-pressure laminate top/thermoplastic edge (L)

28	canyon	+\$0
29	misted	+\$0
38	twilight	+\$0
39	desert	+\$0
76	light brown walnut	+\$0
8Q	folkstone grey	+\$0
91	white	+\$0
98	studio white	+\$0
BU	black umber A	+\$0
CL	cool grey neutral	+\$0
G2	graphite satin	+\$0
HF	inner tone light	+\$0
HM	natural maple	+\$0
HP	light anigre	+\$0
HX	aged cherry	+\$0
LBA	clear on ash	+\$0
LBB	oak on ash	+\$0
LBC	walnut on ash	+\$0
LBF	neutral twill	+\$0
LBJ	graphite twill	+\$0
LBQ	white twill	+\$0
LBR	phantom ecru	+\$0
LBS	phantom cocoa	+\$0
LBU	medium matte walnut	+\$0
LBV	warm grey teak	+\$0
LT	light tone A	+\$0
LU	soft white	+\$0
SG	slate grey	+\$0
WL	sandstone	+\$0
WN	warm grey neutral	+\$0
X1	chalk white A	+\$0

Step 9. Leg/Base Finish

Metallic Paint

CN	metallic champagne	+\$0
EH	metallic bronze	+\$0
MS	metallic silver	+\$0
SNA	satin aluminum	+\$30
SNB	satin bronze	+\$30
SNC	satin carbon	+\$30

Sand Texture Paint

BK	black	+\$0
-----------	-------	------

Smooth Paint

8Q	folkstone grey	+\$0
91	white	+\$0
98	studio white	+\$0
BU	black	+\$0
CL	cool grey neutral	+\$0
G2	graphite satin	+\$0
HF	inner tone light	+\$0
LU	soft white	+\$0
MT	medium tone	+\$0
SG	slate grey	+\$0
WL	sandstone	+\$0
WN	warm grey neutral	+\$0
CD	polished aluminum	+\$110

Step 10. Casters/Glides

20	casters	+\$0
57	glides	+\$0

Step 11. Grommets

NTG	no grommet	+\$0
253	cutout for Y1420. or Y1425. - 3 port	+\$27
254	cutout for Y1420. or Y1425. - 5 port	+\$27
255	cutout for Y1420. or Y1425. - 6 port	+\$27

D-Shaped Table

DT1EE.
DT1ES.
DT1ET.

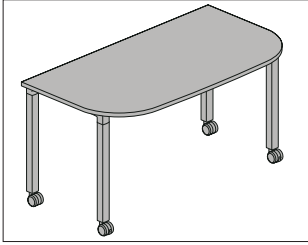

Product Information

Description

This D-shaped table comes in multiple edge styles and has a laminate top with thermoplastic edge, veneer top and edge, or painted top and edge. It has multiple leg options, and is available with casters or glides. The caster option has 2 locking and 2 non-locking casters. Glides have 1/2" leveling range. Shipped knocked down. Height-adjustable legs have a 5" range in 1" increments.

Notes

Thin edge and eased edge tops available only with 30" deep surfaces. T-leg and T-leg with height adjustment cannot be used with 18" deep tops.

Cable grommet options available through Vary Easy Program for round pass through grommet with 2 1/4" hole clearance. Holes are located 3" from rear edge and 6" from end for the L and R options. Covers not provided with painted surface option.

Cutouts available for all Connect™ power and data accessories (see Thrive™ Portfolio). Cutouts will be located in the center, laterally, and approximately 3" from the rear edge of surface.

Reinforcement channels are used under table tops 54" and wider. They will be located along the center line for 18" deep and 24" deep surfaces, and 19" from the front edge for 30" deep surfaces.

For additional details on available edge options see Appendices.

For additional size, edge, and finish options, see Vary Easy Program in Appendices.

UL listed when used with Connect single circuit electrical product (Y137x.) with post leg (P) and T-leg (T) options.

Dimensions

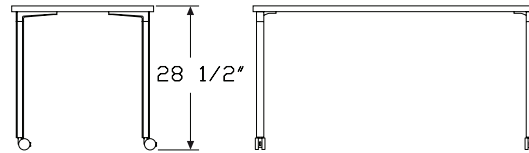
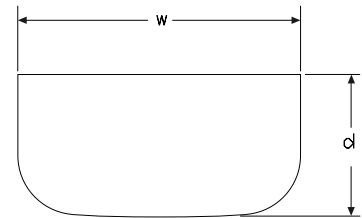

P

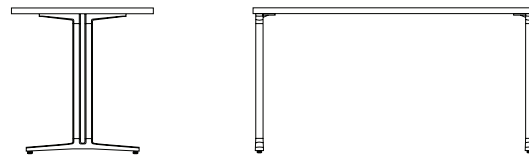

T

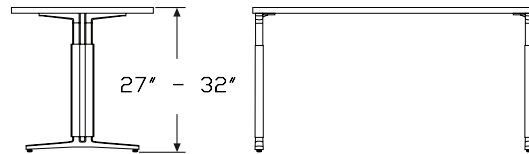

A

D-Shaped Table *continued*

Specification Information

Step 1.

DT1E

Step 2. Edge

- S.** squared-edge
- T.** thin-edge
- E.** eased-edge

Step 3. Depth/Width

For thin-edge (T.) or eased-edge (E.)

3060 30" deep x 60" wide

For squared-edge (S.)

1836 18" deep x 36" wide

2448 24" deep x 48" wide

3060 30" deep x 60" wide

Step 4. Surface Material

For squared-edge (S.)

- L** high-pressure laminate top/thermoplastic edge
- M** thermally-fused laminate top/thermoplastic edge
- W** veneer top/veneer edge A
- P** painted Formcoat® top/edge

For thin-edge (T.)

- W** veneer top/veneer edge A
- P** painted Formcoat® top/edge

For eased-edge (E.)

- P** painted Formcoat® top/edge

Step 5. Leg Type

For 18" deep x 36" wide (1836)

- P** post leg

For 30" deep x 60" wide (3060) or 24" deep x 48" wide (2448)

- P** post leg
- T** T-leg
- A** T-leg with height adjustment

Prices for Steps 1-5.

	P	T	A
DT1ES. 1836 L	\$1096	—	—
M	\$1019	—	—
W	\$1203	—	—
P	\$1188	—	—
2448 L	\$1315	2062	2496
M	\$1222	1915	2319
W	\$1459	2185	2776
P	\$1424	2231	2701
3060 L	\$1512	2369	2865
M	\$1404	2201	2661
W	\$1689	2537	3222
P	\$1634	2562	3101
	P	T	A
DT1ET. 3060 W	\$2023	3046	3867
P	\$1738	2730	3302
	P	T	A
DT1EE. 3060 P	\$1738	2730	3302

D-Shaped Table *continued*

Step 6.

Top Finish

For high-pressure laminate top/thermoplastic edge (L)

28	canyon	+\$0
29	misted	+\$0
38	twilight	+\$0
39	desert	+\$0
76	light brown walnut	+\$0
91	white	+\$0
98	studio white	+\$0
8Q	folkstone grey	+\$0
CL	cool grey neutral	+\$0
HF	inner tone light	+\$0
HM	natural maple	+\$0
HP	light anigre	+\$0
HX	aged cherry	+\$0
LBA	clear on ash	+\$0
LBR	phantom ecru	+\$0
LBS	phantom cocoa	+\$0
LBU	medium matte walnut	+\$0
LBV	warm grey teak	+\$0
LBB	oak on ash	+\$0
LBC	walnut on ash	+\$0
LBF	neutral twill	+\$0
LBJ	graphite twill	+\$0
LBQ	white twill	+\$0
LT	light tone	+\$0
LU	soft white	+\$0
WL	sandstone	+\$0
WN	warm grey neutral	+\$0
X1	chalk white	+\$0

Top Finish

For thermally-fused laminate top/thermoplastic edge (M)

8Q	folkstone grey	+\$0
91	white	+\$0
98	studio white	+\$0
HM	natural maple	+\$0
LBA	clear on ash	+\$0
LBB	oak on ash	+\$0
LBC	walnut on ash	+\$0
LBF	neutral twill	+\$0
LBQ	white twill	+\$0
LBU	medium matte walnut	+\$0

Top/Edge Finish: Wood Veneer

For veneer top/veneer edge (W)

2U	light brown walnut A	+\$50
40	dark brown walnut A	+\$50
CHD	noble cherry	+\$50
ET	clear on ash A	+\$50
EU	oak on ash A	+\$50
EV	walnut on ash A	+\$50
EW	medium matte walnut A	+\$50
UL	natural maple A	+\$50
WHN	natural white oak	+\$50

Top/Edge Finish: Opaque Formcoat®

For painted Formcoat® top/edge (P)

8Q	folkstone grey	+\$0
91	white	+\$0
LU	soft white	+\$0

Step 7. Edge Finish

For high-pressure laminate top/thermoplastic edge (L) or thermally-fused laminate top/thermoplastic edge (M)

76	light brown walnut	+\$0
8Q	folkstone grey	+\$0
91	white	+\$0
98	studio white	+\$0
CL	cool grey neutral	+\$0
LBA	clear on ash	+\$0
LBR	phantom ecru	+\$0
LBS	phantom cocoa	+\$0
LBU	medium matte walnut	+\$0
LBV	warm grey teak	+\$0
LBB	oak on ash	+\$0
LBC	walnut on ash	+\$0
LBF	neutral twill	+\$0
LBJ	graphite twill	+\$0
LBQ	white twill	+\$0
WL	sandstone	+\$0
WN	warm grey neutral	+\$0
HF	inner tone light	+\$0
HM	natural maple	+\$0
HP	light anigre	+\$0
HX	aged cherry	+\$0
LU	soft white	+\$0

D-Shaped Table *continued*

Step 8. Leg Finish

Metallic Paint

For post leg (P) or T-leg (T)

CN	metallic champagne	+\$0
EH	metallic bronze	+\$0
MS	metallic silver	+\$0
SNA	satin aluminum	+\$30
SNB	satin bronze	+\$30
SNC	satin carbon	+\$30

Sand Texture Paint

For post leg (P) or T-leg (T)

BK	black	+\$0
-----------	-------	------

Smooth Paint

For post leg (P) or T-leg (T)

8Q	folkstone grey	+\$0
91	white	+\$0
98	studio white	+\$0
BU	black umber	+\$0
CL	cool grey neutral	+\$0
G2	graphite satin	+\$0
HF	inner tone light	+\$0
LU	soft white	+\$0
MT	medium tone	+\$0
SG	slate grey	+\$0
WL	sandstone	+\$0
WN	warm grey neutral	+\$0

For post leg (P) or T-leg (T)

CD	polished aluminum	+\$110
-----------	-------------------	--------

Metallic Paint

For T-leg with height adjustment (A)

CN	metallic champagne	+\$0
EH	metallic bronze	+\$0
MS	metallic silver	+\$0
SNA	satin aluminum	+\$30
SNB	satin bronze	+\$30
SNC	satin carbon	+\$30

Smooth Paint

For T-leg with height adjustment (A)

8Q	folkstone grey	+\$0
91	white	+\$0
98	studio white	+\$0
BU	black umber	+\$0
CL	cool grey neutral	+\$0
G2	graphite satin	+\$0
HF	inner tone light	+\$0
LU	soft white	+\$0
MT	medium tone	+\$0
SG	slate grey	+\$0
WL	sandstone	+\$0
WN	warm grey neutral	+\$0

For T-leg with height adjustment (A)

CD	polished aluminum	+\$110
-----------	-------------------	--------

Step 9. Casters/Glides

20	casters	+\$0
57	glides	+\$0

Soft Rectangle - Meeting Table

DT1FE.
DT1FS.
DT1FT.

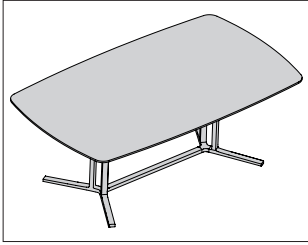

Product Information

Description

This rectangular table comes in multiple edge styles and has a laminate top with thermoplastic edge, veneer top and edge, or painted top and edge. It has multiple leg/base options, and is available with casters or glides. The caster option has 2 locking and 2 non-locking casters. Glides have 1/2" leveling range. Shipped knocked down.

Notes

When specifying grommets (253, 254, 255), cutouts will be located in the center of table.

Cutouts available for all Connect™ power and data accessories (see Thrive™ Portfolio). Cutouts will be located in the center, laterally and front to back.

For additional details on available edge options see Appendices.

For additional size, edge, and finish options, see Vary Easy Program in Appendices.

Dimensions

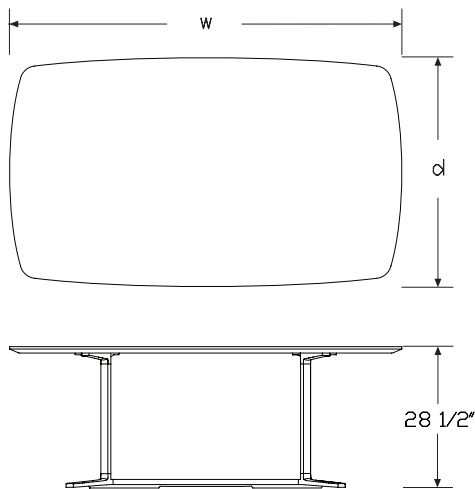

Specification Information

Step 1.

DT1F

Step 2. Edge

- S.** squared-edge
- T.** thin-edge
- E.** eased-edge

Step 3. Depth

- 30** 30" deep
- 36** 36" deep
- 42** 42" deep

Step 4. Width

For 30" deep (30)

- 48** 48" wide
- 60** 60" wide

For 36" deep (36)

- 60** 60" wide
- 72** 72" wide

For 42" deep (42)

- 72** 72" wide
- 84** 84" wide

Step 5. Surface Material

For squared-edge (S.)

- L** high-pressure laminate top/thermoplastic edge
- M** thermally-fused laminate top/thermoplastic edge
- W** veneer top/veneer edge A
- P** painted Formcoat® top/edge

For thin-edge (T.)

- W** veneer top/veneer edge A
- P** painted Formcoat® top/edge

For eased-edge (E.)

- P** painted Formcoat® top/edge

Soft Rectangle - Meeting Table

continued

Step 6. Leg/Base Type

For 48" wide (48) or 60" wide (60)

P	post leg
G	double 3-column base, spanner
T	T-leg
A	T-leg with height adjustment

For 72" wide (72) or 84" wide (84)

P	post leg
E	double 3-column base
G	double 3-column base, spanner

Prices for Steps 1-6.

	LP	LE	LG	LT	LA	MP
DT1FS. 30 48	\$1594	—	2626	2244	2800	1465
60	\$1722	—	2834	2453	3226	1582
36 60	\$1908	—	3147	2769	2826	1754
72	\$2197	3728	3618	—	—	2020
42 84	\$2417	4093	3976	—	—	2221
72	\$2350	3986	3870	—	—	2161

	ME	MG	MT	MA	WP	WE
DT1FS. 30 48	—	\$2413	2063	2574	2207	—
60	—	\$2606	2255	2966	2387	—
36 60	—	\$2893	2546	2597	2664	—
72	\$3427	3326	—	—	3077	5298
42 84	\$3763	3655	—	—	3394	5836
72	\$3664	3557	—	—	3298	5674

	WG	WT	WA	PP	PE	PG
DT1FS. 30 48	\$3699	3346	3332	1707	—	2814
60	\$4001	3649	3845	1845	—	3038
36 60	\$4457	4104	3451	2048	—	3378
72	\$5141	—	—	2356	3999	3883
42 84	\$5662	—	—	2593	4395	4267
72	\$5506	—	—	2522	4278	4154

	PT	PA
DT1FS. 30 48	\$2411	3009
60	\$2635	3464
36 60	\$2970	3034

	ME	MG	MT	MA	WP	WE
DT1FT. 30 48	—	—	—	—	\$2646	—
60	—	—	—	—	\$2867	—

36 60	—	—	—	—	\$3195	—
72	—	—	—	—	\$3691	6354
42 84	—	—	—	—	\$4074	7001
72	—	—	—	—	\$3960	6806

	WG	WT	WA	PP	PE	PG
DT1FT. 30 48	\$4436	4012	3999	1819	—	2999
60	\$4799	4377	4613	1964	—	3239
36 60	\$5346	4921	4140	2182	—	3594
72	\$6166	—	—	2512	4259	4134
42 84	\$6794	—	—	2760	4686	4546
72	\$6607	—	—	2685	4554	4425

	PT	PA
DT1FT. 30 48	\$3846	4801
60	\$4204	5527
36 60	\$4742	4847

	WG	WT	WA	PP	PE	PG
DT1FE. 30 48	—	—	—	\$1819	—	2999
60	—	—	—	\$1964	—	3239
36 60	—	—	—	\$2182	—	3594
72	—	—	—	\$2512	4259	4134
42 84	—	—	—	\$2760	4686	4546
72	—	—	—	\$2685	4554	4425

	PT	PA
DT1FE. 30 48	\$2567	3205
60	\$2806	3687
36 60	\$3163	3230

Everywhere™ Standard-Height Tables

Soft Rectangle - Meeting Table

continued

Everywhere™ Standard-Height Tables

Step 7.

Top Finish

For high-pressure laminate top/thermoplastic edge (L)

28	canyon	+\$0
29	misted	+\$0
38	twilight	+\$0
39	desert	+\$0
76	light brown walnut	+\$0
91	white	+\$0
98	studio white	+\$0
8Q	folkstone grey	+\$0
CL	cool grey neutral	+\$0
HF	inner tone light	+\$0
HM	natural maple	+\$0
HP	light anigre	+\$0
HX	aged cherry	+\$0
LBA	clear on ash	+\$0
LBR	phantom ecru	+\$0
LBS	phantom cocoa	+\$0
LBU	medium matte walnut	+\$0
LBV	warm grey teak	+\$0
LBB	oak on ash	+\$0
LBC	walnut on ash	+\$0
LBF	neutral twill	+\$0
LBJ	graphite twill	+\$0
LBQ	white twill	+\$0
LT	light tone	+\$0
LU	soft white	+\$0
WL	sandstone	+\$0
WN	warm grey neutral	+\$0
X1	chalk white	+\$0

Top Finish

For thermally-fused laminate top/thermoplastic edge (M)

8Q	folkstone grey	+\$0
91	white	+\$0
98	studio white	+\$0
HM	natural maple	+\$0
LBA	clear on ash	+\$0
LBB	oak on ash	+\$0
LBC	walnut on ash	+\$0
LBF	neutral twill	+\$0
LBQ	white twill	+\$0
LBU	medium matte walnut	+\$0

Top/Edge Finish

For veneer top/veneer edge (W)

2U	light brown walnut A	+\$85
40	dark brown walnut A	+\$85
CHD	noble cherry	+\$85
ET	clear on ash A	+\$85
EU	oak on ash A	+\$85
EV	walnut on ash A	+\$85
EW	medium matte walnut A	+\$85
UL	natural maple A	+\$85
WHN	natural white oak	+\$85

Top/Edge Finish: Opaque Formcoat®

For painted Formcoat® top/edge (P)

8Q	folkstone grey	+\$0
91	white	+\$0
LU	soft white	+\$0

Step 8. Edge Finish

For high-pressure laminate top/thermoplastic edge (L) or thermally-fused laminate top/thermoplastic edge (M)

76	light brown walnut	+\$0
8Q	folkstone grey	+\$0
91	white	+\$0
98	studio white	+\$0
CL	cool grey neutral	+\$0
LBA	clear on ash	+\$0
LBR	phantom ecru	+\$0
LBS	phantom cocoa	+\$0
LBU	medium matte walnut	+\$0
LBV	warm grey teak	+\$0
LBB	oak on ash	+\$0
LBC	walnut on ash	+\$0
LBF	neutral twill	+\$0
LBJ	graphite twill	+\$0
LBQ	white twill	+\$0
WL	sandstone	+\$0
WN	warm grey neutral	+\$0
HF	inner tone light	+\$0
HM	natural maple	+\$0
HP	light anigre	+\$0
HX	aged cherry	+\$0
LU	soft white	+\$0
X1	chalk white	+\$0

Soft Rectangle - Meeting Table

continued

Step 9. Leg/Base Finish

Metallic Paint

For post leg (P), double 3-column base (E), double 3-column base, spanner (G), or T-leg (T)

CN	metallic champagne	+\$0
EH	metallic bronze	+\$0
MS	metallic silver	+\$0
SNA	satin aluminum	+\$30
SNB	satin bronze	+\$30
SNC	satin carbon	+\$30

Sand Texture Paint

For post leg (P), double 3-column base (E), double 3-column base, spanner (G), or T-leg (T)

BK	black	+\$0
-----------	-------	------

Smooth Paint

For post leg (P), double 3-column base (E), double 3-column base, spanner (G), or T-leg (T)

8Q	folkstone grey	+\$0
91	white	+\$0
98	studio white	+\$0
BU	black umber	+\$0
CL	cool grey neutral	+\$0
G2	graphite satin	+\$0
HF	inner tone light	+\$0
LU	soft white	+\$0
MT	medium tone	+\$0
SG	slate grey	+\$0
WL	sandstone	+\$0
WN	warm grey neutral	+\$0

For post leg (P), double 3-column base (E), double 3-column base, spanner (G), or T-leg (T)

CD	polished aluminum	+\$110
-----------	-------------------	--------

Metallic Paint

For T-leg with height adjustment (A)

CN	metallic champagne	+\$0
EH	metallic bronze	+\$0
MS	metallic silver	+\$0
SNA	satin aluminum	+\$30
SNB	satin bronze	+\$30
SNC	satin carbon	+\$30

Smooth Paint

For T-leg with height adjustment (A)

8Q	folkstone grey	+\$0
91	white	+\$0
98	studio white	+\$0
BU	black umber	+\$0
CL	cool grey neutral	+\$0
G2	graphite satin	+\$0
HF	inner tone light	+\$0
LU	soft white	+\$0
MT	medium tone	+\$0
SG	slate grey	+\$0
WL	sandstone	+\$0
WN	warm grey neutral	+\$0

For T-leg with height adjustment (A)

CD	polished aluminum	+\$110
-----------	-------------------	--------

Step 10. Casters/Glides

20	casters	+\$0
57	glides	+\$0

Step 11. Grommets

NTG	no grommet	+\$0
253	cutout for Y1420. or Y1425. - 3 port	+\$27
254	cutout for Y1420. or Y1425. - 5 port	+\$27
255	cutout for Y1420. or Y1425. - 6 port	+\$27

Video Oval - Meeting Table

DT1GE.
DT1GS.
DT1GT.

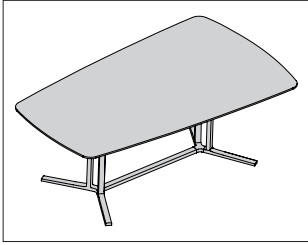

Everywhere™ Standard-Height Tables

Product Information

Description
This oval table comes in multiple edge styles and has a laminate top with thermoplastic edge, veneer top and edge, or painted top and edge. It has multiple leg/base options, and is available with casters or glides. The caster option has 2 locking and 2 non-locking casters. Glides have 1/2" leveling range. Shipped knocked down.

Notes

When specifying grommets (253, 254, 255), cutouts will be located in the center of table.
Cutouts available for all Connect™ power and data accessories (see Thrive™ Portfolio). Cutouts will be located in the center, laterally and front to back.
For optimum viewing, video camera should be placed 42" from large end of table.
For additional details on available edge options see Appendices.
For additional size, edge, and finish options, see Vary Easy Program in Appendices.

Dimensions

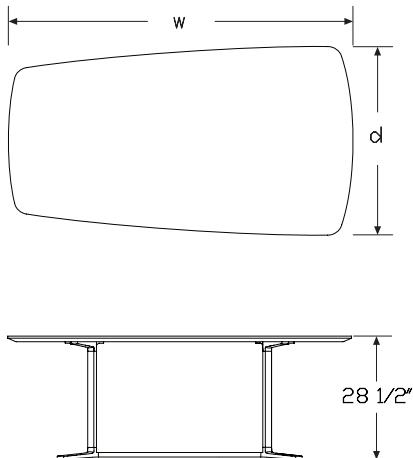

Specification Information

Step 1.

DT1G

Step 2. Edge

- S.** squared-edge
- T.** thin-edge
- E.** eased-edge

Step 3. Depth

42 42" deep

Step 4. Width

72 72" wide
84 84" wide

Step 5. Surface Material

For squared-edge (S.)

- L** high-pressure laminate top/thermoplastic edge
- M** thermally-fused laminate top/thermoplastic edge
- W** veneer top/veneer edge A
- P** painted Formcoat® top/edge

For thin-edge (T.)

- W** veneer top/veneer edge A
- P** painted Formcoat® top/edge

For eased-edge (E.)

- P** painted Formcoat® top/edge

Step 6. Leg/Base Type

- E** double 3-column base
- G** double 3-column base, spanner

Prices for Steps 1-6.

	LE	LG	ME	MG	WE	WG	PE	PG
DT1GS. 42 72	\$4053	3935	3687	3579	5722	5552		
84	\$4162	4043	3786	3678	5884	5710		
DT1GS. 42 72					\$4313	4189		
84					\$4432	4303		
DT1GT. 42 72	—	—	—	—	\$6863	6662		
84	—	—	—	—	\$7060	6851		

Video Oval - Meeting Table

continued

	PE	PG
DT1GT. 42 72	\$5283	5131
84	\$5428	5270
	PE	PG
DT1GE. 42 72	\$4592	4462
84	\$4726	4584

Step 7.

Top Finish

For high-pressure laminate top/thermoplastic edge (L)

28	canyon	+\$0
29	misted	+\$0
38	twilight	+\$0
39	desert	+\$0
76	light brown walnut	+\$0
91	white	+\$0
98	studio white	+\$0
8Q	folkstone grey	+\$0
CL	cool grey neutral	+\$0
HF	inner tone light	+\$0
HM	natural maple	+\$0
HP	light anigre	+\$0
HX	aged cherry	+\$0
LBA	clear on ash	+\$0
LBR	phantom ecru	+\$0
LBS	phantom cocoa	+\$0
LBU	medium matte walnut	+\$0
LBV	warm grey teak	+\$0
LBB	oak on ash	+\$0
LBC	walnut on ash	+\$0
LBF	neutral twill	+\$0
LBJ	graphite twill	+\$0
LBQ	white twill	+\$0
LT	light tone	+\$0
LU	soft white	+\$0
WL	sandstone	+\$0
WN	warm grey neutral	+\$0
X1	chalk white	+\$0

Top Finish

For thermally-fused laminate top/thermoplastic edge (M)

8Q	folkstone grey	+\$0
91	white	+\$0
98	studio white	+\$0
HM	natural maple	+\$0
LBA	clear on ash	+\$0
LBB	oak on ash	+\$0
LBC	walnut on ash	+\$0
LBF	neutral twill	+\$0
LBQ	white twill	+\$0
LBU	medium matte walnut	+\$0

Top/Edge Finish

For veneer top/veneer edge (W)

2U	light brown walnut <input type="checkbox"/> A	+\$85
40	dark brown walnut <input type="checkbox"/> A	+\$85
CHD	noble cherry	+\$85
ET	clear on ash <input type="checkbox"/> A	+\$85
EU	oak on ash <input type="checkbox"/> A	+\$85
EV	walnut on ash <input type="checkbox"/> A	+\$85
EW	medium matte walnut <input type="checkbox"/> A	+\$85
UL	natural maple <input type="checkbox"/> A	+\$85
WHN	natural white oak	+\$85

Top/Edge Finish: Opaque Formcoat®

For painted Formcoat® top/edge (P)

8Q	folkstone grey	+\$0
91	white	+\$0
LU	soft white	+\$0

Video Oval - Meeting Table

continued

Everywhere™ Standard-Height Tables

Step 8. Edge Finish

For high-pressure laminate top/thermoplastic edge (L) or thermally-fused laminate top/thermoplastic edge (M)

76	light brown walnut	+\$0
8Q	folkstone grey	+\$0
91	white	+\$0
98	studio white	+\$0
CL	cool grey neutral	+\$0
LBA	clear on ash	+\$0
LBR	phantom ecru	+\$0
LBS	phantom cocoa	+\$0
LBU	medium matte walnut	+\$0
LBV	warm grey teak	+\$0
LBB	oak on ash	+\$0
LBC	walnut on ash	+\$0
LBF	neutral twill	+\$0
LBJ	graphite twill	+\$0
LBQ	white twill	+\$0
WL	sandstone	+\$0
WN	warm grey neutral	+\$0
HF	inner tone light	+\$0
HM	natural maple	+\$0
HP	light anigre	+\$0
HX	aged cherry	+\$0
LU	soft white	+\$0

Step 9. Leg/Base Finish

Metallic Paint

CN	metallic champagne	+\$0
EH	metallic bronze	+\$0
MS	metallic silver	+\$0
SNA	satin aluminum	+\$30
SNB	satin bronze	+\$30
SNC	satin carbon	+\$30

Sand Texture Paint

BK	black	+\$0
-----------	-------	------

Smooth Paint

8Q	folkstone grey	+\$0
91	white	+\$0
98	studio white	+\$0
BU	black umber	+\$0
CL	cool grey neutral	+\$0
G2	graphite satin	+\$0
HF	inner tone light	+\$0
LU	soft white	+\$0
MT	medium tone	+\$0
SG	slate grey	+\$0
WL	sandstone	+\$0
WN	warm grey neutral	+\$0
CD	polished aluminum	+\$110

Step 10. Casters/Glides

20	casters	+\$0
57	glides	+\$0

Step 11. Grommets

NTG	no grommet	+\$0
253	cutout for Y1420. or Y1425. - 3 port	+\$27
254	cutout for Y1420. or Y1425. - 5 port	+\$27
255	cutout for Y1420. or Y1425. - 6 port	+\$27

Concave Rectangle

DT1HE.
DT1HS.
DT1HT.

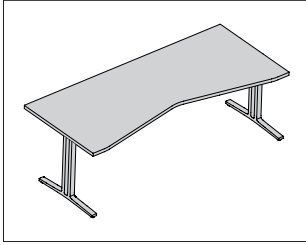

Product Information

Description

This rectangular table comes in multiple edge styles and has a laminate top with thermoplastic edge, veneer top and edge, or painted top and edge. It has multiple leg options, and is available with casters or glides. The caster option has 2 locking and 2 non-locking casters. Glides have 1/2" leveling range. Shipped knocked down.

Height-adjustable legs have a 5" range in 1" increments.

Notes

When specifying grommets (253, 254, 255), cutouts will be located in the center of table.

Cutouts available for all Connect™ power and data accessories (see Thrive™ Portfolio). Cutouts will be located in the center, laterally, and approximately 3" from the rear edge of surface.

Reinforcement channels are used under table tops 54" and wider. They will be located along the center line for 18" deep and 24" deep surfaces, and 19" from the front edge for 30" deep surfaces.

For additional details on available edge options see Appendices. For additional size, edge, finish, and cable management options, see Vary Easy Program in Appendices.

UL listed when used with Connect single circuit electrical product (Y137x.) with post leg (P), T-leg (T) and C-leg (C) options.

Dimensions

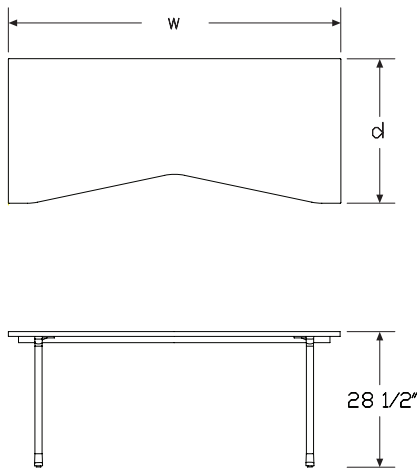

Specification Information

Step 1.

DT1H

Step 2. Edge

- S.** squared-edge
- T.** thin-edge
- E.** eased-edge

Step 3. Depth

- 30** 30" deep
- 36** 36" deep

Step 4. Width

- 60** 60" wide
- 66** 66" wide
- 72** 72" wide

Step 5. Surface Material

For squared-edge (S.)

- L** high-pressure laminate top/thermoplastic edge
- M** thermally-fused laminate top/thermoplastic edge
- W** veneer top/veneer edge **A**
- P** painted Formcoat® top/edge

For thin-edge (T.)

- W** veneer top/veneer edge **A**
- P** painted Formcoat® top/edge

For eased-edge (E.)

- P** painted Formcoat® top/edge

Step 6. Leg Type

For 30" deep (30)

- P** post leg
- T** T-leg
- A** T-leg with height adjustment
- C** C-leg
- D** D-leg

For 36" deep (36)

- P** post leg
- T** T-leg
- A** T-leg with height adjustment

Concave Rectangle *continued*

Everywhere™ Standard-Height Tables

Prices for Steps 1-6.

	LP	LT	LA	LC	LD	MP
DT1HS. 30 60	\$1854	2408	3003	2408	3003	1702
66	\$1988	2580	3222	2580	3222	1825
72	\$2119	2754	3438	2754	3438	1945

36 60	\$1967	2494	3029	—	—	1806
66	\$2069	2628	3313	—	—	1900
72	\$2173	2764	3597	—	—	1995

	MT	MA	MC	MD	WP	WT
DT1HS. 30 60	\$2211	2757	2211	2757	2136	2808
66	\$2369	2958	2369	2958	2299	3018
72	\$2529	3157	2529	3157	2462	3226

36 60	\$2290	2781	—	—	2217	2886
66	\$2413	3042	—	—	2378	3097
72	\$2538	3303	—	—	2538	3303

	WA	WC	WD	PP	PT	PA
DT1HS. 30 60	\$3534	2808	3534	1989	2580	3222
66	\$3797	3018	3797	2129	2765	3456
72	\$4059	3226	4059	2272	2952	3687

36 60	\$3614	—	—	2109	2672	3250
66	\$3878	—	—	2219	2819	3552
72	\$4142	—	—	2331	2962	3859

	PC	PD
DT1HS. 30 60	\$2580	3222
66	\$2765	3456
72	\$2952	3687

	MT	MA	MC	MD	WP	WT
DT1HT. 30 60	—	—	—	—	\$2561	3364
66	—	—	—	—	\$2755	3616
72	—	—	—	—	\$2952	3870

36 60	—	—	—	—	\$2658	3461
66	—	—	—	—	\$2853	3715
72	—	—	—	—	\$3049	3968

	WA	WC	WD	PP	PT	PA
DT1HT. 30 60	\$4242	3364	4242	2118	2747	3434
66	\$4557	3616	4557	2269	2945	3678
72	\$4871	3870	4871	2420	3143	3926

36 60	\$4339	—	—	2243	2849	3460
66	\$4650	—	—	2365	3001	3784
72	\$4966	—	—	2480	3155	4108

	PC	PD
DT1HT. 30 60	\$2747	3434
66	\$2945	3678
72	\$3143	3926

	WA	WC	WD	PP	PT	PA
DT1HE. 30 60	—	—	—	\$2118	2747	3434
66	—	—	—	\$2269	2945	3678
72	—	—	—	\$2420	3143	3926

36 60	—	—	—	\$2243	2849	3460
66	—	—	—	\$2365	3001	3784
72	—	—	—	\$2480	3155	4108

	PC	PD
DT1HE. 30 60	\$2747	3434
66	\$2945	3678
72	\$3143	3926

Concave Rectangle *continued*

Step 7.

Top Finish		
<i>For high-pressure laminate top/thermoplastic edge (L)</i>		
28	canyon	+\$0
29	misted	+\$0
38	twilight	+\$0
39	desert	+\$0
76	light brown walnut	+\$0
91	white	+\$0
98	studio white	+\$0
8Q	folkstone grey	+\$0
CL	cool grey neutral	+\$0
HF	inner tone light	+\$0
HM	natural maple	+\$0
HP	light anigre	+\$0
HX	aged cherry	+\$0
LBA	clear on ash	+\$0
LBR	phantom ecru	+\$0
LBS	phantom cocoa	+\$0
LBU	medium matte walnut	+\$0
LBV	warm grey teak	+\$0
LBB	oak on ash	+\$0
LBC	walnut on ash	+\$0
LBF	neutral twill	+\$0
LBJ	graphite twill	+\$0
LBQ	white twill	+\$0
LT	light tone	+\$0
LU	soft white	+\$0
WL	sandstone	+\$0
WN	warm grey neutral	+\$0
X1	chalk white	+\$0

Top Finish		
<i>For thermally-fused laminate top/thermoplastic edge (M)</i>		
8Q	folkstone grey	+\$0
91	white	+\$0
98	studio white	+\$0
HM	natural maple	+\$0
LBA	clear on ash	+\$0
LBB	oak on ash	+\$0
LBC	walnut on ash	+\$0
LBF	neutral twill	+\$0
LBQ	white twill	+\$0
LBU	medium matte walnut	+\$0

Top/Edge Finish: Wood Veneer		
<i>For veneer top/veneer edge (W)</i>		
2U	light brown walnut A	+\$85
40	dark brown walnut A	+\$85
CHD	noble cherry	+\$85
ET	clear on ash	+\$85
EU	oak on ash	+\$85
EV	walnut on ash	+\$85
EW	medium matte walnut A	+\$85
UL	natural maple A	+\$85
WHN	natural white oak	+\$85

Top/Edge Finish: Opaque Formcoat®		
<i>For painted Formcoat® top/edge (P)</i>		
8Q	folkstone grey	+\$0
91	white	+\$0
LU	soft white	+\$0

Step 8. Edge Finish		
<i>For high-pressure laminate top/thermoplastic edge (L) or thermally-fused laminate top/thermoplastic edge (M)</i>		
76	light brown walnut	+\$0
8Q	folkstone grey	+\$0
91	white	+\$0
98	studio white	+\$0
CL	cool grey neutral	+\$0
LBA	clear on ash	+\$0
LBR	phantom ecru	+\$0
LBS	phantom cocoa	+\$0
LBU	medium matte walnut	+\$0
LBV	warm grey teak	+\$0
LBB	oak on ash	+\$0
LBC	walnut on ash	+\$0
LBF	neutral twill	+\$0
LBJ	graphite twill	+\$0
LBQ	white twill	+\$0
WL	sandstone	+\$0
WN	warm grey neutral	+\$0
HF	inner tone light	+\$0
HM	natural maple	+\$0
HP	light anigre	+\$0
HX	aged cherry	+\$0
LU	soft white	+\$0

Concave Rectangle *continued*

Step 9. Leg Finish

Metallic Paint

For post leg (P), T-leg (T), C-leg (C), or D-leg (D)

CN	metallic champagne	+\$0
EH	metallic bronze	+\$0
MS	metallic silver	+\$0
SNA	satin aluminum	+\$30
SNB	satin bronze	+\$30
SNC	satin carbon	+\$30

Sand Texture Paint

For post leg (P), T-leg (T), C-leg (C), or D-leg (D)

BK	black	+\$0
-----------	-------	------

Smooth Paint

For post leg (P), T-leg (T), C-leg (C), or D-leg (D)

8Q	folkstone grey	+\$0
91	white	+\$0
98	studio white	+\$0
BU	black umber	+\$0
CL	cool grey neutral	+\$0
G2	graphite satin	+\$0
HF	inner tone light	+\$0
LU	soft white	+\$0
MT	medium tone	+\$0
SG	slate grey	+\$0
WL	sandstone	+\$0
WN	warm grey neutral	+\$0

For post leg (P), T-leg (T), C-leg (C), or D-leg (D)

CD	polished aluminum	+\$110
-----------	-------------------	--------

Metallic Paint

For T-leg with height adjustment (A)

CN	metallic champagne	+\$0
EH	metallic bronze	+\$0
MS	metallic silver	+\$0
SNA	satin aluminum	+\$30
SNB	satin bronze	+\$30
SNC	satin carbon	+\$30

Smooth Paint

For T-leg with height adjustment (A)

8Q	folkstone grey	+\$0
91	white	+\$0
98	studio white	+\$0
BU	black umber	+\$0
CL	cool grey neutral	+\$0
G2	graphite satin	+\$0
HF	inner tone light	+\$0
LU	soft white	+\$0
MT	medium tone	+\$0
SG	slate grey	+\$0
WL	sandstone	+\$0
WN	warm grey neutral	+\$0

For T-leg with height adjustment (A)

CD	polished aluminum	+\$110
-----------	-------------------	--------

Step 10. Casters/Glides

20	casters	+\$0
57	glides	+\$0

Step 11. Grommets

NTG	no grommet	+\$0
253	cutout for Y1420. or Y1425. - 3 port	+\$27
254	cutout for Y1420. or Y1425. - 5 port	+\$27
255	cutout for Y1420. or Y1425. - 6 port	+\$27

Soft Square Table

DT1JE.
DT1JS.
DT1JT.

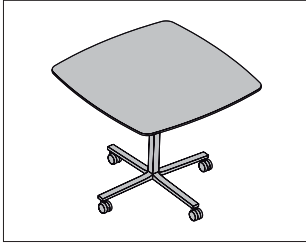

Product Information

Description

This square table comes in multiple edge styles and has a laminate top with thermoplastic edge, veneer top and edge, or painted top and edge. It has multiple leg/base options, and is available with casters or glides. The caster option has 2 locking and 2 non-locking casters. Glides have 1/2" leveling range. Shipped knocked down.

Notes

42" and 48" tops are available only with post legs for optimum stability.

For additional details on available edge options see Appendices.

For additional size, edge, and finish options, see Vary Easy Program in Appendices.

UL listed when used with Connect™ single circuit electrical product (Y137x.) with post leg (P) option.

Dimensions

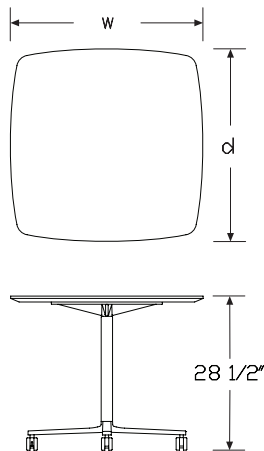

Specification Information

Step 1.

DT1J

Step 2. Edge

- S.** squared-edge
- T.** thin-edge
- E.** eased-edge

Step 3. Depth/Width

- 3030** 30" deep x 30" wide
- 3636** 36" deep x 36" wide
- 4242** 42" deep x 42" wide
- 4848** 48" deep x 48" wide

Step 4. Surface Material

For squared-edge (S.)

- L** high-pressure laminate top/thermoplastic edge
- M** thermally-fused laminate top/thermoplastic edge
- W** veneer top/veneer edge A
- P** painted Formcoat® top/edge

For thin-edge (T.)

- W** veneer top/veneer edge A
- P** painted Formcoat® top/edge

For eased-edge (E.)

- P** painted Formcoat® top/edge

Step 5. Leg/Base Type

For 30" deep x 30" wide (3030) or 36" deep x 36" wide (3636)

- P** post leg
- S** single-column base A

For 42" deep x 42" wide (4242)

- P** post leg

For 48" deep x 48" wide (4848)

- P** post leg

Soft Square Table *continued*

Everywhere™ Standard-Height Tables

Prices for Steps 1-5.			
		P	S
DT1JS.	3030 L	\$1214	1339
	M	\$1117	1232
	W	\$1435	1592
	P	\$1302	1439
	3636 L	\$1457	1605
	M	\$1340	1478
	W	\$1738	1928
	P	\$1562	1724
	4242 L	\$1670	—
	M	\$1536	—
	W	\$2010	—
	P	\$1796	—
	4848 L	\$1872	—
	M	\$1723	—
	W	\$2356	—
	P	\$2010	—
		P	S
DT1JT.	3030 W	\$1719	1906
	P	\$1390	1535
	3636 W	\$2083	2315
	P	\$1666	1837
	4242 W	\$2411	—
	P	\$1909	—
	4848 W	\$2824	—
	P	\$2140	—
		P	S
DT1JE.	3030 P	\$1390	1535
	3636 P	\$1666	1837
	4242 P	\$1909	—
	4848 P	\$2140	—

Step 6.		
Top Finish		
<i>For high-pressure laminate top/thermoplastic edge (L)</i>		
28	canyon	+\$0
29	misted	+\$0
38	twilight	+\$0
39	desert	+\$0
76	light brown walnut	+\$0
91	white	+\$0
98	studio white	+\$0
8Q	folkstone grey	+\$0
CL	cool grey neutral	+\$0
HF	inner tone light	+\$0
HM	natural maple	+\$0
HP	light anigre	+\$0
HX	aged cherry	+\$0
LBA	clear on ash	+\$0
LBR	phantom ecru	+\$0
LBS	phantom cocoa	+\$0
LBU	medium matte walnut	+\$0
LBV	warm grey teak	+\$0
LBB	oak on ash	+\$0
LBC	walnut on ash	+\$0
LBF	neutral twill	+\$0
LBJ	graphite twill	+\$0
LBQ	white twill	+\$0
LT	light tone	+\$0
LU	soft white	+\$0
WL	sandstone	+\$0
WN	warm grey neutral	+\$0
X1	chalk white	+\$0

Top Finish		
<i>For thermally-fused laminate top/thermoplastic edge (M)</i>		
8Q	folkstone grey	+\$0
91	white	+\$0
98	studio white	+\$0
HM	natural maple	+\$0
LBA	clear on ash	+\$0
LBB	oak on ash	+\$0
LBC	walnut on ash	+\$0
LBF	neutral twill	+\$0
LBQ	white twill	+\$0
LBU	medium matte walnut	+\$0

Top/Edge Finish: Wood Veneer

For veneer top/veneer edge (W)

2U	light brown walnut	+\$85
40	dark brown walnut	+\$85
CHD	noble cherry	+\$85
ET	clear on ash	+\$85
EU	oak on ash	+\$85
EV	walnut on ash	+\$85
EW	medium matte walnut	+\$85
UL	natural maple	+\$85
WHN	natural white oak	+\$85

Top/Edge Finish: Opaque Formcoat®

For painted Formcoat® top/edge (P)

8Q	folkstone grey	+\$0
91	white	+\$0
LU	soft white	+\$0

Step 7. Edge Finish

For high-pressure laminate top/thermoplastic edge (L) or thermally-fused laminate top/thermoplastic edge (M)

76	light brown walnut	+\$0
8Q	folkstone grey	+\$0
91	white	+\$0
98	studio white	+\$0
CL	cool grey neutral	+\$0
LBA	clear on ash	+\$0
LBR	phantom ecru	+\$0
LBS	phantom cocoa	+\$0
LBU	medium matte walnut	+\$0
LBV	warm grey teak	+\$0
LBB	oak on ash	+\$0
LBC	walnut on ash	+\$0
LBF	neutral twill	+\$0
LBJ	graphite twill	+\$0
LBQ	white twill	+\$0
WL	sandstone	+\$0
WN	warm grey neutral	+\$0
HF	inner tone light	+\$0
HM	natural maple	+\$0
HP	light anigre	+\$0
HX	aged cherry	+\$0
LU	soft white	+\$0

Step 8. Leg Finish

Metallic Paint

CN	metallic champagne	+\$0
EH	metallic bronze	+\$0
MS	metallic silver	+\$0
SNA	satin aluminum	+\$30
SNB	satin bronze	+\$30
SNC	satin carbon	+\$30

Sand Texture Paint

BK	black	+\$0
-----------	-------	------

Smooth Paint

8Q	folkstone grey	+\$0
91	white	+\$0
98	studio white	+\$0
BU	black umber	+\$0
CL	cool grey neutral	+\$0
G2	graphite satin	+\$0
HF	inner tone light	+\$0
LU	soft white	+\$0
MT	medium tone	+\$0
SG	slate grey	+\$0
WL	sandstone	+\$0
WN	warm grey neutral	+\$0
CD	polished aluminum	+\$110

Step 9. Casters/Glides

20	casters	+\$0
57	glides	+\$0

Tear Drop Table

DT1KE.
DT1KS.
DT1KT.

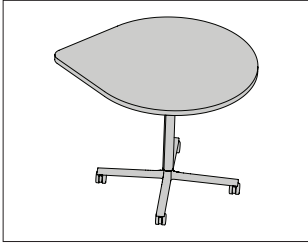

Everywhere™ Standard-Height Tables

Product Information

Description

This tear drop table comes in multiple edge styles and has a laminate top with thermoplastic edge, veneer top and edge, or painted top and edge. It has multiple leg/base options, and is available with casters or glides. The caster option has 2 locking and 2 non-locking casters. Glides have 1/2" leveling range. Shipped knocked down.

Notes

For additional details on available edge options see Appendices.
For additional size, edge, and finish options, see Vary Easy Program in Appendices.

Dimensions

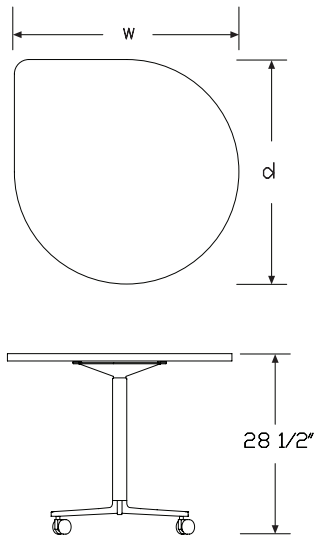

Specification Information

Step 1.

DT1K A

Step 2. Edge

- S.** squared-edge
- T.** thin-edge
- E.** eased-edge

Step 3. Diameter

- 30** 30" diameter
- 36** 36" diameter

Step 4. Surface Material

For eased-edge (E.)

- P** painted Formcoat® top/edge

For thin-edge (T.)

- W** veneer top/veneer edge
- P** painted Formcoat® top/edge

For squared-edge (S.)

- L** high-pressure laminate top/thermoplastic edge
- M** thermally-fused laminate top/thermoplastic edge
- W** veneer top/veneer edge
- P** painted Formcoat® top/edge

Step 5. Leg/Base Type

- S** single-column base A

Prices for Steps 1-5.

	S
DT1KS. 30 L	\$1403
M	\$1294
W	\$1661
P	\$1506
36 L	\$1604
M	\$1479
W	\$2018
P	\$1726
	S
DT1KT. 30 W	\$1999
P	\$1604
36 W	\$2419
P	\$1839

Tear Drop Table *continued*

	S
DT1KE. 30 P	\$1604
36 P	\$1839

Step 6.

Top Finish

For high-pressure laminate top/thermoplastic edge (L)

28	canyon	+\$0
29	misted	+\$0
38	twilight	+\$0
39	desert	+\$0
76	light brown walnut	+\$0
91	white	+\$0
98	studio white	+\$0
8Q	folkstone grey	+\$0
CL	cool grey neutral	+\$0
HF	inner tone light	+\$0
HM	natural maple	+\$0
HP	light anigre	+\$0
HX	aged cherry	+\$0
LBA	clear on ash	+\$0
LBR	phantom ecru	+\$0
LBS	phantom cocoa	+\$0
LBU	medium matte walnut	+\$0
LBV	warm grey teak	+\$0
LBB	oak on ash	+\$0
LBC	walnut on ash	+\$0
LBF	neutral twill	+\$0
LBJ	graphite twill	+\$0
LBQ	white twill	+\$0
LT	light tone	+\$0
LU	soft white	+\$0
WL	sandstone	+\$0
WN	warm grey neutral	+\$0
X1	chalk white	+\$0

Top Finish

For thermally-fused laminate top/thermoplastic edge (M)

8Q	folkstone grey	+\$0
91	white	+\$0
98	studio white	+\$0
HM	natural maple	+\$0
LBA	clear on ash	+\$0
LBB	oak on ash	+\$0
LBC	walnut on ash	+\$0
LBF	neutral twill	+\$0
LBQ	white twill	+\$0
LBU	medium matte walnut	+\$0

Top/Edge Finish: Opaque Formcoat®

For painted Formcoat® top/edge (P)

8Q	folkstone grey	+\$0
91	white	+\$0
LU	soft white	+\$0

Top/Edge Finish: Wood Veneer

For veneer top/veneer edge (W)

2U	light brown walnut A	+\$85
40	dark brown walnut A	+\$85
CHD	noble cherry	+\$85
ET	clear on ash	+\$85
EU	oak on ash	+\$85
EV	walnut on ash	+\$85
EW	medium matte walnut A	+\$85
UL	natural maple A	+\$85
WHN	natural white oak	+\$85

Tear Drop Table *continued*

Everywhere™ Standard-Height Tables

Step 7. Edge Finish

For high-pressure laminate top/thermoplastic edge (L) or thermally-fused laminate top/thermoplastic edge (M)

76	light brown walnut	+\$0
8Q	folkstone grey	+\$0
91	white	+\$0
98	studio white	+\$0
CL	cool grey neutral	+\$0
LBA	clear on ash	+\$0
LBR	phantom ecru	+\$0
LBS	phantom cocoa	+\$0
LBU	medium matte walnut	+\$0
LBV	warm grey teak	+\$0
LBB	oak on ash	+\$0
LBC	walnut on ash	+\$0
LBF	neutral twill	+\$0
LBJ	graphite twill	+\$0
LBQ	white twill	+\$0
WL	sandstone	+\$0
WN	warm grey neutral	+\$0
HF	inner tone light	+\$0
HM	natural maple	+\$0
HP	light anigre	+\$0
HX	aged cherry	+\$0
LU	soft white	+\$0

Step 8. Leg/Base Finish

Metallic Paint

CN	metallic champagne	+\$0
EH	metallic bronze	+\$0
MS	metallic silver	+\$0
SNA	satin aluminum	+\$30
SNB	satin bronze	+\$30
SNC	satin carbon	+\$30

Sand Texture Paint

BK	black	+\$0
-----------	-------	------

Smooth Paint

8Q	folkstone grey	+\$0
91	white	+\$0
98	studio white	+\$0
BU	black umber	+\$0
CL	cool grey neutral	+\$0
G2	graphite satin	+\$0
HF	inner tone light	+\$0
LU	soft white	+\$0
MT	medium tone	+\$0
SG	slate grey	+\$0
WL	sandstone	+\$0
WN	warm grey neutral	+\$0
CD	polished aluminum	+\$110

Step 9. Casters/Glides

20	casters	+\$0
57	glides	+\$0

Classroom Curve Table

DT1LE.
DT1LS.
DT1LT.

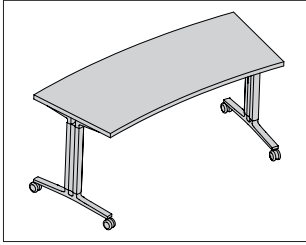

Product Information

Description

This classroom table comes in multiple edge styles and has a laminate top with thermoplastic edge, veneer top and edge, or painted top and edge. It has multiple leg options, and is available with casters or glides. The caster option has 2 locking and 2 non-locking casters. Glides have 1/2" leveling range. Shipped knocked down.

Height-adjustable legs have a 5" range in 1" increments.

Notes

Cable grommet options available through Vary Easy Program for round pass through grommet with 2 1/4" hole clearance. Holes are located 3" from rear edge and 6" from end for the L and R options. Covers not provided with painted surface option.

Reinforcement channels are used under table tops 54" and wider.

They will be located along the center line for 18" deep and 24" deep surfaces, and 19" from the front edge for 30" deep surfaces.

For additional details on available edge options see Appendices.

For additional size, edge, finish, and cable management options, see Vary Easy Program in Appendices.

UL listed when used with Connect™ single circuit electrical product (Y137x.) with post leg (P) and T-leg (T) options.

Dimensions

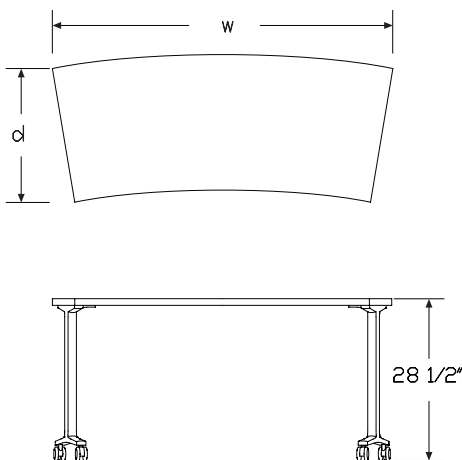

Specification Information

Step 1.

DT1L

Step 2. Edge

- S.** squared-edge
- T.** thin-edge
- E.** eased-edge

Step 3. Depth

For squared-edge (S.)

- 18** 18" deep
- 24** 24" deep

For thin-edge (T.)

- 24** 24" deep

For eased-edge (E.)

- 24** 24" deep

Step 4. Width

For 18" deep (18)

- 60** 60" wide

For 24" deep (24)

- 48** 48" wide
- 60** 60" wide

Step 5. Surface Material

For squared-edge (S.)

- L** high-pressure laminate top/thermoplastic edge
- M** thermally-fused laminate top/thermoplastic edge
- W** veneer top/veneer edge **A**
- P** painted Formcoat® top/edge

For thin-edge (T.)

- W** veneer top/veneer edge **A**
- P** painted Formcoat® top/edge

For eased-edge (E.)

- P** painted Formcoat® top/edge

Classroom Curve Table *continued*

Everywhere™ Standard-Height Tables

Step 6. Leg Type

For 18" deep (18)

P post leg

For 24" deep (24)

P post leg

T T-leg

A T-leg with height adjustment

Prices for Steps 1-6.

	LP	LT	LA	MP	MT	MA
DT1LS. 18 60	\$1577	—	—	1454	—	—
24 48	\$1578	2050	2566	1455	1891	2367
60	\$1773	2306	2878	1636	2127	2655

	WP	WT	WA	PP	PT	PA
DT1LS. 18 60	\$1810	—	—	1699	—	—
24 48	\$1812	2387	3008	1700	2209	2759
60	\$2052	2694	3396	1911	2480	3097

	WP	WT	WA	PP	PT	PA
DT1LT. 24 48	\$2176	2866	3608	1809	2352	2939
60	\$2460	3231	4074	2035	2643	3298

	WP	WT	WA	PP	PT	PA
DT1LE. 24 48	—	—	—	\$1809	2352	2939
60	—	—	—	\$2035	2643	3298

Step 7.

Top Finish

For high-pressure laminate top/thermoplastic edge (L)

28	canyon	+\$0
29	misted	+\$0
38	twilight	+\$0
39	desert	+\$0
76	light brown walnut	+\$0
91	white	+\$0
98	studio white	+\$0
8Q	folkstone grey	+\$0
CL	cool grey neutral	+\$0
HF	inner tone light	+\$0
HM	natural maple	+\$0
HP	light anigre	+\$0
HX	aged cherry	+\$0
LBA	clear on ash	+\$0
LBR	phantom ecru	+\$0
LBS	phantom cocoa	+\$0
LBU	medium matte walnut	+\$0
LBV	warm grey teak	+\$0
LBB	oak on ash	+\$0
LBC	walnut on ash	+\$0
LBF	neutral twill	+\$0
LBJ	graphite twill	+\$0
LBQ	white twill	+\$0
LT	light tone	+\$0
LU	soft white	+\$0
WL	sandstone	+\$0
WN	warm grey neutral	+\$0
X1	chalk white	+\$0

Top Finish

For thermally-fused laminate top/thermoplastic edge (M)

8Q	folkstone grey	+\$0
91	white	+\$0
98	studio white	+\$0
HM	natural maple	+\$0
LBA	clear on ash	+\$0
LBB	oak on ash	+\$0
LBC	walnut on ash	+\$0
LBF	neutral twill	+\$0
LBQ	white twill	+\$0
LBU	medium matte walnut	+\$0

Top/Edge Finish: Wood Veneer

For veneer top/veneer edge (W)

2U	light brown walnut A	+\$85
40	dark brown walnut A	+\$85
CHD	noble cherry	+\$85
ET	clear on ash A	+\$85
EU	oak on ash A	+\$85
EV	walnut on ash A	+\$85
EW	medium matte walnut A	+\$85
UL	natural maple A	+\$85
WHN	natural white oak	+\$85

Top/Edge Finish: Opaque Formcoat®

For painted Formcoat® top/edge (P)

8Q	folkstone grey	+\$0
91	white	+\$0
LU	soft white	+\$0

Step 8. Edge Finish

For high-pressure laminate top/thermoplastic edge (L) or thermally-fused laminate top/thermoplastic edge (M)

76	light brown walnut	+\$0
8Q	folkstone grey	+\$0
91	white	+\$0
98	studio white	+\$0
CL	cool grey neutral	+\$0
LBA	clear on ash	+\$0
LBR	phantom ecru	+\$0
LBS	phantom cocoa	+\$0
LBU	medium matte walnut	+\$0
LBV	warm grey teak	+\$0
LBB	oak on ash	+\$0
LBC	walnut on ash	+\$0
LBF	neutral twill	+\$0
LBJ	graphite twill	+\$0
LBQ	white twill	+\$0
WL	sandstone	+\$0
WN	warm grey neutral	+\$0
HF	inner tone light	+\$0
HM	natural maple	+\$0
HP	light anigre	+\$0
HX	aged cherry	+\$0
LU	soft white	+\$0

Step 9. Leg Finish

Metallic Paint

For post leg (P) or T-leg (T)

CN	metallic champagne	+\$0
EH	metallic bronze	+\$0
MS	metallic silver	+\$0
SNA	satin aluminum	+\$30
SNB	satin bronze	+\$30
SNC	satin carbon	+\$30

Sand Texture Paint

For post leg (P) or T-leg (T)

BK	black	+\$0
-----------	-------	------

Smooth Paint

For post leg (P) or T-leg (T)

8Q	folkstone grey	+\$0
91	white	+\$0
98	studio white	+\$0
BU	black umber	+\$0
CL	cool grey neutral	+\$0
G2	graphite satin	+\$0
HF	inner tone light	+\$0
LU	soft white	+\$0
MT	medium tone	+\$0
SG	slate grey	+\$0
WL	sandstone	+\$0
WN	warm grey neutral	+\$0

For post leg (P) or T-leg (T)

CD	polished aluminum	+\$110
-----------	-------------------	--------

Metallic Paint

For T-leg with height adjustment (A)

CN	metallic champagne	+\$0
EH	metallic bronze	+\$0
MS	metallic silver	+\$0
SNA	satin aluminum	+\$30
SNB	satin bronze	+\$30
SNC	satin carbon	+\$30

Classroom Curve Table *continued*

Everywhere™ Standard-Height Tables

Smooth Paint

For T-leg with height adjustment (A)

8Q	folkstone grey	+\$0
91	white	+\$0
98	studio white	+\$0
BU	black umber	+\$0
CL	cool grey neutral	+\$0
G2	graphite satin	+\$0
HF	inner tone light	+\$0
LU	soft white	+\$0
MT	medium tone	+\$0
SG	slate grey	+\$0
WL	sandstone	+\$0
WN	warm grey neutral	+\$0

For T-leg with height adjustment (A)

CD	polished aluminum	+\$110
-----------	-------------------	--------

Step 10. Casters/Glides

20	casters	+\$0
57	glides	+\$0

Conference Corner Table

DT1ME.
DT1MS.
DT1MT.

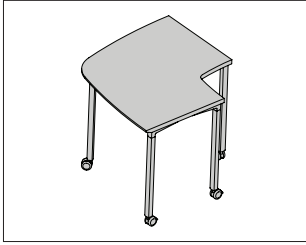

Product Information

Description

This corner table comes in multiple edge styles and has a laminate top with thermoplastic edge, veneer top and edge, or painted top and edge. It has multiple leg/base options, and is available with casters or glides. The caster option has 2 locking and 2 non-locking casters. Glides have 1/2" leveling range. Shipped knocked down.

Notes

Tables have an additional (5th) leg for stability.
Additional ganging bracket kits (Y1338.) can be used with adjacent tables.
For additional details on available edge options see Appendices.

Dimensions

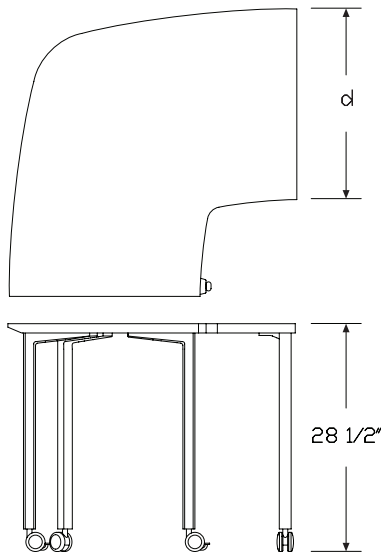

Specification Information

Step 1.

DT1M

Step 2. Edge

- S.** squared-edge
- T.** thin-edge
- E.** eased-edge

Step 3. Depth

- 24** 24" deep
- 30** 30" deep

Step 4. Surface Material

For squared-edge (S.)

- L** high-pressure laminate top/thermoplastic edge
- M** thermally-fused laminate top/thermoplastic edge
- W** veneer top/veneer edge **A**
- P** painted Formcoat® top/edge

For thin-edge (T.)

- W** veneer top/veneer edge **A**
- P** painted Formcoat® top/edge

For eased-edge (E.)

- P** painted Formcoat® top/edge

Step 5. Leg/Base Type

- P** post leg

Prices for Steps 1-5.

	P
DT1MS.24 L	\$1764
M	\$1633
W	\$2094
P	\$1908
30 L	\$2119
M	\$1962
W	\$2538
P	\$2284
P	
DT1MT.24 W	\$2512
P	\$2028
30 W	\$3049
P	\$2433

	P
DT1ME.24 P	\$2028
30 P	\$2433

Step 6.

Top Finish

For high-pressure laminate top/thermoplastic edge (L)

28	canyon	+\$0
29	misted	+\$0
38	twilight	+\$0
39	desert	+\$0
76	light brown walnut	+\$0
91	white	+\$0
98	studio white	+\$0
8Q	folkstone grey	+\$0
CL	cool grey neutral	+\$0
HF	inner tone light	+\$0
HM	natural maple	+\$0
HP	light anigre	+\$0
HX	aged cherry	+\$0
LBA	clear on ash	+\$0
LBR	phantom ecru	+\$0
LBS	phantom cocoa	+\$0
LBU	medium matte walnut	+\$0
LBV	warm grey teak	+\$0
LBB	oak on ash	+\$0
LBC	walnut on ash	+\$0
LBF	neutral twill	+\$0
LBJ	graphite twill	+\$0
LBQ	white twill	+\$0
LT	light tone	+\$0
LU	soft white	+\$0
WL	sandstone	+\$0
WN	warm grey neutral	+\$0
X1	chalk white	+\$0

Top Finish

For thermally-fused laminate top/thermoplastic edge (M)

8Q	folkstone grey	+\$0
91	white	+\$0
98	studio white	+\$0
HM	natural maple	+\$0
LBA	clear on ash	+\$0
LBB	oak on ash	+\$0
LBC	walnut on ash	+\$0
LBF	neutral twill	+\$0
LBQ	white twill	+\$0
LBU	medium matte walnut	+\$0

Top/Edge Finish: Wood Veneer

For veneer top/veneer edge (W)

2U	light brown walnut A	+\$85
40	dark brown walnut A	+\$85
CHD	noble cherry	+\$85
ET	clear on ash A	+\$85
EU	oak on ash A	+\$85
EV	walnut on ash A	+\$85
EW	medium matte walnut A	+\$85
UL	natural maple A	+\$85
WHN	natural white oak	+\$85

Top/Edge Finish: Opaque Formcoat®

For painted Formcoat® top/edge (P)

8Q	folkstone grey	+\$0
91	white	+\$0
LU	soft white	+\$0

Step 7. Edge Finish

For high-pressure laminate top/thermoplastic edge (L) or thermally-fused laminate top/thermoplastic edge (M)

76	light brown walnut	+\$0
8Q	folkstone grey	+\$0
91	white	+\$0
98	studio white	+\$0
CL	cool grey neutral	+\$0
LBA	clear on ash	+\$0
LBR	phantom ecru	+\$0
LBS	phantom cocoa	+\$0
LBU	medium matte walnut	+\$0
LBV	warm grey teak	+\$0
LBB	oak on ash	+\$0
LBC	walnut on ash	+\$0
LBF	neutral twill	+\$0
LBJ	graphite twill	+\$0
LBQ	white twill	+\$0
WL	sandstone	+\$0
WN	warm grey neutral	+\$0
HF	inner tone light	+\$0
HM	natural maple	+\$0
HP	light anigre	+\$0
HX	aged cherry	+\$0
LU	soft white	+\$0

Step 8. Leg/Base Finish

Metallic Paint

CN	metallic champagne	+\$0
EH	metallic bronze	+\$0
MS	metallic silver	+\$0
SNA	satin aluminum	+\$30
SNB	satin bronze	+\$30
SNC	satin carbon	+\$30

Sand Texture Paint

BK	black	+\$0
-----------	-------	------

Smooth Paint

8Q	folkstone grey	+\$0
91	white	+\$0
98	studio white	+\$0
BU	black umber	+\$0
CL	cool grey neutral	+\$0
G2	graphite satin	+\$0
HF	inner tone light	+\$0
LU	soft white	+\$0
MT	medium tone	+\$0
SG	slate grey	+\$0
WL	sandstone	+\$0
WN	warm grey neutral	+\$0
CD	polished aluminum	+\$110

Step 9. Casters/Glides

20	casters	+\$0
57	glides	+\$0

Round Corner Table

DT1NE.
DT1NS.
DT1NT.

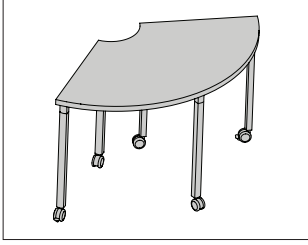

Product Information

Description

This corner table comes in multiple edge styles and has a laminate top with thermoplastic edge, veneer top and edge, or painted top and edge. It has multiple leg/base options, and is available with casters or glides. The caster option has 2 locking and 2 non-locking casters. Glides have 1/2" leveling range. Shipped knocked down.

Notes

Tables have an additional (5th) leg for stability.

3 36" deep tables ganged together make an 84" diameter table.

Additional ganging bracket kits (Y1338.), sold separately, can be used to ensure proper alignment with adjacent tables.

For additional details on available edge options see Appendices.

UL listed when used with Connect™ single circuit electrical product (Y137x.) with post leg (P) option.

Dimensions

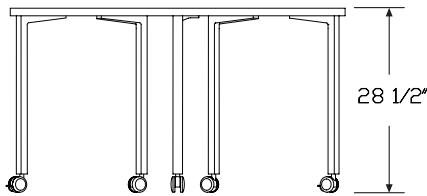
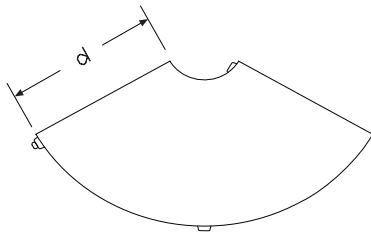

Specification Information

Step 1.

DT1N

Step 2. Edge

- S.** squared-edge
- T.** thin-edge
- E.** eased-edge

Step 3. Depth

- 24** 24" deep
- 30** 30" deep
- 36** 36" deep

Step 4. Surface Material

For squared-edge (S.)

- L** high-pressure laminate top/thermoplastic edge
- M** thermally-fused laminate top/thermoplastic edge
- W** veneer top/veneer edge **A**
- P** painted Formcoat® top/edge

For thin-edge (T.)

- W** veneer top/veneer edge **A**
- P** painted Formcoat® top/edge

For eased-edge (E.)

- P** painted Formcoat® top/edge

Step 5. Leg/Base Type

- P** post leg

Prices for Steps 1-5.

	P
DT1NS. 24 L	\$1766
M	\$1633
W	\$2094
P	\$1908
30 L	\$2121
M	\$1961
W	\$2538
P	\$2284
36 L	\$2473
M	\$2287
W	\$2987
P	\$2665

Round Corner Table *continued*

	P
DT1NT. 24 W	\$2512
P	\$2028
30 W	\$3049
P	\$2433
36 W	\$3582
P	\$2840
	P
DT1NE. 24 P	\$2028
30 P	\$2433
36 P	\$2840

Step 6.

Top Finish		
<i>For high-pressure laminate top/thermoplastic edge (L)</i>		
28	canyon	+\$0
29	misted	+\$0
38	twilight	+\$0
39	desert	+\$0
76	light brown walnut	+\$0
91	white	+\$0
98	studio white	+\$0
8Q	folkstone grey	+\$0
CL	cool grey neutral	+\$0
HF	inner tone light	+\$0
HM	natural maple	+\$0
HP	light anigre	+\$0
HX	aged cherry	+\$0
LBA	clear on ash	+\$0
LBR	phantom ecru	+\$0
LBS	phantom cocoa	+\$0
LBU	medium matte walnut	+\$0
LBV	warm grey teak	+\$0
LBB	oak on ash	+\$0
LBC	walnut on ash	+\$0
LBF	neutral twill	+\$0
LBJ	graphite twill	+\$0
LBQ	white twill	+\$0
LT	light tone	+\$0
LU	soft white	+\$0
WL	sandstone	+\$0
WN	warm grey neutral	+\$0
X1	chalk white	+\$0

Top Finish		
<i>For thermally-fused laminate top/thermoplastic edge (M)</i>		
8Q	folkstone grey	+\$0
91	white	+\$0
98	studio white	+\$0
HM	natural maple	+\$0
LBA	clear on ash	+\$0
LBB	oak on ash	+\$0
LBC	walnut on ash	+\$0
LBF	neutral twill	+\$0
LBQ	white twill	+\$0
LBU	medium matte walnut	+\$0

Top/Edge Finish: Wood Veneer		
<i>For veneer top/veneer edge (W)</i>		
2U	light brown walnut A	+\$85
40	dark brown walnut A	+\$85
CHD	noble cherry	+\$85
ET	clear on ash A	+\$85
EU	oak on ash A	+\$85
EV	walnut on ash A	+\$85
EW	medium matte walnut A	+\$85
UL	natural maple A	+\$85
WHN	natural white oak	+\$85

Top/Edge Finish: Opaque Formcoat®		
<i>For painted Formcoat® top/edge (P)</i>		
8Q	folkstone grey	+\$0
91	white	+\$0
LU	soft white	+\$0

Round Corner Table *continued*

Everywhere™ Standard-Height Tables

Step 7. Edge Finish

For high-pressure laminate top/thermoplastic edge (L) or thermally-fused laminate top/thermoplastic edge (M)

76	light brown walnut	+\$0
8Q	folkstone grey	+\$0
91	white	+\$0
98	studio white	+\$0
CL	cool grey neutral	+\$0
LBA	clear on ash	+\$0
LBR	phantom ecru	+\$0
LBS	phantom cocoa	+\$0
LBU	medium matte walnut	+\$0
LBV	warm grey teak	+\$0
LBB	oak on ash	+\$0
LBC	walnut on ash	+\$0
LBF	neutral twill	+\$0
LBJ	graphite twill	+\$0
LBQ	white twill	+\$0
WL	sandstone	+\$0
WN	warm grey neutral	+\$0
HF	inner tone light	+\$0
HM	natural maple	+\$0
HP	light anigre	+\$0
HX	aged cherry	+\$0
LU	soft white	+\$0

Step 8. Leg/Base Finish

Metallic Paint

CN	metallic champagne	+\$0
EH	metallic bronze	+\$0
MS	metallic silver	+\$0
SNA	satin aluminum	+\$30
SNB	satin bronze	+\$30
SNC	satin carbon	+\$30

Sand Texture Paint

BK	black	+\$0
-----------	-------	------

Smooth Paint

8Q	folkstone grey	+\$0
91	white	+\$0
98	studio white	+\$0
BU	black umber	+\$0
CL	cool grey neutral	+\$0
G2	graphite satin	+\$0
HF	inner tone light	+\$0
LU	soft white	+\$0
MT	medium tone	+\$0
SG	slate grey	+\$0
WL	sandstone	+\$0
WN	warm grey neutral	+\$0
CD	polished aluminum	+\$110

Step 9. Casters/Glides

20	casters	+\$0
57	glides	+\$0

Flip-Top Rectangular Table

DT5AE.
DT5AS.
DT5AT.

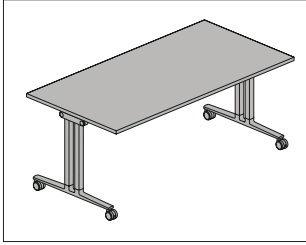

Product Information

Description

This rectangular table comes in multiple edge styles and has a laminate top with thermoplastic edge, laminate top with a thermoplastic backed plywood edge, veneer top and edge, or painted top and edge. It has 2 paddles under the front edge that allow the surface to flip up, minimizing space for storage when not in use. The table has T-legs and is available with casters or glides. The caster option has 2 locking and 2 non-locking casters. Glides have $\frac{1}{2}$ " leveling range. Shipped knocked down.

Notes

Thin edge and eased edge tops not available with 18" deep surfaces. Cable grommet options available through Vary Easy Program for round pass through grommet with $2\frac{1}{4}$ " hole clearance. Holes are located 3" from rear edge and 6" from end for the L and R options. Covers not provided with painted surface option.

Cutouts available for all Connect™ power and data accessories (see Thrive™ Portfolio). Cutouts will be located in the center, laterally, and approximately 3" from the rear edge of surface.

Multiple tables can be nested for storage when surface is flipped up. First table in nest requires 23" of floor space. All additional tables require only 9" of additional space.

Table top overhangs the base by $2\frac{3}{4}$ " on each end.

For additional details on available edge options see Appendices.

Only fabric modesty panel (Y1114.) will enable flip top table to fold as intended. It is the recommended modesty panel for use with flip top tables. It is full length and folds out of the way for table storage.

For additional size, edge, finish, and cable management options, see Vary Easy Program in Appendices.

UL listed when used with Connect single circuit electrical product (Y137x.) with T-leg (T) option.

MicrobeCare™ is an antimicrobial coating applied to the laminate or veneer surface of this product.

MicrobeCare™ protects products from mold, mildew, algae, and bacteria that cause deterioration, discoloration, odors, and stains.

MicrobeCare™ is registered with the US Environmental Protection Agency (EPA).

Dimensions

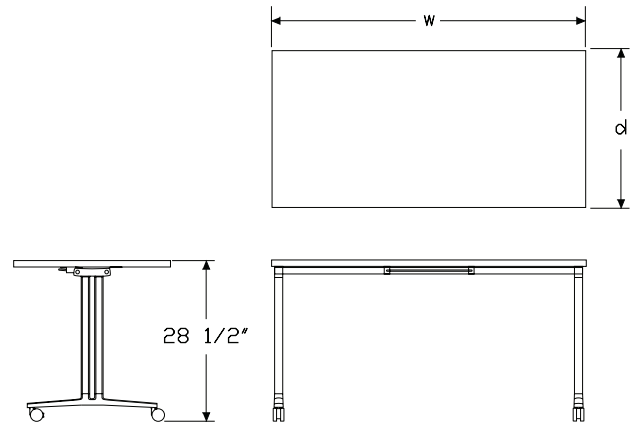

Flip-Top Rectangular Table *continued*

Specification Information	
Step 1.	
DT5A	
Step 2. Edge	
S.	squared-edge
T.	thin-edge
E.	eased-edge
Step 3. Depth	
<i>For squared-edge (S.)</i>	
18	18" deep
24	24" deep
30	30" deep
<i>For eased-edge (E.)</i>	
24	24" deep
30	30" deep
<i>For thin-edge (T.)</i>	
24	24" deep
30	30" deep
Step 4. Width	
48	48" wide
60	60" wide
72	72" wide
Step 5. Surface Material	
<i>For squared-edge (S.)</i>	
L	high-pressure laminate top/thermoplastic edge
M	thermally-fused laminate top/thermoplastic edge
U	high-pressure laminate/universal edge
T	thermally-fused laminate top/universal edge
W	veneer top/veneer edge A
P	painted Formcoat® top/edge
A	high-pressure laminate top/thermoplastic edge with MicrobeCare™ A
J	thermally-fused laminate top/thermoplastic edge with MicrobeCare™ A
B	veneer top/veneer edge with MicrobeCare™ A
C	high-pressure laminate top/universal edge with MicrobeCare™ A
K	thermally-fused laminate top/universal edge with MicrobeCare™ A

<i>For thin-edge (T.)</i>	
W	veneer top/veneer edge A
P	painted Formcoat® top/edge
B	veneer top/veneer edge with MicrobeCare™ A

<i>For eased-edge (E.)</i>	
P	painted Formcoat® top/edge

Step 6. Leg Type	
T	T-leg

Prices for Steps 1-6.							
		LT	MT	UT	TT	WT	PT
DT5AS. 18	48	\$2097	1964	2097	1964	2410	2287
	60	\$2201	2061	2201	2061	2538	2400
	72	\$2312	2165	2312	2165	2666	2518
	24 48	\$2141	2005	2141	2005	2460	2333
	60	\$2248	2105	2248	2105	2593	2452
	72	\$2358	2209	2358	2209	2722	2571
	30 48	\$2271	2127	2271	2127	2611	2470
	60	\$2472	2316	2472	2316	2853	2694
	72	\$2596	2431	2596	2431	2998	2827
		AT	JT	BT	CT	KT	
DT5AS. 18	48	\$2198	2058	2505	2198	2058	
	60	\$2300	2155	2633	2300	2155	
	72	\$2412	2260	2761	2412	2260	
	24 48	\$2241	2099	2556	2241	2099	
	60	\$2348	2199	2687	2348	2199	
	72	\$2458	2302	2817	2458	2302	
	30 48	\$2369	2219	2707	2369	2219	
	60	\$2575	2411	2949	2575	2411	
	72	\$2697	2526	3093	2697	2526	
		LT	MT	UT	TT	WT	PT
DT5AT. 24	48	—	—	—	—	\$2950	2487
	60	—	—	—	—	\$3107	2608
	72	—	—	—	—	\$3265	2738
	30 48	—	—	—	—	\$3136	2633
	60	—	—	—	—	\$3421	2869
	72	—	—	—	—	\$3596	3012
		AT	JT	BT	CT	KT	
DT5AT. 24	48	—	—	\$3044	—	—	
	60	—	—	\$3202	—	—	
	72	—	—	\$3359	—	—	

Flip-Top Rectangular Table *continued*

30 48	—	—	\$3229	—	—
60	—	—	\$3517	—	—
72	—	—	\$3690	—	—
	LT	MT	UT	TT	WT
DT5AE. 24 48	—	—	—	—	— \$2487
60	—	—	—	—	— \$2608
72	—	—	—	—	— \$2738
30 48	—	—	—	—	— \$2633
60	—	—	—	—	— \$2869
72	—	—	—	—	— \$3012

Step 7.

Top Finish

For high-pressure laminate top/thermoplastic edge (L), high-pressure laminate/universal edge (U), high-pressure laminate top/thermoplastic edge with MicrobeCare™ (A), or high-pressure laminate top/universal edge with MicrobeCare™ (C)

76	light brown walnut	+\$0
91	white	+\$0
98	studio white	+\$0
8Q	folkstone grey	+\$0
CL	cool grey neutral	+\$0
HF	inner tone light	+\$0
HM	natural maple	+\$0
HP	light anigre	+\$0
HX	aged cherry	+\$0
LBA	clear on ash	+\$0
LBR	phantom ecru	+\$0
LBS	phantom cocoa	+\$0
LBU	medium matte walnut	+\$0
LBV	warm grey teak	+\$0
LBB	oak on ash	+\$0
LBC	walnut on ash	+\$0
LBF	neutral twill	+\$0
LBJ	graphite twill	+\$0
LBQ	white twill	+\$0
LU	soft white	+\$0
WL	sandstone	+\$0
WN	warm grey neutral	+\$0

Top Finish

For thermally-fused laminate top/thermoplastic edge (M), thermally-fused laminate top/universal edge (T), thermally-fused laminate top/thermoplastic edge with MicrobeCare™ (J), or thermally-fused laminate top/universal edge with MicrobeCare™ (K)

8Q	folkstone grey	+\$0
91	white	+\$0
98	studio white	+\$0
HM	natural maple	+\$0
LBA	clear on ash	+\$0
LBB	oak on ash	+\$0
LBC	walnut on ash	+\$0
LBF	neutral twill	+\$0
LBQ	white twill	+\$0
LBU	medium matte walnut	+\$0

Top/Edge Finish: Wood Veneer

For veneer top/veneer edge (W) or veneer top/veneer edge with MicrobeCare™ (B)

2U	light brown walnut A	+\$50
40	dark brown walnut A	+\$50
CHD	noble cherry	+\$50
ET	clear on ash A	+\$50
EU	oak on ash A	+\$50
EV	walnut on ash A	+\$50
EW	medium matte walnut A	+\$50
UL	natural maple A	+\$50
WHN	natural white oak	+\$50

Top/Edge Finish: Opaque Formcoat®

For painted Formcoat® top/edge (P)

8Q	folkstone grey	+\$0
91	white	+\$0
LU	soft white	+\$0

Flip-Top Rectangular Table *continued*

Step 8. Edge Finish

For high-pressure laminate top/thermoplastic edge (L), thermally-fused laminate top/thermoplastic edge (M), high-pressure laminate top/thermoplastic edge with MicrobeCare™ (A), or thermally-fused laminate top/thermoplastic edge with MicrobeCare™ (J)

76	light brown walnut	+\$0
8Q	folkstone grey	+\$0
91	white	+\$0
98	studio white	+\$0
CL	cool grey neutral	+\$0
LBA	clear on ash	+\$0
LBR	phantom ecru	+\$0
LBS	phantom cocoa	+\$0
LBU	medium matte walnut	+\$0
LBV	warm grey teak	+\$0
LBB	oak on ash	+\$0
LBC	walnut on ash	+\$0
LBF	neutral twill	+\$0
LBJ	graphite twill	+\$0
LBQ	white twill	+\$0
WL	sandstone	+\$0
WN	warm grey neutral	+\$0
HF	inner tone light	+\$0
HM	natural maple	+\$0
HP	light anigre	+\$0
HX	aged cherry	+\$0
LU	soft white	+\$0

For high-pressure laminate/universal edge (U), thermally-fused laminate top/universal edge (T), high-pressure laminate top/universal edge with MicrobeCare™ (C), or thermally-fused laminate top/universal edge with MicrobeCare™ (K)

PLY	plywood edge	+\$50
------------	--------------	-------

Step 9. Leg Finish

Metallic Paint

CN	metallic champagne	+\$0
EH	metallic bronze	+\$0
MS	metallic silver	+\$0
SNA	satin aluminum	+\$30
SNB	satin bronze	+\$30
SNC	satin carbon	+\$30

Sand Texture Paint

BK	black	+\$0
-----------	-------	------

Smooth Paint

8Q	folkstone grey	+\$0
91	white	+\$0
98	studio white	+\$0
BU	black umber	+\$0
CL	cool grey neutral	+\$0
G2	graphite satin	+\$0
HF	inner tone light	+\$0
LU	soft white	+\$0
MT	medium tone	+\$0
SG	slate grey	+\$0
WL	sandstone	+\$0
WN	warm grey neutral	+\$0
CD	polished aluminum	+\$110

Step 10. Casters/Glides

20	casters	+\$0
57	glides	+\$0

Wedge Table

DT1WS.

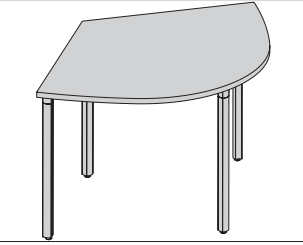

Product Information

Description

This wedge table comes in square edge style and has a laminate top with thermoplastic edge or veneer top and edge. It has post legs with casters or glides. Caster option has 2 locking and 2 non-locking casters. Glides have 1/2" leveling range. Shipped knocked down.

Notes

Cable grommet options available through Vary Easy program for round pass-through grommet with 2 1/4" hole clearance. Holes are located 3" from rear edge and 6" from end for L and R options.

Reinforcement channels are used under table tops 54" wide and wider. They will be located along the center line for 18"-deep and 24"-deep surfaces, and 19" from the front edge for 30"-deep surfaces.

UL Listed when used with Connect™ single circuit electrical product (Y137x.) with post leg (P).

Additional ganging bracket kits (Y1338.) can be used with adjacent tables.

For additional size, edge, finish, and cable management options, see Vary Easy Program in appendices.

Dimensions

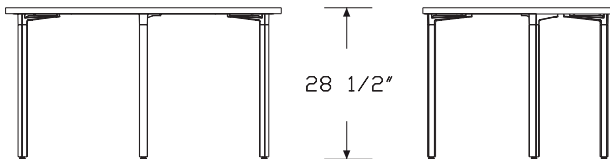
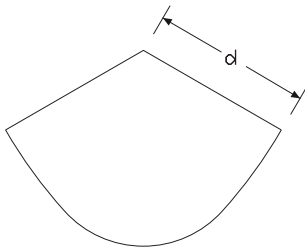

Specification Information

Step 1.

DT1W

Step 2. Edge

S. squared-edge

Step 3. Depth

24 24" deep

30 30" deep

36 36" deep

Step 4. Surface Material

For squared-edge (S.)

L high-pressure laminate top/thermoplastic edge

M thermally-fused laminate top/thermoplastic edge

W veneer top/veneer edge **A**

Step 5. Leg Type

P post leg

Prices for Steps 1-5.

	P
DT1WS.24 L	\$1562
M	\$1456
W	\$2112
30 L	\$1731
M	\$1614
W	\$2308
36 L	\$1968
M	\$1835
W	\$2583

Step 6.

Top Finish

For high-pressure laminate top/thermoplastic edge (L)

76	light brown walnut	+\$0
8Q	folkstone grey	+\$0
91	white	+\$0
98	studio white	+\$0
CL	cool grey neutral	+\$0
HF	inner tone light	+\$0
HM	natural maple	+\$0
HP	light anigre	+\$0
HX	aged cherry	+\$0
LBA	clear on ash	+\$0
LBB	oak on ash	+\$0
LBC	walnut on ash	+\$0
LBF	neutral twill	+\$0
LBJ	graphite twill	+\$0
LBQ	white twill	+\$0
LBR	phantom ecru	+\$0
LBS	phantom cocoa	+\$0
LBU	medium matte walnut	+\$0
LBV	warm grey teak	+\$0
LT	light tone	+\$0
LU	soft white	+\$0
WL	sandstone	+\$0
WN	warm grey neutral	+\$0

Top Finish

For thermally-fused laminate top/thermoplastic edge (M)

8Q	folkstone grey	+\$0
91	white	+\$0
98	studio white	+\$0
HM	natural maple	+\$0
LBA	clear on ash	+\$0
LBB	oak on ash	+\$0
LBC	walnut on ash	+\$0
LBF	neutral twill	+\$0
LBQ	white twill	+\$0
LBU	medium matte walnut	+\$0

Top/Edge Finish: Wood Veneer

For veneer top/veneer edge (W)

OU	walnut	+\$50
2U	light brown walnut A	+\$50
40	dark brown walnut A	+\$50
EW	medium matte walnut A	+\$50
ET	clear on ash	+\$50
EU	oak on ash	+\$50
EV	walnut on ash	+\$50
UL	natural maple A	+\$50

Step 7. Edge Finish

For high-pressure laminate top/thermoplastic edge (L) or thermally-fused laminate top/thermoplastic edge (M)

76	light brown walnut	+\$0
8Q	folkstone grey	+\$0
91	white	+\$0
98	studio white	+\$0
BU	black umber	+\$0
CL	cool grey neutral	+\$0
HF	inner tone light	+\$0
HM	natural maple	+\$0
HP	light anigre	+\$0
HX	aged cherry	+\$0
LBA	clear on ash	+\$0
LBB	oak on ash	+\$0
LBC	walnut on ash	+\$0
LBF	neutral twill	+\$0
LBJ	graphite twill	+\$0
LBQ	white twill	+\$0
LBR	phantom ecru	+\$0
LBS	phantom cocoa	+\$0
LBU	medium matte walnut	+\$0
LBV	warm grey teak	+\$0
LU	soft white	+\$0
WL	sandstone	+\$0
WN	warm grey neutral	+\$0

Step 8. Leg Finish

Metallic Paint

CN	metallic champagne	+\$0
EH	metallic bronze	+\$0
MS	metallic silver	+\$0

Sand Texture Paint

BK	black	+\$0
-----------	-------	------

Wedge Table *continued*

Smooth Paint

8Q	folkstone grey	+\$0
91	white	+\$0
98	studio white	+\$0
BU	black	+\$0
CL	cool grey neutral	+\$0
G2	graphite satin	+\$0
HF	inner tone light	+\$0
LU	soft white	+\$0
MT	medium tone	+\$0
SG	slate grey	+\$0
WL	sandstone	+\$0
WN	warm grey neutral	+\$0

Polished Aluminum

CD	polished aluminum	+\$110
-----------	-------------------	--------

Step 9. Casters/Glides

20	casters	+\$0
57	glides	+\$0

Soft Rectangle - Extended Meeting Table

DT1PS.
DT1PT.

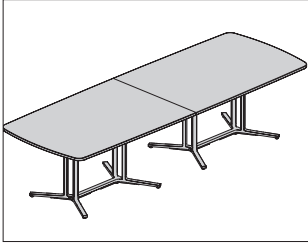

Everywhere™ Standard-Height Tables

Product Information

Description

This 2-piece conference table comes in multiple edge styles and has a laminate top with thermoplastic edge or veneer top and edge. It has multiple leg/base options. Glides have 1/2" leveling range. Shipped knocked down.

Dimensions

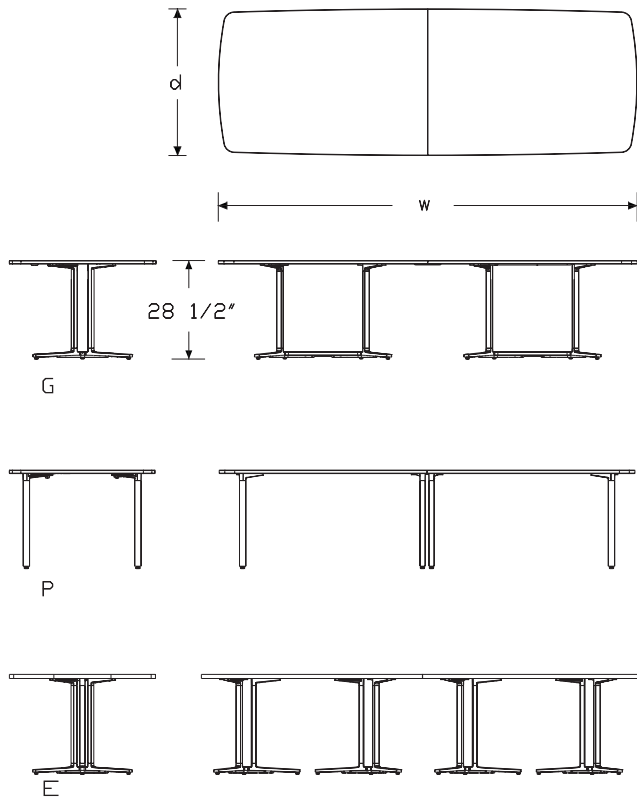

Specification Information

Step 1.

DT1P

Step 2. Edge

S. squared-edge
T. thin-edge

Step 3. Depth

42 42" deep
48 48" deep

Step 4. Width

120 120" wide
144 144" wide
168 168" wide

Step 5. Surface Material

For squared-edge (S.)

L high-pressure laminate top/thermoplastic edge
M thermally-fused laminate top/thermoplastic edge
W veneer top/veneer edge

For thin-edge (T.)

W veneer top/veneer edge

Step 6. Leg/Base Type

For 120" wide (120)

P post leg
G double 3-column base, spanner

For 144" wide (144) or 168" wide (168)

P post leg
E double 3-column base
G double 3-column base, spanner

Prices for Steps 1-6.

	LP	LE	LG	MP	ME	MG
DT1PS. 42 120	\$3371	—	4517	3118	—	4178
144	\$3650	5630	4865	3375	5207	4499
168	\$3963	5908	5143	3664	5463	4756
48 120	\$3546	—	4657	3279	—	4306
144	\$3720	5630	4865	3440	5207	4499
168	\$3891	5976	5213	3599	5527	4821

Soft Rectangle - Extended Meeting Table *continued*

	WP	WE	WG
DT1PS. 42 120	\$3978	—	5345
144	\$5411	7300	6517
168	\$5932	7821	7169
48 120	\$4890	—	5932
144	\$5736	7561	6778
168	\$6388	8083	7431
	WP	WE	WG
DT1PT. 42 120	\$5672	—	6778
144	\$6584	8472	7756
168	\$7169	8994	8342
48 120	\$5932	—	6975
144	\$6909	8800	8083
168	\$7561	9386	8603

Step 7.

Top Finish

For high-pressure laminate top/thermoplastic edge (L)

76	light brown walnut <input type="checkbox"/>	+\$0
8Q	folkstone grey <input type="checkbox"/>	+\$0
91	white <input type="checkbox"/>	+\$0
98	studio white <input type="checkbox"/>	+\$0
CL	cool grey neutral <input type="checkbox"/>	+\$0
HF	inner tone light <input type="checkbox"/>	+\$0
HM	natural maple <input type="checkbox"/>	+\$0
HP	light anigre <input type="checkbox"/>	+\$0
HX	aged cherry <input type="checkbox"/>	+\$0
LBA	clear on ash <input type="checkbox"/>	+\$0
LBB	oak on ash <input type="checkbox"/>	+\$0
LBC	walnut on ash <input type="checkbox"/>	+\$0
LBF	neutral twill <input type="checkbox"/>	+\$0
LBJ	graphite twill <input type="checkbox"/>	+\$0
LBQ	white twill <input type="checkbox"/>	+\$0
LBR	phantom ecru <input type="checkbox"/>	+\$0
LBS	phantom cocoa <input type="checkbox"/>	+\$0
LBU	medium matte walnut <input type="checkbox"/>	+\$0
LBV	warm grey teak <input type="checkbox"/>	+\$0
LT	light tone <input type="checkbox"/>	+\$0
LU	soft white <input type="checkbox"/>	+\$0
WL	sandstone <input type="checkbox"/>	+\$0
WN	warm grey neutral <input type="checkbox"/>	+\$0

Top Finish

For thermally-fused laminate top/thermoplastic edge (M)

8Q	folkstone grey <input type="checkbox"/>	+\$0
91	white <input type="checkbox"/>	+\$0
98	studio white <input type="checkbox"/>	+\$0
HM	natural maple <input type="checkbox"/>	+\$0
LBA	clear on ash <input type="checkbox"/>	+\$0
LBB	oak on ash <input type="checkbox"/>	+\$0
LBC	walnut on ash <input type="checkbox"/>	+\$0
LBF	neutral twill <input type="checkbox"/>	+\$0
LBQ	white twill <input type="checkbox"/>	+\$0
LBU	medium matte walnut <input type="checkbox"/>	+\$0

Top/Edge Finish

For veneer top/veneer edge (W)

2U	light brown walnut <input type="checkbox"/>	+\$0
40	dark brown walnut <input type="checkbox"/>	+\$0
A2	white ash <input type="checkbox"/>	+\$0
ET	clear on ash <input type="checkbox"/>	+\$0
EU	oak on ash <input type="checkbox"/>	+\$0
EV	walnut on ash <input type="checkbox"/>	+\$0
EW	medium matte walnut <input type="checkbox"/>	+\$0
OU	walnut <input type="checkbox"/>	+\$0
UL	natural maple <input type="checkbox"/>	+\$0

Soft Rectangle - Extended Meeting Table *continued*

Everywhere™ Standard-Height Tables

Step 8. Edge Finish

For high-pressure laminate top/thermoplastic edge (L) or thermally-fused laminate top/thermoplastic edge (M)

76	light brown walnut <input type="checkbox"/>	+\$0
8Q	folkstone grey <input type="checkbox"/>	+\$0
91	white <input type="checkbox"/>	+\$0
98	studio white <input type="checkbox"/>	+\$0
BU	black umber <input type="checkbox"/>	+\$0
CL	cool grey neutral <input type="checkbox"/>	+\$0
HF	inner tone light <input type="checkbox"/>	+\$0
HM	natural maple <input type="checkbox"/>	+\$0
HP	light anigre <input type="checkbox"/>	+\$0
HX	aged cherry <input type="checkbox"/>	+\$0
LBA	clear on ash <input type="checkbox"/>	+\$0
LBB	oak on ash <input type="checkbox"/>	+\$0
LBC	walnut on ash <input type="checkbox"/>	+\$0
LBF	neutral twill <input type="checkbox"/>	+\$0
LBJ	graphite twill <input type="checkbox"/>	+\$0
LBQ	white twill <input type="checkbox"/>	+\$0
LBR	phantom ecru <input type="checkbox"/>	+\$0
LBS	phantom cocoa <input type="checkbox"/>	+\$0
LBU	medium matte walnut <input type="checkbox"/>	+\$0
LBV	warm grey teak <input type="checkbox"/>	+\$0
LU	soft white <input type="checkbox"/>	+\$0
WL	sandstone <input type="checkbox"/>	+\$0
WN	warm grey neutral <input type="checkbox"/>	+\$0
X1	chalk white <input type="checkbox"/>	+\$0

Step 9. Leg Finish

8Q	folkstone grey <input type="checkbox"/>	+\$0
91	white <input type="checkbox"/>	+\$0
98	studio white <input type="checkbox"/>	+\$0
BU	black umber <input type="checkbox"/>	+\$0
CL	cool grey neutral <input type="checkbox"/>	+\$0
G2	graphite satin <input type="checkbox"/>	+\$0
HF	inner tone light <input type="checkbox"/>	+\$0
LU	soft white <input type="checkbox"/>	+\$0
MT	medium tone <input type="checkbox"/>	+\$0
SG	slate grey <input type="checkbox"/>	+\$0
WL	sandstone <input type="checkbox"/>	+\$0
WN	warm grey neutral <input type="checkbox"/>	+\$0
CN	metallic champagne <input type="checkbox"/>	+\$0
EH	metallic bronze <input type="checkbox"/>	+\$0
MS	metallic silver <input type="checkbox"/>	+\$0
CD	polished aluminum <input type="checkbox"/>	+\$110

Step 10. Grommets

253	cutout for Y1420. or Y1425. - 3 port <input type="checkbox"/>	+\$27
254	cutout for Y1420. or Y1425. - 5 port <input type="checkbox"/>	+\$27
255	cutout for Y1420. or Y1425. - 6 port <input type="checkbox"/>	+\$27
NTG	no grommet <input type="checkbox"/>	+\$0

Half Round Table

DT1RS.

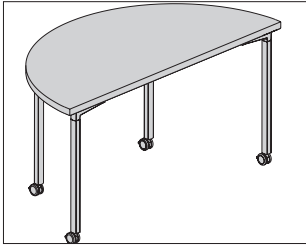

Product Information

Description

This half-round table comes in square edge style and has a laminate top with thermoplastic edge or veneer top and edge. It has post legs with casters or glides. Caster option has 2 locking and 2 non-locking casters. Glides have 1/2" leveling range. Shipped knocked down.

Notes

Cable grommet options available through Vary Easy program for round pass-through grommet with 2 1/4" hole clearance. Holes are located 3" from rear edge and 6" from end for L and R options.

Reinforcement channels are used under table tops 54" wide and wider. They will be located along the center line for 18"-deep and 24"-deep surfaces, and 19" from the front edge for 30"-deep surfaces.

UL Listed when used with Connect™ single circuit electrical product (Y137x.) with post leg (P).

Additional ganging bracket kits (Y1338.) can be used with adjacent tables.

For additional size, edge, finish, and cable management options, see Vary Easy Program in appendices.

Dimensions

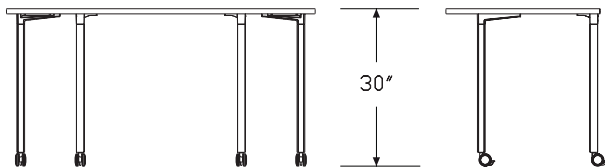
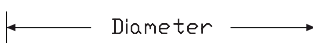
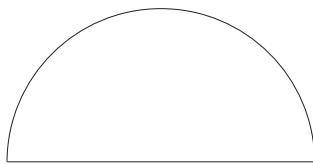

Specification Information

Step 1.

DT1R

Step 2. Edge

S. squared-edge

Step 3. Diameter

48 48" diameter

60 60" diameter

72 72" diameter

Step 4. Surface Material

For squared-edge (S.)

L high-pressure laminate top/thermoplastic edge

M thermally-fused laminate top/thermoplastic edge

W veneer top/veneer edge **A**

Step 5. Leg Type

P post leg

Prices for Steps 1-5.

	P
DT1RS. 48 L	\$1412
M	\$1316
W	\$1830
60 L	\$1758
M	\$1639
W	\$2100
72 L	\$2029
M	\$1891
W	\$2610

Half Round Table *continued*

Step 6.

Top Finish

For high-pressure laminate top/thermoplastic edge (L)

38	twilight	+\$0
39	desert	+\$0
76	light brown walnut	+\$0
91	white	+\$0
98	studio white	+\$0
8Q	folkstone grey	+\$0
CL	cool grey neutral	+\$0
HF	inner tone light	+\$0
HM	natural maple	+\$0
HP	light anigre	+\$0
HX	aged cherry	+\$0
LBA	clear on ash	+\$0
LBR	phantom ecru	+\$0
LBS	phantom cocoa	+\$0
LBU	medium matte walnut	+\$0
LBV	warm grey teak	+\$0
LBB	oak on ash	+\$0
LBC	walnut on ash	+\$0
LBF	neutral twill	+\$0
LBJ	graphite twill	+\$0
LBQ	white twill	+\$0
LU	soft white	+\$0
WL	sandstone	+\$0
WN	warm grey neutral	+\$0

Top Finish

For thermally-fused laminate top/thermoplastic edge (M)

8Q	folkstone grey	+\$0
91	white	+\$0
98	studio white	+\$0
HM	natural maple	+\$0
LBA	clear on ash	+\$0
LBB	oak on ash	+\$0
LBC	walnut on ash	+\$0
LBF	neutral twill	+\$0
LBQ	white twill	+\$0
LBU	medium matte walnut	+\$0

Top/Edge Finish: Wood Veneer

For veneer top/veneer edge (W)

2U	light brown walnut A	+\$85
40	dark brown walnut A	+\$85
CHD	noble cherry	+\$85
ET	clear on ash A	+\$85
EU	oak on ash A	+\$85
EV	walnut on ash A	+\$85
EW	medium matte walnut A	+\$85
UL	natural maple A	+\$85
WHN	natural white oak	+\$85

Step 7. Edge Finish

For high-pressure laminate top/thermoplastic edge (L) or thermally-fused laminate top/thermoplastic edge (M)

76	light brown walnut	+\$0
8Q	folkstone grey	+\$0
91	white	+\$0
98	studio white	+\$0
CL	cool grey neutral	+\$0
LBA	clear on ash	+\$0
LBR	phantom ecru	+\$0
LBS	phantom cocoa	+\$0
LBU	medium matte walnut	+\$0
LBV	warm grey teak	+\$0
LBB	oak on ash	+\$0
LBC	walnut on ash	+\$0
LBF	neutral twill	+\$0
LBJ	graphite twill	+\$0
LBQ	white twill	+\$0
WL	sandstone	+\$0
WN	warm grey neutral	+\$0
HF	inner tone light	+\$0
HM	natural maple	+\$0
HP	light anigre	+\$0
HX	aged cherry	+\$0
LU	soft white	+\$0

Step 8. Leg/Base Finish

Metallic Paint

CN	metallic champagne	+\$0
EH	metallic bronze	+\$0
MS	metallic silver	+\$0
SNA	satin aluminum	+\$30
SNB	satin bronze	+\$30
SNC	satin carbon	+\$30

Half Round Table *continued*

Sand Texture Paint		
BK	black	+\$0

Smooth Paint		
8Q	folkstone grey	+\$0
91	white	+\$0
98	studio white <input type="checkbox"/> A	+\$0
BU	black umber	+\$0
CL	cool grey neutral	+\$0
G2	graphite satin	+\$0
HF	inner tone light	+\$0
LU	soft white	+\$0
MT	medium tone	+\$0
SG	slate grey	+\$0
WL	sandstone	+\$0
WN	warm grey neutral	+\$0
CD	polished aluminum	+\$110

Step 9. Casters/Glides		
20	casters	+\$0
57	glides	+\$0

Trapezoid Table

DT1TS.

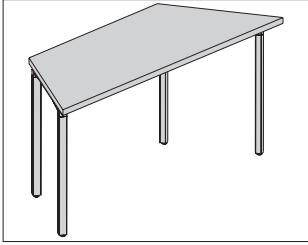

Everywhere™ Standard-Height Tables

Product Information

Description

This trapezoid table comes in square edge style and has a laminate top with thermoplastic edge or universal edge, or veneer top and edge. It comes in several leg types with casters or glides. Caster option has 2 locking and 2 non-locking casters. Glides have 1/2" leveling range. Shipped knocked down.

Notes

Cable grommet options available through Vary Easy program for round pass-through grommet with 2 1/4" hole clearance. Holes are located 3" from rear edge and 6" from end for L and R options.

Reinforcement channels are used under table tops 54" wide and wider. They will be located along the center line for 18"-deep and 24"-deep surfaces, and 19" from the front edge for 30"-deep surfaces.

UL Listed when used with Connect™ single circuit electrical product (Y137x.) with post leg (P) and T-leg (T) options.

Additional ganging bracket kits (Y1338.) can be used with adjacent tables.

For additional size, edge, finish, and cable management options, see Vary Easy Program in appendices.

Dimensions

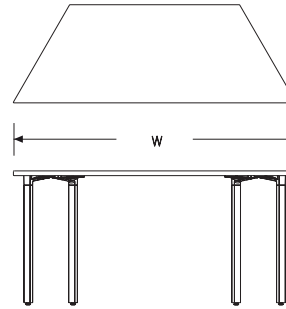

Post Leg

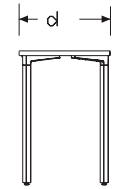

C-Leg

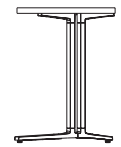

T-Leg



Trapezoid Table *continued*

Everywhere™ Standard-Height Tables

Specification Information

Step 1.

DT1T

Step 2. Edge

S. squared-edge

Step 3. Depth

24 24" deep

30 30" deep

Step 4. Width

48 48" wide

60 60" wide

72 72" wide

Step 5. Surface Material

For squared-edge (S.)

L high-pressure laminate top/thermoplastic edge

M thermally-fused laminate top/thermoplastic edge

U high-pressure laminate/universal edge

T thermally-fused laminate top/universal edge

W veneer top/veneer edge A

Step 6. Leg Type

P post leg

T T-leg

C C-leg

Prices for Steps 1-6.

	LP	LT	LC	MP	MT	MC
DT1TS. 24 48	\$1466	1774	1774	1366	1654	1654
60	\$1697	2005	2005	1582	1869	1869
72	\$1872	2182	2182	1745	2033	2033
30 48	\$1513	1823	1823	1410	1699	1699
60	\$1731	2040	2040	1614	1902	1902
72	\$1942	2248	2248	1810	2095	2095
	UP	UT	UC	TP	TT	TC
DT1TS. 24 48	\$1466	1774	1774	1366	1654	1654
60	\$1697	2005	2005	1582	1869	1869
72	\$1872	2182	2182	1745	2033	2033
30 48	\$1513	1823	1823	1410	1699	1699
60	\$1731	2040	2040	1614	1902	1902
72	\$1942	2248	2248	1810	2095	2095

	WP	WT	WC
DT1TS. 24 48	\$2001	2358	2358
60	\$2269	2626	2626
72	\$2472	2832	2832
30 48	\$2056	2415	2415
60	\$2308	2667	2667
72	\$2553	2908	2908

Step 7.

Top Finish

For high-pressure laminate top/thermoplastic edge (L) or high-pressure laminate/universal edge (U)

28	canyon	+\$0
29	misted	+\$0
38	twilight	+\$0
39	desert	+\$0
76	light brown walnut	+\$0
91	white	+\$0
98	studio white	+\$0
8Q	folkstone grey	+\$0
CL	cool grey neutral	+\$0
HF	inner tone light	+\$0
HM	natural maple	+\$0
HP	light anigre	+\$0
HX	aged cherry	+\$0
LBA	clear on ash	+\$0
LBR	phantom ecru	+\$0
LBS	phantom cocoa	+\$0
LBU	medium matte walnut	+\$0
LBV	warm grey teak	+\$0
LBB	oak on ash	+\$0
LBC	walnut on ash	+\$0
LBF	neutral twill	+\$0
LBJ	graphite twill	+\$0
LBQ	white twill	+\$0
LT	light tone	+\$0
LU	soft white	+\$0
WL	sandstone	+\$0
WN	warm grey neutral	+\$0
X1	chalk white	+\$0

Trapezoid Table *continued*

Top Finish		
<i>For thermally-fused laminate top/thermoplastic edge (M) or thermally-fused laminate top/universal edge (T)</i>		
8Q	folkstone grey	+\$0
91	white	+\$0
98	studio white	+\$0
HM	natural maple	+\$0
LBA	clear on ash	+\$0
LBB	oak on ash	+\$0
LBC	walnut on ash	+\$0
LBF	neutral twill	+\$0
LBQ	white twill	+\$0
LBU	medium matte walnut	+\$0

Top/Edge Finish: Wood Veneer		
<i>For veneer top/veneer edge (W)</i>		
2U	light brown walnut <input type="checkbox"/> A	+\$50
40	dark brown walnut <input type="checkbox"/> A	+\$50
CHD	noble cherry	+\$0
ET	clear on ash <input type="checkbox"/> A	+\$50
EU	oak on ash <input type="checkbox"/> A	+\$50
EV	walnut on ash <input type="checkbox"/> A	+\$50
EW	medium matte walnut <input type="checkbox"/> A	+\$50
UL	natural maple <input type="checkbox"/> A	+\$50
WHN	natural white oak	+\$0

Step 8. Edge Finish		
<i>For high-pressure laminate top/thermoplastic edge (L) or thermally-fused laminate top/thermoplastic edge (M)</i>		
76	light brown walnut	+\$0
8Q	folkstone grey	+\$0
91	white	+\$0
98	studio white	+\$0
CL	cool grey neutral	+\$0
LBA	clear on ash	+\$0
LBR	phantom ecru	+\$0
LBS	phantom cocoa	+\$0
LBU	medium matte walnut	+\$0
LBV	warm grey teak	+\$0
LBB	oak on ash	+\$0
LBC	walnut on ash	+\$0
LBF	neutral twill	+\$0
LBJ	graphite twill	+\$0
LBQ	white twill	+\$0
WL	sandstone	+\$0
WN	warm grey neutral	+\$0
HF	inner tone light	+\$0
HM	natural maple	+\$0
HP	light anigre	+\$0
HX	aged cherry	+\$0
LU	soft white	+\$0

<i>For high-pressure laminate/universal edge (U) or thermally-fused laminate top/universal edge (T)</i>		
PLY	plywood edge	+\$50

Step 9. Leg Finish		
Metallic Paint		
CN	metallic champagne	+\$0
EH	metallic bronze	+\$0
MS	metallic silver	+\$0
SNA	satin aluminum	+\$30
SNB	satin bronze	+\$30
SNC	satin carbon	+\$30

Trapezoid Table *continued*

Smooth Paint

8Q	folkstone grey	+\$0
91	white	+\$0
98	studio white	+\$0
BU	black umber	+\$0
CL	cool grey neutral	+\$0
G2	graphite satin	+\$0
HF	inner tone light	+\$0
LU	soft white	+\$0
MT	medium tone	+\$0
SG	slate grey	+\$0
WL	sandstone	+\$0
WN	warm grey neutral	+\$0
BK	black	+\$0
CD	polished aluminum	+\$110

Step 10. Casters/Glides

20	casters	+\$0
57	glides	+\$0

Standard-Height Table Leg

DT2A.

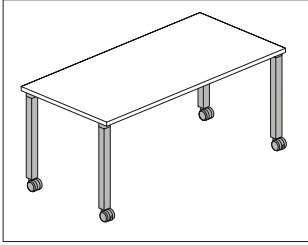

Product Information

Description

This product is a kit of a full set of table legs with attachment hardware. It has multiple leg options, and is available with casters or glides. The caster option has 2 locking and 2 non-locking casters. Glides have 1/2" leveling range. Shipped knocked down.

Notes

Height adjustable table legs have a 5" range in 1" increments.

Tabletop must be no more than 30" deep and no less than 24" deep for C and D options. Tabletop must be no more than 36" deep and no less than 18" deep for P, A, and T options.

Tabletops 54" and wider are recommended to have a steel support channel.

Not recommended for tables wider than 84".

Table leg must be located such that the floor glides are not more than 3" from the front and rear sides for table stability.

Tabletop can over hang sides of table base by no more than 15" for tops 60" and wider.

1" long screws provided with base are recommended to attach to tabletop. Ensure mounting surface is no less than 1" thick.

Everywhere™ Standard-Height Table Legs and Bases

Dimensions

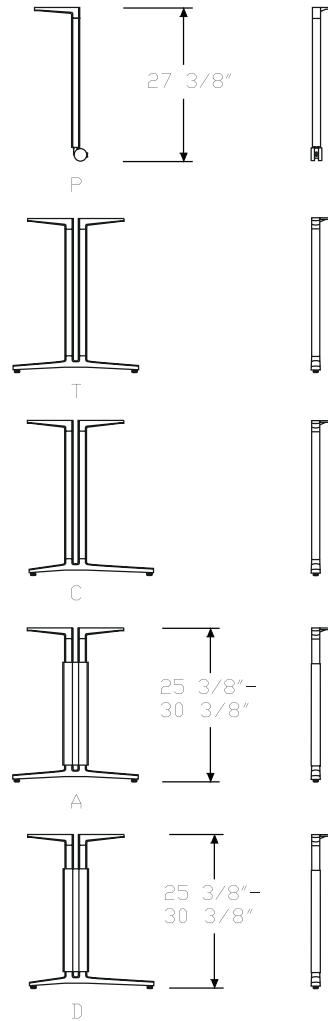

Standard-Height Table Leg *continued*

Specification Information

Step 1.

DT2A.

Step 2. Depth

18	18" deep
24	24" deep
30	30" deep
36	36" deep

Step 3. Leg Type

For 18" deep (18) or 36" deep (36)

P	post leg
T	T-leg
A	T-leg with height adjustment

For 24" deep (24) or 30" deep (30)

P	post leg
T	T-leg
A	T-leg with height adjustment
C	C-leg
D	C-leg with height adjustment

Step 4. Table Top Surface Material

For post leg (P)

P	Painted table top
Z	high-pressure laminate or veneer table top

For T-leg (T), T-leg with height adjustment (A), C-leg (C), or C-leg with height adjustment (D)

N	laminate, painted or veneer table top
----------	---------------------------------------

Prices for Steps 1-4.

	N	P	Z
DT2A. 18 P	—	\$780	780
T	\$988	—	—
A	\$1503	—	—
24 P	—	\$780	780
T	\$1022	—	—
A	\$1553	—	—
C	\$1022	—	—
D	\$1572	—	—

30 P	—	\$780	780
T	\$1022	—	—
A	\$1553	—	—
C	\$1022	—	—
D	\$1572	—	—

36 P	—	\$780	780
T	\$1077	—	—
A	\$1609	—	—

Step 5. Leg Finish

Metallic Paint

For post leg (P), T-leg (T), or C-leg (C)

CN	metallic champagne	+\$0
EH	metallic bronze	+\$0
MS	metallic silver	+\$0
SNA	satin aluminum	+\$30
SNB	satin bronze	+\$30
SNC	satin carbon	+\$30

Sand Texture Paint

For post leg (P), T-leg (T), or C-leg (C)

BK	black	+\$0
-----------	-------	------

Smooth Paint

For post leg (P), T-leg (T), or C-leg (C)

8Q	folkstone grey	+\$0
91	white	+\$0
98	studio white	+\$0
BU	black umber	+\$0
CL	cool grey neutral	+\$0
G2	graphite satin	+\$0
HF	inner tone light	+\$0
LU	soft white	+\$0
MT	medium tone	+\$0
SG	slate grey	+\$0
WL	sandstone	+\$0
WN	warm grey neutral	+\$0

For post leg (P), T-leg (T), or C-leg (C)

CD	polished aluminum	+\$110
-----------	-------------------	--------

Standard-Height Table Leg *continued*

Everywhere™ Standard-Height Table Legs and Bases

Metallic Paint

For T-leg with height adjustment (A) or C-leg with height adjustment (D)

CN	metallic champagne	+\$0
EH	metallic bronze	+\$0
MS	metallic silver	+\$0

Smooth Paint

For T-leg with height adjustment (A) or C-leg with height adjustment (D)

8Q	folkstone grey	+\$0
91	white	+\$0
98	studio white	+\$0
BU	black umber	+\$0
CL	cool grey neutral	+\$0
G2	graphite satin	+\$0
HF	inner tone light	+\$0
LU	soft white	+\$0
MT	medium tone	+\$0
SG	slate grey	+\$0
WL	sandstone	+\$0
WN	warm grey neutral	+\$0

For T-leg with height adjustment (A) or C-leg with height adjustment (D)

CD	polished aluminum	+\$110
-----------	-------------------	--------

Step 6. Casters/Glides

20	casters	+\$0
57	glides	+\$0

Standard-Height Table Base

DT2B.

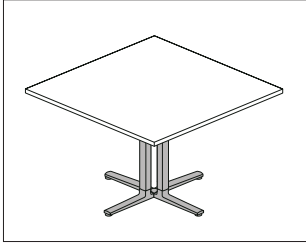

Product Information

Description

This product is a kit of a full set of center column table legs with attachment hardware. It has either single column S or 4 column X leg options, and is available with casters or glides. The caster option has 2 locking and 2 non-locking casters. Glides have 1/2" leveling range. Shipped knocked down.

Notes

Tabletop must be no more than 42" deep and no less than 30" deep for X base.

Tabletop must be no more than 36" deep and no less than 24" deep for S base.

Table base to be centered side-to-side and left-to-right under tabletop.

Tabletop can over hang sides of table base by no more than 15" for tops 60" and wider.

1" long screws provided with base are recommended to attach to tabletop. Ensure mounting surface is no less than 1" thick.

Dimensions

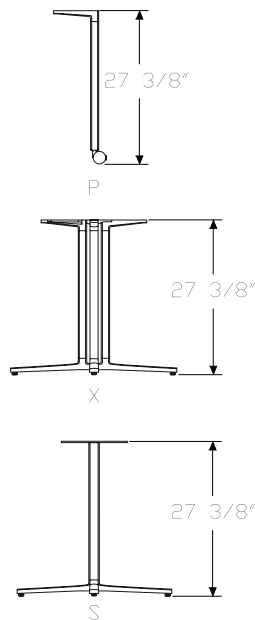

Specification Information

Step 1.

DT2B.

Step 2. Leg/Base Type

X	4-column base
S	single-column base

Prices for Steps 1-2.

DT2B. X	\$1089
S	\$759

Step 3. Leg/Base Finish

Metallic Paint

CN	metallic champagne	+\$0
EH	metallic bronze	+\$0
MS	metallic silver	+\$0
SNA	satin aluminum	+\$30
SNB	satin bronze	+\$30
SNC	satin carbon	+\$30

Sand Texture Paint

BK	black	+\$0
-----------	-------	------

Smooth Paint

8Q	folkstone grey	+\$0
91	white	+\$0
98	studio white	+\$0
BU	black umber	+\$0
CL	cool grey neutral	+\$0
G2	graphite satin	+\$0
HF	inner tone light	+\$0
LU	soft white	+\$0
MT	medium tone	+\$0
SG	slate grey	+\$0
WL	sandstone	+\$0
WN	warm grey neutral	+\$0
CD	polished aluminum	+\$110

Step 4. Casters/Glides

20	casters	+\$0
57	glides	+\$0

Standing-Height Square Table

DT3BE.
DT3BS.
DT3BT.

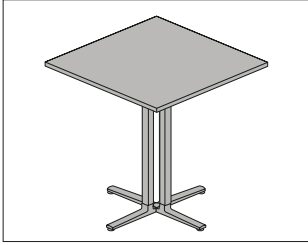

Everywhere™ Standing-Height Tables

Product Information

Description

This 42"-high, square table comes in multiple edge styles and has a laminate top with thermoplastic edge, laminate top with a thermoplastic backed plywood edge, veneer top and edge, or painted top and edge. The base has glides with 1/2" leveling range. Shipped knocked down.

Notes

For additional details on available edge options see Appendices.
For additional size, edge, and finish options, see Vary Easy Program in Appendices.

Dimensions

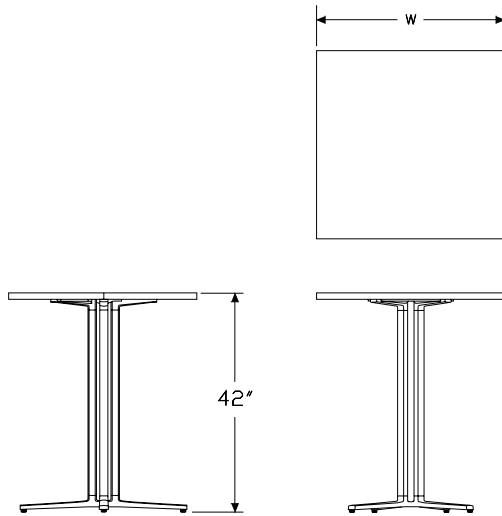

Specification Information

Step 1.

DT3B

Step 2. Edge

- S.** squared-edge
- T.** thin-edge
- E.** eased-edge

Step 3. Depth/Width

- 3030** 30" deep x 30" wide
- 3636** 36" deep x 36" wide

Step 4. Surface Material

For squared-edge (S.)

- L** high-pressure laminate top/thermoplastic edge
- M** thermally-fused laminate top/thermoplastic edge
- U** high-pressure laminate/universal edge
- T** thermally-fused laminate top/universal edge
- W** veneer top/veneer edge **A**
- P** painted Formcoat® top/edge

For thin-edge (T.)

- W** veneer top/veneer edge **A**
- P** painted Formcoat® top/edge

For eased-edge (E.)

- P** painted Formcoat® top/edge

Step 5. Base Type

- X** 4-column base

Prices for Steps 1-5.

	X
DT3BS. 3030 L	\$1383
M	\$1318
U	\$1383
T	\$1318
W	\$1578
P	\$1528
3636 L	\$1656
M	\$1579
U	\$1656
T	\$1579
W	\$1909
P	\$1834

Standing-Height Square Table

continued

	X
DT3BT. 3030 W	\$1895
P	\$1627
3636 W	\$2285
P	\$1949
	X
DT3BE. 3030 P	\$1627
3636 P	\$1949

Step 6.

Top Finish

For high-pressure laminate top/thermoplastic edge (L) or high-pressure laminate/universal edge (U)

76	light brown walnut	+\$0
91	white	+\$0
98	studio white	+\$0
8Q	folkstone grey	+\$0
CL	cool grey neutral	+\$0
HF	inner tone light	+\$0
HM	natural maple	+\$0
HP	light anigre	+\$0
HX	aged cherry	+\$0
LBA	clear on ash	+\$0
LBR	phantom ecru	+\$0
LBS	phantom cocoa	+\$0
LBU	medium matte walnut	+\$0
LBV	warm grey teak	+\$0
LBB	oak on ash	+\$0
LBC	walnut on ash	+\$0
LBF	neutral twill	+\$0
LBJ	graphite twill	+\$0
LBQ	white twill	+\$0
LU	soft white	+\$0
WL	sandstone	+\$0
WN	warm grey neutral	+\$0

Top Finish

For thermally-fused laminate top/thermoplastic edge (M) or thermally-fused laminate top/universal edge (T)

8Q	folkstone grey	+\$0
91	white	+\$0
98	studio white	+\$0
HM	natural maple	+\$0
LBA	clear on ash	+\$0
LBB	oak on ash	+\$0
LBC	walnut on ash	+\$0
LBF	neutral twill	+\$0
LBQ	white twill	+\$0
LBU	medium matte walnut	+\$0

Top/Edge Finish: Wood Veneer

For veneer top/veneer edge (W)

2U	light brown walnut A	+\$50
40	dark brown walnut A	+\$50
CHD	noble cherry	+\$50
ET	clear on ash A	+\$50
EU	oak on ash A	+\$50
EV	walnut on ash A	+\$50
EW	medium matte walnut A	+\$50
UL	natural maple A	+\$50
WHN	natural white oak	+\$50

Top/Edge Finish: Opaque Formcoat®

For painted Formcoat® top/edge (P)

8Q	folkstone grey	+\$0
91	white	+\$0
LU	soft white	+\$0

Standing-Height Square Table

continued

Everywhere™ Standing-Height Tables

Step 7. Edge Finish

For high-pressure laminate top/thermoplastic edge (L) or thermally-fused laminate top/thermoplastic edge (M)

76	light brown walnut	+\$0
8Q	folkstone grey	+\$0
91	white	+\$0
98	studio white	+\$0
CL	cool grey neutral	+\$0
LBA	clear on ash	+\$0
LBR	phantom ecru	+\$0
LBS	phantom cocoa	+\$0
LBU	medium matte walnut	+\$0
LBV	warm grey teak	+\$0
LBB	oak on ash	+\$0
LBC	walnut on ash	+\$0
LBF	neutral twill	+\$0
LBJ	graphite twill	+\$0
LBQ	white twill	+\$0
WL	sandstone	+\$0
WN	warm grey neutral	+\$0
HF	inner tone light	+\$0
HM	natural maple	+\$0
HP	light anigre	+\$0
HX	aged cherry	+\$0
LU	soft white	+\$0

For high-pressure laminate/universal edge (U) or thermally-fused laminate top/universal edge (T)

PLY	plywood edge	+\$50
------------	--------------	-------

Step 8. Base Finish

Metallic Paint

CN	metallic champagne	+\$0
EH	metallic bronze	+\$0
MS	metallic silver	+\$0
SNA	satin aluminum	+\$30
SNB	satin bronze	+\$30
SNC	satin carbon	+\$30

Sand Texture Paint

BK	black	+\$0
-----------	-------	------

Smooth Paint

8Q	folkstone grey	+\$0
91	white	+\$0
98	studio white	+\$0
BU	black umber	+\$0
CL	cool grey neutral	+\$0
G2	graphite satin	+\$0
HF	inner tone light	+\$0
LU	soft white	+\$0
MT	medium tone	+\$0
SG	slate grey	+\$0
WL	sandstone	+\$0
WN	warm grey neutral	+\$0
CD	polished aluminum	+\$110

Standing-Height Round Table

DT3CE.
DT3CS.
DT3CT.



Product Information

Description

This 42"-high, round table comes in multiple edge styles and has a laminate top with thermoplastic edge, veneer top and edge, or painted top and edge. The base has glides with 1/2" leveling range. Shipped knocked down.

Notes

For additional details on available edge options see Appendices.
For additional size, edge, and finish options, see Vary Easy Program in Appendices.

Dimensions

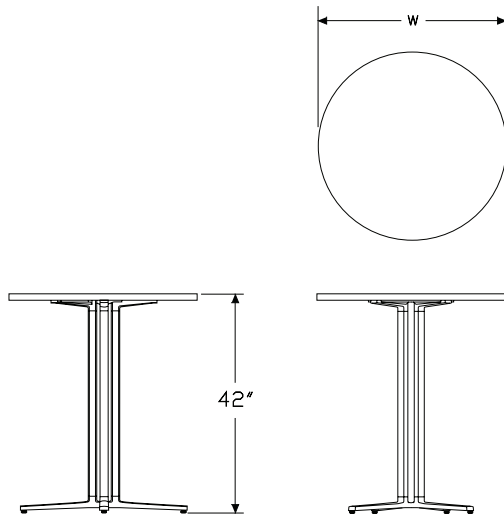

Specification Information

Step 1.

DT3C

Step 2. Edge

- S.** squared-edge
- T.** thin-edge
- E.** eased-edge

Step 3. Diameter

- 30** 30" diameter
- 36** 36" diameter

Step 4. Surface Material

For squared-edge (S.)

- L** high-pressure laminate top/thermoplastic edge
- M** thermally-fused laminate top/thermoplastic edge
- W** veneer top/veneer edge **A**
- P** painted Formcoat® top/edge

For thin-edge (T.)

- W** veneer top/veneer edge **A**
- P** painted Formcoat® top/edge

For eased-edge (E.)

- P** painted Formcoat® top/edge

Step 5. Base Type

- X** 4-column base

Prices for Steps 1-5.

	X
DT3CS. 30 L	\$1599
M	\$1514
W	\$1811
P	\$1758
36 L	\$1918
M	\$1816
W	\$2191
P	\$2108
	X
DT3CT. 30 W	\$2175
P	\$1869
36 W	\$2631
P	\$2241

Standing-Height Round Table

continued

Everywhere™ Standing-Height Tables

	X
DT3CE. 30 P	\$1869
36 P	\$2241

Step 6.

Top Finish

For high-pressure laminate top/thermoplastic edge (L)

76	light brown walnut	+\$0
91	white	+\$0
98	studio white	+\$0
8Q	folkstone grey	+\$0
CL	cool grey neutral	+\$0
HF	inner tone light	+\$0
HM	natural maple	+\$0
HP	light anigre	+\$0
HX	aged cherry	+\$0
LBA	clear on ash	+\$0
LBR	phantom ecru	+\$0
LBS	phantom cocoa	+\$0
LBU	medium matte walnut	+\$0
LBV	warm grey teak	+\$0
LBB	oak on ash	+\$0
LBC	walnut on ash	+\$0
LBF	neutral twill	+\$0
LBJ	graphite twill	+\$0
LBQ	white twill	+\$0
LU	soft white	+\$0
WL	sandstone	+\$0
WN	warm grey neutral	+\$0

Top Finish

For thermally-fused laminate top/thermoplastic edge (M)

8Q	folkstone grey	+\$0
91	white	+\$0
98	studio white	+\$0
HM	natural maple	+\$0
LBA	clear on ash	+\$0
LBB	oak on ash	+\$0
LBC	walnut on ash	+\$0
LBF	neutral twill	+\$0
LBQ	white twill	+\$0
LBU	medium matte walnut	+\$0

Top/Edge Finish: Wood Veneer

For veneer top/veneer edge (W)

2U	light brown walnut A	+\$50
40	dark brown walnut A	+\$50
CHD	noble cherry	+\$50
ET	clear on ash A	+\$50
EU	oak on ash A	+\$50
EV	walnut on ash A	+\$50
EW	medium matte walnut A	+\$50
UL	natural maple A	+\$50
WHN	natural white oak	+\$50

Top/Edge Finish: Opaque Formcoat®

For painted Formcoat® top/edge (P)

8Q	folkstone grey	+\$0
91	white	+\$0
LU	soft white	+\$0

Step 7. Edge Finish

For high-pressure laminate top/thermoplastic edge (L) or thermally-fused laminate top/thermoplastic edge (M)

76	light brown walnut	+\$0
8Q	folkstone grey	+\$0
91	white	+\$0
98	studio white	+\$0
CL	cool grey neutral	+\$0
LBA	clear on ash	+\$0
LBR	phantom ecru	+\$0
LBS	phantom cocoa	+\$0
LBU	medium matte walnut	+\$0
LBV	warm grey teak	+\$0
LBB	oak on ash	+\$0
LBC	walnut on ash	+\$0
LBF	neutral twill	+\$0
LBJ	graphite twill	+\$0
LBQ	white twill	+\$0
WL	sandstone	+\$0
WN	warm grey neutral	+\$0
HF	inner tone light	+\$0
HM	natural maple	+\$0
HP	light anigre	+\$0
HX	aged cherry	+\$0
LU	soft white	+\$0

Standing-Height Round Table

continued

Step 8. Base Finish

Metallic Paint

CN	metallic champagne	+\$0
EH	metallic bronze	+\$0
MS	metallic silver	+\$0
SNA	satin aluminum	+\$30
SNB	satin bronze	+\$30
SNC	satin carbon	+\$30

Sand Texture Paint

BK	black	+\$0
-----------	-------	------

Smooth Paint

8Q	folkstone grey	+\$0
91	white	+\$0
98	studio white	+\$0
BU	black umber	+\$0
CL	cool grey neutral	+\$0
G2	graphite satin	+\$0
HF	inner tone light	+\$0
LU	soft white	+\$0
MT	medium tone	+\$0
SG	slate grey	+\$0
WL	sandstone	+\$0
WN	warm grey neutral	+\$0
CD	polished aluminum	+\$110

Occasional Table, Square

DT4BS.
DT4BT.

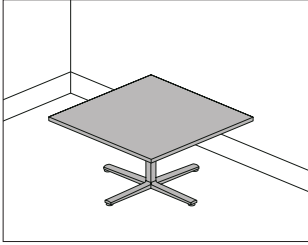

Product Information

Description
This 16"-high, square table comes in multiple edge styles and has a laminate top with thermoplastic edge, laminate top with a thermoplastic backed plywood edge, veneer top and edge, or painted top and edge. The base has glides with 1/2" leveling range. Shipped knocked down.

Notes

For additional details on available edge options see Appendices.
For additional size, edge, and finish options, see Vary Easy Program in Appendices.

Dimensions

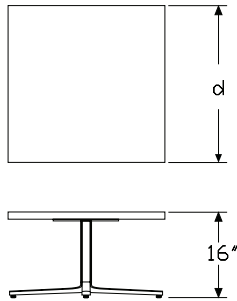

Everywhere™ Occasional Tables

Specification Information

Step 1.

DT4B

Step 2. Edge

- S.** squared-edge
- T.** thin-edge

Step 3. Depth/Width

- 2424** 24" deep x 24" wide
- 3030** 30" deep x 30" wide
- 3636** 36" deep x 36" wide

Step 4. Surface Material

For squared-edge (S.)

- L** high-pressure laminate top/thermoplastic edge
- M** thermally-fused laminate top/thermoplastic edge
- U** high-pressure laminate/universal edge
- T** thermally-fused laminate top/universal edge
- W** veneer top/veneer edge A
- P** painted Formcoat® top/edge

For thin-edge (T.)

- W** veneer top/veneer edge A
- P** painted Formcoat® top/edge

Step 5. Base Type

- S** single-column base

Prices for Steps 1-5.

	S
DT4BS. 2424 L	\$1067
M	\$1005
U	\$1067
T	\$1005
W	\$1185
P	\$1169
3030 L	\$1278
M	\$1204
U	\$1278
T	\$1204
W	\$1436
P	\$1400

Occasional Table, Square *continued*

3636 L	\$1470
M	\$1385
U	\$1470
T	\$1385
W	\$1661
P	\$1609
	S
DT4BT. 2424 W	\$1422
P	\$1242
3030 W	\$1724
P	\$1489
3636 W	\$1999
P	\$1713

Step 6.		
Top Finish		
<i>For high-pressure laminate top/thermoplastic edge (L) or high-pressure laminate/universal edge (U)</i>		
28	canyon	+\$0
29	misted	+\$0
38	twilight	+\$0
39	desert	+\$0
76	light brown walnut	+\$0
91	white	+\$0
98	studio white	+\$0
8Q	folkstone grey	+\$0
CL	cool grey neutral	+\$0
HF	inner tone light	+\$0
HM	natural maple	+\$0
HP	light anigre	+\$0
HX	aged cherry	+\$0
LBA	clear on ash	+\$0
LBR	phantom ecru	+\$0
LBS	phantom cocoa	+\$0
LBU	medium matte walnut	+\$0
LBV	warm grey teak	+\$0
LBB	oak on ash	+\$0
LBC	walnut on ash	+\$0
LBF	neutral twill	+\$0
LBJ	graphite twill	+\$0
LBQ	white twill	+\$0
LT	light tone	+\$0
LU	soft white	+\$0
WL	sandstone	+\$0
WN	warm grey neutral	+\$0
X1	chalk white	+\$0

Top Finish		
<i>For thermally-fused laminate top/thermoplastic edge (M) or thermally-fused laminate top/universal edge (T)</i>		
8Q	folkstone grey	+\$0
91	white	+\$0
98	studio white	+\$0
HM	natural maple	+\$0
LBA	clear on ash	+\$0
LBB	oak on ash	+\$0
LBC	walnut on ash	+\$0
LBF	neutral twill	+\$0
LBQ	white twill	+\$0
LBU	medium matte walnut	+\$0

Everywhere™ Occasional Tables

Occasional Table, Square *continued*

Top/Edge Finish: Wood Veneer

For veneer top/veneer edge (W)

2U	light brown walnut A	+\$50
40	dark brown walnut A	+\$50
CHD	noble cherry	+\$50
ET	clear on ash A	+\$50
EU	oak on ash A	+\$50
EV	walnut on ash A	+\$50
EW	medium matte walnut A	+\$50
UL	natural maple A	+\$50
WHN	natural white oak	+\$50

Top/Edge Finish: Opaque Formcoat®

For painted Formcoat® top/edge (P)

8Q	folkstone grey	+\$0
91	white	+\$0
LU	soft white	+\$0

Step 7. Edge Finish

For high-pressure laminate top/thermoplastic edge (L) or thermally-fused laminate top/thermoplastic edge (M)

76	light brown walnut	+\$0
8Q	folkstone grey	+\$0
91	white	+\$0
98	studio white	+\$0
CL	cool grey neutral	+\$0
HF	inner tone light	+\$0
HM	natural maple	+\$0
HP	light anigre	+\$0
HX	aged cherry	+\$0
LBA	clear on ash	+\$0
LBB	oak on ash	+\$0
LBC	walnut on ash	+\$0
LBF	neutral twill	+\$0
LBJ	graphite twill	+\$0
LBQ	white twill	+\$0
LBR	phantom ecru	+\$0
LBS	phantom cocoa	+\$0
LBU	medium matte walnut	+\$0
LBV	warm grey teak	+\$0
LU	soft white	+\$0
WL	sandstone	+\$0
WN	warm grey neutral	+\$0

For high-pressure laminate/universal edge (U) or thermally-fused laminate top/universal edge (T)

PLY	plywood edge	+\$50
------------	--------------	-------

Step 8. Base Finish

Metallic Paint

CN	metallic champagne	+\$0
EH	metallic bronze	+\$0
MS	metallic silver	+\$0
SNA	satin aluminum	+\$30
SNB	satin bronze	+\$30
SNC	satin carbon	+\$30

Sand Texture Paint

BK	black	+\$0
-----------	-------	------

Smooth Paint

8Q	folkstone grey	+\$0
91	white	+\$0
98	studio white	+\$0
BU	black umber	+\$0
CL	cool grey neutral	+\$0
G2	graphite satin	+\$0
HF	inner tone light	+\$0
LU	soft white	+\$0
MT	medium tone	+\$0
SG	slate grey	+\$0
WL	sandstone	+\$0
WN	warm grey neutral	+\$0
CD	polished aluminum	+\$110

Occasional Table, Round

DT4CS.
DT4CT.

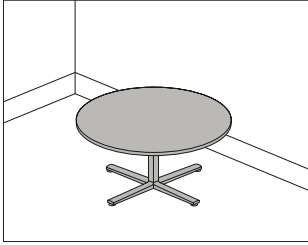

Product Information

Description

This 16"-high, round table comes in multiple edge styles and has a laminate top with thermoplastic edge, veneer top and edge, or painted top and edge. The base has glides with 1/2" leveling range. Shipped knocked down.

Notes

For additional details on available edge options see Appendices.
For additional size, edge, and finish options, see Vary Easy Program in Appendices.

Dimensions

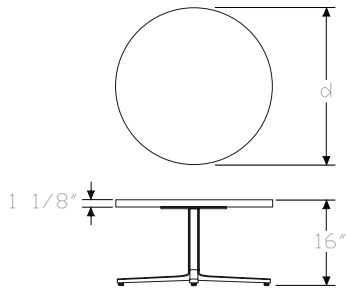

Specification Information

Step 1.

DT4C

Step 2. Edge

- S.** squared-edge
- T.** thin-edge

Step 3. Diameter

- 30** 30" diameter
- 36** 36" diameter

Step 4. Surface Material

For squared-edge (S.)

- L** high-pressure laminate top/thermoplastic edge
- M** thermally-fused laminate top/thermoplastic edge
- W** veneer top/veneer edge **A**
- P** painted Formcoat® top/edge

For thin-edge (T.)

- W** veneer top/veneer edge **A**
- P** painted Formcoat® top/edge

Step 5. Base Type

- S** single-column base

Prices for Steps 1-5.

	S
DT4CS. 30 L	\$1492
M	\$1377
W	\$1652
P	\$1608
36 L	\$1718
M	\$1584
W	\$1912
P	\$1847
	S
DT4CT. 30 W	\$1978
P	\$1712
36 W	\$2293
P	\$1968

Occasional Table, Round *continued*

Step 6.

Top Finish		
<i>For high-pressure laminate top/thermoplastic edge (L)</i>		
28	canyon	+\$0
29	misted	+\$0
38	twilight	+\$0
39	desert	+\$0
76	light brown walnut	+\$0
91	white	+\$0
98	studio white	+\$0
8Q	folkstone grey	+\$0
CL	cool grey neutral	+\$0
HF	inner tone light	+\$0
HM	natural maple	+\$0
HP	light anigre	+\$0
HX	aged cherry	+\$0
LBA	clear on ash	+\$0
LBR	phantom ecru	+\$0
LBS	phantom cocoa	+\$0
LBU	medium matte walnut	+\$0
LBV	warm grey teak	+\$0
LBB	oak on ash	+\$0
LBC	walnut on ash	+\$0
LBF	neutral twill	+\$0
LBJ	graphite twill	+\$0
LBQ	white twill	+\$0
LT	light tone	+\$0
LU	soft white	+\$0
WL	sandstone	+\$0
WN	warm grey neutral	+\$0
X1	chalk white	+\$0

Top Finish		
<i>For thermally-fused laminate top/thermoplastic edge (M)</i>		
8Q	folkstone grey	+\$0
91	white	+\$0
98	studio white	+\$0
HM	natural maple	+\$0
LBA	clear on ash	+\$0
LBB	oak on ash	+\$0
LBC	walnut on ash	+\$0
LBF	neutral twill	+\$0
LBQ	white twill	+\$0
LBU	medium matte walnut	+\$0

Top/Edge Finish: Wood Veneer		
<i>For veneer top/veneer edge (W)</i>		
2U	light brown walnut A	+\$50
40	dark brown walnut A	+\$50
CHD	noble cherry	+\$50
ET	clear on ash A	+\$50
EU	oak on ash A	+\$50
EV	walnut on ash A	+\$50
EW	medium matte walnut A	+\$50
UL	natural maple A	+\$50
WHN	natural white oak	+\$50

Top/Edge Finish: Opaque Formcoat®		
<i>For painted Formcoat® top/edge (P)</i>		
8Q	folkstone grey	+\$0
91	white	+\$0
LU	soft white	+\$0

Step 7. Edge Finish		
<i>For high-pressure laminate top/thermoplastic edge (L) or thermally-fused laminate top/thermoplastic edge (M)</i>		
76	light brown walnut	+\$0
8Q	folkstone grey	+\$0
91	white	+\$0
98	studio white	+\$0
CL	cool grey neutral	+\$0
HF	inner tone light	+\$0
HM	natural maple	+\$0
HP	light anigre	+\$0
HX	aged cherry	+\$0
LBA	clear on ash	+\$0
LBB	oak on ash	+\$0
LBC	walnut on ash	+\$0
LBF	neutral twill	+\$0
LBJ	graphite twill	+\$0
LBQ	white twill	+\$0
LBR	phantom ecru	+\$0
LBS	phantom cocoa	+\$0
LBU	medium matte walnut	+\$0
LBV	warm grey teak	+\$0
LU	soft white	+\$0
WL	sandstone	+\$0
WN	warm grey neutral	+\$0

Occasional Table, Round *continued*

Step 8. Base Finish

Metallic Paint

CN	metallic champagne	+\$0
EH	metallic bronze	+\$0
MS	metallic silver	+\$0
SNA	satin aluminum	+\$30
SNB	satin bronze	+\$30
SNC	satin carbon	+\$30

Sand Texture Paint

BK	black	+\$0
-----------	-------	------

Smooth Paint

8Q	folkstone grey	+\$0
91	white	+\$0
98	studio white	+\$0
BU	black umber	+\$0
CL	cool grey neutral	+\$0
G2	graphite satin	+\$0
HF	inner tone light	+\$0
LU	soft white	+\$0
MT	medium tone	+\$0
SG	slate grey	+\$0
WL	sandstone	+\$0
WN	warm grey neutral	+\$0
CD	polished aluminum	+\$110

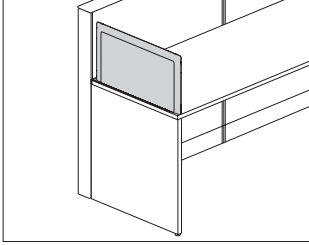

Product Information

Description

This tackable fabric screen attaches to a work surface either at the seam or at the right or left edge to provide division and boundary between workers. It attaches with no interference from supports below the work surface. Attachment hardware included.

Notes

Screen height is 13¹/₂" or 17¹/₂" above work surface, aligning with bead heights of 41" and 45".

Screen width matches work surface depths that have a 1" gap at the back edge.

2 attachment methods ship with the end-of-run right handed (CR) and end-of-run left handed (CL) screen. The screen can be installed using the bracket, or using threaded screws that drill bayonets directly into the surface. See planning guide for exact location of holes.

End-of-run screen does not work on Canvas Beam.

See planning guide for applications and other compatible product lines.

Screen accepts Customer's Own Material (COM). Yardage is estimated for nondirectional 54"-wide fabrics.

For vertical fabric direction (T):

Height—Yardage

42—1.19

46—1.45

For horizontal fabric direction (R):

Width—Yardage

24—0.90

30—1.10

36—1.30

For information on multiple quantities or directional fabrics, contact COM Department. See Order Information in Appendices.

Dimensions

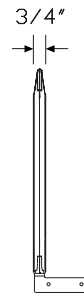
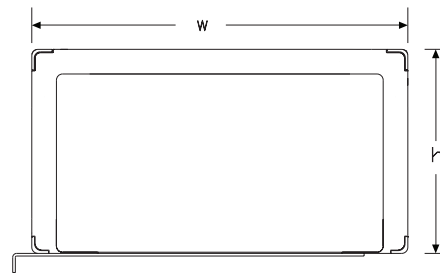

Specification Information

Step 1.

FT354.

Step 2. Attachment Type

CL Canvas Surface Attached, End of Run Left Handed

CR Canvas Surface Attached, End of Run Right Handed

Step 3. Height

42 42" high

46 46" high

Step 4. Width

24 24" wide

30 30" wide

36 36" wide

Step 5. Surface Material

R tackable fabric, horizontal

T tackable fabric

Prices for Steps 1-5.

	24R	24T	30R	30T	36R	36T
FT354. CL 42	\$1105	1105	1143	1143	1176	1176
46	\$1163	1163	1208	1208	1256	1256
CR 42	\$1105	1105	1143	1143	1176	1176
46	\$1163	1163	1208	1208	1256	1256

Step 6. Bracket Finish

8Q folkstone grey +\$0

91 white +\$0

98 studio white +\$0

BK black +\$0

G1 graphite +\$0

SNA satin aluminum +\$10

SNB satin bronze +\$10

SNC satin carbon +\$10

WL sandstone +\$0

WN warm grey neutral +\$0

Step 7. Fabric

Price Category 1 +\$0

Price Category 2 +\$20

Price Category 3 +\$48

Price Category 4 +\$84

Price Category 5 +\$102

Price Category B +\$378

Price Category C +\$128

Price Category E +\$203

Flat Edge Screen, Surface Attached

FT356.

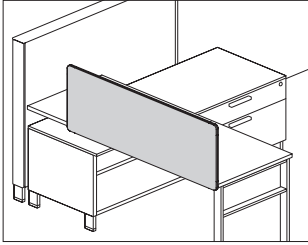

Product Information

Description

This tackable fabric screen attaches to a Canvas work surface to provide boundary with a tackable surface. Attachment hardware included.

Notes

Screen heights are overall datum heights to align with Canvas Office Landscape®; they are not the actual heights of screens.

42"-high (42) screen is a nominal 13" above work surface.

46"-high (46) screen is a nominal 17" above work surface.

53"-high (53) screen is a nominal 24" above work surface.

Screen widths are actual dimensions, and extend to the end of Canvas work surfaces.

Screen extends 4" below surface to hide attachment hardware.

Screen can be flush with back edge of surface, or provide a 1" gap.

Screens 48" wide and wider include an additional 1"-wide center mounting bracket.

Screen accepts Customer's Own Material (COM). Yardage is estimated for nondirectional 54"-wide fabrics.

For vertical fabric direction (T):

Height—Yardage

42—1.49

46—1.73

53—2.18

For horizontal fabric direction (R):

Width—Yardage

40—1.34

42—1.51

46—1.62

48—1.71

52—1.81

54—1.90

60—2.07

66—2.27

72—2.46

For information on multiple quantities or directional fabrics, contact COM Department. See Order Information in Appendices.

Dimensions

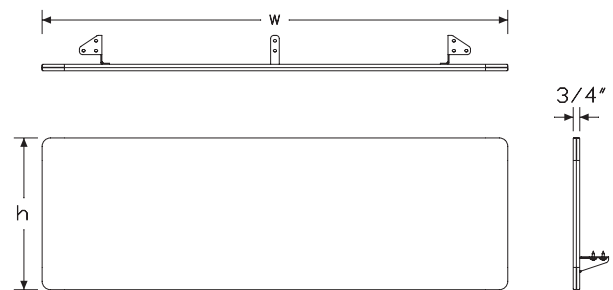

Flat Edge Screen, Surface Attached *continued*

Specification Information

Step 1.

FT356.

Step 2. Attachment

C Canvas surface attached

Step 3. Height

42 42" high

46 46" high

53 53" high

Step 4. Width

40 39½" wide

42 42" wide

46 45½" wide

48 48" wide

52 51½" wide

54 54" wide

60 60" wide

66 66" wide

72 72" wide

Step 5. Surface Material

For 39½" wide (40), 42" wide (42), 45½" wide (46), or 48" wide (48)

R tackable fabric, horizontal

T tackable fabric

For 51½" wide (52), 54" wide (54), 60" wide (60), 66" wide (66), or 72" wide (72)

R tackable fabric, horizontal

Prices for Steps 1-5.

		40R	40T	42R	42T	46R	46T
FT356. C	42	\$782	782	798	798	834	834
	46	\$843	843	881	881	911	911
	53	\$1091	1091	1196	1196	1211	1211

		48R	48T	52R	54R	60R	66R
FT356. C	42	\$853	853	880	905	980	1026
	46	\$972	972	1002	1063	1151	1202
	53	\$1233	1233	1247	1266	1300	1307

		72R
FT356. C	42	\$1091
	46	\$1256
	53	\$1315

Step 6. Bracket Finish

G2 graphite satin +\$0

Step 7. Fabric

For 39½" wide (40), 42" wide (42), 45½" wide (46), or 48" wide (48)

Price Category B +\$132

Price Category 1 +\$0

Price Category 2 +\$28

Price Category 3 +\$65

Price Category 4 +\$113

Price Category 5 +\$166

Price Category C +\$161

Price Category E +\$203

For 51½" wide (52), 54" wide (54), 60" wide (60), 66" wide (66), or 72" wide (72)

Price Category B +\$132

Price Category 1 +\$0

Price Category 2 +\$32

Price Category 3 +\$78

Price Category 4 +\$136

Price Category 5 +\$188

Price Category C +\$198

Price Category E +\$203

Flat Edge Screen, Surface Attached with Modesty

FT357.

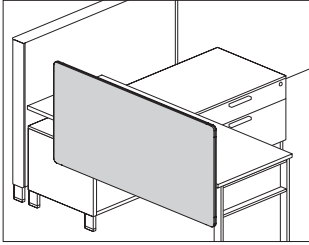

Product Information

Description

This tackable fabric screen attaches to a Canvas work surface to provide boundary and modesty with a tackable surface. An optional cable management trough is available. Trough finish is graphite. Attachment hardware included.

Notes

Screen heights are overall datum heights to align with Canvas Office Landscape®; they are not the actual heights of screens.

42"-high (A42) screen is a nominal 13" above work surface.

46"-high (A46) screen is a nominal 17" above work surface.

53"-high (A53) screen is a nominal 24" above work surface.

Screen widths are actual dimensions, and extend to the end of Canvas work surfaces.

Screen extends 9" below surface for modesty.

Screen can be flush with back edge of surface, or provide a 1" gap.

Screens 48" wide and wider include an additional 1"-wide center mounting bracket.

Screen accepts Customer's Own Material (COM). Yardage is estimated for nondirectional 54"-wide fabrics.

For vertical fabric direction (T):

Height—Yardage

42—1.90

46—2.14

53—2.59

For horizontal fabric direction (R):

Width—Yardage

40—2.87

42—3.02

46—3.22

48—3.41

52—3.63

54—3.78

60—4.17

66—4.54

72—4.92

For information on multiple quantities or directional fabrics, contact COM Department. See Order Information in Appendices.

Dimensions

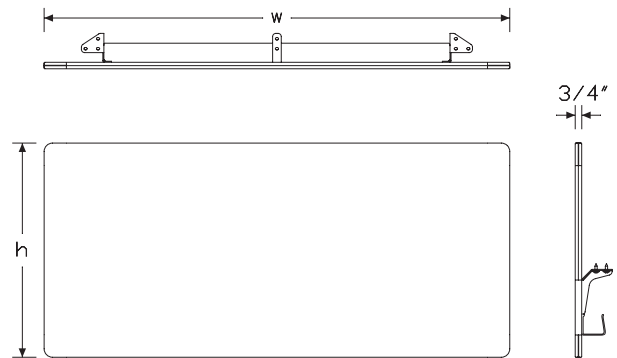

Flat Edge Screen, Surface Attached with Modesty *continued*

Specification Information

Step 1.

FT357.

Step 2. Attachment

C Canvas surface attached

Step 3. Height

A42 42" high/9" below surface

A46 46" high/ 9" below surface

A53 53" high/ 9" below surface

Step 4. Width

40 39½" wide

42 42" wide

46 45½" wide

48 48" wide

52 51½" wide

54 54" wide

60 60" wide

66 66" wide

72 72" wide

Step 5. Surface Material

For 39½" wide (40), 42" wide (42), 45½" wide (46), or 48" wide (48)

R tackable fabric, horizontal

T tackable fabric

For 51½" wide (52), 54" wide (54), 60" wide (60), 66" wide (66), or 72" wide (72)

R tackable fabric, horizontal

Prices for Steps 1-5.

		40R	40T	42R	42T	46R	46T
FT357. C	A42	\$843	843	881	881	917	917
	A46	\$1012	1012	1080	1080	1084	1084
	A53	\$1208	1208	1236	1236	1242	1242
		48R	48T	52R	54R	60R	66R
FT357. C	A42	\$931	931	974	979	1077	1105
	A46	\$1095	1095	1135	1188	1204	1238
	A53	\$1254	1254	1260	1268	1288	1396

72R

FT357. C A42 \$1182

A46 \$1280

A53 \$1442

Step 6. Cable Trough

NC no cable way +\$0

CW cable way +\$25

Step 7. Cable Trough Finish

G2 graphite satin +\$0

Step 8. Bracket Finish

G2 graphite satin +\$0

Step 9. Fabric

For 39½" wide (40), 42" wide (42), 45½" wide (46), or 48" wide (48)

Price Category B +\$151

Price Category 1 +\$0

Price Category 2 +\$43

Price Category 3 +\$103

Price Category 4 +\$180

Price Category 5 +\$260

Price Category C +\$356

Price Category E +\$539

For 51½" wide (52), 54" wide (54), 60" wide (60), 66" wide (66), or 72" wide (72)

Price Category B +\$262

Price Category 1 +\$0

Price Category 2 +\$62

Price Category 3 +\$148

Price Category 4 +\$257

Price Category 5 +\$380

Price Category C +\$515

Price Category E +\$778

Everywhere™ Screens

Flat Edge Screen, Delineation

FT358.

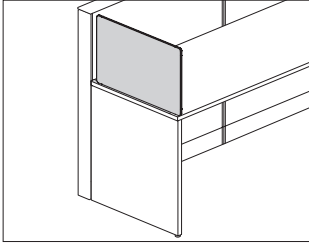

Product Information

Description

This tackable fabric screen attaches to a work surface at the right or left edge to provide division and boundary between workers. It attaches with no interference from supports below the work surface. Attachment hardware included.

Notes

Screen height is 13¹/₂" or 17¹/₂" above work surface, aligning with bead heights of 41" and 45".

Screen width matches work surface depths that have a 1" gap at the back edge.

2 attachment methods ship with the end-of-run right handed (CR) and end-of-run left handed (CL) screen. The screen can be installed using the bracket, or using threaded screws that drill bayonets directly into the surface. See planning guide for exact location of holes.

End-of-run screen does not work on Canvas Beam.

See planning guide for applications and other compatible product lines.

Screen accepts Customer's Own Material (COM). Yardage is estimated for nondirectional 54"-wide fabrics.

For vertical fabric direction (T):

Height—Yardage

42—1.19

46—1.45

For horizontal fabric direction (R):

Width—Yardage

24—0.90

30—1.10

36—1.30

For information on multiple quantities or directional fabrics, contact COM Department. See Order Information in Appendices.

Dimensions

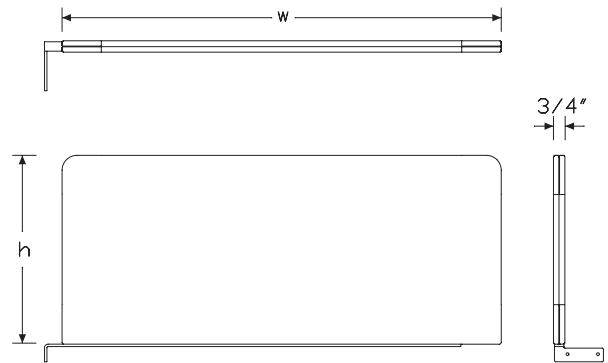

Flat Edge Screen, Delineation

continued

Specification Information

Step 1.

FT358.

Step 2. Attachment Type

CL Canvas Surface Attached, End of Run Left Handed

CR Canvas Surface Attached, End of Run Right Handed

Step 3. Height

42 42" high

46 46" high

Step 4. Width

24 24" wide

30 30" wide

36 36" wide

Step 5. Surface Material

R tackable fabric, horizontal

T tackable fabric

Prices for Steps 1-5.

	24R	24T	30R	30T	36R	36T
FT358. CL 42	\$685	685	724	724	738	738
46	\$745	745	789	789	816	816
CR 42	\$685	685	724	724	738	738
46	\$745	745	789	789	816	816

Step 6. Bracket Finish

8Q folkstone grey +\$0

91 white +\$0

98 studio white +\$0

BK black +\$0

G1 graphite +\$0

SNA satin aluminum +\$10

SNB satin bronze +\$10

SNC satin carbon +\$10

WL sandstone +\$0

WN warm grey neutral +\$0

Step 7. Fabric

Price Category 1 +\$0

Price Category 2 +\$20

Price Category 3 +\$48

Price Category 4 +\$84

Price Category 5 +\$140

Price Category B +\$68

Price Category C +\$122

Price Category E +\$203

Laminate Screen, Surface Attached

FT360.

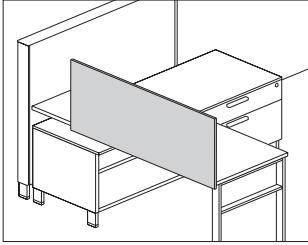

Product Information

Description

This laminate screen attaches to a Canvas work surface to provide boundary. Attachment hardware included.

Notes

Screen widths are actual dimensions; screens extend to the ends of Canvas work surfaces.

Screen extends 4" below surface to hide attachment hardware.

Screen can be flush with back edge of surface, or provide a 1" gap.

Screens 48" wide and wider include an additional 1"-wide center mounting bracket.

Dimensions

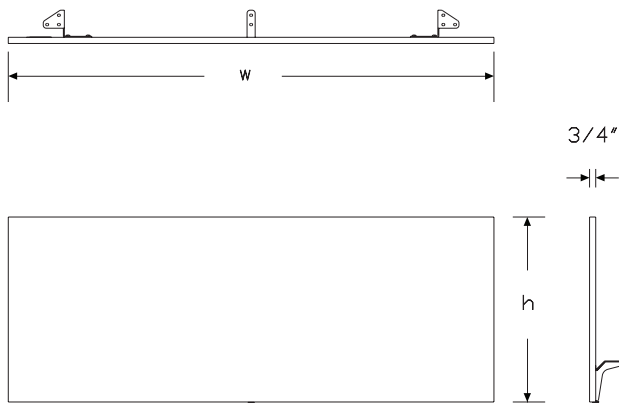

Everywhere™ Screens

Specification Information

Step 1.

FT360.

Step 2. Attachment

C Canvas surface attached

Step 3. Height

42 42" high

46 46" high

Step 4. Width

39A 39½" wide

42 42" wide

45A 45½" wide

48 48" wide

51A 51½" wide

54 54" wide

60 60" wide

66 66" wide

72 72" wide

Step 5. Surface Material

L thermally-fused laminate

U thermally-fused laminate/universal edge

Prices for Steps 1-5.

		39AL	39AU	42L	42U	45AL	45AU
FT360. C	42	\$480	480	490	490	503	503
	46	\$592	592	604	604	615	615
		48L	48U	51AL	51AU	54L	54U
FT360. C	42	\$516	516	530	530	540	540
	46	\$629	629	640	640	654	654
		60L	60U	66L	66U	72L	72U
FT360. C	42	\$553	553	599	599	630	630
	46	\$664	664	717	717	746	746

Step 6. Grain Direction

For 39½" wide (39A), 42" wide (42), 45½" wide (45A), 48" wide (48), 51½" wide (51A), 54" wide (54), or 60" wide (60)

VTG	vertical grain	+\$0
HRG	horizontal grain	+\$0

Laminate Screen, Surface Attached *continued*

For 66" wide (66) or 72" wide (72)

HRG horizontal grain +\$0

Step 7. Bracket Finish

G2 graphite satin +\$0

Step 8. Surface Finish

76 light brown walnut +\$0
8Q folkstone grey +\$0
91 white +\$0
98 studio white +\$0
CL cool grey neutral +\$0
HM natural maple +\$0
HP light anigre +\$0
HX aged cherry +\$0
LBA clear on ash +\$0
LBB oak on ash +\$0
LBC walnut on ash +\$0
LBF neutral twill +\$0
LBJ graphite twill +\$0
LBQ white twill +\$0
LBR phantom ecru +\$0
LBS phantom cocoa +\$0
LBU medium matte walnut +\$0
LBV warm grey teak +\$0
LU soft white +\$0
WL sandstone +\$0
WN warm grey neutral +\$0

Step 9. Edge Finish

For thermally-fused laminate (L)

76 light brown walnut +\$0
8Q folkstone grey +\$0
91 white +\$0
98 studio white +\$0
BU black umber +\$0
CL cool grey neutral +\$0
HF inner tone light +\$0
HM natural maple +\$0
HP light anigre +\$0
HX aged cherry +\$0
LBA clear on ash +\$0
LBR phantom ecru +\$0
LBS phantom cocoa +\$0
LBU medium matte walnut +\$0
LBV warm grey teak +\$0
LBB oak on ash +\$0
LBC walnut on ash +\$0
LBF neutral twill +\$0
LBJ graphite twill +\$0
LBQ white twill +\$0
LU soft white +\$0
WL sandstone +\$0
WN warm grey neutral +\$0

For thermally-fused laminate/universal edge (U)

PLY plywood edge +\$50

Laminate Screen, Surface Attached with Modesty

FT361.

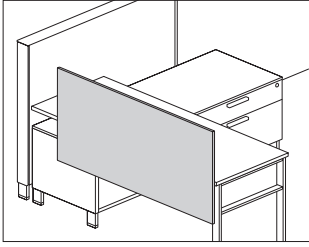

Product Information

Description

This laminate screen attaches to a Canvas work surface to provide boundary and modesty. An optional cable management trough is available. Trough finish is graphite. Attachment hardware included.

Notes

Screen widths are actual dimensions; screens extend to the ends of Canvas work surfaces.

Screen extends 9" below surface for modesty.

Screen can be flush with back edge of surface, or provide a 1" gap.

Screens 48" wide and wider include an additional 1"-wide center mounting bracket.

Dimensions

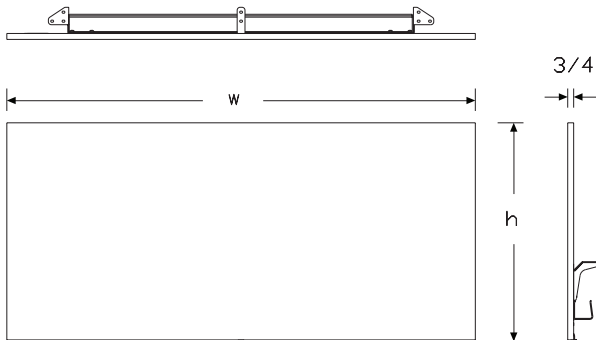

Everywhere™ Screens

Specification Information

Step 1.

FT361.

Step 2. Attachment

C Canvas surface attached

Step 3. Height

A42 42" high/9" below surface

A46 46" high/ 9" below surface

Step 4. Width

39A 39½" wide

42 42" wide

45A 45½" wide

48 48" wide

51A 51½" wide

54 54" wide

60 60" wide

66 66" wide

72 72" wide

Step 5. Surface Material

L thermally-fused laminate

U thermally-fused laminate/universal edge

Prices for Steps 1-5.

		39AL	39AU	42L	42U	45AL	45AU
FT361. C	A42	\$518	518	533	533	545	545
	A46	\$641	641	657	657	669	669
		48L	48U	51AL	51AU	54L	54U
FT361. C	A42	\$560	560	571	571	585	585
	A46	\$682	682	694	694	707	707
		60L	60U	66L	66U	72L	72U
FT361. C	A42	\$598	598	642	642	671	671
	A46	\$721	721	769	769	796	796

Step 6. Grain Direction

For 39½" wide (39A), 42" wide (42), 45½" wide (45A), 48" wide (48), 51½" wide (51A), 54" wide (54), or 60" wide (60)

VTG	vertical grain	+\$0
HRG	horizontal grain	+\$0

Laminate Screen, Surface Attached with Modesty *continued*

For 66" wide (66) or 72" wide (72)

HRG horizontal grain +\$0

Step 7. Cable Way

CW cable way +\$25
NC no cable way +\$0

Step 8. Cable Way Finish

For cable way (CW)
G2 graphite satin +\$0

Step 9. Bracket Finish

G2 graphite satin +\$0

Step 10. Surface Finish

76 light brown walnut +\$0
8Q folkstone grey +\$0
91 white +\$0
98 studio white +\$0
CL cool grey neutral +\$0
HM natural maple +\$0
HP light anigre +\$0
HX aged cherry +\$0
LBA clear on ash +\$0
LBB oak on ash +\$0
LBC walnut on ash +\$0
LBF neutral twill +\$0
LBJ graphite twill +\$0
LBQ white twill +\$0
LBR phantom ecru +\$0
LBS phantom cocoa +\$0
LBU medium matte walnut +\$0
LBV warm grey teak +\$0
LU soft white +\$0
WL sandstone +\$0
WN warm grey neutral +\$0

Step 11. Edge Finish

For thermally-fused laminate (L)

76 light brown walnut +\$0
8Q folkstone grey +\$0
91 white +\$0
98 studio white +\$0
BU black umber +\$0
CL cool grey neutral +\$0
HF inner tone light +\$0
HM natural maple +\$0
HP light anigre +\$0
HX aged cherry +\$0
LBA clear on ash +\$0
LBR phantom ecru +\$0
LBS phantom cocoa +\$0
LBU medium matte walnut +\$0
LBV warm grey teak +\$0
LBB oak on ash +\$0
LBC walnut on ash +\$0
LBF neutral twill +\$0
LBJ graphite twill +\$0
LBQ white twill +\$0
LU soft white +\$0
WL sandstone +\$0
WN warm grey neutral +\$0

For thermally-fused laminate/universal edge (U)

PLY plywood edge +\$50

Metal Straight Screen, Surface Attached with Modesty YT250.

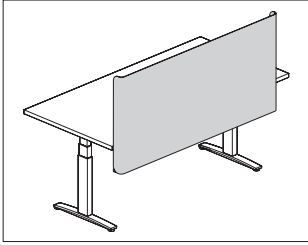

Product Information

Description

This metal screen attaches to an individual table, desk, stationary or height-adjustable work surface. It has a frameless all-metal design with a straight edge and includes a modesty panel. Screen has built-in ledge to support documents when used with the magnetic document clip. Screen accepts magnets. Attachment hardware included.

Notes

Screen top edge is 11.375" above top of work surface; bottom edge is 3.8" below work surface.

Recommended mounting creates a 1" gap between back edge of surface and the screen to accommodate cable routing and the attachment or clamp-mounting of other hardware to the surface.

Attachment brackets are inset from edge of screen by approximately 6 1/2" and require 2 1/2" of work surface for attachment.

Attachment bracket finish matches specified screen finish.

Order magnetic document clip (YT400.) separately.

Dimensions

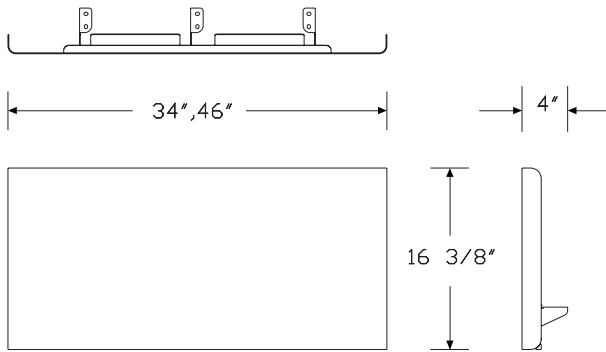

Specification Information

Step 1.

YT250.

Step 2. Height

A 11" high

Step 3. Width

34 34" wide

46 46" wide

Prices for Steps 1-3.

	34	46
YT250. A	\$422	449

Step 4. Screen Finish

SNB	satin bronze	+\$10
91	white	+\$0
98	studio white	+\$0
G1	graphite	+\$0
MS	metallic silver	+\$0

Modesty Panel

Y1113.

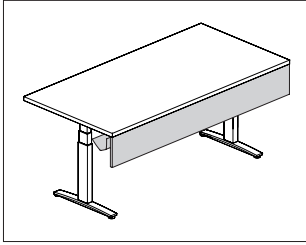

Product Information

Description

This modesty panel attaches to a table, desk, peninsula, or work surface. It has a solid MDF core with a laminate or veneer surface, aluminum top rail and attachment brackets. Cable trough is optional. Attachment hardware included.

Notes

Specify modesty panel to be equal to surface width, or 6" less than surface width of a height adjustable table.

Modesty panel dimension is approximately 10" high with width specified in step 1. Actual width 1/4" less than specified value.

Modesty panel is field installed.

Brackets are located to work with Connect™ 2-circuit power system.

Modesty panel (Y1113.) may impede ideal folding functionality of flip top table (DT5Ax.). For use with flip top table, modesty panel (Y1114.) is recommended. It comes only with a fabric surface.

Dimensions

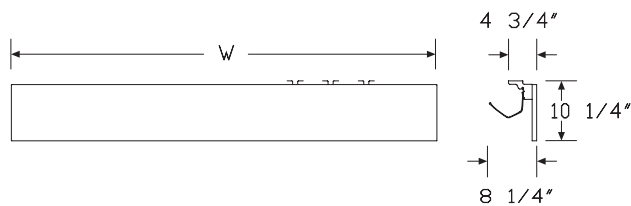

Specification Information

Step 1.

Y1113.

Step 2. Width

24	24" wide
30	30" wide
36	36" wide
42	42" wide
48	48" wide
54	54" wide
60	60" wide
66	66" wide
72	72" wide

Step 3. Cable Trough

N	without added cable trough
Y	with added cable trough

Step 4. Surface Material

L	thermally-fused laminate top/thermoplastic edge
W	veneer top/veneer edge

Prices for Steps 1-4.

	L	W
Y1113. 24 N	\$267	472
Y	\$474	699
30 N	\$291	529
Y	\$537	800
36 N	\$317	587
Y	\$583	880
42 N	\$343	645
Y	\$641	972
48 N	\$368	705
Y	\$700	1068
54 N	\$396	764
Y	\$761	1160
60 N	\$421	820
Y	\$820	1252
66 N	\$421	877
Y	\$879	1345
72 N	\$455	935
Y	\$936	1437

Step 5. Finish

For thermally-fused laminate top/thermoplastic edge (L)

76	light brown walnut	+\$0
8Q	folkstone grey	+\$0
91	white	+\$0
98	studio white	+\$0
CL	cool grey neutral	+\$0
G1	graphite	+\$0
HM	natural maple	+\$0
HP	light anigre	+\$0
HX	aged cherry	+\$0
LBA	clear on ash	+\$0
LBB	oak on ash	+\$0
LBC	walnut on ash	+\$0
LBF	neutral twill	+\$0
LBJ	graphite twill	+\$0
LBQ	white twill	+\$0
LBR	phantom ecru	+\$0
LBS	phantom cocoa	+\$0
LBU	medium matte walnut	+\$0
LBV	warm grey teak	+\$0
LU	soft white	+\$0
WL	sandstone	+\$0
WN	warm grey neutral	+\$0

For veneer top/veneer edge (W)

2U	light brown walnut	+\$0
40	dark brown walnut	+\$0
UL	natural maple	+\$0

Step 6. Edge Finish

For thermally-fused laminate top/thermoplastic edge (L)

76	light brown walnut	+\$0
8Q	folkstone grey	+\$0
91	white	+\$0
98	studio white	+\$0
BU	black umber	+\$0
CL	cool grey neutral	+\$0
G2	graphite satin	+\$0
HF	inner tone light	+\$0
HM	natural maple	+\$0
HP	light anigre	+\$0
HX	aged cherry	+\$0
LBA	clear on ash	+\$0
LBB	oak on ash	+\$0
LBC	walnut on ash	+\$0
LBF	neutral twill	+\$0
LBJ	graphite twill	+\$0
LBQ	white twill	+\$0
LBR	phantom ecru	+\$0
LBS	phantom cocoa	+\$0
LBU	medium matte walnut	+\$0
LBV	warm grey teak	+\$0
LU	soft white	+\$0
WL	sandstone	+\$0
WN	warm grey neutral	+\$0

Pari Screen, Surface Attached with Modesty FT353.

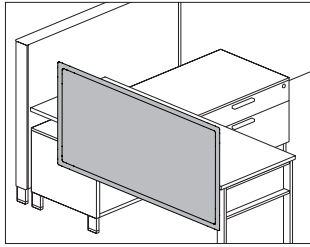

Product Information

Description

This tackable fabric screen attaches to a Canvas work surface to provide boundary and modesty with a tackable surface. An optional cable management trough is available. Trough finish is graphite. Attachment hardware included.

Notes

Screen widths are actual dimensions, and extend to the end of Canvas work surfaces.

Screen extends 10" below surface for modesty.

Screen can be flush with back edge of surface, or provide a 1" gap.

Screens 48" wide and wider include an additional 1"-wide center mounting bracket.

Screen accepts Customer's Own Material (COM). Yardage is estimated for nondirectional 54"-wide fabrics.

For vertical fabric direction (T):

Height—Yardage

42—1.90

46—2.14

53—2.59

For horizontal fabric direction (R):

Width—Yardage

40—2.87

42—3.02

46—3.22

48—3.41

52—3.63

54—3.78

60—4.17

66—4.54

72—4.92

For information on multiple quantities or directional fabrics, contact COM Department. See Order Information in Appendices.

Dimensions

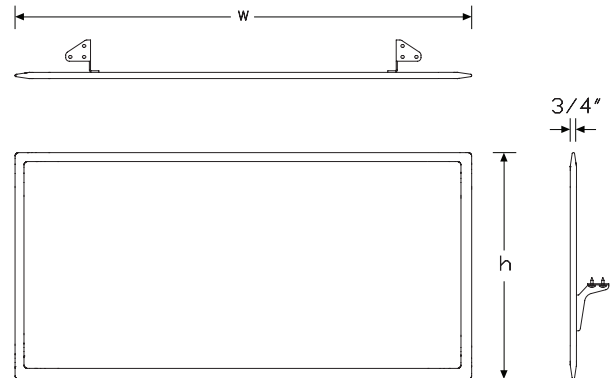

Everywhere™ Screens

Pari Screen, Surface Attached with Modesty *continued*

Everywhere™ Screens

Specification Information

Step 1.

FT353. A

Step 2. Attachment

C Canvas surface attached A

Step 3. Height

A42 42" high/10" below surface A

A46 46" high/10" below surface A

A53 53" high/10" below surface A

Step 4. Width

40 39½" wide A

42 42" wide A

46 45½" wide A

48 48" wide A

52 51½" wide A

54 54" wide A

60 60" wide A

66 66" wide A

72 72" wide A

Step 5. Surface Material

For 39½" wide (40), 42" wide (42), 45½" wide (46), or 48" wide (48)

R tackable fabric, horizontal A

T tackable fabric A

For 51½" wide (52)

R tackable fabric, horizontal A

For 54" wide (54), 60" wide (60), 66" wide (66), or 72" wide (72)

R tackable fabric, horizontal A

Prices for Steps 1-5.

		40R	40T	42R	42T	46R	46T
FT353. C	A42	\$1088	1088	1123	1123	1237	1237
	A46	\$1249	1249	1319	1319	1373	1373
	A53	\$1436	1436	1461	1461	1555	1555
		48R	48T	52R	54R	60R	66R
FT353. C	A42	\$1249	1249	1375	1406	1436	1548
	A46	\$1417	1417	1471	1485	1573	1653
	A53	\$1573	1573	1608	1629	1684	1828

72R

FT353. C	A42	\$1591
	A46	\$1692
	A53	\$1861

Step 6. Cable Trough

NC no cable way A +\$0

CW cable way A +\$25

Step 7. Cable Trough Finish

G2 graphite satin A +\$0

Step 8. Bracket Finish

G2 graphite satin A +\$0

Step 9. Fabric

For 39½" wide (40), 42" wide (42), 45½" wide (46), or 48" wide (48)

Price Category B	+\$244
Price Category 1	+\$0
Price Category 2	+\$43
Price Category 3	+\$103
Price Category 4	+\$180
Price Category 5	+\$0
Price Category C	+\$336
Price Category E	+\$509

For 51½" wide (52), 54" wide (54), or 60" wide (60)

Price Category B	+\$322
Price Category 1	+\$0
Price Category 2	+\$62
Price Category 3	+\$148
Price Category 4	+\$257
Price Category 5	+\$0
Price Category C	+\$436
Price Category E	+\$659

For 66" wide (66) or 72" wide (72)

Price Category B	+\$378
Price Category 1	+\$0
Price Category 2	+\$77
Price Category 3	+\$185
Price Category 4	+\$320
Price Category 5	+\$0
Price Category C	+\$436
Price Category E	+\$659

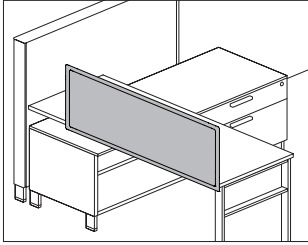

Product Information

Description

This tackable fabric screen attaches to a Canvas work surface to provide boundary with a tackable surface. Attachment hardware included.

Notes

Screen widths are actual dimensions, and extend to the end of Canvas work surfaces.

Screen extends 4" below surface to hide attachment hardware.

Screen can be flush with back edge of surface, or provide a 1" gap.

Screens 48" wide and wider include an additional 1"-wide center mounting bracket.

Screen accepts Customer's Own Material (COM). Yardage is estimated for nondirectional 54"-wide fabrics.

For vertical fabric direction (T):

Height—Yardage

42—1.49

46—1.73

53—2.18

For horizontal fabric direction (R):

Width—Yardage

40—1.34

42—1.51

46—1.62

48—1.71

52—1.81

54—1.90

60—2.07

66—2.27

72—2.46

For information on multiple quantities or directional fabrics, contact COM Department. See Order Information in Appendices.

Dimensions

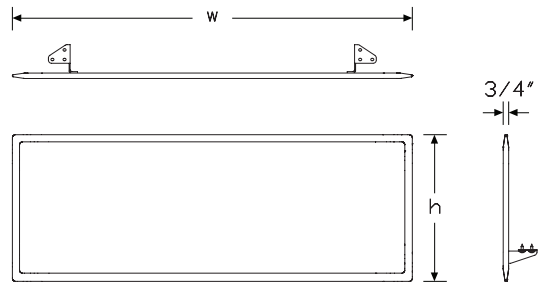

Pari Screen, Surface Attached

continued

Everywhere™ Screens

Specification Information

Step 1.

FT351. A

Step 2. Attachment

C Canvas surface attached A

Step 3. Height

42 42" high A

46 46" high A

53 53" high A

Step 4. Width

40 39½" wide A

42 42" wide A

46 45½" wide A

48 48" wide A

52 51½" wide A

54 54" wide A

60 60" wide A

66 66" wide A

72 72" wide A

Step 5. Surface Material

For 39½" wide (40), 42" wide (42), 45½" wide (46), or 48" wide (48)

R tackable fabric, horizontal A

T tackable fabric A

For 51½" wide (52)

R tackable fabric, horizontal A

For 54" wide (54), 60" wide (60), 66" wide (66), or 72" wide (72)

R tackable fabric, horizontal A

Prices for Steps 1-5.

		40R	40T	42R	42T	46R	46T
FT351. C	42	\$955	955	989	989	1001	1001
	46	\$1033	1033	1071	1071	1123	1123
	53	\$1249	1249	1349	1349	1406	1406

		48R	48T	52R	54R	60R	66R
FT351. C	42	\$1019	1019	1102	1129	1205	1292
	46	\$1181	1181	1261	1292	1386	1461
	53	\$1422	1422	1485	1503	1530	1573

		72R
FT351. C	42	\$1361
	46	\$1517
	53	\$1602

Step 6. Bracket Finish

G2	graphite satin <input type="checkbox"/> A	+\$0
-----------	---	------

Step 7. Fabric

For 39½" wide (40), 42" wide (42), 45½" wide (46), or 48" wide (48)

Price Category B	+\$136
Price Category 1	+\$0
Price Category 2	+\$28
Price Category 3	+\$65
Price Category 4	+\$113
Price Category 5	+\$0
Price Category C	+\$167
Price Category E	+\$281

For 51½" wide (52), 54" wide (54), or 60" wide (60)

Price Category B	+\$160
Price Category 1	+\$0
Price Category 2	+\$32
Price Category 3	+\$78
Price Category 4	+\$136
Price Category 5	+\$0
Price Category C	+\$234
Price Category E	+\$281

For 66" wide (66) or 72" wide (72)

Price Category B	+\$190
Price Category 1	+\$0
Price Category 2	+\$40
Price Category 3	+\$94
Price Category 4	+\$162
Price Category 5	+\$0
Price Category C	+\$234
Price Category E	+\$281

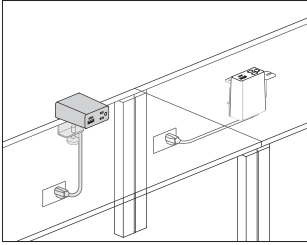

Product Information

Description

This electrical distributor plugs directly into floor, wall, or ceiling drop outlets. Each module configuration presents the same visual appearance. Cable clips and attachment hardware included. Product is UL listed.

Notes

Cable clips for cord management are intended for a 1-time installation.

Clamp versions can be reoriented in the field by a technician.

USB ports provide a combined 20 watts of power to charge most devices and tablets at full speed. USB-C provides 15 watts of power and USB-A provides 10 watts of power individually. When using the USB-C and USB-A ports simultaneously, USB-C remains at 15 watts and USB-A reduces to 5 watts.

Cord color is predetermined. For white (91) finish cords will be white.

For graphite (G1) finish cords will be black.

Grommet mount attachment (Y1414.xxxG) does not come with the mini grommet. Order Logic mini grommet (Y1412.) separately, as needed.

Dimensions

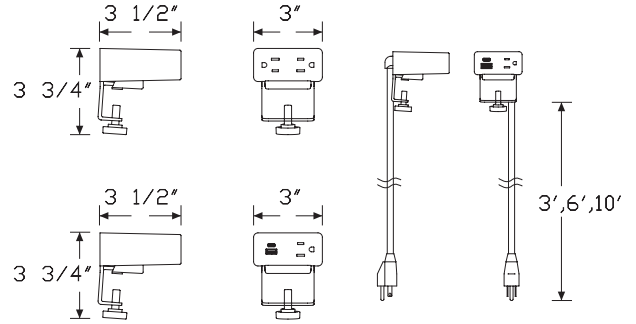

Surface Clamp

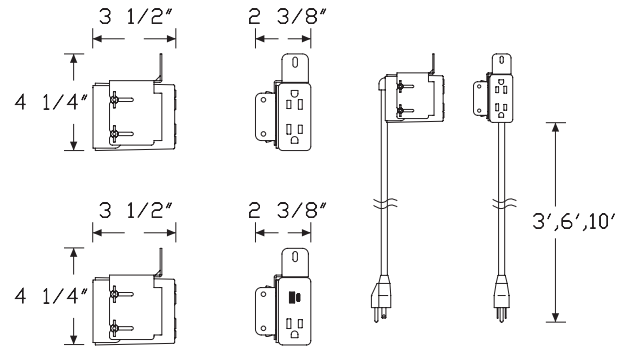

Grommet Mount

Specification Information

Step 1.

Y1414.

Step 2. Configuration

- L** 1 simplex receptacles, 1 powered USB A/C Combo
- K** 2 simplex receptacles

Step 3. Cord/Conduit Length

- 03** 3' cord/conduit
- 06** 6' cord/conduit
- 10** 10' cord/conduit

Step 4. Attachment

- G** grommet mount
- S** surface clamp

Prices for Steps 1-4.

		G	S
Y1414. L	03	\$457	457
	06	\$457	457
	10	\$468	468
	K 03	\$256	256
	06	\$256	256
	10	\$269	269

Step 5. Finish

- BK** black A +\$0
- 91** white A +\$0
- 98** studio white A +\$0
- G1** graphite A +\$0

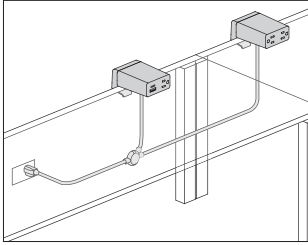

Product Information

Description

This electrical distributor plugs directly into floor, wall, or ceiling drop outlets. Each module configuration presents the same visual appearance. Cable clips and attachment hardware included. Product is ETL listed to UL962.

Notes

Cable clips for cord management are intended for a 1-time installation.

Clamp versions can be reoriented in the field by a technician.

Jumper length denotes distance between center points of each split point.

Cord length denotes distance from plug end to first split point.

Cord color is black for all module finish colors.

All branch lengths from main power cord to module are 12".

USB ports provide a combined 20 watts of power to charge most devices and tablets at full speed. USB-C provides 15 watts of power and USB-A provides 10 watts of power individually. When using the USB-C and USB-A ports simultaneously, USB-C remains at 15 watts and USB-A reduces to 5 watts.

The cord head contains a circuit breaker when there are more than 3 simplex receptacles.

Grommet mount attachment (Y1415.xxxxG) does not come with the mini grommet. Order Logic mini grommet (Y1412.) separately, as needed.

Dimensions

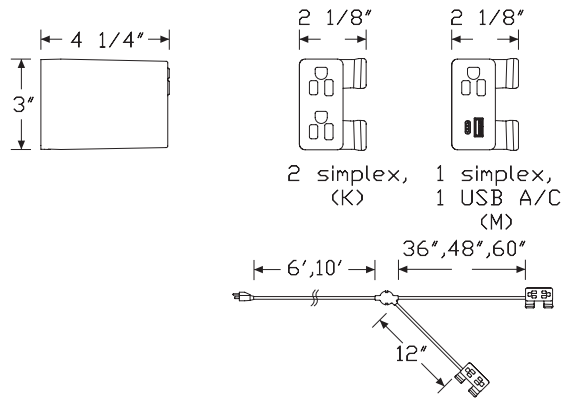

Two Power Modules

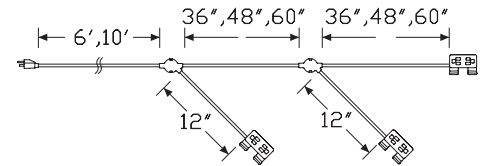

Three Power Modules

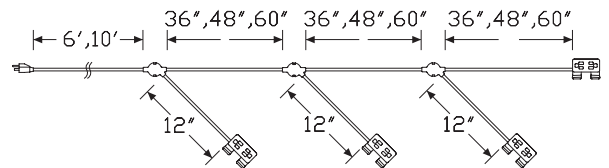

Four Power Modules

Specification Information

Step 1.
Y1415.

Step 2. Number of Modules

- 2** two power modules
- 3** three power modules
- 4** four power modules

Step 3. Power Type

- M** 1 simplex receptacles, 1 powered USB A/C Combo
- K** 2 simplex receptacles, all modules
- N** first module has 1 AC simplex plus 1 powered USB A/C Combo
all other modules have all AC simplexes

Step 4. Jumper Length

- 36** 36" between split points
- 48** 48" between split points
- 60** 60" between split points

Step 5. Attachment

- G** grommet mount
- S** surface clamp

Step 6. Cord/Conduit Length

- 06** 6' cord/conduit
- 10** 10' cord/conduit

Prices for Steps 1-6.

		36G06	36G10	36S06	36S10	48G06	48G10
Y1415.2	M	\$1005	1019	1005	1019	1017	1032
	K	\$604	617	604	617	614	629
	N	\$804	818	804	818	816	830

3	M	\$1497	1510	1497	1510	1518	1533
	K	\$914	931	914	931	939	950
	N	\$1117	1130	1117	1130	1138	1154

4	M	\$2032	2046	2032	2046	2065	2079
	K	\$1229	1240	1229	1240	1262	1273
	N	\$1428	1442	1428	1442	1462	1474

		48S06	48S10	60G06	60G10	60S06	60S10
Y1415.2	M	\$1017	1032	1029	1045	1029	1045
	K	\$614	629	624	639	624	639
	N	\$816	830	828	842	828	842

3	M	\$1518	1533	1542	1555	1542	1555
	K	\$939	950	960	972	960	972
	N	\$1138	1154	1163	1175	1163	1175

4	M	\$2065	2079	2113	2127	2113	2127
	K	\$1262	1273	1292	1309	1292	1309
	N	\$1462	1474	1495	1508	1495	1508

Step 7. Finish

- 91** white A +\$0
- 98** studio white A +\$0
- BK** black A +\$0
- G1** graphite A +\$0

Logic C1000 Universal Clamp Mount Distributor

Y1423.

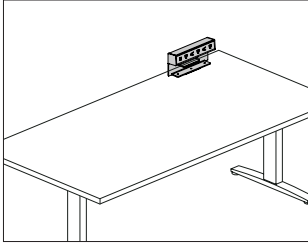

Product Information

Description

This Logic Power Access Solutions™ clamp mounted electrical distributor comes in several widths and configurations of simplex receptacles and USB-A and USB-C charging ports. The unit is powered using a standard power cord with plug end. Data cords can be routed through the integrated opening at the rear of the unit. Product is UL listed.

Notes

Clamp mounts on worksurfaces 1" 1/4" thick.

Faceplate color matches unit color.

Simplex receptacles have alternating orientation and greater than normal plug spacing to accommodate most plug types.

USB ports provide a combined 20 watts of power to charge most devices and tablets at full speed. USB-C provides 15 watts of power and USB-A provides 10 watts of power individually. When using the USB-C and USB-A ports simultaneously, USB-C remains at 15 watts and USB-A reduces to 5 watts.

Dimensions

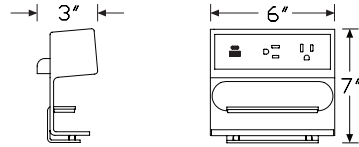

2 simplex receptacles with 1 powered USB A/C combo (H)

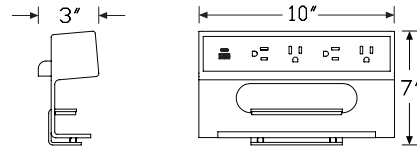

4 simplex receptacles with 1 powered USB A/C combo (I)

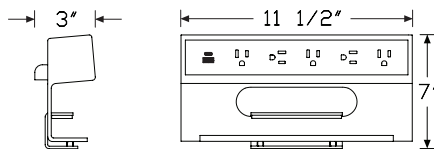

5 simplex receptacles with 1 powered USB A/C combo (J)

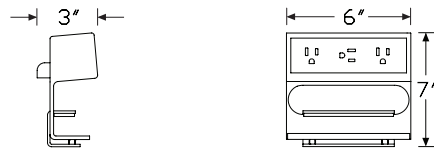

3 simplex receptacles (E)

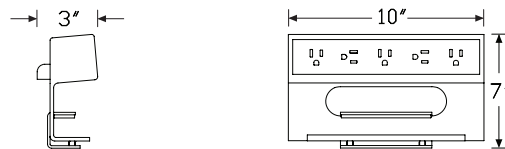

5 simplex receptacles (F)

Logic C1000 Universal Clamp Mount Distributor *continued*

Specification Information

Step 1.

Y1423.

Step 2. Configuration

H	2 simplex receptacles, 1 powered USB A/C Combo
I	4 simplex receptacles, 1 powered USB A/C Combo
J	5 simplex receptacles, 1 powered USB A/C Combo
E	3 simplex receptacles
F	5 simplex receptacles

Step 3. Power Type

A	power cord with plug end
----------	--------------------------

Step 4. Cord/Conduit Length

03	3' cord/conduit
06	6' cord/conduit
10	10' cord/conduit

Prices for Steps 1-4.

		03	06	10
Y1423. H	A	\$614	614	629
	I	\$738	738	750
	J	\$789	789	803
	E	\$412	412	427
	F	\$538	538	550

Step 5. Finish

91	white <input type="checkbox"/>	+\$0
98	studio white <input type="checkbox"/>	+\$0
BK	black <input type="checkbox"/>	+\$0
G1	graphite <input type="checkbox"/>	+\$0
MS	metallic silver <input type="checkbox"/>	+\$0

Everywhere™ Power and Data Support

Logic G1000 Grommet Mounted Electrical Distributor Y1425.

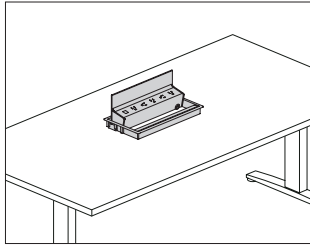

Product Information

Description

This Logic Power Access Solutions™ grommet mounted electrical distributor comes in several widths and configurations of simplex receptacles and USB-A and USB-C charging ports. The unit is powered using a standard power cord with plug end, or an IEC connector when used with Renew™ Sit-to-Stand tables. An integrated cord keeper at the face of the unit captures data cords. The unit pivots from a closed position to 135° allowing easy access to power and data cords stored beneath the unit. Product is UL listed.

Notes

Field cutting of grommet cutout is possible.

IEC connector for Renew power type (C) includes short cord designed to connect to the Renew table power cord through-leg option. Actual cord length may vary.

Simplex receptacles have alternating orientation and greater than normal plug spacing to accommodate most plug types.

USB ports provide a combined 20 watts of power to charge most devices and tablets at full speed. USB-C provides 15 watts of power and USB-A provides 10 watts of power individually. When using the USB-C and USB-A ports simultaneously, USB-C remains at 15 watts and USB-A reduces to 5 watts.

Refer to Renew Sit-to-Stand Tables planning guide for specific application information.

20' cord/conduit length (20) is recommended for Exclave® applications.

Dimensions

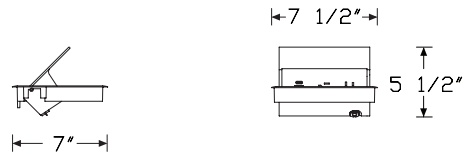

2 simplex receptacles with 1 powered USB A/C combo (H)

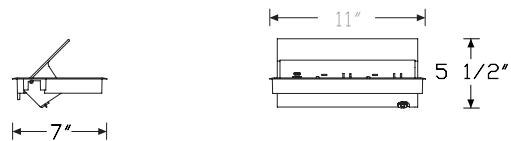

4 simplex receptacles with 1 powered USB A/C combo (I)

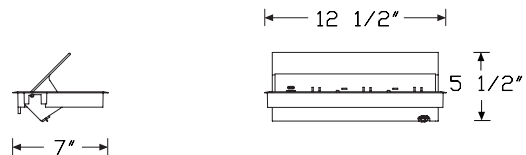

5 simplex receptacles with 1 powered USB A/C combo (J)

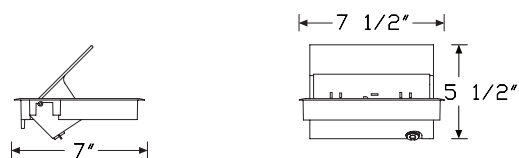

3 simplex receptacles (E)

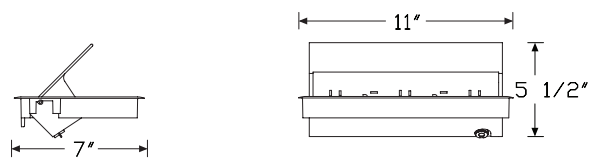

5 simplex receptacles (F)

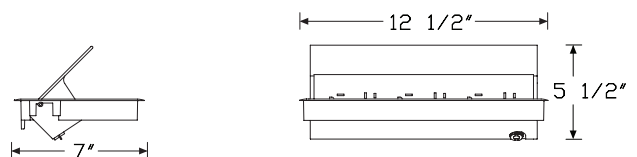

6 simplex receptacles (G)

Logic G1000 Grommet Mounted Electrical Distributor *continued*

Everywhere™ Power and Data Support

Specification Information

Step 1.

Y1425.

Step 2. Configuration

H	2 simplex receptacles, 1 powered USB A/C Combo
I	4 simplex receptacles, 1 powered USB A/C Combo
J	5 simplex receptacles, 1 powered USB A/C Combo
E	3 simplex receptacles
F	5 simplex receptacles
G	6 simplex receptacles

Step 3. Power Type

A	power cord with plug end
C	IEC connector for Renew Tables

Step 4. Cord/Conduit Length

For power cord with plug end (A)

03	3' cord/conduit
06	6' cord/conduit
10	10' cord/conduit
20	20' cord/conduit

For IEC connector for Renew Tables (C)

03	3' cord/conduit
-----------	-----------------

Prices for Steps 1-4.

		03	06	10	20
Y1425. H	A	\$873	873	887	901
	C	\$887	—	—	—
I	A	\$1011	1011	1028	1042
	C	\$1028	—	—	—
J	A	\$1104	1104	1117	1130
	C	\$1117	—	—	—
E	A	\$672	672	685	697
	C	\$685	—	—	—
F	A	\$811	811	826	841
	C	\$826	—	—	—
G	A	\$901	901	914	931
	C	\$914	—	—	—

Step 5. Finish

91	white <input type="checkbox"/> A	+\$0
98	studio white <input type="checkbox"/> A	+\$0
BK	black <input type="checkbox"/> A	+\$0
G1	graphite <input type="checkbox"/> A	+\$0
MS	metallic silver <input type="checkbox"/> A	+\$0

Logic Mini Grommet

Y1412.

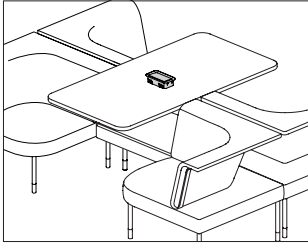

Product Information

Description

This Logic Power Access Solutions™ plastic grommet is available in mini rectangle or mini square configuration. The integrated flaps can hide the things below the surface while also retaining power and data cords.

Notes

This grommet is installed in some HermanMiller applications. Verify your application before ordering grommet separately.

Dimensions

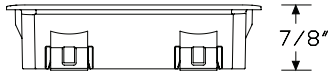
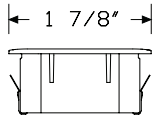
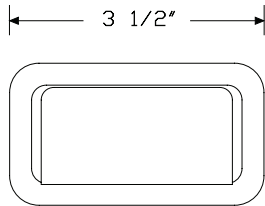

Grommet - Rectangle

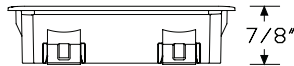
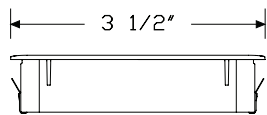
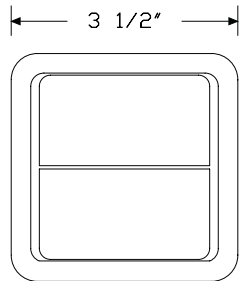

Grommet - Square

Specification Information

Step 1.

Y1412.

Step 2. Configuration

- 1 mini rectangle grommet
- 2 mini square grommet

Prices for Steps 1-2.

Y1412. 1	\$40
2	\$45

Step 3. Finish

91	white	+\$0
98	studio white	+\$0
BK	black	+\$0
G1	graphite	+\$0

Everywhere™ Power and Data Support

Logic G1200 Grommet Pass Thru Y1420.

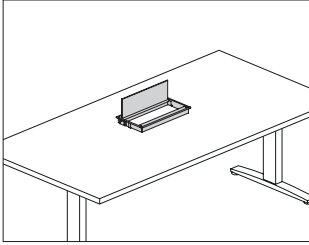

Product Information

Description

This Logic Power Access Solutions™ grommet mounted metal enclosure provides access to cords kept beneath the surface. The unit has an integrated cord keeper.

Notes

Unit size is based on the grommet mounted electrical distributor (Y1425.) with simplex receptacles.

Dimensions

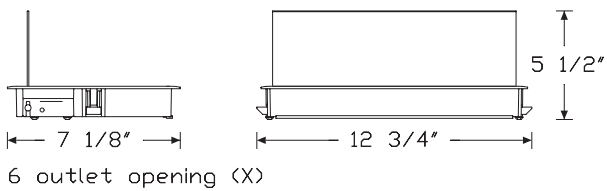
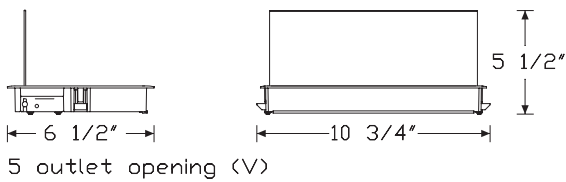
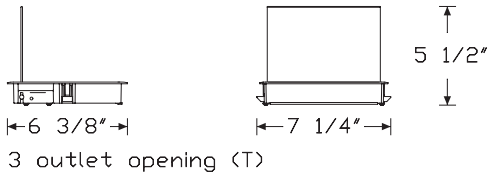

Specification Information

Step 1.

Y1420.

Step 2. Configuration

- T** three outlet opening
- V** five outlet opening
- X** six outlet opening

Prices for Steps 1-2.

Y1420. T	\$294
V	\$323
X	\$351

Step 3. Finish

91 white [A]	+\$0
98 studio white [A]	+\$0
BK black [A]	+\$0
G1 graphite [A]	+\$0
MS metallic silver [A]	+\$0

Everywhere™ Power and Data Support

Conference Table HD Trough

DT9C.

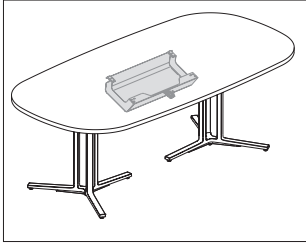

Product Information

Description

This stand-alone painted steel cable management tray mounts to the underside of most conference table surfaces. It can be used with an in-surface grommet mounted unit, providing cord storage under the surface. The tray drops down for access to cords and can be easily stowed back in place.

Notes

Trough widths are optimized to fit on 60", 72", or 84"-wide tables.

Actual trough widths are:

Table Width—Trough Width

- 60"—24"
- 72"—30"
- 84"—42"

Dimensions

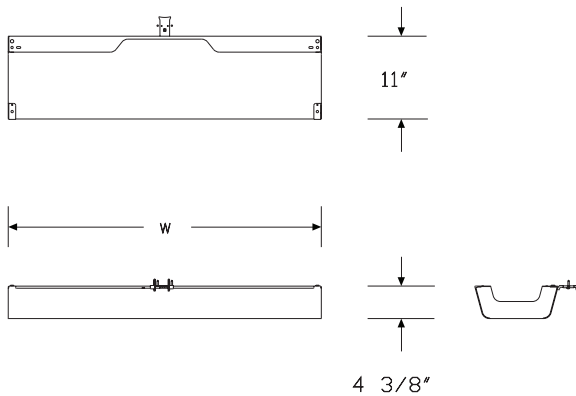

Specification Information

Step 1.

DT9C.

Step 2. Table Width

60	60" wide
72	72" wide
84	84" wide

Prices for Steps 1-2.

DT9C. 60	\$428
72	\$428
84	\$428

Step 3. Finish

Metallic Paint

CN	metallic champagne	+\$0
EH	metallic bronze	+\$0
MS	metallic silver	+\$0

Sand Texture Paint

BK	black	+\$0
-----------	-------	------

Smooth Paint

8Q	folkstone grey	+\$0
91	white	+\$0
98	studio white	+\$0
BU	black umber	+\$0
CL	cool grey neutral	+\$0
G2	graphite satin	+\$0
HF	inner tone light	+\$0
LU	soft white	+\$0
MT	medium tone	+\$0
SG	slate grey	+\$0
WL	sandstone	+\$0
WN	warm grey neutral	+\$0

Everywhere™ Power and Data Support

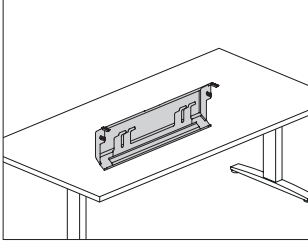

Product Information

Description

This Logic Power Access Solutions™ stand-alone cable management tray mounts to the underside of most surfaces. It can be used with a Logic unit for cord storage, or used alone with cords routed through the back side of the unit. Tray drops down and holds cords in place while working and can be easily stowed back in place.

Dimensions

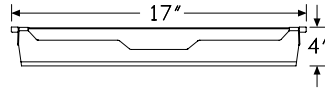
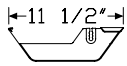

Specification Information

Step 1.

Y1424.

Step 2. Size

17 17" wide tray

Prices for Steps 1-2.

Y1424. 17 \$323

Step 3. Finish

SNA	satin aluminum	+\$0
SNB	satin bronze	+\$0
SNC	satin carbon	+\$0
91	white <input type="checkbox"/> A	+\$0
98	studio white <input type="checkbox"/> A	+\$0
BK	black <input type="checkbox"/> A	+\$0
G1	graphite <input type="checkbox"/> A	+\$0
MS	metallic silver <input type="checkbox"/> A	+\$0

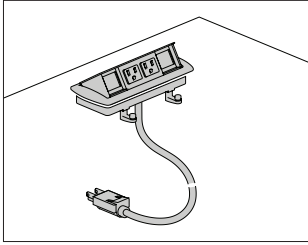

Product Information

Description

This electrical distributor mounts flush in a surface and has a one-touch pop-up mechanism for accessing power and data. It has 2 simplex receptacles and 2 data openings, and is available with a power cord with plug end, or electrical conduit for hardwire connection. A voice/data adapter kit is included, allowing the data openings to accept various manufacturers' couplers and jacks. Attachment hardware and cord/cable clips are also included. Product is UL listed.

Notes

Field cutting of surface may be required. Information on surface cutout size is included on instruction sheet.

Dimensions

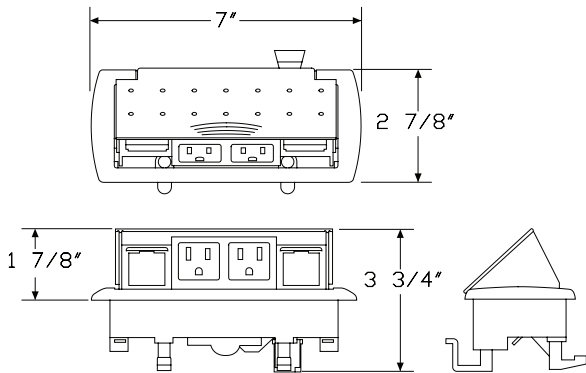

Specification Information

Step 1.

Y1321.

Step 2. Power Type

- A** power cord with plug end
- B** conduit with open end, for hard-wiring

Step 3. Cord/Conduit Length

- 03** 3' cord/conduit
- 06** 6' cord/conduit
- 10** 10' cord/conduit
- 20** 20' cord/conduit

Prices for Steps 1-3.

	03	06	10	20
Y1321. A	\$299	299	312	383
B	\$374	374	389	459

Step 4. Wiring Type

- 4Z** standard +\$0

Step 5. Finish

- 0H** black +\$0

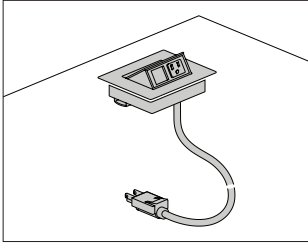

Product Information

Description

This electrical distributor mounts flush in a surface and has a one-touch pop-up mechanism for accessing power and data. It can be configured with 2 simplex receptacles, or 1 simplex receptacle and 1 data opening. The distributor is available with a power cord with plug end, or electrical conduit for hardwire connection. A voice/data adapter kit is included, allowing the data openings to accept various manufacturers' couplers and jacks. Attachment hardware and cord/cable clips are also included. Product is UL listed.

Notes

Field cutting of surface may be required. Information on surface cutout size is included on instruction sheet.

Distributor with PVC-free wiring option (LZ) is Cradle to Cradle Silver Certified.

Distributor with silver finish option (OI) or white finish option (OJ) and standard wiring (4Z) has painted metal trim with white plastic simplex/data interior. Distributor with black finish option (OH) and standard wiring (4Z) has black painted trim with black plastic simplex/data interior. Distributor with PVC-free wiring option (LZ) has black plastic simplex/data interior, regardless of the finish color.

Dimensions

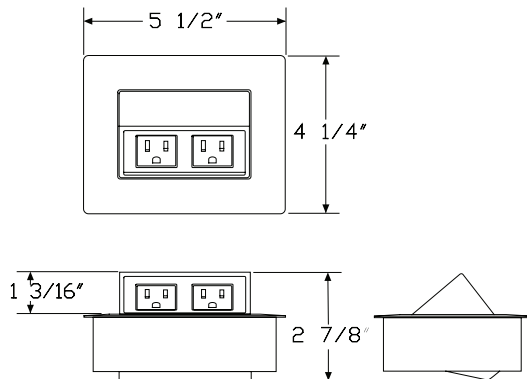

Specification Information

Step 1.

Y1322.

Step 2. Configuration

- 1** 1 simplex receptacle, 1 data opening
- 2** 2 simplex receptacles

Step 3. Power Type

- A** power cord with plug end
- B** conduit with open end, for hard-wiring

Step 4. Cord/Conduit Length

- 03** 3' cord/conduit
- 06** 6' cord/conduit
- 10** 10' cord/conduit
- 20** 20' cord/conduit

Prices for Steps 1-4.

		03	06	10	20
Y1322. 1	A	\$355	355	367	437
	B	\$429	429	441	509
2	A	\$374	374	389	459
	B	\$450	450	465	535

Step 5. Wiring Type

- 4Z** standard +\$0
- LZ** PVC-free +\$39

Step 6. Finish

- OH** black +\$0
- OI** silver +\$0
- OJ** white +\$0

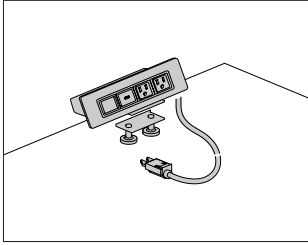

Product Information

Description

This electrical distributor can grommet-mount flush in a surface, or clamp-mount to the edge. It can be configured with several combinations of simplex receptacles, data openings, and USB charging ports. The distributor is available with a power cord with plug end, or electrical conduit for hardwire connection. A voice/data adapter kit is included, allowing the data openings to accept various manufacturers' couplers and jacks. Attachment hardware and cord/cable clips are also included. Product is UL listed.

Notes

Field cutting of surface may be required. Information on surface cutout size is included on instruction sheet.
 Silver option (0I) and white option (0J) have painted metal trim with white plastic simplex/data interiors. Black option (0H) has black painted trim with black plastic simplex/data interior.
 Overall width for distributor with 4 openings is 8" wide. Overall width for distributor with 6 openings is 11" wide.
 USB port charges at 2.1 amps.

Dimensions

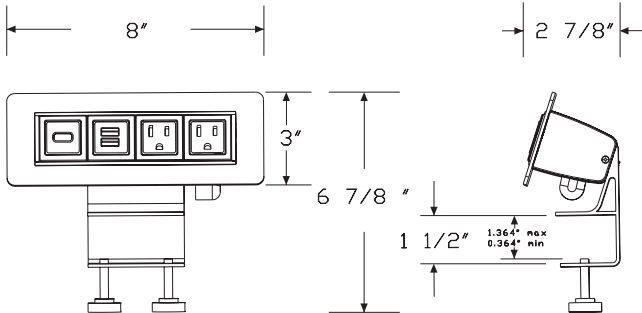

Specification Information

Step 1.

Y1323.

Step 2. Configuration

- 3** 2 simplex receptacles, 2 data openings
- 4** 3 simplex receptacles, 3 data openings
- 5** 2 simplex receptacles, 1 data opening, 1 charging USB port
- 6** 3 simplex receptacles, 2 data opening, 1 charging USB port

Step 3. Power Type

- A** power cord with plug end
- B** conduit with open end, for hard-wiring

Step 4. Cord/Conduit Length

- 03** 3' cord/conduit
- 06** 6' cord/conduit
- 10** 10' cord/conduit
- 20** 20' cord/conduit

Step 5. Attachment

- G** grommet mount
- S** surface clamp

Prices for Steps 1-5.

		03G	03S	06G	06S	10G	10S
Y1323. 3	A	\$402	402	402	402	420	420
	B	\$478	478	478	478	495	495
4	A	\$501	501	501	501	514	514
	B	\$581	581	581	581	595	595
5	A	\$563	563	563	563	579	579
	B	\$642	642	642	642	654	654
6	A	\$661	661	661	661	678	678
	B	\$741	741	741	741	755	755
						20G	20S
Y1323. 3	A					\$489	489
	B					\$561	561
4	A					\$588	588
	B					\$661	661
5	A					\$648	648
	B					\$750	750
6	A					\$745	745
	B					\$853	853

Step 6. Finish		
0H	black	+\$0
0I	silver	+\$0
0J	white	+\$0

Everywhere™ Power and Data Support

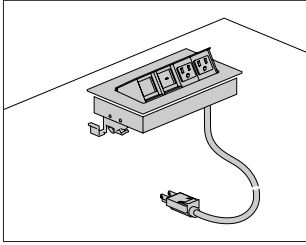

Product Information

Description

This electrical distributor mounts flush in a surface and has a one-touch pop-up mechanism for accessing power and data. It can be configured with several combinations of simplex receptacles, data openings, and USB charging ports. The distributor is available with a power cord with plug end, or electrical conduit for hardwire connection. A voice/data adapter kit is included, allowing the data openings to accept various manufacturers' couplers and jacks. Attachment hardware and cord/cable clips are also included. Product is UL listed.

Notes

Field cutting of surface may be required. Information on surface cutout size is included on instruction sheet.
 Distributor with PVC-free wiring option (LZ) is Cradle to Cradle Silver Certified.
 Distributor with silver anodized finish option (OK) and standard wiring (4Z) has anodized trim with white plastic simplex/data interior.
 Distributor with silver anodized finish option (OK) and PVC-free wiring (LZ) has anodized trim with black plastic simplex/data interior.
 Overall width for distributor with openings is 8 1/4" wide. Overall width for distributor with 7 openings is 12 3/4" wide.
 USB port charges at 2.1 amps.

Dimensions

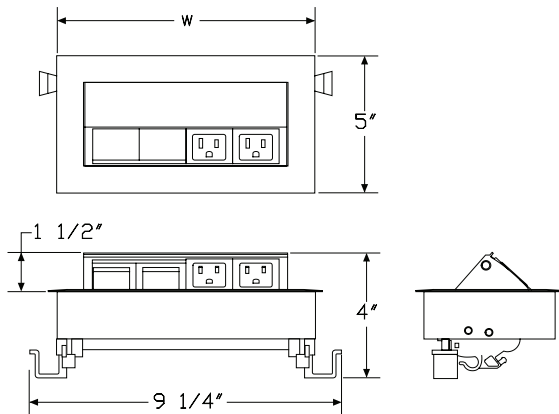

Specification Information

Step 1.

Y1324.

Step 2. Configuration

3	2 simplex receptacles, 2 data openings
5	3 simplex receptacles, 4 data openings
6	2 simplex receptacles, 1 data opening, 1 charging USB port
7	3 simplex receptacles, 3 data opening, 1 charging USB port
8	3 simplex receptacles, 2 data opening, 2 charging USB ports

Step 3. Power Type

A	power cord with plug end
B	conduit with open end, for hard-wiring

Step 4. Cord/Conduit Length

03	3' cord/conduit
06	6' cord/conduit
10	10' cord/conduit
20	20' cord/conduit

Prices for Steps 1-4.

		03	06	10	20
Y1324. 3	A	\$561	561	576	646
	B	\$637	637	654	721
5	A	\$720	720	735	803
	B	\$797	797	806	874
6	A	\$721	721	735	803
	B	\$800	800	814	884
7	A	\$880	880	898	967
	B	\$959	959	970	1037
8	A	\$1041	1041	1055	1126
	B	\$1120	1120	1130	1196

Step 5. Wiring Type

4Z	standard		+\$0
LZ	PVC-free		+\$39

Step 6. Finish

OK	silver anodized		+\$0
-----------	-----------------	--	------

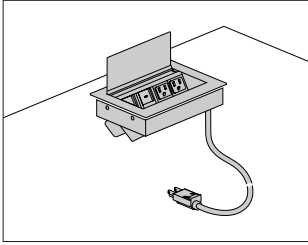

Product Information

Description

This electrical distributor mounts flush in a surface and has a flip-up lid for accessing power and data from above or below the surface. The flip lid can be closed once devices are connected for a clean visual appearance. It can be configured with several combinations of simplex receptacles, data openings, and USB charging ports. The distributor is available with a power cord with plug end, or electrical conduit for hardwire connection. A voice/data adapter kit is included, allowing the data openings to accept various manufacturers' couplers and jacks. Attachment hardware and cord/cable clips are also included. Product is UL listed.

Notes

Field cutting of surface may be required. Information on surface cutout size is included on instruction sheet.

Silver anodized option (OK) has anodized trim with white plastic simplex/data interior.

Overall width for distributor with 4 openings is 8³/₈" wide. Overall width for distributor with 6 openings is 11³/₈" wide.

USB port charges at 2.1 amps.

Dimensions

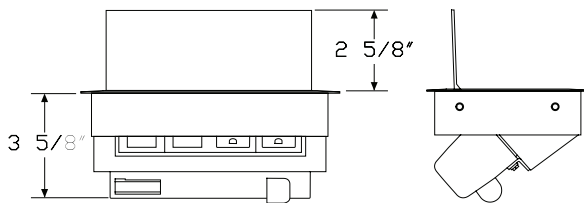
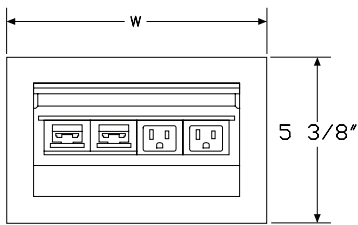

Specification Information

Step 1.

Y1325.

Step 2. Configuration

- 3** 2 simplex receptacles, 2 data openings
- 7** 3 simplex receptacles, 3 data openings
- 5** 2 simplex receptacles, 1 data opening, 1 charging USB port
- 6** 3 simplex receptacles, 2 data opening, 1 charging USB port

Step 3. Power Type

- A** power cord with plug end
- B** conduit with open end, for hard-wiring

Step 4. Cord/Conduit Length

- 03** 3' cord/conduit
- 06** 6' cord/conduit
- 10** 10' cord/conduit
- 20** 20' cord/conduit

Prices for Steps 1-4.

		03	06	10	20
Y1325. 3	A	\$660	660	677	744
	B	\$739	739	750	819
7	A	\$759	759	777	844
	B	\$838	838	852	922
5	A	\$824	824	838	906
	B	\$901	901	913	980
6	A	\$922	922	936	1007
	B	\$998	998	1014	1081

Step 5. Finish

- OK** silver anodized +\$0

Cable Management Clip

DT9A.

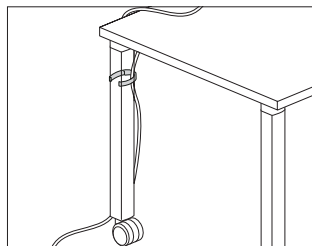

Product Information

Description

This plastic clip snaps onto an Everywhere™ table leg to route cables or cords. Finish is clear. Package of 10.

Dimensions

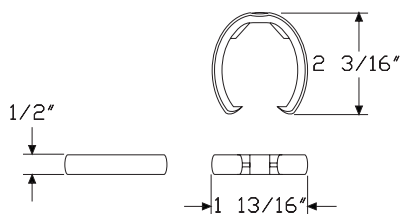

Specification Information

Step 1.

DT9A.

\$57

Vertical Cord Covers

DT9B.

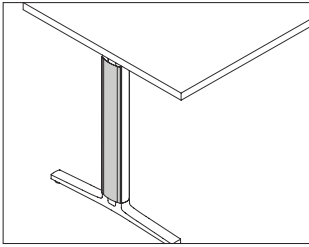

Product Information

Description

These cord covers attach to Everywhere™ table T-leg and Y-leg sections that have either casters or glides. The covers are field installed, and are easily removed and reinstalled for ease of cable management.

Notes

The T cover works with both the (T) and (C) base options.

The Y cover works with both the (E) and (G) base options.

To ensure proper height of the covers, select (C) if your table has casters or select (G) if your table has glides.

Dimensions

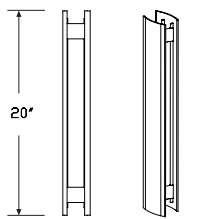

T-leg with casters

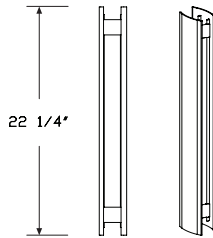

T-leg with glides

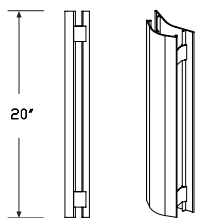

Y-leg with casters

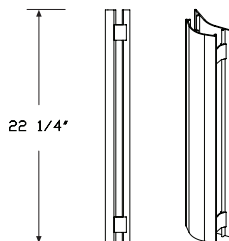

Y-leg with glides

Specification Information

Step 1.

DT9B.

Step 2. Leg Type

- T** T-leg
- E** Y-leg

Prices for Steps 1-2.

DT9B. T	\$379
E	\$379

Step 3. Caster or Glide Table

C	for table with caster base	+\$0
G	for table with glide base	+\$0

Step 4. Leg/Base Finish

Metallic Paint

CN	metallic champagne	+\$0
EH	metallic bronze	+\$0
MS	metallic silver	+\$0
SNA	satin aluminum	+\$30
SNB	satin bronze	+\$30
SNC	satin carbon	+\$30

Sand Texture Paint

BK	black	+\$0
-----------	-------	------

Smooth Paint

8Q	folkstone grey	+\$0
91	white	+\$0
98	studio white	+\$0
BU	black umber	+\$0
CL	cool grey neutral	+\$0
G2	graphite satin	+\$0
HF	inner tone light	+\$0
LU	soft white	+\$0
MT	medium tone	+\$0
SG	slate grey	+\$0
WL	sandstone	+\$0
WN	warm grey neutral	+\$0

Everywhere™ Accessories

Modesty Panel

Y1113.

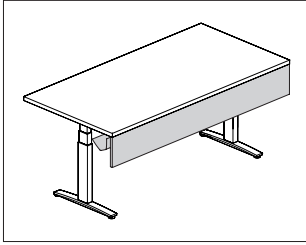

Product Information

Description

This modesty panel attaches to a table, desk, peninsula, or work surface. It has a solid MDF core with a laminate or veneer surface, aluminum top rail and attachment brackets. Cable trough is optional. Attachment hardware included.

Notes

Specify modesty panel to be equal to surface width, or 6" less than surface width of a height adjustable table.

Modesty panel dimension is approximately 10" high with width specified in step 1. Actual width 1/4" less than specified value.

Modesty panel is field installed.

Brackets are located to work with Connect™ 2-circuit power system.

Modesty panel (Y1113.) may impede ideal folding functionality of flip top table (DT5Ax.). For use with flip top table, modesty panel (Y1114.) is recommended. It comes only with a fabric surface.

Dimensions

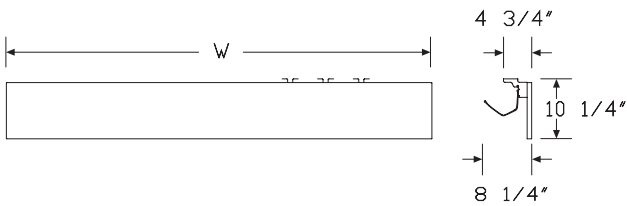

Specification Information

Step 1.

Y1113.

Step 2. Width

24	24" wide
30	30" wide
36	36" wide
42	42" wide
48	48" wide
54	54" wide
60	60" wide
66	66" wide
72	72" wide

Step 3. Cable Trough

N	without added cable trough
Y	with added cable trough

Step 4. Surface Material

L	thermally-fused laminate top/thermoplastic edge
W	veneer top/veneer edge

Prices for Steps 1-4.

	L	W
Y1113. 24 N	\$267	472
Y	\$474	699
30 N	\$291	529
Y	\$537	800
36 N	\$317	587
Y	\$583	880
42 N	\$343	645
Y	\$641	972
48 N	\$368	705
Y	\$700	1068
54 N	\$396	764
Y	\$761	1160
60 N	\$421	820
Y	\$820	1252
66 N	\$421	877
Y	\$879	1345
72 N	\$455	935
Y	\$936	1437

Everywhere™ Accessories

Modesty Panel *continued*

Everywhere™ Accessories

Step 5. Finish

For thermally-fused laminate top/thermoplastic edge (L)

76	light brown walnut	+\$0
8Q	folkstone grey	+\$0
91	white	+\$0
98	studio white	+\$0
CL	cool grey neutral	+\$0
G1	graphite	+\$0
HM	natural maple	+\$0
HP	light anigre	+\$0
HX	aged cherry	+\$0
LBA	clear on ash	+\$0
LBB	oak on ash	+\$0
LBC	walnut on ash	+\$0
LBF	neutral twill	+\$0
LBJ	graphite twill	+\$0
LBQ	white twill	+\$0
LBR	phantom ecru	+\$0
LBS	phantom cocoa	+\$0
LBU	medium matte walnut	+\$0
LBV	warm grey teak	+\$0
LU	soft white	+\$0
WL	sandstone	+\$0
WN	warm grey neutral	+\$0

For veneer top/veneer edge (W)

2U	light brown walnut	+\$0
40	dark brown walnut	+\$0
UL	natural maple	+\$0

Step 6. Edge Finish

For thermally-fused laminate top/thermoplastic edge (L)

76	light brown walnut	+\$0
8Q	folkstone grey	+\$0
91	white	+\$0
98	studio white	+\$0
BU	black umber	+\$0
CL	cool grey neutral	+\$0
G2	graphite satin	+\$0
HF	inner tone light	+\$0
HM	natural maple	+\$0
HP	light anigre	+\$0
HX	aged cherry	+\$0
LBA	clear on ash	+\$0
LBB	oak on ash	+\$0
LBC	walnut on ash	+\$0
LBF	neutral twill	+\$0
LBJ	graphite twill	+\$0
LBQ	white twill	+\$0
LBR	phantom ecru	+\$0
LBS	phantom cocoa	+\$0
LBU	medium matte walnut	+\$0
LBV	warm grey teak	+\$0
LU	soft white	+\$0
WL	sandstone	+\$0
WN	warm grey neutral	+\$0

Fabric Modesty Panel

Y1114.

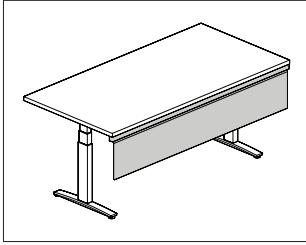

Product Information

Description

This modesty panel attaches to a table, desk, peninsula, or work surface. It has a fabric surface with aluminum top rail and attachment brackets. Attachment hardware included.

Notes

Specify modesty panel to be equal to surface width, or 6" less than surface width of a height adjustable table.

For use with flip top table (DT5Ax.), modesty panel (Y1114.) is recommended to enable optimal folding functionality of the table.

Dimensions



Specification Information

Step 1.

Y1114.

Step 2. Width

- 24** 24" wide
- 30** 30" wide
- 36** 36" wide
- 42** 42" wide
- 48** 48" wide
- 54** 54" wide
- 60** 60" wide
- 66** 66" wide
- 72** 72" wide

Prices for Steps 1-2.

Y1114. 24	\$243
30	\$266
36	\$288
42	\$304
48	\$324
54	\$364
60	\$383
66	\$404
72	\$420

Step 3. Fabric

Price Category 4 +\$28

Everywhere™ Accessories

Cable Trough

Y1200.

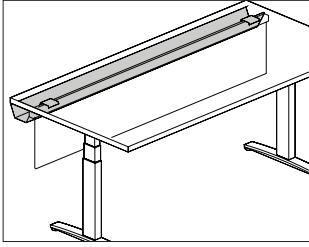

Product Information

Description

This trough attaches to a table, desk, peninsula, or work surface to hold and conceal cords and cables. It pivots down to allow easy access when laying cords inside, and can be specified with an optional modesty panel. The modesty panel has a fabric surface with aluminum top rail. Attachment hardware is included.

Notes

Specify trough to be equal to or less than the surface width.

Dimensions

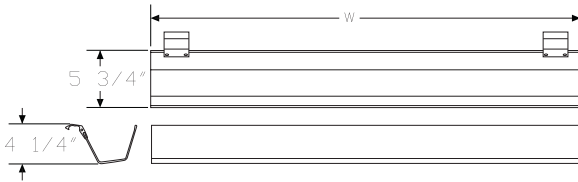

Everywhere™ Accessories

Specification Information

Step 1.

Y1200.

Step 2. Width

24	24" wide
30	30" wide
36	36" wide
42	42" wide
48	48" wide

Step 3. Modesty Panel Option

N	no modesty panel
M	modesty panel

Prices for Steps 1-3.

	N	M
Y1200. 24	\$380	485
30	\$415	545
36	\$455	595
42	\$499	650
48	\$536	706

Step 4. Cable Trough Finish

AN	clear anodized aluminum	+\$0
-----------	-------------------------	------

Step 5. Modesty Panel Fabric

For modesty panel (M)

Price Category 4	+\$28
------------------	-------

Cable Management Trough, Work Surface Suspended AO382.

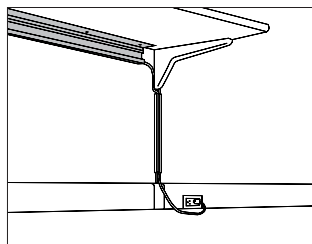

Product Information

Description

This trough attaches under an Action Office® suspended work surface to manage cables. Attachment hardware is included.

Dimensions

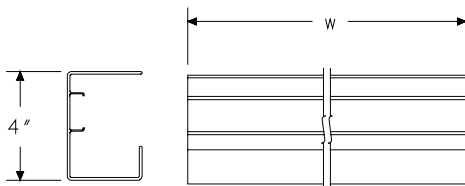

Specification Information

Step 1.

AO382.

Step 2. Width

30 30" wide

40 40" wide

Prices for Steps 1-2.

AO382.30	\$117
40	\$143

Step 3. Surface Finish

BU	black umber	+\$0
MT	medium tone	+\$0

Cord Manager

FV984.

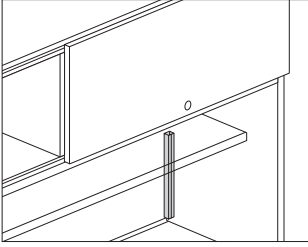

Product Information

Description

This cord manager routes a cord from the underside of a hutch to the surface when a task light is attached. Color is black. Package of 6.

Dimensions

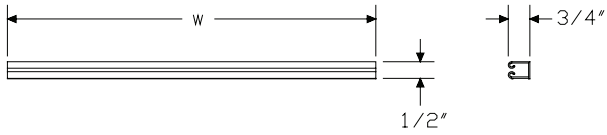

Specification Information

Step 1.

FV984.

Step 2. Height

- 12** 12" high
- 24** 24" high
- 30** 29¹/₂" high

Prices for Steps 1-2.

FV984. 12	\$113
24	\$174
30	\$208

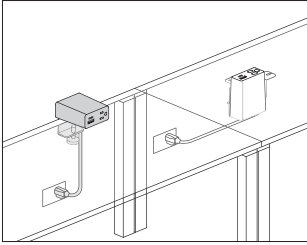

Product Information

Description

This electrical distributor plugs directly into floor, wall, or ceiling drop outlets. Each module configuration presents the same visual appearance. Cable clips and attachment hardware included. Product is UL listed.

Notes

Cable clips for cord management are intended for a 1-time installation.

Clamp versions can be reoriented in the field by a technician.

USB ports provide a combined 20 watts of power to charge most devices and tablets at full speed. USB-C provides 15 watts of power and USB-A provides 10 watts of power individually. When using the USB-C and USB-A ports simultaneously, USB-C remains at 15 watts and USB-A reduces to 5 watts.

Cord color is predetermined. For white (91) finish cords will be white.

For graphite (G1) finish cords will be black.

Grommet mount attachment (Y1414.xxxG) does not come with the mini grommet. Order Logic mini grommet (Y1412.) separately, as needed.

Dimensions

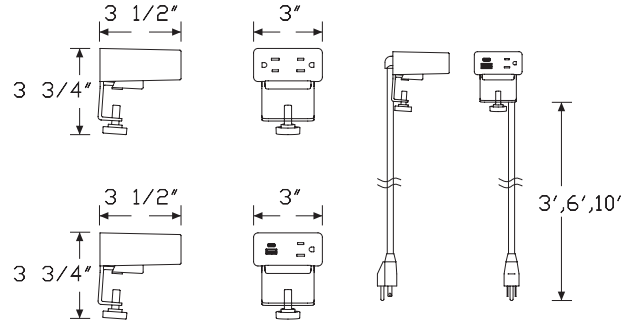

Surface Clamp

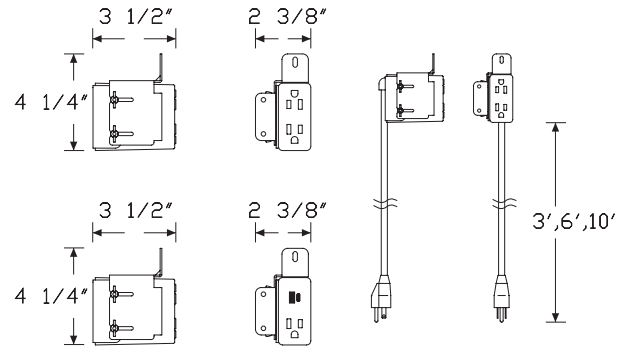

Grommet Mount

Specification Information

Step 1.

Y1414.

Step 2. Configuration

L 1 simplex receptacles, 1 powered USB A/C Combo

K 2 simplex receptacles

Step 3. Cord/Conduit Length

03 3' cord/conduit

06 6' cord/conduit

10 10' cord/conduit

Step 4. Attachment

G grommet mount

S surface clamp

Prices for Steps 1-4.

		G	S
Y1414. L	03	\$457	457
	06	\$457	457
	10	\$468	468
	K 03	\$256	256
	06	\$256	256
	10	\$269	269

Step 5. Finish

BK black **A** +\$0

91 white **A** +\$0

98 studio white **A** +\$0

G1 graphite **A** +\$0

Everywhere™ Accessories

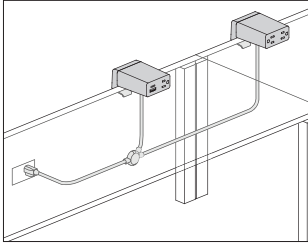

Product Information

Description

This electrical distributor plugs directly into floor, wall, or ceiling drop outlets. Each module configuration presents the same visual appearance. Cable clips and attachment hardware included. Product is ETL listed to UL962.

Notes

Cable clips for cord management are intended for a 1-time installation.

Clamp versions can be reoriented in the field by a technician.

Jumper length denotes distance between center points of each split point.

Cord length denotes distance from plug end to first split point.

Cord color is black for all module finish colors.

All branch lengths from main power cord to module are 12".

USB ports provide a combined 20 watts of power to charge most devices and tablets at full speed. USB-C provides 15 watts of power and USB-A provides 10 watts of power individually. When using the USB-C and USB-A ports simultaneously, USB-C remains at 15 watts and USB-A reduces to 5 watts.

The cord head contains a circuit breaker when there are more than 3 simplex receptacles.

Grommet mount attachment (Y1415.xxxxG) does not come with the mini grommet. Order Logic mini grommet (Y1412.) separately, as needed.

Dimensions

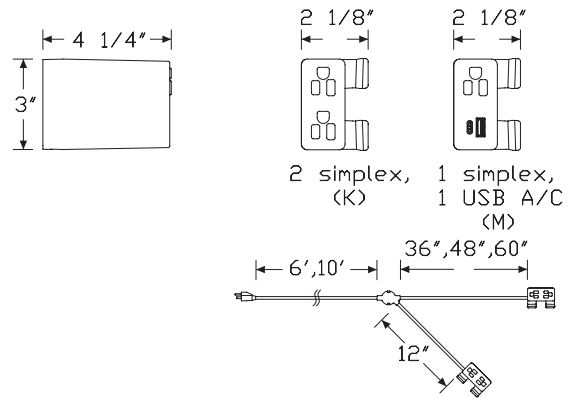

Two Power Modules

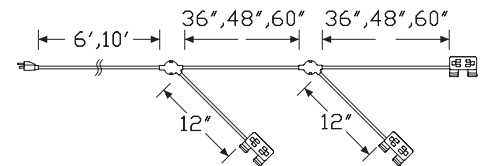

Three Power Modules

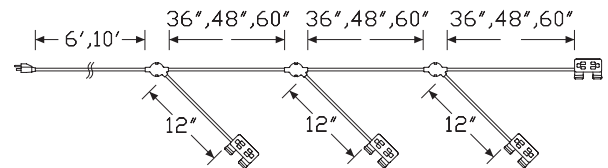

Four Power Modules

Specification Information

Step 1.
Y1415.

Step 2. Number of Modules

- 2** two power modules
- 3** three power modules
- 4** four power modules

Step 3. Power Type

- M** 1 simplex receptacles, 1 powered USB A/C Combo
- K** 2 simplex receptacles, all modules
- N** first module has 1 AC simplex plus 1 powered USB A/C Combo
all other modules have all AC simplexes

Step 4. Jumper Length

- 36** 36" between split points
- 48** 48" between split points
- 60** 60" between split points

Step 5. Attachment

- G** grommet mount
- S** surface clamp

Step 6. Cord/Conduit Length

- 06** 6' cord/conduit
- 10** 10' cord/conduit

Prices for Steps 1-6.

		36G06	36G10	36S06	36S10	48G06	48G10
Y1415. 2	M	\$1005	1019	1005	1019	1017	1032
	K	\$604	617	604	617	614	629
	N	\$804	818	804	818	816	830

3	M	\$1497	1510	1497	1510	1518	1533
	K	\$914	931	914	931	939	950
	N	\$1117	1130	1117	1130	1138	1154

4	M	\$2032	2046	2032	2046	2065	2079
	K	\$1229	1240	1229	1240	1262	1273
	N	\$1428	1442	1428	1442	1462	1474

		48S06	48S10	60G06	60G10	60S06	60S10
Y1415. 2	M	\$1017	1032	1029	1045	1029	1045
	K	\$614	629	624	639	624	639
	N	\$816	830	828	842	828	842

3	M	\$1518	1533	1542	1555	1542	1555
	K	\$939	950	960	972	960	972
	N	\$1138	1154	1163	1175	1163	1175

4	M	\$2065	2079	2113	2127	2113	2127
	K	\$1262	1273	1292	1309	1292	1309
	N	\$1462	1474	1495	1508	1495	1508

Step 7. Finish

- 91** white +\$0
- 98** studio white +\$0
- BK** black +\$0
- G1** graphite +\$0

Logic C1000 Universal Clamp Mount Distributor

Y1423.

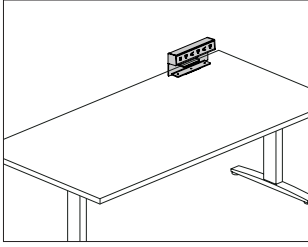

Product Information

Description

This Logic Power Access Solutions™ clamp mounted electrical distributor comes in several widths and configurations of simplex receptacles and USB-A and USB-C charging ports. The unit is powered using a standard power cord with plug end. Data cords can be routed through the integrated opening at the rear of the unit. Product is UL listed.

Notes

Clamp mounts on worksurfaces 1" 1/4" thick.

Faceplate color matches unit color.

Simplex receptacles have alternating orientation and greater than normal plug spacing to accommodate most plug types.

USB ports provide a combined 20 watts of power to charge most devices and tablets at full speed. USB-C provides 15 watts of power and USB-A provides 10 watts of power individually. When using the USB-C and USB-A ports simultaneously, USB-C remains at 15 watts and USB-A reduces to 5 watts.

Dimensions

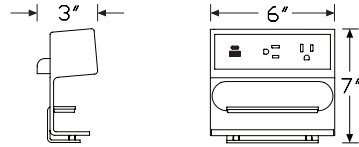

2 simplex receptacles with 1 powered USB A/C combo (H)

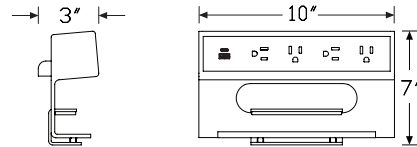

4 simplex receptacles with 1 powered USB A/C combo (I)

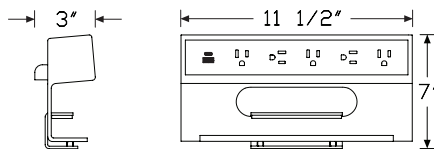

5 simplex receptacles with 1 powered USB A/C combo (J)

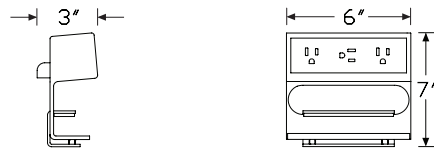

3 simplex receptacles (E)

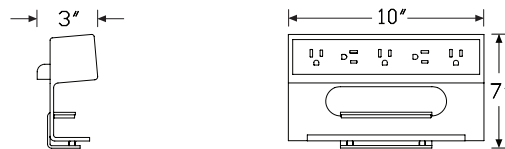

5 simplex receptacles (F)

Logic C1000 Universal Clamp Mount Distributor *continued*

Specification Information

Step 1.

Y1423.

Step 2. Configuration

H	2 simplex receptacles, 1 powered USB A/C Combo
I	4 simplex receptacles, 1 powered USB A/C Combo
J	5 simplex receptacles, 1 powered USB A/C Combo
E	3 simplex receptacles
F	5 simplex receptacles

Step 3. Power Type

A	power cord with plug end
----------	--------------------------

Step 4. Cord/Conduit Length

03	3' cord/conduit
06	6' cord/conduit
10	10' cord/conduit

Prices for Steps 1-4.

		03	06	10
Y1423. H	A	\$614	614	629
	I	\$738	738	750
	J	\$789	789	803
	E	\$412	412	427
	F	\$538	538	550

Step 5. Finish

91	white <input type="checkbox"/>	+\$0
98	studio white <input type="checkbox"/>	+\$0
BK	black <input type="checkbox"/>	+\$0
G1	graphite <input type="checkbox"/>	+\$0
MS	metallic silver <input type="checkbox"/>	+\$0

Everywhere™ Accessories

Logic G1000 Grommet Mounted Electrical Distributor Y1425.

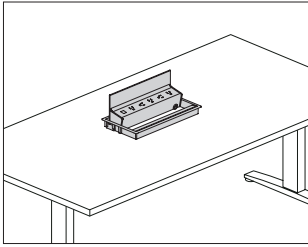

Product Information

Description

This Logic Power Access Solutions™ grommet mounted electrical distributor comes in several widths and configurations of simplex receptacles and USB-A and USB-C charging ports. The unit is powered using a standard power cord with plug end, or an IEC connector when used with Renew™ Sit-to-Stand tables. An integrated cord keeper at the face of the unit captures data cords. The unit pivots from a closed position to 135° allowing easy access to power and data cords stored beneath the unit. Product is UL listed.

Notes

Field cutting of grommet cutout is possible.

IEC connector for Renew power type (C) includes short cord designed to connect to the Renew table power cord through-leg option. Actual cord length may vary.

Simplex receptacles have alternating orientation and greater than normal plug spacing to accommodate most plug types.

USB ports provide a combined 20 watts of power to charge most devices and tablets at full speed. USB-C provides 15 watts of power and USB-A provides 10 watts of power individually. When using the USB-C and USB-A ports simultaneously, USB-C remains at 15 watts and USB-A reduces to 5 watts.

Refer to Renew Sit-to-Stand Tables planning guide for specific application information.

20' cord/conduit length (20) is recommended for Exclave® applications.

Dimensions

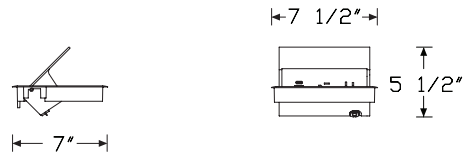

2 simplex receptacles with 1 powered USB A/C combo (H)

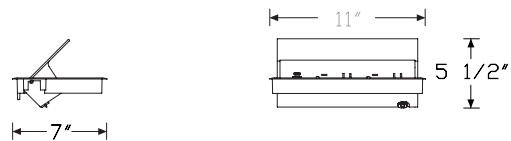

4 simplex receptacles with 1 powered USB A/C combo (I)

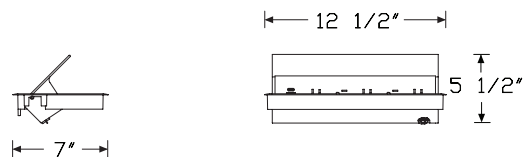

5 simplex receptacles with 1 powered USB A/C combo (J)

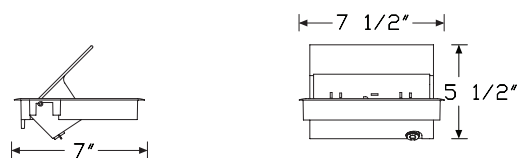

3 simplex receptacles (E)

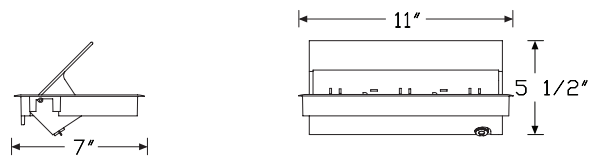

5 simplex receptacles (F)

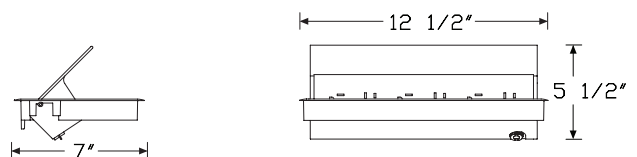

6 simplex receptacles (G)

Logic G1000 Grommet Mounted Electrical Distributor *continued*

Specification Information

Step 1.

Y1425.

Step 2. Configuration

H	2 simplex receptacles, 1 powered USB A/C Combo
I	4 simplex receptacles, 1 powered USB A/C Combo
J	5 simplex receptacles, 1 powered USB A/C Combo
E	3 simplex receptacles
F	5 simplex receptacles
G	6 simplex receptacles

Step 3. Power Type

A	power cord with plug end
C	IEC connector for Renew Tables

Step 4. Cord/Conduit Length

For power cord with plug end (A)

03	3' cord/conduit
06	6' cord/conduit
10	10' cord/conduit
20	20' cord/conduit

For IEC connector for Renew Tables (C)

03	3' cord/conduit
-----------	-----------------

Prices for Steps 1-4.

		03	06	10	20
Y1425. H	A	\$873	873	887	901
	C	\$887	—	—	—
	I A	\$1011	1011	1028	1042
	C	\$1028	—	—	—
	J A	\$1104	1104	1117	1130
	C	\$1117	—	—	—
	E A	\$672	672	685	697
	C	\$685	—	—	—
	F A	\$811	811	826	841
	C	\$826	—	—	—
	G A	\$901	901	914	931
	C	\$914	—	—	—

Step 5. Finish

91	white <input type="checkbox"/> A	+\$0
98	studio white <input type="checkbox"/> A	+\$0
BK	black <input type="checkbox"/> A	+\$0
G1	graphite <input type="checkbox"/> A	+\$0
MS	metallic silver <input type="checkbox"/> A	+\$0

Everywhere™ Accessories

Logic Mini Grommet

Y1412.

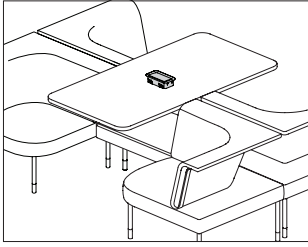

Product Information

Description

This Logic Power Access Solutions™ plastic grommet is available in mini rectangle or mini square configuration. The integrated flaps can hide the things below the surface while also retaining power and data cords.

Notes

This grommet is installed in some HermanMiller applications. Verify your application before ordering grommet separately.

Dimensions

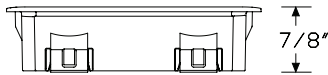
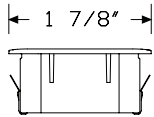
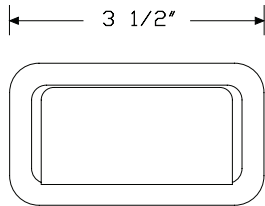

Grommet - Rectangle

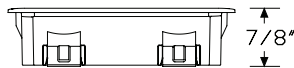
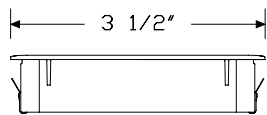
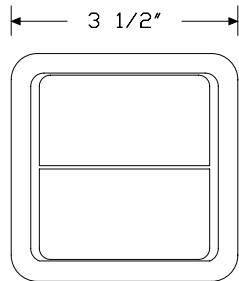

Grommet - Square

Specification Information

Step 1.

Y1412.

Step 2. Configuration

- 1 mini rectangle grommet
- 2 mini square grommet

Prices for Steps 1-2.

Y1412. 1	\$40
2	\$45

Step 3. Finish

91	white	+\$0
98	studio white	+\$0
BK	black	+\$0
G1	graphite	+\$0

Connect™-Ganging Bracket Kit Y1338.

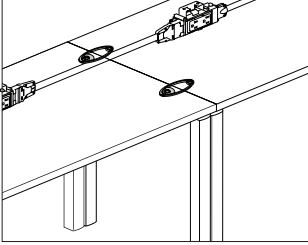

Product Information

Description
This kit has 2 clips that attach to the underside of 2 adjacent surfaces, ganging them together to provide stability and allowing electrical components to be routed from 1 surface to another. Finish is black.

Notes

Ganging bracket kit should not be used on 18"-deep Everywhere™ tables.

Dimensions

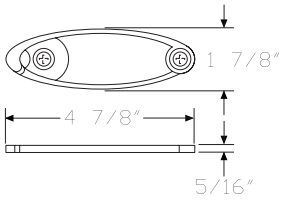

Specification Information

Step 1.
Y1338. \$115

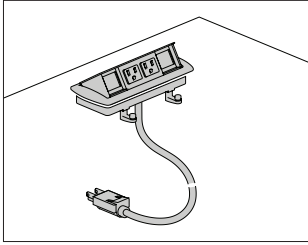

Product Information

Description

This electrical distributor mounts flush in a surface and has a one-touch pop-up mechanism for accessing power and data. It has 2 simplex receptacles and 2 data openings, and is available with a power cord with plug end, or electrical conduit for hardwire connection. A voice/data adapter kit is included, allowing the data openings to accept various manufacturers' couplers and jacks. Attachment hardware and cord/cable clips are also included. Product is UL listed.

Notes

Field cutting of surface may be required. Information on surface cutout size is included on instruction sheet.

Dimensions

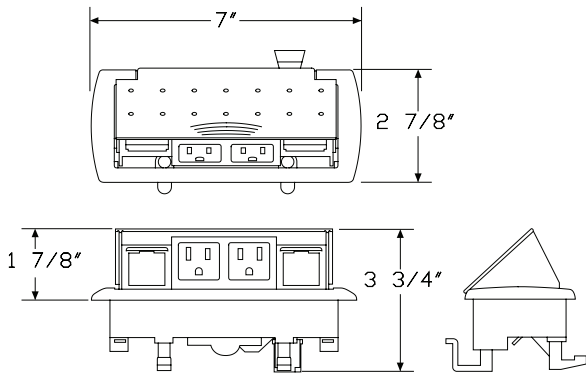

Specification Information

Step 1.

Y1321.

Step 2. Power Type

- A** power cord with plug end
- B** conduit with open end, for hard-wiring

Step 3. Cord/Conduit Length

- 03** 3' cord/conduit
- 06** 6' cord/conduit
- 10** 10' cord/conduit
- 20** 20' cord/conduit

Prices for Steps 1-3.

	03	06	10	20
Y1321. A	\$299	299	312	383
B	\$374	374	389	459

Step 4. Wiring Type

- 4Z** standard +\$0

Step 5. Finish

- 0H** black +\$0

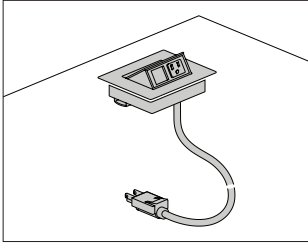

Product Information

Description

This electrical distributor mounts flush in a surface and has a one-touch pop-up mechanism for accessing power and data. It can be configured with 2 simplex receptacles, or 1 simplex receptacle and 1 data opening. The distributor is available with a power cord with plug end, or electrical conduit for hardwire connection. A voice/data adapter kit is included, allowing the data openings to accept various manufacturers' couplers and jacks. Attachment hardware and cord/cable clips are also included. Product is UL listed.

Notes

Field cutting of surface may be required. Information on surface cutout size is included on instruction sheet.

Distributor with PVC-free wiring option (LZ) is Cradle to Cradle Silver Certified.

Distributor with silver finish option (OI) or white finish option (OJ) and standard wiring (4Z) has painted metal trim with white plastic simplex/data interior. Distributor with black finish option (OH) and standard wiring (4Z) has black painted trim with black plastic simplex/data interior. Distributor with PVC-free wiring option (LZ) has black plastic simplex/data interior, regardless of the finish color.

Dimensions

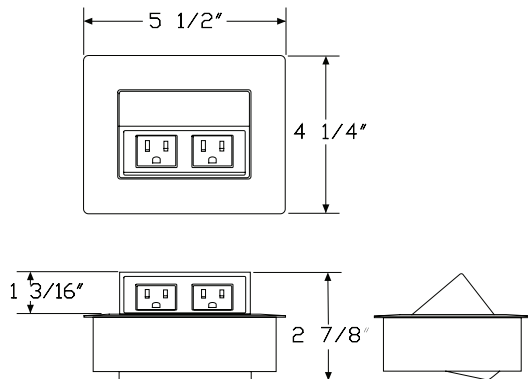

Everywhere™ Accessories

Specification Information

Step 1.

Y1322.

Step 2. Configuration

- 1** 1 simplex receptacle, 1 data opening
- 2** 2 simplex receptacles

Step 3. Power Type

- A** power cord with plug end
- B** conduit with open end, for hard-wiring

Step 4. Cord/Conduit Length

- 03** 3' cord/conduit
- 06** 6' cord/conduit
- 10** 10' cord/conduit
- 20** 20' cord/conduit

Prices for Steps 1-4.

		03	06	10	20
Y1322. 1	A	\$355	355	367	437
	B	\$429	429	441	509
2	A	\$374	374	389	459
	B	\$450	450	465	535

Step 5. Wiring Type

- 4Z** standard +\$0
- LZ** PVC-free +\$39

Step 6. Finish

- OH** black +\$0
- OI** silver +\$0
- OJ** white +\$0

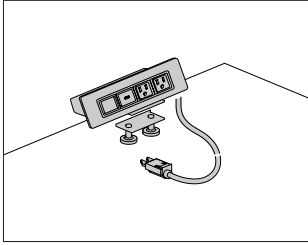

Product Information

Description

This electrical distributor can grommet-mount flush in a surface, or clamp-mount to the edge. It can be configured with several combinations of simplex receptacles, data openings, and USB charging ports. The distributor is available with a power cord with plug end, or electrical conduit for hardwire connection. A voice/data adapter kit is included, allowing the data openings to accept various manufacturers' couplers and jacks. Attachment hardware and cord/cable clips are also included. Product is UL listed.

Notes

Field cutting of surface may be required. Information on surface cutout size is included on instruction sheet.
 Silver option (0I) and white option (0J) have painted metal trim with white plastic simplex/data interiors. Black option (0H) has black painted trim with black plastic simplex/data interior.
 Overall width for distributor with 4 openings is 8" wide. Overall width for distributor with 6 openings is 11" wide.
 USB port charges at 2.1 amps.

Dimensions

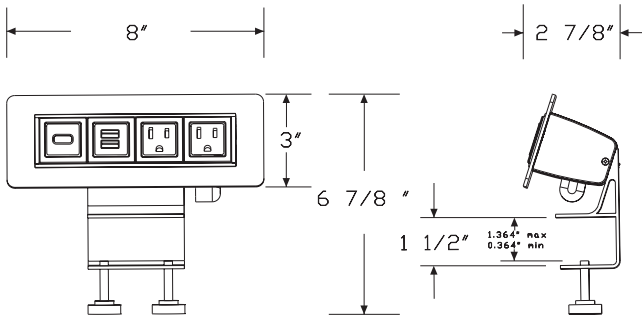

Specification Information

Step 1.

Y1323.

Step 2. Configuration

- 3** 2 simplex receptacles, 2 data openings
- 4** 3 simplex receptacles, 3 data openings
- 5** 2 simplex receptacles, 1 data opening, 1 charging USB port
- 6** 3 simplex receptacles, 2 data opening, 1 charging USB port

Step 3. Power Type

- A** power cord with plug end
- B** conduit with open end, for hard-wiring

Step 4. Cord/Conduit Length

- 03** 3' cord/conduit
- 06** 6' cord/conduit
- 10** 10' cord/conduit
- 20** 20' cord/conduit

Step 5. Attachment

- G** grommet mount
- S** surface clamp

Prices for Steps 1-5.

		03G	03S	06G	06S	10G	10S
Y1323. 3	A	\$402	402	402	402	420	420
	B	\$478	478	478	478	495	495
4	A	\$501	501	501	501	514	514
	B	\$581	581	581	581	595	595
5	A	\$563	563	563	563	579	579
	B	\$642	642	642	642	654	654
6	A	\$661	661	661	661	678	678
	B	\$741	741	741	741	755	755
						20G	20S
Y1323. 3	A					\$489	489
	B					\$561	561
4	A					\$588	588
	B					\$661	661
5	A					\$648	648
	B					\$750	750
6	A					\$745	745
	B					\$853	853

Everywhere™ Accessories

Step 6. Finish		
0H	black	+\$0
0I	silver	+\$0
0J	white	+\$0

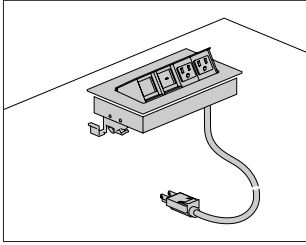

Product Information

Description

This electrical distributor mounts flush in a surface and has a one-touch pop-up mechanism for accessing power and data. It can be configured with several combinations of simplex receptacles, data openings, and USB charging ports. The distributor is available with a power cord with plug end, or electrical conduit for hardwire connection. A voice/data adapter kit is included, allowing the data openings to accept various manufacturers' couplers and jacks. Attachment hardware and cord/cable clips are also included. Product is UL listed.

Notes

Field cutting of surface may be required. Information on surface cutout size is included on instruction sheet.
 Distributor with PVC-free wiring option (LZ) is Cradle to Cradle Silver Certified.
 Distributor with silver anodized finish option (OK) and standard wiring (4Z) has anodized trim with white plastic simplex/data interior.
 Distributor with silver anodized finish option (OK) and PVC-free wiring (LZ) has anodized trim with black plastic simplex/data interior.
 Overall width for distributor with openings is 8 1/4" wide. Overall width for distributor with 7 openings is 12 3/4" wide.
 USB port charges at 2.1 amps.

Dimensions

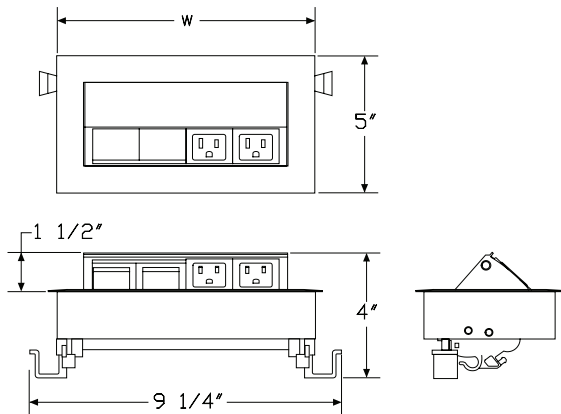

Specification Information

Step 1.

Y1324.

Step 2. Configuration

3	2 simplex receptacles, 2 data openings
5	3 simplex receptacles, 4 data openings
6	2 simplex receptacles, 1 data opening, 1 charging USB port
7	3 simplex receptacles, 3 data opening, 1 charging USB port
8	3 simplex receptacles, 2 data opening, 2 charging USB ports

Step 3. Power Type

A	power cord with plug end
B	conduit with open end, for hard-wiring

Step 4. Cord/Conduit Length

03	3' cord/conduit
06	6' cord/conduit
10	10' cord/conduit
20	20' cord/conduit

Prices for Steps 1-4.

		03	06	10	20
Y1324. 3	A	\$561	561	576	646
	B	\$637	637	654	721
5	A	\$720	720	735	803
	B	\$797	797	806	874
6	A	\$721	721	735	803
	B	\$800	800	814	884
7	A	\$880	880	898	967
	B	\$959	959	970	1037
8	A	\$1041	1041	1055	1126
	B	\$1120	1120	1130	1196

Step 5. Wiring Type

4Z	standard		+\$0
LZ	PVC-free		+\$39

Step 6. Finish

OK	silver anodized		+\$0
-----------	-----------------	--	------

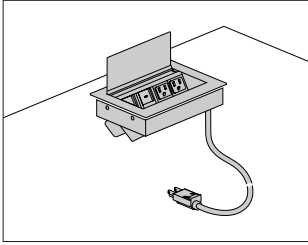

Product Information

Description

This electrical distributor mounts flush in a surface and has a flip-up lid for accessing power and data from above or below the surface. The flip lid can be closed once devices are connected for a clean visual appearance. It can be configured with several combinations of simplex receptacles, data openings, and USB charging ports. The distributor is available with a power cord with plug end, or electrical conduit for hardwire connection. A voice/data adapter kit is included, allowing the data openings to accept various manufacturers' couplers and jacks. Attachment hardware and cord/cable clips are also included. Product is UL listed.

Notes

Field cutting of surface may be required. Information on surface cutout size is included on instruction sheet.

Silver anodized option (OK) has anodized trim with white plastic simplex/data interior.

Overall width for distributor with 4 openings is 8³/₈" wide. Overall width for distributor with 6 openings is 11³/₈" wide.

USB port charges at 2.1 amps.

Dimensions

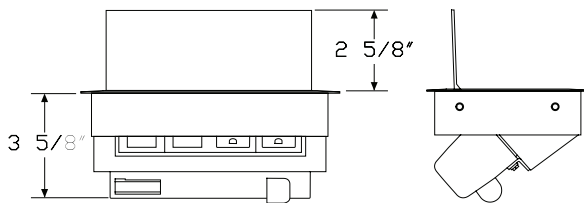
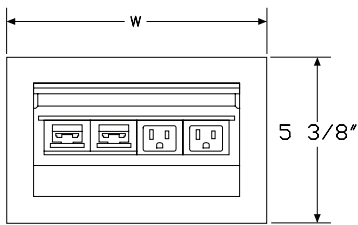

Specification Information

Step 1.

Y1325.

Step 2. Configuration

- 3** 2 simplex receptacles, 2 data openings
- 7** 3 simplex receptacles, 3 data openings
- 5** 2 simplex receptacles, 1 data opening, 1 charging USB port
- 6** 3 simplex receptacles, 2 data opening, 1 charging USB port

Step 3. Power Type

- A** power cord with plug end
- B** conduit with open end, for hard-wiring

Step 4. Cord/Conduit Length

- 03** 3' cord/conduit
- 06** 6' cord/conduit
- 10** 10' cord/conduit
- 20** 20' cord/conduit

Prices for Steps 1-4.

		03	06	10	20
Y1325.3	A	\$660	660	677	744
	B	\$739	739	750	819
7	A	\$759	759	777	844
	B	\$838	838	852	922
5	A	\$824	824	838	906
	B	\$901	901	913	980
6	A	\$922	922	936	1007
	B	\$998	998	1014	1081

Step 5. Finish

- OK** silver anodized +\$0

Connect™ - S720 - Connect Single Circuit Power Unit

Y1372.

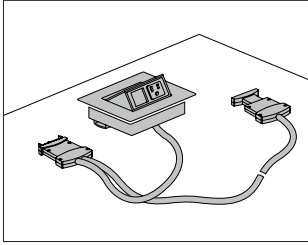

Product Information

Description

This dedicated modular single circuit electrical distributor mounts flush in a surface and has a one-touch pop-up mechanism for accessing power and data. It can be configured with 2 simplex receptacles, or 1 simplex receptacle and 1 data opening. Cord length is 60". A maximum of 8 single circuit electrical distributors can be daisy chained per power entry. A voice/data adapter kit is included, allowing the data openings to accept various manufacturers couplers and jacks. Attachment hardware and cord/cable clips are also included.

Notes

Field cutting of surface may be required. For information on surface cutout size, see included instruction sheet.

UL listed when used in conjunction with most Everywhere™ fixed height tables.

To gang tables together per electrical code requirements, order ganging bracket kit (Y1338.) separately.

Order single circuit power entry (Y1377.) separately.

Where lengths of greater than 60" are needed, order single circuit jumpers (Y1378.) separately. Each single circuit jumper counts toward the 8 allowed electrical distributors per power entry.

Silver option (OI) and white option (OJ) have painted metal trim with white plastic simplex/data interiors. Black option (OH) has black painted trim with black plastic simplex/data interior.

Dimensions

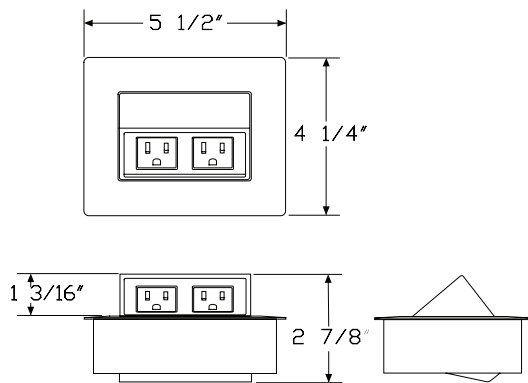

Specification Information

Step 1.

Y1372.

Step 2. Configuration

- | | |
|----------|--------------------------------------|
| 1 | 1 simplex receptacle, 1 data opening |
| 2 | 2 simplex receptacles |

Step 3. Cord Length

60 60" long

Prices for Steps 1-3.

	60
Y1372. 1	\$514
2	\$536

Step 4. Finish

OH	black	+\$0
OI	silver	+\$0
OJ	white	+\$0

Everywhere™ Accessories

Connect™ - S730 - Connect Single Circuit Power Unit

Y1373.

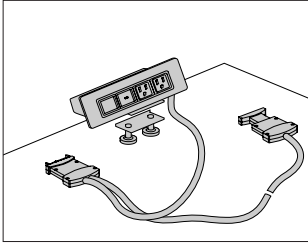

Product Information

Description

This dedicated modular single circuit electrical distributor mounts flush in a surface or with an edge clamp mount. It has 2 simplex receptacles and 2 data openings, or 2 simplex receptacles and 1 data opening and 1 USB charging port, and a 60" cord. A maximum of 8 single circuit electrical distributors can be daisy chained per power entry. A voice/data adapter kit is included, allowing the data openings to accept various manufacturers' couplers and jacks. Attachment hardware and cord/cable clips are also included.

Notes

Field cutting of surface may be required. For information on surface cutout size, see included instruction sheet.

UL listed when used in conjunction with most Everywhere™ fixed height tables.

To gang tables together per electrical code requirements, order ganging bracket kit (Y1338.) separately.

Order single circuit power entry (Y1377.) separately.

Where lengths of greater than 60" are needed, order single circuit jumpers (Y1378.) separately. Each single circuit jumper counts toward the 8 allowed electrical distributors per power entry.

Silver option (OI) and white option (OJ) have painted metal trim with white plastic simplex/data interiors. Black option (OH) has black painted trim with black plastic simplex/data interior.

USB port charges at 2.1 amps.

Dimensions

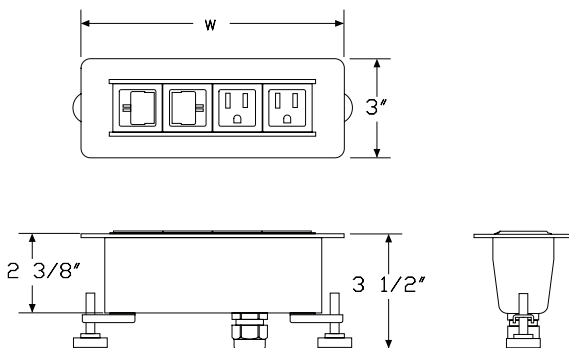

Specification Information

Step 1.

Y1373.

Step 2. Configuration

- 3** 2 simplex receptacles, 2 data openings
- 4** 2 simplex receptacles, 1 data opening, 1 charging USB port

Step 3. Cord Length

- 60** 60" long

Step 4. Attachment

- G** grommet mount
- S** surface clamp

Prices for Steps 1-4.

		G	S
Y1373. 3	60	\$581	563
	4 60	\$741	727

Step 5. Finish

OH	black	+\$0
OI	silver	+\$0
OJ	white	+\$0

Connect™ - S740 - Connect Single Circuit Power Unit

Y1374.

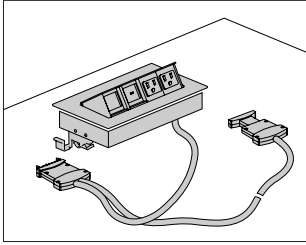

Product Information

Description

This dedicated modular single circuit electrical distributor mounts flush in a surface and has a one-touch pop-up mechanism for accessing power and data. It has 2 simplex receptacles and 2 data openings, or 2 simplex receptacles and 1 data opening and 1 USB charging port, and a 60" cord. A maximum of 8 single circuit electrical distributors can be daisy chained per power entry. A voice/data adapter kit is included, allowing the data openings to accept various manufacturers' couplers and jacks. Attachment hardware and cord/cable clips are also included.

Notes

Field cutting of surface may be required. For information on surface cutout size, see included instruction sheet.

UL listed when used in conjunction with most Everywhere™ fixed height tables.

To gang tables together per electrical code requirements, order ganging bracket kit (Y1338.) separately.

Order single circuit power entry (Y1377.) separately.

Where lengths of greater than 60" are needed, order single circuit jumpers (Y1378.) separately. Each single circuit jumper counts toward the 8 allowed electrical distributors per power entry.

Silver anodized option (OK) has anodized trim with white plastic simplex/data interior.

Overall width for distributor with 4 openings is 8 1/4" wide.

USB port charges at 2.1 amps.

Dimensions

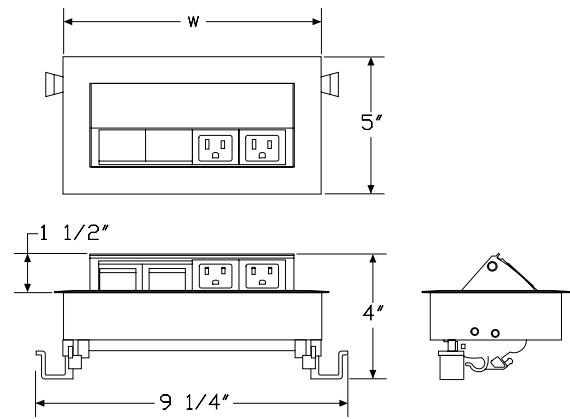

Connect™ - S740 - Connect
 Single Circuit Power Unit *continued*

Specification Information

Step 1.

Y1374.

Step 2. Configuration

- 3** 2 simplex receptacles, 2 data openings
- 4** 2 simplex receptacles, 1 data opening, 1 charging USB port

Step 3. Cord Length

60 60" long

Prices for Steps 1-3.

	60
Y1374. 3	\$719
4	\$878

Step 4. Finish

OK silver anodized + \$0

Everywhere™ Accessories

Connect™ - S750 - Connect Single Circuit Power Unit

Y1375.

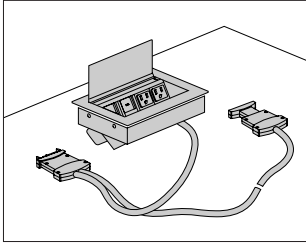

Product Information

Description

This dedicated modular single circuit electrical distributor mounts flush in a surface and has a flip-up lid for accessing power and data from above or below the surface. The lid can be closed once devices are connected for a clean visual appearance. The distributor has 2 simplex receptacles and 2 data openings, or 2 simplex receptacles and 1 data opening and 1 USB charging port, and a 60" cord. A maximum of 8 single circuit electrical distributors can be daisy chained per power entry. A voice/data adapter kit is included, allowing the data openings to accept various manufacturers' couplers and jacks. Attachment hardware and cord/cable clips are also included.

Notes

Field cutting of surface may be required. For information on surface cutout size, see included instruction sheet.

UL listed when used in conjunction with most Everywhere™ fixed height tables.

To gang tables together per electrical code requirements, order ganging bracket kit (Y1338.) separately.

Order single circuit power entry (Y1377.) separately.

Where lengths of greater than 60" are needed, order single circuit jumpers (Y1378.) separately. Each single circuit jumper counts toward the 8 allowed electrical distributors per power entry.

Silver anodized option (OK) has anodized trim with white plastic simplex/data interior.

Overall width for distributor with 4 openings is 8³/₈" wide.

USB port charges at 2.1 amps.

Dimensions

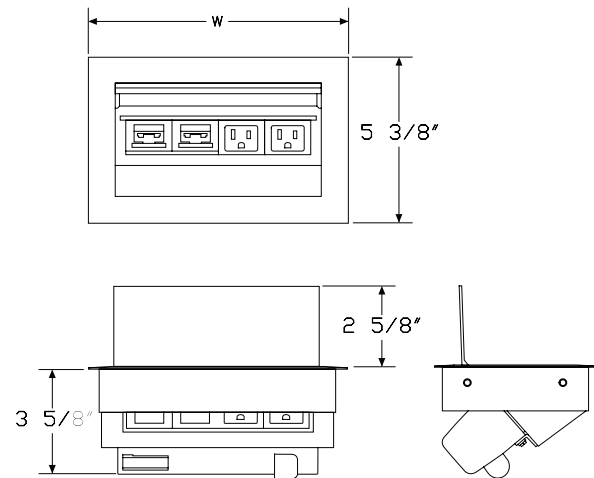

Connect™ - S750 - Connect
 Single Circuit Power Unit *continued*

Specification Information

Step 1.

Y1375.

Step 2. Configuration

- 3** 2 simplex receptacles, 2 data openings
- 4** 2 simplex receptacles, 1 data opening, 1 charging USB port

Step 3. Cord Length

60 60" long

Prices for Steps 1-3.

	60
Y1375. 3	\$815
4	\$977

Step 4. Finish

OK silver anodized + \$0

Everywhere™ Accessories

Connect™ Single Circuit Electrical Y1377. Power Entry

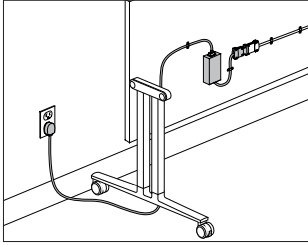

Product Information

Description

This standard receptacle 15-amp power entry provides power for single circuit electrical distributors. Up to 8 single circuit modular electrical distributors can be daisy chained and connected in any order. If more than 8 units are connected to this power entry, the system automatically shuts down and a red LED illuminates. A green LED indicates that more units can be connected and the system is ready. Standard attachment hardware is included.

Notes

UL listed when used in conjunction with most Everywhere™ fixed height tables.

Order electrical distributors (Y1372., Y1373., Y1374., Y1375.) and single circuit jumpers (Y1378.) separately.

Dimensions

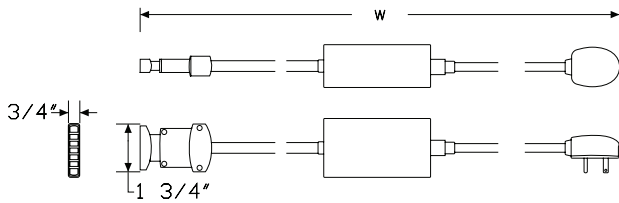

Specification Information

Step 1.

Y1377.

Step 2. Cord Length

06 6' long
10 10' long

Prices for Steps 1-2.

Y1377. 06	\$658
10	\$691

Connect™ Single Circuit Electrical By-Pass Jumper Y1378.

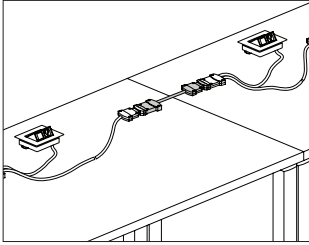

Product Information

Description
 This electrical jumper provides additional length for the Connect™ single circuit modular electrical system. Jumpers are available in a variety of lengths and count as one of the 8 electrical distributors allowed per power entry.

Notes

UL listed when used in conjunction with most Everywhere™ fixed height tables.
 Order electrical distributors (Y1372., Y1373., Y1374., Y1375.) and single circuit power entry (Y1377.) separately.

Dimensions

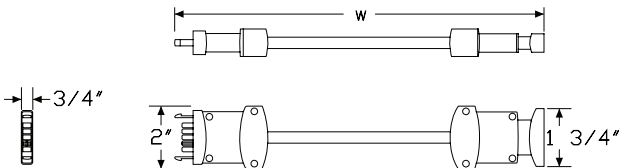

Specification Information

Step 1.

Y1378.

Step 2. Cord Length

12	12" long
24	24" long
36	36" long
48	48" long
60	60" long

Prices for Steps 1-2.

Y1378. 12	\$139
24	\$150
36	\$165
48	\$178
60	\$188

Index by Product Name

Everywhere™ Tables	
Cable Management Clip	page(s) 127
Cable Management Trough, Work Surface Suspended	133
Cable Trough	132
Classroom Curve Table	47
Concave Rectangle	37
Conference Corner Table	51
Conference Table HD Trough	119
Connect™-Ganging Bracket Kit	144
Connect™-S100	121, 145
Connect™-S200	122, 146
Connect™-S300	123, 147
Connect™-S400	125, 149
Connect™-S500	126, 150
Connect™ - S720 - Connect Single Circuit Power Unit	151
Connect™ - S730 - Connect Single Circuit Power Unit	152
Connect™ - S740 - Connect Single Circuit Power Unit	153
Connect™ - S750 - Connect Single Circuit Power Unit	155
Connect™ Single Circuit Electrical By-Pass Jumper	158
Connect™ Single Circuit Electrical Power Entry	157
Cord Manager	134
D-Shaped Table	26
Fabric Modesty Panel	131
Flat Edge Screen, Delineation	96
Flat Edge Screen, Surface Attached	92
Flat Edge Screen, Surface Attached with Modesty	94
Flip-Top Rectangular Table	57
Half Round Table	67
Laminate Screen, Surface Attached	98
Laminate Screen, Surface Attached with Modesty	100
Logic C1000 Universal Clamp Mount Distributor	113, 139
Logic G1000 Grommet Mounted Electrical Distributor	115, 141
Logic G1200 Grommet Pass Thru	118
Logic HD Cable Manager	120
Logic Mini	109, 135
Logic Mini Grommet	117, 143
Logic Mini - Vine	111, 137
Metal Straight Screen, Surface Attached with Modesty	102
Modesty Panel	103, 129
Occasional Table, Round	87
Occasional Table, Square	84
Oval Table	22
Pari Screen, Delineation	90
Pari Screen, Surface Attached	107
Pari Screen, Surface Attached with Modesty	105
Rectangular Table	5
Round Corner Table	54

Round Table	18
Soft Rectangle - Extended Meeting Table	64
Soft Rectangle - Meeting Table	30
Soft Square Table	41
Square Table	14
Standard-Height Table Base	77
Standard-Height Table Leg	74
Standing-Height Round Table	81
Standing-Height Square Table	78
Tear Drop Table	44
Trapezoid Table	70
Vertical Cord Covers	128
Video Oval - Meeting Table	34
Wedge Table	61

Index by Product Number

AO382. Cable Management Trough, Work Surface			
Suspended		page(s)	133
DT1AE. Rectangular Table			5
DT1AS.			
DT1AT.			
DT1BE. Square Table			14
DT1BS.			
DT1BT.			
DT1CE. Round Table			18
DT1CS.			
DT1CT.			
DT1DE. Oval Table			22
DT1DS.			
DT1DT.			
DT1EE. D-Shaped Table			26
DT1ES.			
DT1ET.			
DT1FE. Soft Rectangle - Meeting Table			30
DT1FS.			
DT1FT.			
DT1GE. Video Oval - Meeting Table			34
DT1GS.			
DT1GT.			
DT1HE. Concave Rectangle			37
DT1HS.			
DT1HT.			
DT1JE. Soft Square Table			41
DT1JS.			
DT1JT.			
DT1KE. Tear Drop Table			44
DT1KS.			
DT1KT.			
DT1LE. Classroom Curve Table			47
DT1LS.			
DT1LT.			
DT1ME. Conference Corner Table			51
DT1MS.			
DT1MT.			
DT1NE. Round Corner Table			54
DT1NS.			
DT1NT.			
DT1PS. Soft Rectangle - Extended Meeting Table			64
DT1PT.			
DT1RS. Half Round Table			67
DT1TS. Trapezoid Table			70
DT1WS. Wedge Table			61
DT2A. Standard-Height Table Leg			74
DT2B. Standard-Height Table Base			77
DT3BE. Standing-Height Square Table			78
DT3BS.			
DT3BT.			
DT3CE. Standing-Height Round Table			81
DT3CS.			
DT3CT.			
DT4BS. Occasional Table, Square			84
DT4BT.			
DT4CS. Occasional Table, Round			87
DT4CT.			
DT5AE. Flip-Top Rectangular Table			57
DT5AS.			
DT5AT.			
DT9A. Cable Management Clip			127
DT9B. Vertical Cord Covers			128
DT9C. Conference Table HD Trough			119
FT351. Pari Screen, Surface Attached			107
FT353. Pari Screen, Surface Attached with Modesty			105
FT354. Pari Screen, Delineation			90
FT356. Flat Edge Screen, Surface Attached			92
FT357. Flat Edge Screen, Surface Attached with Modesty			94
FT358. Flat Edge Screen, Delineation			96
FT360. Laminare Screen, Surface Attached			98
FT361. Laminare Screen, Surface Attached with Modesty			100
FV984. Cord Manager			134
Y1113. Modesty Panel			103, 129
Y1114. Fabric Modesty Panel			131
Y1200. Cable Trough			132
Y1321. Connect™-S100			121, 145
Y1322. Connect™-S200			122, 146
Y1323. Connect™-S300			123, 147
Y1324. Connect™-S400			125, 149
Y1325. Connect™-S500			126, 150
Y1338. Connect™-Ganging Bracket Kit			144
Y1372. Connect™ - S720 - Connect Single Circuit Power Unit			151
Y1373. Connect™ - S730 - Connect Single Circuit Power Unit			152
Y1374. Connect™ - S740 - Connect Single Circuit Power Unit			153
Y1375. Connect™ - S750 - Connect Single Circuit Power Unit			155
Y1377. Connect™ Single Circuit Electrical Power Entry			157
Y1378. Connect™ Single Circuit Electrical By-Pass Jumper			158
Y1412. Logic Mini Grommet			117, 143
Y1414. Logic Mini			109, 135
Y1415. Logic Mini - Vine			111, 137
Y1420. Logic G1200 Grommet Pass Thru			118
Y1423. Logic C1000 Universal Clamp Mount Distributor			113, 139
Y1424. Logic HD Cable Manager			120

Index by Product Number *continued*



Index: Product Number

Y1425. Logic G1000 Grommet Mounted Electrical	
Distributor	115, 141
YT250. Metal Straight Screen, Surface Attached with Modesty	102

20-Day or Less/Assigned Lead-Time Order Information

20-Day or Less and Assigned Lead-Time Programs

20-day or less and assigned lead-time products are designed for established Herman Miller dealers with pre-approved credit.

Products are distributed from multiple manufacturing facilities across the United States. All products and options not designated by an Assigned Lead-Time icon  will ship in 20 business days or less after being acknowledged by Herman Miller. Products and options designated by an  are on the assigned lead-time program and will ship in 20 days, less than 20 days, or more than 20 days from order acknowledgement.

Ordering Procedure

Please place orders through Order Manager. If this is not available to you, place orders through mail or fax. Verbal purchase orders will not be accepted.

Order Entry fax number for Meridian®

Filing and Storage: (616) 846 9236.

Order Entry fax number for all other products:

(616) 654 3085.

For more information, contact your Customer Care representative at:
(866) 854 3048 ext 3400.

Shipments and Delivery

Per Herman Miller Terms and Conditions.

Changes and Cancellation

Per Herman Miller Terms and Conditions.



Vary Easy Program

Program Overview

The Vary Easy program offers expanded product selections beyond what is available through our standard offering. From expanded material and finish lists, to size availability, to completely new product configurations, the Vary Easy program offers it all at standard pricing, warranty, and lead-time.

Specifying Vary Easy using Made-to-Measure Plus

Vary Easy products are now available by clicking the Vary Easy/Options tile in the Made-to-Measure Plus tool.

Made-to-Measure Plus is a web-based tool available through Omni that takes the guesswork out of specifying products and service parts. It's quickly evolving to become your one-stop shop for specifying Herman Miller products and service parts, particularly customized product like Vary Easy and HM Options.

Vary Easy products are no longer published in marketing SIF for importing into specIT and other third-party specifiers. Specifying through the Made-to-Measure Plus tool allows us to make frequent updates and offer more complex products. It allows you to easily specify and price products and download SIF files to import into your specification tool. The acknowledgement process for Vary Easy products is the same as for any standard order. Vary Easy products ship with a standardized lead-time and are competitively priced.

For step-by-step instructions, reference the Made-to-Measure Plus page under Tools & Resources on Omni to watch the how-to video and to see how easy it is to specify Vary Easy products in Made-to-Measure Plus.

For Vary Easy product and specification questions, contact Product Services at 866 854 3048 (ext #1).

For technical questions about the Made-to-Measure Plus tool, contact Sales Technology Support at 866 854 3048 (ext #4) or sts@hermanmiller.com.

Stain-to-Match Program

Stain-to-Match Program

Program Overview

The Stain-to-Match program gives you the option of using veneer finishes that are not listed in the standard offering. The program allows Herman Miller to match a customer's existing recut or natural veneer, or create a new finish that is unique to an installation.

Specific information on approval, ordering, pricing, and warranty for the Stain-to-Match program is listed below. Questions and requests for assistance may be directed to Herman Miller Options at:

(800) 654 3910

Stain-to-Match Process

1. Fill out the Options Stain-to-Match Request Form and send along with a color sample (2" x 3" minimum) to the Herman Miller Options Applications Team at the address provided on the form. The form can be found on Omni.
2. Within 7-10 working days, Herman Miller Options will send a sample of the color-matched stain on Herman Miller veneer to the requester for the customer's signed approval.
3. If the sample meets the customer's approval, sign the reverse side of the sample, scan and email the approval to: options@hermanmiller.com.
4. After the stain has been approved, a formal quotation with special number and pricing can be provided, or the product can be specified through the Vary Easy program, if available. Work with the Options team on final product needs and how to specify.
5. A purchase order can then be placed.

Stain-to-Match Warranty

Herman Miller warrants its products to be free from defects in craftsmanship from the date of delivery for the applicable warranty period. Herman Miller is responsible for the physical properties of the veneers available through the Stain-to-Match program, which include:

- STA: Stain-to-Match on Recut Ash
- STC: Stain-to-Match on Cherry
- STD: Stain-to-Match on Oak
- STK: Stain-to-Match on Reltech Anigre (Geiger)
- STP: Stain-to-Match on Maple
- STU: Stain-to-Match on Walnut (Geiger)

See your specification tool for product specific finish offering limitations.

For more information about our products and services or to see a list of dealers, please visit us at HermanMiller.com or call (800) 851 1196.

© 2024 Herman Miller, Inc., Zeeland, Michigan

Distribution Rights

Working together since 1956, Herman Miller and Vitra are the authentic sources of designs by Charles and Ray Eames, Alexander Girard, and George Nelson. All the designs shown in this book are protected by law. Herman Miller has obtained all rights to make and sell these designs. Also, Herman Miller holds exclusive worldwide manufacturing and distribution rights for these products with the following exceptions:

Charles and Ray Eames, George Nelson, and Alexander Girard—Worldwide distribution rights for furniture in all areas except Europe and the Middle East. For those areas, please contact Vitra.

Isamu Noguchi—Worldwide distribution rights for the Noguchi Rudder Table. Distribution rights for the Noguchi Table in North America and Central America only. For all other areas, please contact Vitra.

Magis—Exclusive distribution rights in the US and Canada. For all other areas, please contact Magis.

© **HermanMiller**, 3D Intelligent, 8Z Pellicle, AO, Action Office, Aeron, Aside, Bubble Lamps, Canvas Office Landscape, Caper, Celle, Cosm, Co/Struc, Daisyone, Distil, Eames, Eco-Dematerialized, Embody, Envelop, Ethospace, Exclave, Fine-Tune, FlexFront, Flo, Formcoat, Formwork, Ground Cloth, Intent, Kinemat, Layout Studio, Lino, Live Unframed, Living Office, Maharam, Meridian, Mirra, Motia, Nelson, Pari, Pellicle, Perspectives, Plex, PostureFit, PostureFit SL, Public Office Landscape, Sayl, Setu, Striad, Tu, Ubi, Verus, Wishbone, Y-Tower and Zeph are among the registered trademarks of Herman Miller, Inc., and its owned subsidiaries.

™ About Face, AireWeave, Airia, Ambit, Asari Chair by HermanMiller, Backfit, Bublelactack, Burdick Group, Butterfly Back, Canvas Vista, Cellular Suspension, Commend, Compass, Connect, DOT, Duracare, Durawrap, EnhancedAccess, Everywhere, Flex-Edge, Flute, Harmonic, Headway, Herman Miller Select, Hopsak 2, Iota, Keyless Entry, Latitude, Logic Mini, Logic Power Access Solutions, Lyris, Lyris 2, Made-to-Measure Storage, Mora, Multiscrim, Nevi, OE1, OE1 Workspace Collection, Overlay, Pixelated Support, Pronta, Renew, Sense, Soft Pad, Stackable, Stackable Storage, Swoop, Thrive, Tone, TriFlex, Twist and Wireframe are among the trademarks of Herman Miller, Inc., and its owned subsidiaries.

SM Herman Miller Options is among the service marks of Herman Miller, Inc.

AAP™ is a trademark of Extron Electronics.

Alexander Girard® is a registered trademark of The Alexander Girard Estate.

Chemsurf® is a registered trademark of Wilsonart International.

Corian® is a registered trademark of E. I. du Pont de Nemours and Company Corporation.

Crypton® is a registered trademark of Crypton, Inc.

DACRON® is a registered trademark of INVISTA S.a r.l.

Danzer® is a registered trademark of Danzer Holding AG.

Decora® is a registered trademark of Leviton Manufacturing Co., Inc.

Edelman® Leather is a registered trademark of Edelman Leather, Inc.

Extron® is a registered trademark of RGB Systems, Inc.

FENIX NTM® is a registered trademark of Arpa Industriale S.p.A.

FLEXNET™ is a trademark of Milliken & Company.

Floor Saver Glide® is a registered trademark of Carpin Manufacturing, Inc.

Forest Stewardship Council® is a registered trademark of the Forest Stewardship Council A.C. (FSC). We are FSC® certified (FSC® C102895).

FSC® is a registered trademark of the Forest Stewardship Council A.C. (FSC).

Geiger® is a registered trademark, and Bumper™, Saiba™, and Ward Bennett™ are trademarks, of Geiger International.

Hang-It-All® is a registered trademark of Lucia Eames Demetrios, d.b.a. Eames Office.

Holophane® is a registered trademark of Holophane.

Ingeo™ is a trademark of Cargill Dow LLC.

iPad® and Mac mini® are registered trademarks of Apple Inc.

Leviton® is a registered trademark of Leviton Manufacturing Co., Inc.

LifeSize® is a registered trademark of LifeSize Communications, Inc.

Logitech G® is a registered trademark of Logitech International S.A.

Magis®, Bombo®, and Me Too® are registered trademarks of Magis S.p.A.

MicrobeCare™ is a trademark of Parasol Medical LLC.

Microsoft® and Natural® Keyboard are registered trademarks of Microsoft Corporation.

Noguchi® and the Noguchi table configuration (trade dress) are registered trademarks, and Rudder Table™ is a trademark, of The Isamu Noguchi Foundation and Garden Museum.

Place Textiles® is a registered trademark of Place Textiles.

Sunbrella® is a registered trademark of Glen Raven, Inc.

SuperSeat™ is a trademark of Dahti Seating, a division of ITW.

Valor™ is among the trademarks owned by Nemschoff, Inc.