

# August Virtual Horse Show

## English Equitation (3 Gaited)

Show Date: 08-01-2020

w w w . H o r s e S h o w P a t t e r n s . c o m

w w w . H o r s e S h o w P a t t e r n s . c o m

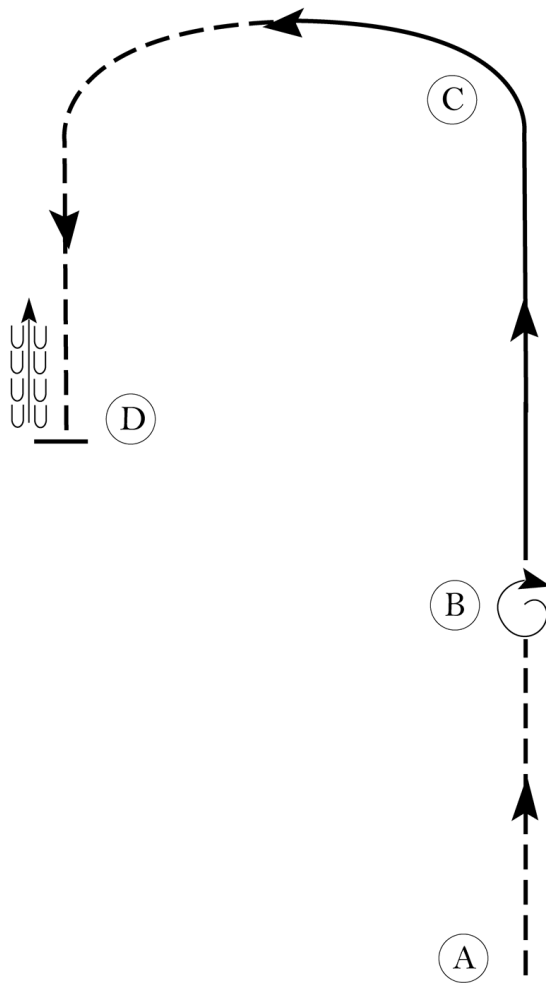

Be ready at A.

1. Posting trot on the left diagonal from A to B.
2. Stop at B and turn on the forehand 360 degrees to the right.
3. At B, canter on the right lead.
4. At the top of the arc, transition to the posting trot to D.
5. Stop and back approximately one horse length at D.

Exit at a sitting trot.

Walk	-----
Trot	- - - - -
Extended Trot	— — — — —
Canter	— — — — —
Leg Yield	
Lead Change	— / —
Back	← ← ← ← ←
Marker	(B)
Sidepass	← ← ← ← ←
Hand Gallop	— — — — —

[HSE/2-22]

Pattern Provided by:

SSC

# August Virtual Horse Show

## English Equitation (Walk Trot)

Show Date: 08-01-2020

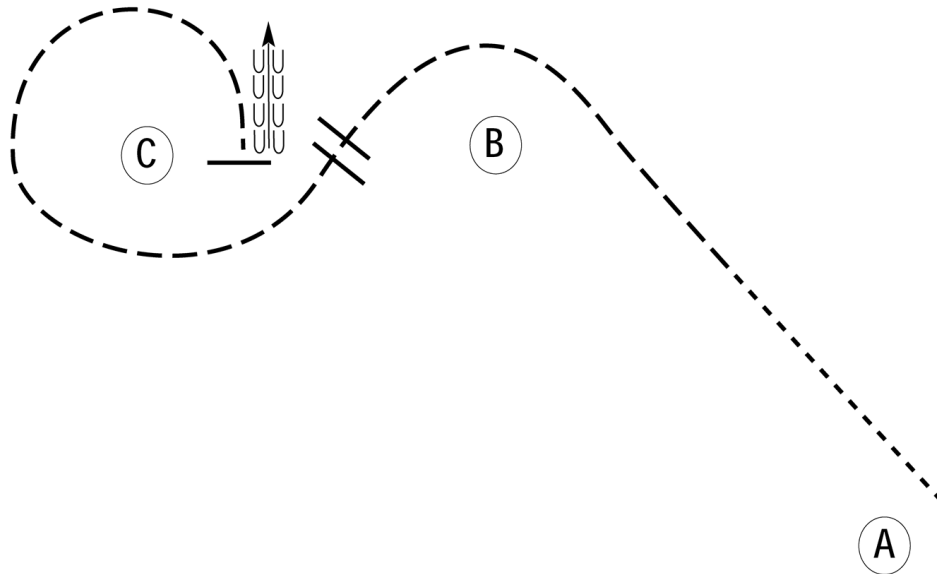

Be ready at A.

1. Walk halfway to B.
2. Sitting trot to B.
3. Posting trot on the right diagonal from B, halfway to C.
4. Change diagonals halfway to C.
5. Posting trot on the left diagonal to and around C.
6. Stop at C.
7. Back approximately one horse length.

Walk	-----
Trot	- - - - -
Extended Trot	- - - - -
Canter	—————
Leg Yield	
Lead Change	↘ ↙
Back	← ← ← ← ←
Marker	⊙
Sidepass	← — — — — →
Hand Gallop	— / — / — / — / — /

[HSE/WT-12]

Pattern Provided by:

SSC

# August Virtual Horse Show

## Mini/Pony Obstacle Course

Show Date: 08-01-2020

www.HorseShowPatterns.com

www.HorseShowPatterns.com

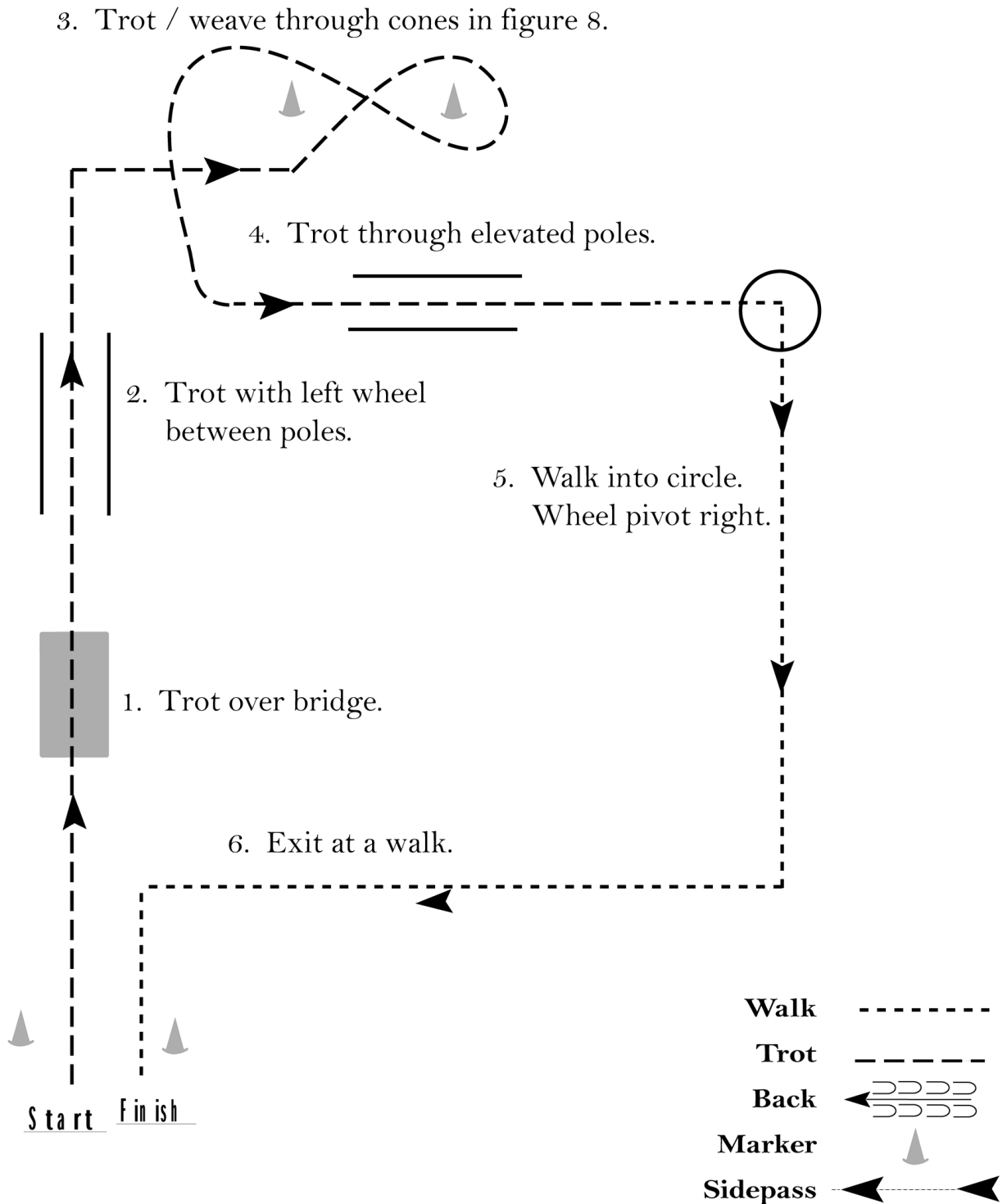

[MHP/DO-4]

Pattern Provided by:  
**SSC**

# August Virtual Horse Show

## Ranch Riding

Show Date: 08-01-2020

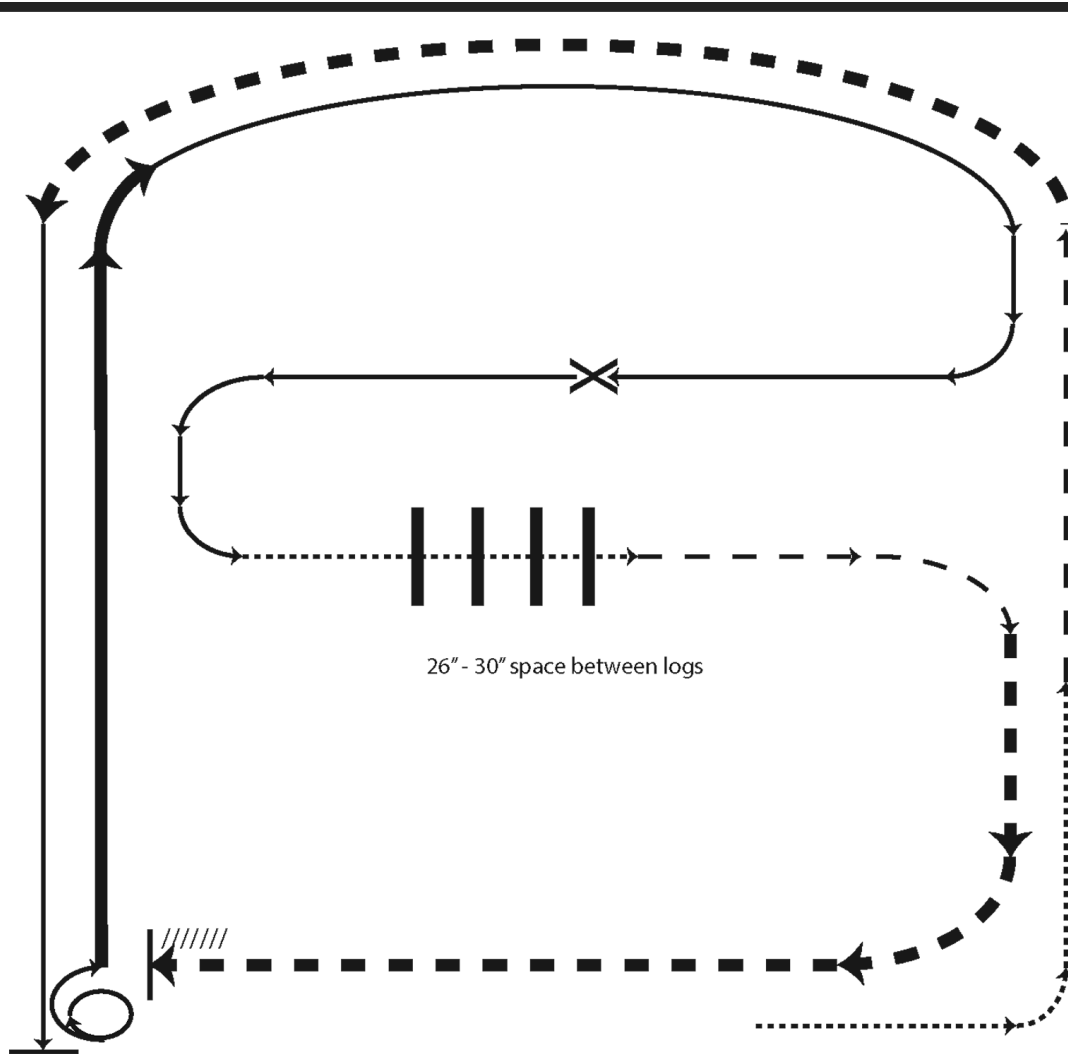

- X Lead Change
- Walk
- - - Trot
- - - Ext Trot
- — — Lope
- — — Ext Lope
- /////// Back

1. Walk
2. Trot
3. Extended trot
4. Left lead lope
5. Stop, 1 1/2 turn right
6. Extended lope
7. Collect to working lope-right lead
8. Change leads (simple or flying)
9. Walk
10. Walk over logs
11. Trot
12. Extended trot
13. Stop and back

[RR/AQHA-2]

Pattern Provided by:

SSC

# August Virtual Horse Show

## Showmanship All Classes

Show Date: 08-01-2020

w w w . H o r s e S h o w P a t t e r n s . c o m

w w w . H o r s e S h o w P a t t e r n s . c o m

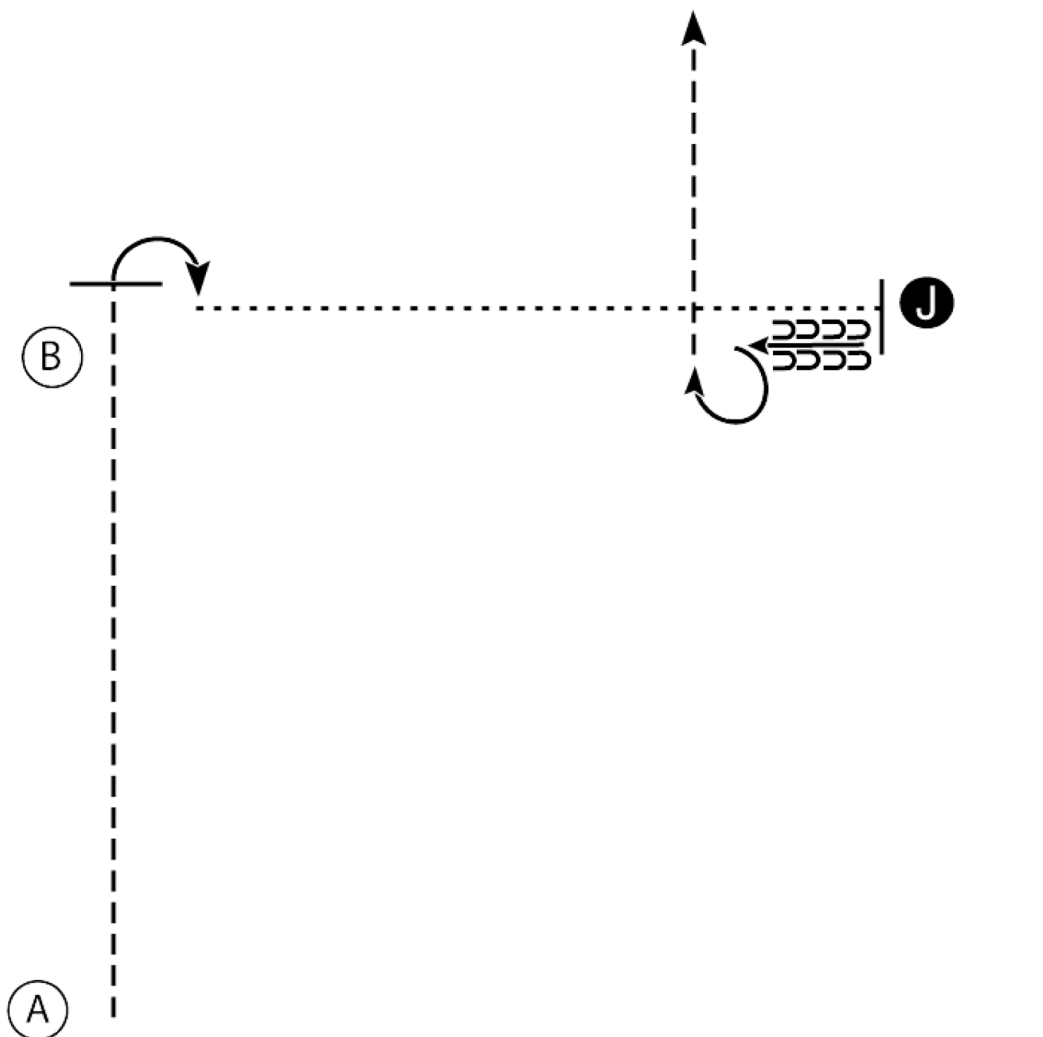

1. Begin at A. Trot from A past B
2. Stop and perform a 90 degree turn
3. Walk to the Judge, stop and set up for inspection
4. When dismissed back one horse length and perform a 270 degree turn
5. Trot to the line-up

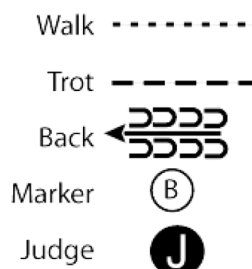

[S/WT-3]

Pattern Provided by:

SSC

# August Virtual Horse Show

## Trail (All Classes)

Show Date: 08-01-2020

w w w . H o r s e S h o w P a t t e r n s . c o m

w w w . H o r s e S h o w P a t t e r n s . c o m

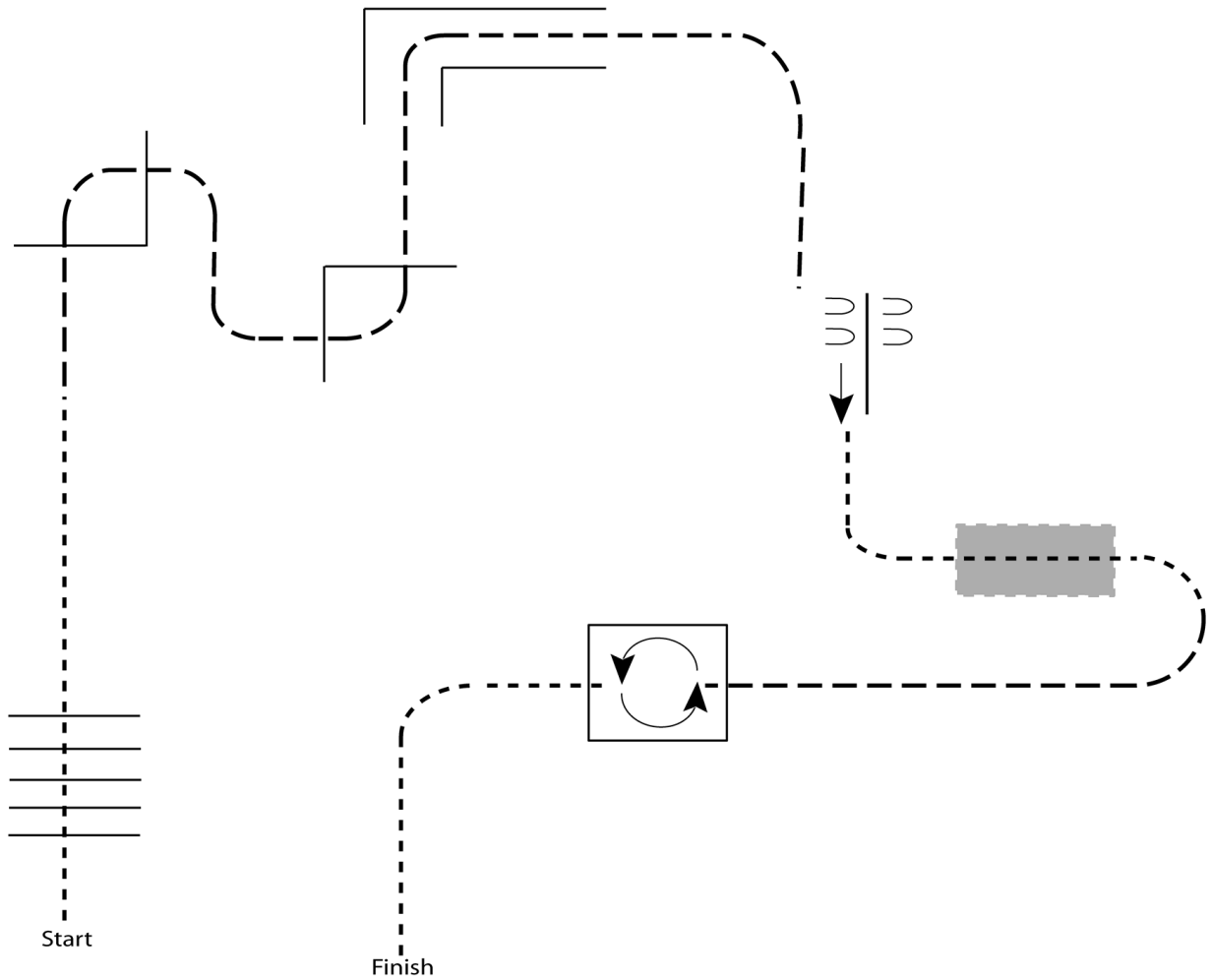

1. Walk over poles
2. Jog over poles
3. Jog through chute
4. Sidepass over log to the right
5. Walk over bridge
6. Jog into box and perform a 360 degree turn to the left
7. Walk out of box to finish

Walk	-----
Jog	- - - - -
Extended Jog	- - - - -
Lope	—————
Leg Yield	
Lead Change	— / —
Back	← ← ← ← ←
Marker	Ⓚ
Sidepass	← ——— →

[T/WT-5]

Pattern Provided by:

SSC

# August Virtual Horse Show

## Horsemanship (3 Gaited)

Show Date: 08-01-2020

w w w . H o r s e S h o w P a t t e r n s . c o m

w w w . H o r s e S h o w P a t t e r n s . c o m

1. Jog A to B.
2. Stop at B and perform a 180 degree turn to the right on the hindquarters.
3. Jog a circle to the left.
4. At B lope a circle to the right on the right lead.
5. Stop at B and perform a 180 degree turn to the left.
6. Jog B to C.
7. Stop at C.

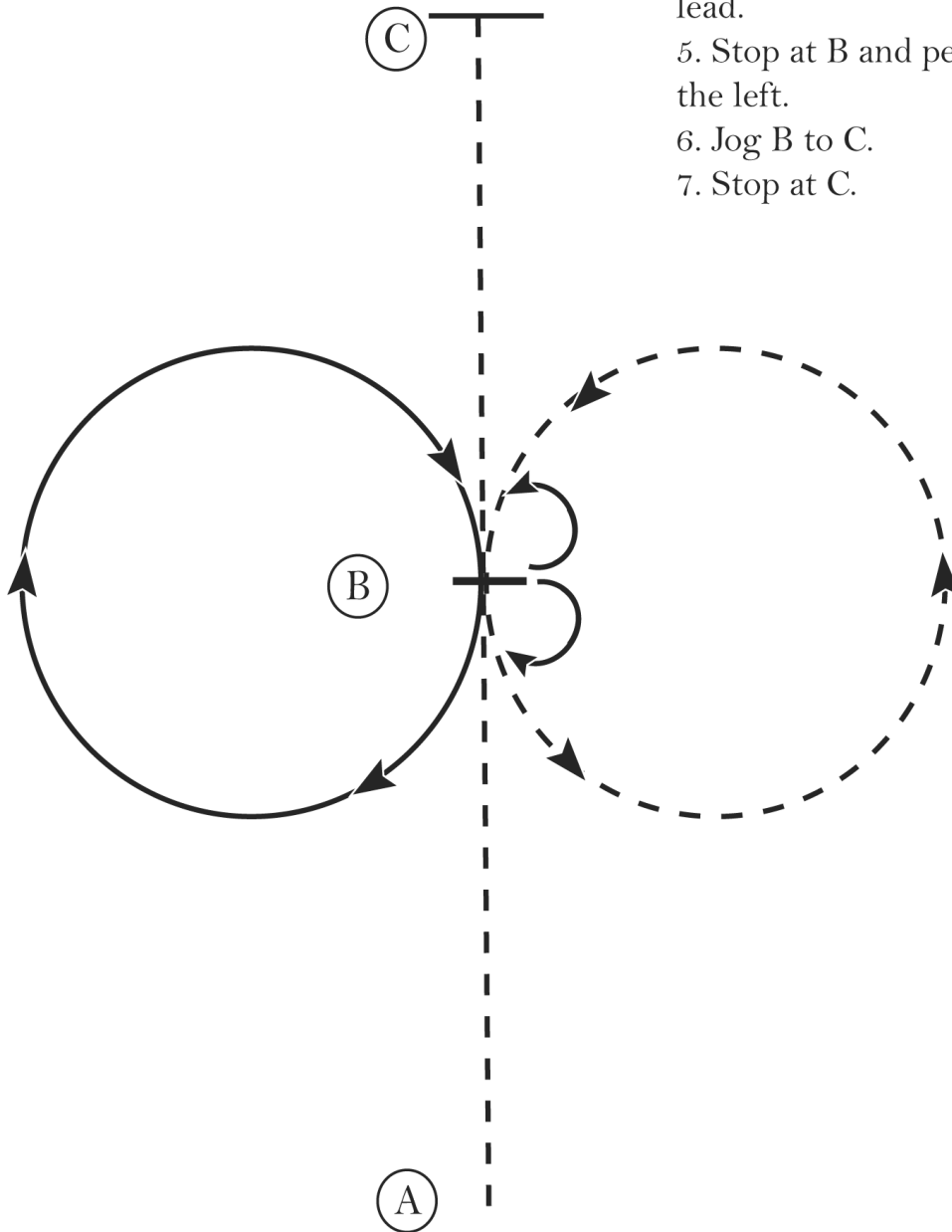

Walk	.....
Jog	- - - - -
Extended Jog	— — — — —
Lope	—————
Leg Yield	
Lead Change	↘
Back	←←←←← ←←←←←
Marker	(B)
Sidepass	←- - - - -←

[WH/1-10]

Pattern Provided by:

SSC

# August Virtual Horse Show

## Horsemanship (Walk Jog)

Show Date: 08-01-2020

www.HorseShowPatterns.com

www.HorseShowPatterns.com

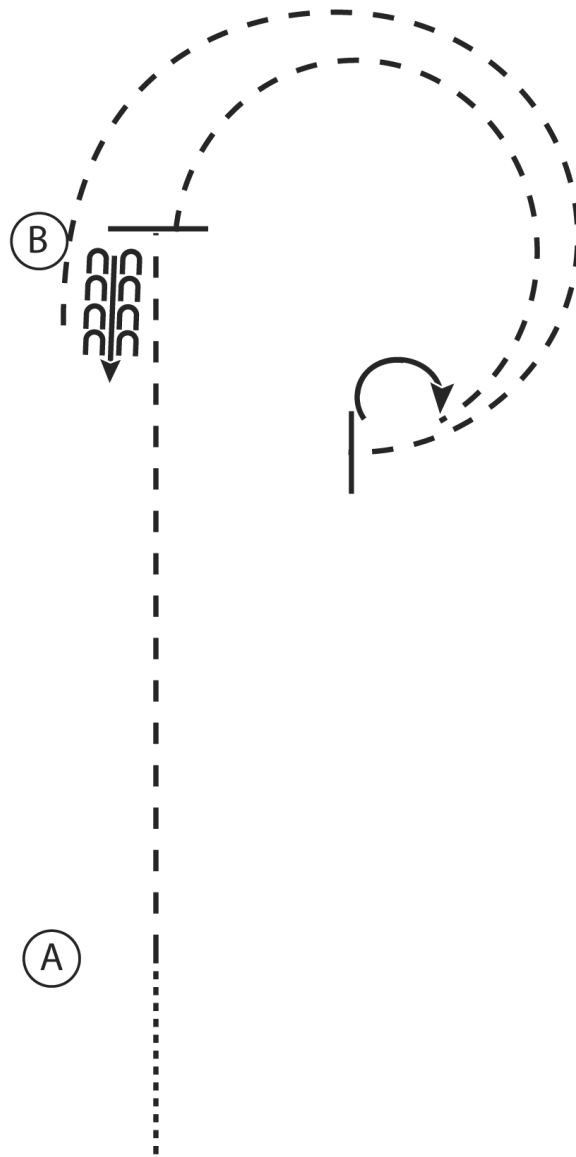

1. Walk to A
2. Jog A to B
3. At B stop and back
4. Jog 3/4 circle to the right
5. Stop and perform a 180 degree turn to the right on the hindquarter
6. Jog a circle back to B
7. Stop at B

Walk	.....
Jog	- - - - -
Extended Jog	- - - - -
Lope	—————
Leg Yield	
Lead Change	——— ———
Back	←←← ←←←
Marker	(B)
Sidepass	←- - - ->

[WH/WT-12]

Pattern Provided by:

SSC