

Chem-Nut Equipment and Supply

Your one stop shop for all your equipment, nuts, bolts, chemicals, and automotive supplies



2019CATALOG

Table of Contents

ABRASIVES	122-134	FASTENERS CONTINUED	
ABSORBENTS	135-136	Cabinet Screws	50
ALIGNMENT MACHINE	172-173	Screws, Pins, Keys, Threaded	51
Cemb		Rod, Studs, & Rings	
BRAKE FITTINGS	29	Metric Fasteners	52-53
BRAKE LINES	28-29	FASTENERS-SPECIALTY	33-37
BRAKE TUBING	29	FILTERS-PRO GAUGE	16-20
BRASS	54-56	Oil Filters	16-17
CHEMICALS	7-14	Air Filters	17-20
Aerosols	7-9	Cabin Air Filters	20
Petro	7	FUSES	30-31
Permatex	8	GENERAL SHOP SUPPLIES	24
CRC	8-9	Little Trees Air Fresheners, Latex Gloves,	
Master, Sprayway, & PB Blaster	9	Razor Blades, Electrical Tape, Grease, Shop	
Drivability Chemicals	10-13	Towels, Hand Cleaner, & JB Weld	
Petro	10-12	HEAVY DUTY TRUCKING	57-71
Power Services	12	Brass	57-68
Lucas	13	Brake Parts & Misc. Parts	69-70
Part Washer & Windshield Washer	13	Trailer Lighting	70-71
Brake Fluid & Power Steering Fluid	14	HOSES	25-27
ELECTRIC	72-121	HOSE CLAMPS	27-28
Heat Shrink Connectors	72-78	LIGHTING	31-32
Standard Solderless Terminals	79-88	Sealed Beam	31
Heat Shrink Tubing	89-101	Bulbs	31-32
Battery Terminals & Accessories	102-113	Batteries & Flashlights	32
Wire & Cables	114-115	LIFTS	140-151
Cable Ties	116-118	Rotary	140-147
Cable Clamps	119	Challenger	148-151
Split Loom	120-121	NEW & USED CAR DEALERSHIP	137-139
FASTENERS	38-53	PRODUCTS-MALCO	
Nuts	38-41	SPRAY PAINT	15
Washers	41-42, 44	TIRE REPAIR	21-23
Hex Cap Screws	43-45	TIRE CHANGERS &	152-171
Bolts	45-46	WHEEL BALANCERS	
Socket Screw	47	Coats	152-161
Collars & Hex Keys	48	Cemb	162-171
Machine & Tapping Screws	48-49	WIPER BLADES	25
Drywall, Wood, &	50		

Chem–Nut Equipment & Supply

Our Story

Our founder and owner, Dave Doehler, started the company in the year 2000 from the basement of his home. He believed there was an opportunity to better serve the automotive, construction and trucking industries. He focused on offering top notch service and reasonable prices on equipment and supplies. He began selling his products to local shop owners and construction companies. If there was anything you needed, he would work hard to get it for you. This is the solid foundation that the company was built on.

We are not your average parts store type. We can offer your shop a complete **Inventory Management Program** that will free up your time to concentrate on what you do best, servicing your customers. We will come by on a weekly or bi-weekly basis and check the quantity of supplies you have on hand, such as your chemicals, tire patches, nuts, bolts, fuses, wiper blades, filters, etc. to make sure that you never run out. You do not have to worry about ever not being able to finish a job because you forgot to re-order brake lines.

We not only can supply your shop with all of your supplies, but also your equipment. We carry both new and used lifts, tire changers, wheel balancers, etc. We are an authorized installer and distributor for Rotary Lifts and Challenger Lifts. We can repair all of your tire changers and wheel balancers. We are a one-stop shop for all of your shop needs.

ORDER FORM

Bill To:

Name or Company

Contact

Address

State

Zip Code

Fax order to 508-256-7890

Phone #

Part #	Description	Quantity



Brake Cleaner

- Stops annoying brake squeal and chatter
- Provides cleaning and high pressure flushing for brake and clutch materials, as well as hard parts
- Quick drying with no residue
- Removes grease and oil for quick inspection

Part Number PBC265



Throttle Plate Cleaner

- Removes deposit from throttle plate and throttle body
- Removes build-up on the idle control solenoid and helps clear partially blocked air passages
- Improves fuel mileage
- Cleans air intake system
- Oxygen sensor, catalytic converter safe

Part Number PTP753



Rust Penetrant

- Quickly helps to remove and penetrate rust, grime, grease, and similar substances
- Quickly loosen frozen fasteners
- Lessens labor time on "stuck" fasteners and bolts
- Leaves behind a protective film that helps prevent further corrosion

Part Number PRP252



Silicone Spray

- Eliminates unwanted noises
- Prevents cracking of rubber molding
- Reduces friction of metal and non-metal parts
- Ensures the ease of operation of sticking parts
- Penetrates the smallest cracks

Part Number PSS251



Non-Chlorinated Brake Cleaner

- Stops annoying brake squeal and chatter
- Provides cleaning and high pressure flushing for brake and clutch materials, as well as hard parts
- Quick drying with no residue
- Removes Grease and oil for quick inspection

Part Number PNC684



Carburetor Cleaner

- Designed to quickly cut through varnish, gum, and residues
- Helps eliminate stalling
- Improves fuel efficiency
- Cleans automatic choke
- Cleans carburetors with no disassembly required
- VOC compliant

Part Number PCC253



Chain Lube

- When applied to a surface, it creates a lubricating film which is dry to the touch and does not fling off
- For standard and "O" ring chains
- Excellent rust protection
- Repels dirt and water
- Contains TEFLON and Moly

Part Number PCL263



White Lithium Grease

- Reduces grinding friction wear
- Easy to apply
- Guards against corrosion and rust
- Never gums or cakes
- Lubricates metal-to-metal and metal-to-plastic moving parts
- Sets up quickly to thick coating

Part Number PWG268



Permatex Disc Brake Quiet

- Stops brake squeal by dampening vibration at caliper/brake pad interface
- Provides tighter fit and allows for easier disassembly
- Protects against corrosion
- Compatible with anti-lock brake systems

Part Number PER127MA



Permatex High Tack Gasket Spray

- Red colored, all-purpose sealant that holds even the heaviest of gaskets in place during assembly
- Seals and bonds rubber, cork, paper, felt, and metal gaskets
- Sets quickly to a very tacky film

Part Number PER99MA



Permatex Battery Cleaner

- Spray it on and wash corrosion off
- Works in just three minutes
- Penetrates and removes corrosion, dirt and grime instantly
- Cleans all types of storage batteries and attachments in emergency power supply system

Part Number PERSA8



Non-Chlorinated CRC Brake Clean

- The Brake Cleaner to use where compliance calls for a chlorine-free product
- Formulated to quickly remove brake fluid, grease, oil, and other contaminants from brake linings & pads

Part Number CRC05088



CRC Brake Clean California Emissions

- The Brake Cleaner to use where compliance calls for a chlorine-free product
- Formulated to quickly remove brake fluid, grease, oil, and other contaminants from brake linings & pads

Part Number CRC05084

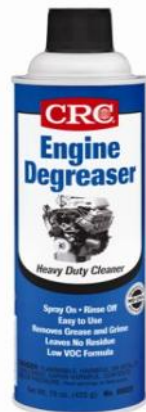

CRC Engine Degreaser

- Engine Degreaser quickly lifts grease & grime off engines for cooler more efficient running
- Easy to use - just spray on & rinse off
- Leaves no residue

Part Number CRC05025



CRC Carburetor Cleaner

- A carb & choke cleaner that is designed to maximize carburetor performance
- Quickly dissolves carburetor deposits such as gum, sludge & varnish to improve fuel system performance & enhance fuel economy

Part Number CRC05079



CRC Throttle Body & Air-Intake Cleaner

- Throttle Body & Air Intake Cleaner cleans gum and varnish from the throttle valves and throttle body for easier starting and smoother engine performance

Part Number CRC05078



CRC Electric Parts Cleaner

- An aggressive cleaner specifically for electric motors, transformers and machinery
- Non-flammable formula dissolves grease, oil, dirt, & wax without having to remove parts

Part Number CRC05018



CRC Freeze-Off Super Penetrant

- A unique formula that immediately drops the temperature of the area in direct contact with the spray
- The freezing effect cracks rusted surfaces, allowing Freeze-Off® to reach deeper & work more effectively than other penetrants
- Low VOC Formula.

Part Number CRC 05002



Master Brake Cleaner

- Stops annoying brake squeal and chatter
- Provides cleaning and high pressure flushing for brake and clutch materials, as well as hard parts
- Quick drying with no residue
- Removes grease and oil for quick inspection

Part Number BCN20A



Sprayway Citrus Cleaner

- Cleans, deodorizes and de-greases parts, work areas, walls, and floors
- Removes dirty hand prints, scuff marks, bathtub rings, soot, grease, smoke film, oil, dust, lipstick, crayon marks, etc.
- Easily wipes down washable painted surfaces, window sills, venetian blinds, and tile

Part Number SP985



CRC Mass Air Flow Sensor Cleaner

- The first product specifically developed to clean mass air flow sensors
- Designed with advanced Co-zol® technology
- Increases horsepower & improves air/fuel ratio and MPG

Part Number CRC05110



Master Starting Fluid

- Use for Quick Starts
- Heavy Duty Applications
- Twice the Ether for faster, surer starts
- For all gas and Diesel Engines

Part Number SFP16



Sprayway Glass Cleaner

- The most versatile glass cleaner available - cleans glass, windows, mirrors, windshields; enamel surfaces, chrome, tile, porcelain and other hard surfaces
- Dissolves dirt, grease, grit, and grime
- Heavy-duty foam clings to vertical surfaces
- Guaranteed to leave no film

Part Number SP50



PB Blaster

- Quickly breaks loose the surface tension of frozen parts
- Protects against further rust and corrosion
- Easy to use
- Quick working formula

Part Number BE16PB



Transmission Conditioner

- Blend of detergent, anti-oxidant, anti-wear, viscosity improving, corrosion inhibiting, and seal conditioning additives that provide extra protection
- Keeps seals soft and pliable
- Prevents leaks
- Revitalizes transmission fluid
- Maintains smooth shifting

Part Number PTC041



Radiator Fast Flush

- Removes deposits of calcium, magnesium, iron, and silicates
- Designed for cast iron, aluminum, and alloys
- Neutralizing not necessary
- Will not harm cooling systems
- Improves Cooling efficiency

Part Number PRF116



Rust Inhibitor

- Soluble inhibitor with emulsifiers and anti-foam agents designed to protect and lubricate all the components of the cooling system
- Prevents rust and corrosion
- Lubricates water pump
- Stops pump squeaks
- Prevents water pump seal leaks

Part Number



Power Steering Concentrate

- Balanced blend of detergent, anti-oxidant, anti-wear, viscosity improving, inhibiting, and seal conditioning additives
- Keeps seals soft and pliable
- Maintains smooth pump and cylinder operation
- Revitalizes power steering fluid

Part Number PPS036



Oil Treatment

- Viscosity improving, heat stable, special lubricant with rust inhibitors and anti-wear lubricants
- Improves compression
- Reduces engine temperature
- Controls oil thinning
- Maintains oil pressure
- Reduces oil consumption

Part Number POT034



Friction Free

- Extreme pressure additive that reduces the amount of work an engine must perform
- Maintains oil film
- Protects against cold starts
- Keeps engine cleaner and extends engine life
- Stops heat damage and seizure

Part Number PFF031

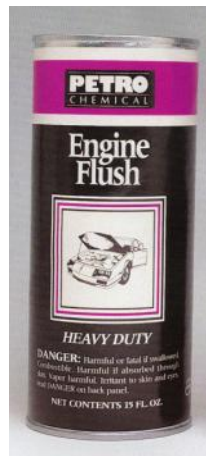

Engine Flush

- Assists in the removal of sludge and other contaminants prior to changing a vehicle's oil
- Washes away gums, acids, and varnish from the crankcase, oil lines, oil pump screen, oil return ports, and the engines moving parts
- Frees hydraulic valve lifters

Part Number PEF038



Tune Up

- Reduces the types of deposits that cause noisy lifters, stuck valves, sticking rings, and similar problems
- Removes sludge and varnish
- Improves engine performance
- Promotes even wear of friction components

Part Number PTU030



Conditionaire 2005

- Air conditioner refresher which helps eliminate odors caused by fungi and bacteria, restoring evaporator to like-new condition
- Cleans and freshens the evaporator core
- Deodorizes the passenger compartment
- Reduces repair costs

Part Number PCA200



Gas Treatment

- Contains corrosion inhibitors, carburetor cleaners, fuel system dispersants and detergents, anti-icers, upper cylinder lubricants, exhaust valve seat protectors, and moisture removers
- Provides complete protection of the fuel system under any condition

Part Number PGT020



Gas Treatment/Octane Booster

- Unique blend of chemicals that protects, lubricates, and cleans the entire fuel system from fuel tank to combustion chamber
- Ability to emulsify water and carry it to the combustion chamber where it is burned
- Coats and treats fuel tank and lines
- Provides immediate power boost

Part Number PGT070



Diesel Fuel Conditioner

- Designed to disperse oxidation residues to prevent filter plugging and injector deposits in diesel engines
- Promotes cleaner, more efficient usage of fuel, prolongs injector life
- Eliminates moisture to prevent fuel line freeze up

Part Number PDF071



Fuel Injector Cleaner

- Powerful blend of solvents with the ability to cut through resins, gums, and varnish
- Aids in the lubrication of fuel pumps and fuel injectors as it cleans stubborn deposits
- Improves engine performance

Part Number PFI075



Formula 400

- Formulated to clean plugged fuel injectors without removing the fuel rail
- Improves engine power and efficiency by eliminating hard carbon deposit build-up
- Improves fuel mileage
- Improves starting, high speed performance, and smoother idling

Part Number PFI400



Engine Maintenance Kit

- Combination of three fuel system and engine treatment formulas designed to keep vehicles trouble-free
- Increases fuel mileage
- Decreases emissions
- Cleans fuel injectors
- Eliminates carbon knock

Part Number PEM330



Induction System Kit

- Designed to completely clean an engine's fuel system and air induction system
- Improves fuel mileage
- Cleans air intake system
- Cleans idle control solenoid

Part Number PIS005

Cooling System Reconditioning Kit



- Designed to completely cleanse and condition the engine's cooling system
- Stops pump squeaks
- Will not harm cooling system
- Protects entire cooling system

Part Number PFK003

Inject-A-Kleen Extra Kit



- Contains an aerosol can, which is used for direct rail cleaning, and a gas tank additive, designed to clean the balance of the fuel system
- Oxygen sensor safe
- Improves fuel mileage
- Will restore dirty, fouled injectors to OEM specifications

Part Number PRF116

Diesel Fuel Supplement + Cetane Boost



Part #	Size	Treats
1016-06	16 oz.	50 gal
1025-12	32 oz.	100 gal
1080-06	80 oz.	250 gal

- Prevents fuel gelling in temps as low as -40F
- Prevents fuel filter from icing
- Boosts cetane up to 4 numbers

Diesel Kleen + Cetane Boost



Part #	Size	Treats
3016-06	16 oz.	50 gal
3025-12	32 oz.	100 gal
3080-06	80 oz.	250 gal

- Increase MPG by up to 8%
- Loaded with cetane, detergency, and lubricity additives to enhance engine performance



Arctic Express Diesel Fuel Anti-Gel

- Provide better cold weather operability than blending with kerosene or No. 1 diesel fuel and costs 80% less
- Keeps fuel liquid during extended engine shutdowns
- 2.5 gallons

Part Number 7050-02



Diesel 911

Part #	Size	Treats
8025-12	32 oz.	30 to 75 gal
8080-06	80 oz.	100-200 gal

- De-ices frozen fuel filters
- Reliquefies gelled fuel in minutes
- Removes water from fuel system
- Prevents fuel filter icing



Bio Kleen Diesel Fuel Biocide

- Effective as a "quick-kill" biocide and for long-term diesel fuel maintenance
- Kills microbes (bacteria and fungi) that grow in dispersed and free water associated with diesel fuels
- Prevents fuel-filter plugging – helps prevent fuel system failures
- 16 oz.

Part Number 9016-06



Clear Diesel Fuel & Tank Cleaner

Part #	Size
9225-06	32 oz.
9241-04	96 oz.

- Advanced fuel tank cleaning technology that has been proven effective in hundreds of fleet, marine, & construction applications
- Keep diesel fuel fresh



Heavy Duty Oil Stabilizer

Part #	Size
10001	Qt.
10002	Gal.

- Formulated to eliminate dry starts and reduce friction, heat and wear in any type of engine
- Increases power and MPG
- Use in gear oil to stop leaks, reduce operating temperatures and increase the life of gear oil



Fuel Treatment

- In Quart Size
- Increase power and fuel mileage
- Lowers exhaust emissions
- Cleans and lubricates the carburetor and injectors
- Neutralizes the harmful effects of low sulfur diesel fuel

Part Number 10003



Red 'N' Tacky #2 Grease

- Red lithium 12-OH grease
- 14 oz. container
- Rust and oxidation inhibitors
- Water resistant
- Excellent mechanical stability
- Long Storage Life

Part Number 10005



Gun Oil

- 2 oz. container
- Prevents jamming and overheating in large machine guns and high powered rifles
- Use on fishing reels
- Excellent household oil
- Excellent for long-term storage

Part Number 10006



Power Steering Stop Leak

- 12 oz. container
- Guaranteed to stop leaks in power steering units
- Corrects rack and pinion problems

Part Number 10008



Transmission Fix

- 24 oz. container
- Non-solvent formula that stops slip, hesitation, and rough shifting in worn transmissions
- Eliminates most seal leaks
- Use in any transmission for preventative maintenance

Part Number 10009



Parts Washing Fluid-Master

- 5 gallon pail with spout
- Why Pay a Monthly Fee?

Part Number PWF-5



Windshield Washer Fluid Concentrate-Super S

- California & OTC state compliant

Part Number SUS112

Brake Fluid by Master**Heavy Duty – Dot 3 Packaged in Plastic Bottle/Drum**

Part #	Size	Description
FH-12	12 oz.	Dot 3 Brake Fluid
FH-32	Quart	Dot 3 Brake Fluid
FH-128	Gallon	Dot 3 Brake Fluid
FH-640	5 Gallon	Dot 3 Brake Fluid

Super Heavy Duty – 450 Degree High Temperature

Part #	Size	Description
FF12P	12 oz.	Hi-Temp Brake Fluid
FF32P	Quart	Hi-Temp Brake Fluid
FF168P	Gallon	Hi-Temp Brake Fluid

DOT 4 for BMW, Mercedes & Most German, English, Italian & Japanese Vehicles

Part #	Size	Description
BF4-12	12 oz.	Dot 4 Brake Fluid
BF4-32	Quart	Dot 4 Brake Fluid

Silicone – Dot 5

Part #	Size	Description
DS-12	12 oz.	Dot 5 Brake Fluid
DS-32	Quart	Dot 5 Brake Fluid

Power Steering Fluid by Master**Packaged in Plastic Bottles**

Part #	Size	Description
PSF-12	12 oz.	Fluid
PSF-32	32 oz.	Fluid
PSF-128	Gallon	Fluid
PSL-12	12 oz.	Sealer
HPS-12	12 oz.	For Honda/Acura



SPRAY PAINT (16 oz.)



Armor #	Description	Krylon #
A04	Universal Gloss Black	1601
A05	Chinese (Cherry) Red	2101
A13	Flat White	1502
A14	Ultra Flat Black	1602
A15	Bright Silver	1401
A16	Bright Yellow	1806
A17	Clear Plastic	1301
A22	Gloss White	1501
A30	Dull Aluminum	1403
A50	Semi-Gloss Black	1613
A81	Red Primer*	1317
A82	Gray Primer*	1368
A83	Black Primer*	1366
A95	Red-Orange, Fluorescent	3101

*Sandable Lacquer

Engine Enamel

Armor #	Description	Krylon #
A24	GM Alpine Green	2013
A84	Universal Black	1612
A85	Chevy Orange	2405
A86	Ford Red	2106
A87	Ford Blue	1909
A89	Ford Dark Blue	1923
A90	G.M. Blue	1930
A91	Chrome Aluminum	1404
A92	Universal Gray	1611
A93	Chevy Blue	1908
A96	Cummins Beige	1317

Construction Equipment & Farm Implement

Armor #	Description	Krylon #
A06	John Deere Green	1817
A07	John Deere Yellow	1816
A08	Caterpillar Yellow	1805
A09	International Red	1818

High Heat Paint (Withstands 1200 Degree F)

Armor #	Description	Krylon #
A102	High Heat Aluminum	1402
A105	High Heat White	1505
A114	High Heat Black	1614

Master Chrome

Armor #	Description
CE99	Master Chrome

Master Gold



Armor #	Description
GL100	Master Gold

Cast Iron (Gives Cast Iron a New Look)

Armor #	Description
CI-16	Cast Iron Gray

Cast Aluminum Gray (Gives Cast Iron a New Look)

Armor #	Description
AC-16	Cast Aluminum

Spray Paint



Krylon #	Description
1301	Acrylic Crystal-Clear
1315	Primer-White
1316	Primer-Black
1317	Primer-Ruddy Brown
1318	Primer-All-Purpose Gray
1401 (14012)	Bright Silver
1402	High-Heat Aluminum
1403	Dull Aluminum
1501	Glossy White
1502	Flat White
1601	Glossy Black
1602	Ultra-Flat Black
1612	Universal Black
1613	Satins Black
1614	High-Heat Black
1618	BBQ Black
1805	New Caterpillar Yellow
1809	School Bus Yellow
1819	Old Caterpillar Yellow
1821	Kubota Orange
1822	Massey Ferguson Red
1909	Ford Blue Engine Paint
2101	Cherry Red
1813	Safety Yellow – OSHA
2410	Safety Orange – OSHA
2320	Gloss White – Fusion
2328	Red Pepper – Fusion
5850	Yellow Solvent Based Marking Paint

Pro Gauge Oil Filters

Pro Gauge spin-on oil filters feature correctly treated media, heat-treated tension springs, a steel double-fluted center core, metal end caps and more. All Pro Gauge filters are built to meet or exceed OEM specifications.



Part #	A/C Delco	Champ	Fram	NAPA	Pennzoil	Purolator	Quaker State	Valvoline	WIX
PGO-1A	PFL1A	PH8A	PH8A	1515	PZ1	L30001	QS8A	VO1	51515
PGO-11	PF962	P824A	CH7329	1398	PZ43	L20011	QS2859B	LC1057	51398
PGO-18	PF2140	PH2904	PH7328	1311	PZ104	L10018	QS7328	VO53	51311
PGO-33	PF24	PH24	PH25	1258	PZ2	L20033	QS25	VO3	51258
PGO-39	PF2053	P829	CH4536	1289	PZ133	L40039	QS4536	LC829	51289
PGO-49	PF12	PH25	PH30	1069	PZ3	L20049	QS30	VO2	51069
PGO-81	PF13	PH253	PH43	1521	PZ7	L20081	QS43	VO6	51068
PGO-84	PF1100	P828	CH2965A	1732	PZ40	L30084	QS2965A	LC828	51732
PGO-85	PF1072	P1072	CH3970	1630	PZ31	L10085	QS3970	VO37	51630
PGO-111	PF47	PH47	PH3387A	1040	PZ9A	L10111	QS3387A	VO16	51040
PGO-193	PF1177	PH2856A	PH3950	1381	PZ106	L10193	QS3950	VO19	51381
PGO-195	PFL400A	PH400	PH3600	1516	PZ19	L20195	QS3600	VO23	51516
PGO-241	PF53	PH2835	PH3614	1348	PZ21	L10241	QS3614	VO25	51348
PGO-252	PF56	PH561	PH2870A	1342	PZ12	L20252	QS2870A	VO15	51088
PGO-257	PF960	PH2815	PH3569	1191	PZ22	L30257	QS3569	VO24	51191
PGO-288	PF1054	LFP784	PH3766	1742	PZ105	L30288	QS3766	VO46	51742
PGO-291	PF963	PH2817	PH3531	1392	PZ18A	L10291	QS3531	VO27	51392
PGO-2222	PF48	PH48	PH10060	7060	PZ167	L12222	QS45518	VO88	57060
PGO-2500	-----	PH500	PH10575	7502	-----	L22500	QS45522	-----	57502
PGO-2821	PF1233	-----	PH2951	-----	PZ26	L22821	QS2951	VO48	51394
PGO-3056	PF968	P825	CH2930	1385	PZ44	L43056	QS2930	LC2930	51385
PGO-4006 (3506)	PF44	PH44	PH3506	1042	PZ48	L14006	QS14006	VO58	51042
PGO-4007	PF61	PH59	PH3675	1522	PZ28	L25288	QS3675A	VO31	51522
PGO-4008	PF2054	P830	CH6351	1371	PZ137	L24008	QS6351	LC830	51371
PGO-4011	PF52	PH51A	PH3980	1036	PZ29	L24011	QS3980	VO55	51036
PGO-4457 (64)	PF1232	PH2827	PH3682	1361	PZ27	L24457	QS3682	VO33	51361
PGO-4459	PF1127	PH2802	PH9688	1064	PZ33	L14459	QS3593A	VO39	51334
PGO-4460	PF2192	PH2869	PH3593A	1334	PZ33	L14460	-----	VO61	51334
PGO-4466	PF2124	PH2861	PH4681	1088	PZ35	L24466	QS4681	VO43	51088
PGO-4476	PF1233	PH2840	PH4967	1394	PZ39	L14476	QS4967	VO40	51394
PGO-4477	PF1233	PH2840	PH4386	1396	PZ38	L14477	QS4386	VO41	51396
PGO-4484	PF1240	PH2702	PH8212	1378	PZ41A	L24484	QS6552	VO60	51378
PGO-4619	PF970C	PH2801	PH3985	1626	PZ30	L14619	QS3985	VO35	51626
PGO-4620 (4610)	PF1127	PH2867	PH7317	1356	PZ109	L14620	QS14610	VO50	51356
PGO-4622 (4612)	PF1237	PH2876	PH6607	1365	PZ37	L14622	QS14612	VO54	51365
PGO-4631	PF1218	PH1218	PH5	1060	PZ45	L34631	QS5	VO56	51060
PGO-4651	PF1250	PH820	PH2	1372	PZ42	L24651	QS2	VO47	51372
PGO-4670	PF13	PH253	PH16	1085	PZ34	L14670	QS16	VO45	51348
PGO-4756	PF2145	P845	CH6847	1246	PZ54	L34756	QS6847	VO70	51246
PGO-4757	PF2146	P843	CH6848	1145	PZ53	L44757	QS6848	VO62	51145
PGO-4758	PF2114	P833	CH7073	1185	PZ144	L14758	QS7073	LC833	51185

Continued on Next Page

CONTINUED-Pro Gauge Oil Filters

Part #	A/C Delco	Champ	Fram	NAPA	Pennzoil	Purolator	Quaker State	Valvoline	WIX
PGO-4798	PF2141	P2902	CH7732	1170	PZ147	L44798	L44798	LC2902	57170
PGO-4872	PF2174	LFP2286	PH3786	1734	PZ49	L44872	QS44872	VO63	51734
PGO-5230	PF2221	PH2005	PH8316	1315	PZ51	L25230	QS25230	VO59	51315
PGO-5234	-----	P3986	CH9954	7186	-----	L35234	-----	VO85	57186
PGO-5247	PF2248G	P8170	CH8081	1223	PZ63	L25247	QS8081	P8170	51223
PGO-5251	PF2252G	P8445	CH8087	1213	PZ160	L25251	L25251	LC8445	51213
PGO-5274	PF2129	P2129	CH8765	7090	PZ55	L25274	QS8765	VO67	57090
PGO-5276	PF2247G	P8153	CH9301	1226	PZ60	L25536	QS8481	VO69	57038
PGO-5280	PF2249G	P8198	CH8213	1186	PZ149	L35280	L35280	VO74	51186
PGO-5288	PF61	PH59	PH3675	1522	PZ28	L25288	QS3675A	VO31	51522
PGO-5308	-----	P856	CH8530	7210	PZ64	L45308	QS8530	VO71	57210
PGO-5309	PF2227E	P2224	CH8806	7033	PZ56	L15309	QS8806	VO73	57033
PGO-5313	PF454	PH454	PH8873	7099	PZ52	L15313	QS8873	VO65	57099
PGO-5315	PF1682	P837	CH8712	7021	PZ62	L15315	QS8712	VO66	57021
PGO-5317	PF2254	PH2009	PH9010	1228	PZ57	L25522	QS5618	VO68	51228
PGO-5335	-----	LFP780	PH3976	7620	PZ47	L44422	QS45335	VO64	51607
PGO-5399	PF2232	LFP2999	PH9100	7202	PZ59	L35399	QS9100	VO75	57202
PGO-5436	PF457G	P3244	CH9018	7082	PZ58	L15436	QS9018	VO76	57082
PGO-5465	-----	P964	CH9584	7303	PZ157	L15465	L15465	VO82	57303
PGO-5476	PF2256G	P4456	CH9447	7079	PZ153	L35476	L35476	VO78	57079
PGO-5505	-----	P960	CH9641	7203	PZ159	L15505	QS15505	VO80	57203
PGO-5511	-----	P929	CH9955	7171	PZ158	L25511	-----	-----	57171
PGO-5514	-----	P963	CH9918	7009	-----	L45514	-----	-----	57009
PGO-5515	-----	LP2017	CH9549	7313	PZ170	L45526	QS45515	VO81	57311
PGO-5545	PF2193	P846	CH8158	1212	PZ61	L25545	QS8158	P846	51212
PGO-5581	-----	P3986	CH9911	7187	PZ162	L35581	QS45521	VO85	57187
PGO-5607	-----	P969	CH10075	7327	PZ163	L15607	-----	VO91	57327
PGO-5608	-----	P967	CH9972	7047	PZ161	L25608	QS45516	VO84	57047
PGO-5609	-----	P968	CH10158	7173	PZ165	L25609	-----	VO87	57173
PGO-5610	-----	P972	CH9999	7061	PZ164	L35610	-----	VO90	57061
PGO-5692	-----	P842	CH10415	7806	-----	L25692	-----	-----	57806
PGO-5702	-----	P979	CH10295	7310	PZ169	L25702	-----	-----	57041
PGO-5848	-----	P982	CH10515	7029	-----	L25848	-----	VO99	57250
PGO-6311	-----	P980	CH10358	7064	PZ172	L16311	QS45520	-----	57064
PGO-8113	-----	P3040	CH9461	7083	PZ154	L38113	L38113	VO77	57083
PGO-8812	PF2139	P834	CH5320	1160	PZ136	L28812	QS5320	LC834	51160

Pro Gauge Air Filters

Part #	A/C Delco	Champ	Fram	NAPA	Pennzoil	Purolator	Quaker State	Valvoline	WIX
PGA-4	A1103C	AF4	CA160	2020	PZA7	A40004	QSA160	VA7	42020
PGA-67	A178CW	AF178	CA192	2088	PZA19	A30067	QSA192	VA23	42088
PGA-74	A212CW	AF212	CA136	2095	PZA12	A60074	QSA136	VA4	42095
PGA-91	A348C	AF348	CA326	2098	PZA11	A50091	QSA326	VA2	42098
PGA-2534	A2040C	AF1688	CA8969	2524	PZA242	A25324	QSA8969	VA140	42524
PGA-3138	A735C	AF735	CA3537	2039	PZA21	A43138	QSA3537	VA31	42039
PGA-3192	A858C	AF602	CA3559	6120	PZA123	A13192	QSA3559	VA40	46120
PGA-3195	A1170C	AF773	CA3588	6040	PZA108	A43195	QSA3588	VA38	46040
PGA-3461	A1232C	AF7816	CA6690	6162	PZA177	A24645	QSA6690	VA96	46162
PGA-3465	A1089C	AF1031	CA3660	2133	PZA117	A23465	QSA3660	VA54	42133

Continued on Next Page

CONTINUED-Pro Gauge Air Filters

Part #	A/C Delco	Champ	Fram	NAPA	Pennzoil	Purolator	Quaker State	Valvoline	WIX
PGA-3472	A929C	AF971	CA3717	6132	PZA126	A33472	QSA3717	VA49	46132
PGA-3590	A1615C	AF974	CA3916	6503	PZA137	A33590	QSA3916	VA65	46503
PGA-3592	A1131C	AF1043	CA5058	6126	PZA138	A23592	QSA5058	VA66	46126
PGA-4278	A975C	AF293	CA4309	6116	PZA153	A24278	QSA4309	VA86	46116
PGA-4343	A1115C	AF1032A	CA5056	6134	PZA139	A24343	QSA5056	VA74	46134
PGA-4372	A1166C	AF7877	CA3901	6077	PZA150	A24372	QSA3901	VA76	46077
PGA-4378	A1146C	AF1046	CA6366	6174	PZA142	A24378	QSA6366	VA70	46174
PGA-4468	A1164C	AF351	CA6395	6244	PZA168	A24468	QSA6395	VA84	46244
PGA-4479	A1096C	AF1096	CA6479	6153	PZA162	A34479	QSA6479	VA78	46153
PGA-4601	A1229C	AF372	CA5125	6242	PZA161	A24601	QSA5125	AP372	46242
PGA-4645	A1232C	AF7816	CA6690	6162	PZA177	A24645	QSA6690	VA96	46162
PGA-4650	A1272C	AF7836	CA7094	6108	PZA175	A14650	QSA7094	VA101	46108
PGA-4669	A1256C	AF7825	CA6850	6027	PZA193	A54669	QSA6850	VA97	46027
PGA-4680	A1251C	AF7828	CA6807	6064	PZA172	A24680	QSA6807	VA83	46064
PGA-4688	-----	AF3974	CA9898	2612	PZA523	A44688	-----	VA207	42612
PGA-4690	A1286C	AF7841	CA7351	6017	PZA179	A24690	QSA7351	VA102	46017
PGA-4712	A1284C	AF7854	CA7365	6051	PZA180	A24712	QSA7365	AP7854	46428
PGA-4720	A1283C	AF7843	CA7344	6028	PZA197	A24720	QSA24720	VA104	46028
PGA-4721	A1329C	AF7864	CA7417	6006	PZA220	A34721	QSA7417	AF7864	46288
PGA-4722	A1347C	AF7892	CA5466	6273	PZA181	A24722	QSA5466	AP7892	46273
PGA-4727	A1267C	AF7845	CA7440	6213	PZA186	A44727	QSA7440	VA105	46213
PGA-4731	A1163C	AF7863	CA7421	6117	PZA189	A24731	QSA7421	VA108	46117
PGA-4799	A1287C	AF7842	CA7174	6026	PZA192	A34799	QSA7174	VA103	46026
PGA-4831	A1323C	AF7857	CA7628	6095	PZA202	A24831	QSA24831	AP7857	46095
PGA-4838	-----	AF7906	CA7620	6298	PZA423	A34838	QSA7620	A886	46799
PGA-4852	A917C	AF917	CA3914	6144	PZA196	A34852	QSA3914	AP917	46144
PGA-4873	A1289C	AF7880	CA7420	6303	PZA199	A24873	QSA7420	VA113	46303
PGA-4877	A1292C	AF7874	CA7730	6289	PZA187	A34877	QSA34877	VA89	46289
PGA-4878	A1517C	AF1615	CA8039	6418	PZA206	A34878	QSA34878	VA94	46418
PGA-4880	A1208C	AF7872	CA7597	6302	PZA26	A24880	QSA7597	VA109	46302
PGA-4881	A1233C	AF7873	CA7598	6301	PZA27	A24881	QSA7598	VA110	46301
PGA-4886	A1316C	AF7867	CA7626	6109	PZA216	A34840	QSA34886	VA125	46109
PGA-5043	A1291C	AF1618	CA7614	6390	PZA212	A25043	QSA7614	VA120	46390
PGA-5048	A1298C	AF7879	CA7432	6425	PZA200	A25048	QSA25048	VA112	46425
PGA-5049	A1549C	AF7893	CA5595	6105	PZA228	A25049	QSA5595	AP7893	46105
PGA-5089	A1548C	AF7910	CA8205	6081	PZA227	A25089	QSA8205	VA129	46081
PGA-5091	A1301C	AF1301	CA8037	6441	PZA204	A45091	QSA8037	-----	46441
PGA-5148	A1511C	AF7908	CA8040	6358	PZA214	A25148	QSA25148	AP7908	46358
PGA-5150	A1512C	AF7913	CA7764	6388	PZA219	A35150	QSA7764	VA135	46388
PGA-5155	A1547C	AF1643	CA8142	6406	PZA207	A35155	QSA35155	A1643	46406
PGA-5192	A1604C	AF1744	CA9563	6253	PZA477	A35192	QSA35192	AP1658	46253
PGA-5219	A1616C	AF7911	CA8069	6195	PZA270	A35219	QSA8069	VA144	46195
PGA-5227	A1279C	AF1279	CA8221	6035	PZA217	A35227	QSA8221	VA91	46035
PGA-5244	A2044C	AF7914	CA8208	6215	PZA407	A35244	QSA35244	VA153	46215
PGA-5248	A1611C	AF7919	CA8133	6443	PZA233	A25248	QSA8133	VA117	46443
PGA-5249	A1612C	AF7920	CA8475	6444	PZA235	A25249	QSA8475	VA118	46444
PGA-5258	A2848C	AF7944	CA8548	6462	PZA251	A35258	QSA8548	VA178	46462
PGA-5265	A1610C	AF7917	CA8606	6472	PZA236	A35265	QSA8606	VA116	46472
PGA-5266	A2056C	AF8248	CA8121	2015	PZA249	A35266	QSA8121	VA147	42015

Continued on Next Page

CONTINUED-Pro Gauge Air Filters

Part #	A/C Delco	Champ	Fram	NAPA	Pennzoil	Purolator	Quaker State	Valvoline	WIX
PGA-5265	A1610C	AF7917	CA8606	6472	PZA236	A35265	QSA8606	VA116	46472
PGA-5266	A2056C	AF8248	CA8121	2015	PZA249	A35266	QSA8121	VA147	42015
PGA-5267	A2046C	AF7935	CA8602	2472	PZA240	A35267	QSA8602	VA138	42472
PGA-5278	-----	AF5857	CA8613	6465	PZA414	A35278	-----	VA159	46465
PGA-5290	A1509C	AF7882	CA7774	6416	PZA188	A34879	QSA7774	VA114	46416
PGA-5301	A2038C	AF1679	CA8956	2341	PZA265	A25301	QSA8956	VA142	42341
PGA-5305	A2047C	AF7938	CA8918	2476	PZA250	A35305	QSA8918	VA146	42476
PGA-5306	A2048C	AF7946	CA8805	2384	PZA241	A25306	QSA8805	VA137	42384
PGA-5314	A1519C	AF1519	CA8756	2487	PZA237	A45314	QSA8755	VA115	42487
PGA-5323	A2039C	AF1696	CA8997	2793	PZA244	A35323	QSA8997	VA141	42793
PGA-5324	A2040C	AF1688	CA8969	2524	PZA242	A25324	QSA8969	VA140	42524
PGA-5330	A1096C	AF1096	CA8754	6153	PZA243	A35330	QSA8754	-----	46153
PGA-5353	A2053C	AF7965	CA9113	2728	PZA248	A25353	QSA9113	VA150	42728
PGA-5359	A2013C	AF7954	CA9286	2891	PZA258	A35359	QSA9286	VA151	42891
PGA-5363	-----	AF7964	CA9115	6646	PZA429	A15363	-----	VA191	46646
PGA-5370	A2050C	AF7953	CA8922	2825	PZA427	A35370	-----	AF7953	42825
PGA-5372	-----	AF7975	CA8747	6699	PZA264	A25372	QSA8747	VA156	46699
PGA-5373	A2052C	AF7959	CA8766	2797	PZA254	A25373	QSA8766	VA152	42797
PGA-5378	A1341C	AF7878	CA7640	6293	PZA203	A55378	QSA7640	VA111	46293
PGA-5387	-----	AF7982	CA9441	2740	PZA447	A45387	QSA45387	VA172	42740
PGA-5395	-----	AF7999	CA9392	2551	PZA439	A25395	QSA25395	VA193	42551
PGA-5396	A2055C	AF4048	CA10516	2389	PZA257	A35396	QSA9054	VA154	42389
PGA-5397	-----	AF7990	CA8911	2564	PZA259	A35397	QSA8911	VA165	42564
PGA-5398	-----	AF7991	CA9359	6322	PZA267	A25398	QSA9359	VA170	46322
PGA-5400	A1621C	AF7996	CA9269	6573	PZA255	A55400	QSA9269	VA169	46573
PGA-5403	-----	AF7998	CA9361	6802	PZA443	A35403	QSA35403	VA192	46802
PGA-5405	A2054C	AF7981	CA9053	6677	PZA262	A25405	QSA9053	VA155	46677
PGA-5414	-----	AF3588	CA8817	2329	PZA272	A35414	QSA8817	VA164	42329
PGA-5418	A2957C	AF1695	CA9332	2824	PZA268	A25418	QSA9332	VA162	42484
PGA-5431	A1627C	AF3594	CA9492	6902	PZA434	A35431	-----	VA176	46902
PGA-5432	A2933C	AF9010	CA9360	6673	PZA263	A35432	QSA9360	VA163	46673
PGA-5433	A2014C	AF2014	CA9345	2729	PZA269	A35433	QSA9345	VA161	42729
PGA-5434	-----	AF3589	CA9555	2086	PZA445	A35434	-----	VA185	42086
PGA-5446	-----	LAF9096	CA9400	6728	PZA260	A25446	QSA9400	VA167	46728
PGA-5456	-----	AF9098	CA9493	2188	PZA442	A25456	QSA25456	VA196	42188
PGA-5462	-----	AF3590	CA9401	2725	PZA271	A35462	QSA9401	VA160	42725
PGA-5463	-----	AF3595	CA9482	6834	PZA433	A25463	QSA25463	VA171	46834
PGA-5499	A2036C	AF7958	CA9481	6803	PZA432	A25499	QSA9481	-----	46803
PGA-5503	-----	AF3216	CA9564	6831	PZA450	A25503	QSA9564	VA183	46831
PGA-5507	-----	AF3245	CA9600	6832	PZA451	A25507	QSA9600	VA184	46832
PGA-5512	-----	LAF5980	CA9589	9062	PZA454	A45512	-----	VA177	42846
PGA-5513	-----	AF2340	CA9603	6887	PZA453	A35513	-----	VA175	46887
PGA-5517	A2953C	AF2441	CA9525	2164	PZA452	A35517	-----	-----	42164
PGA-5521	-----	AF5191	CA9662	6879	PZA457	A55521	-----	VA189	46879
PGA-5525	-----	AF3895	CA9669	2885	PZA460	A25525	-----	VA194	42885
PGA-5528	-----	AF1754	CA9687	6804	PZA462	A35528	-----	VA182	46804
PGA-5534	-----	AF3958	CA9681	6873	PZA459	A35534	-----	VA206	46873
PGA-5553	-----	AF3956	CA9762	2750	PZA468	A35553	-----	VA179	42750
PGA-5556	-----	AF1624	CA9778	2013	PZA469	A35556	-----	VA181	42013

Continued on Next Page

CONTINUED-Pro Gauge Air Filters

Part #	A/C Delco	Champ	Fram	NAPA	Pennzoil	Purolator	Quaker State	Valvoline	WIX
PGA-5560	A1624C	AF3904	CA9838	2843	PZA475	A35560	-----	VA180	42843
PGA-5566	-----	AF2771	CA9944	6924	PZA474	A25566	-----	VA197	46924
PGA-5568	-----	AF3598	CA9895	6975	PZA473	A45568	-----	VA186	46975
PGA-5578	-----	PZA480	CA9683	6888	PZA458	A35578	-----	VA195	46888
PGA-5583	-----	AF2786	CA10092	9053	PZA480	A35583	-----	VA216	49053
PGA-5603	-----	AF2962	CA10014	9115	PZA478	A35603	-----	VA200	49115
PGA-5635	A2962C	AF4012	CA10118	9192	PZA505	A25635	-----	-----	49192
PGA-5649	-----	AF4017	CA10171	9223	PZA518	A35649	-----	VA214	49223
PGA-5650	-----	AF3996	CA10169	9172	PZA485	A45650	-----	VA209	49172
PGA-5653	-----	AF4008	CA10165	9065	PZA507	A25653	-----	VA212	49065
PGA-5698	-----	AF3983	CA10159	9116	PZA510	A25698	-----	-----	49116
PGA-5707	-----	AF2956	CA9969	9117	PZA522	A35707	-----	VA203	49117
PGA-7039	A2956C	AF7884	CA8080	2295	PZA252	A47039	QSA7651	VA157	42295

Pro Gauge Cabin Air Filters



Part #	A/C Delco	Champ	Fram	NAPA	Pennzoil	Purolator	Quaker State	Valvoline	WIX
C15388	CF104	CAF1707	CF8791	4805	PC-31	C15388	C15388	E1AC2003	24805
C15389	CF107	CAF1743	CF8921	4807	PC-34	C15389	C15389	E1AC1008	24807
C15390	CF110C	CAF1708	CF8603	4752	PC-7	C15390	C15390	E1AC2006	24752
C15439	CF110	CAF1758	CF10135	4817	PC-40	C15439	C15439	E1AC1012	24817
C15471	CF119C	CAF7757	CF10136	4868	PC-41C	C15471	C15471	E1AC1021	24868
C25082	CF112	CAF1703	CF8109A	4773	PC-3	C25082	C25082	E1AC1001	24773
C25245	CF132	CAF1706	CF8392	4780	PC-1	C25245	C25245	E1AC2002	24780
C25246	CF115	CAF1704	CF8327A	4811	-----	C25246	C25246	E1AC2021	24811
C25478	CF108	CA1755	CF10137	4816	PC-38	C25478	C25478	E1AC2020	24816
C25490	CF109	CAF1762	CF10141	4872	PC-47	C25490	C25490	E1AC1030	24872
C25573	CF112	CAF1703	CF8109A	4773	PC-3	C25082	C25082	E1AC1001	24773
C35448	CF117	CAF1742	-----	4812	PC-35	C35448	C35448	E1AC2022	24812
C35479	-----	CAF1766	CF10132	4883	PC-48	C35479	C35479	E1AC1014	24883
C35491	-----	CAF1764	CF10133	4873	PC-44	C35491	C35491	E1AC2028	24873
C35494	-----	CAF7749	CF9597	4864	PC-49	C35494	C35494	E1AC1010	24864
C35516	-----	CAF1766	CF10383	4875	PC-60	C35516	C35516	-----	24875
C35519	-----	CAF1781	CF10134	4815	PC-58	C35519	C35519	-----	24815
C35530	-----	CAF1792	CF10140	9363	PC-78	C35530	C35530	-----	24857
C35643	-----	CAF1802P	CF10372	4907	PC-70	C35643	C35643	-----	24907
C35644	CF134	CAF1765	CF10374	4871	PC-45	C35644	C35644	-----	24871
C35661	-----	CAF1814	CF10381	4517	-----	C35661	C35661	-----	24517
C35667	-----	CAF1816P	-----	4483	-----	C35667	C35667	-----	24511
C35676	CF125	CAF1797	CF10361	4882	PC-79	C35676	C35676	-----	24882
C35677	-----	CAF1805C	CF10364	4909	PC-76	C35677	C35677	-----	24909
C38188	-----	CAF1751	CF10139	4900	PC-72	C38188	C38188	-----	24900
C38222	-----	CAF1774	CF10138	4901	PC-62	C38222	C38222	-----	24901
C45383	-----	CAF7702	CF8644	4322	PC-8	C45383	C45383	E1AC1026	24822
C45384	-----	CAF1713	CF8631	4876	PC-18	C45384	C45384	E1AC2017	24876
C45459	-----	CAF1770	CF8813	4897	PC-54	C45459	C45459	E1AC2013	24897
C45527	CF127	CAF1812	CF10360	4814	PC-75C	C45527	C45527	-----	24814

Tire Repair



Patches (For all Type of Tube and Tubeless Tire Repair)

All Rubber Feather Edged Patches (Regular-Chemical) with Blue Poly

Part #	Description	Tech	Kex	Camel
1P	Sm. Round Box 40- 1_5/8"	11	001	14-152
2P	Sm. Oval Box of 20 1_1/2"x 2_1/2"	17	004	14-157
3P	Med. Round Box of 30- 2_1/4"	12	002	14-153
4P	Med. Oval Box of 20 1_7/8"x 3_7/8"	18	005	14-159
5P	Lrg. Round Box of 20-3_1/8"	13	003	14-154

All Rubber Feather Edged Patches (Foilback-Pure Chemical)

Part #	Description	Rema	Kex	Camel	Truflex
051	Sm. Round Box of 50- 1_9/16"	1	051	14-351	TF1
052	Med. Round Box of 40- 1_13/16"	2	052	14-352	TF2
053	Lrg. Round Box of 30- 2_1/8"	3	053	14-353	TF3
054	Giant Round Box of 20- 3"	4	054	14-355	TF4



Radial Tire Patches

Part #	Description	Tech	Kex	Camel	Truflex
051	Sm. Round Box of 50- 1_9/16"	1	051	14-351	TF1
052	Med. Round Box of 40- 1_13/16"	2	052	14-352	TF2
053	Lrg. Round Box of 30- 2_1/8"	3	053	14-353	TF3
054	Giant Round Box of 20- 3"	4	054	14-355	TF4

Cris Cross Boots (90 degree)

Part #	Description	Tech	Camel	Truflex
9B	9" 4 Ply Box of 12	406	464	13-107
12B	12" 3 Ply Box of 12	444	465	13-108
3B	3_1/2" 2 Ply Box of 18	402	460	13-102
5B	5" 3 Ply Box of 12	441	461	13-103
6B	6" 3 Ply Box of 12	442	462	13-105

Patch and Plug Combo Patch & Stem Vulcanize

Part #	Description
381	1_3/4" Rd. Patch, 3/16" Stem for Pinhole Punctures, Shoulder, Tread, or Sidewall, Box of 20
382	2_1/2" Rd. Patch, 5/16" Stem for Nail-hole Punctures, Shoulder, Tread, or Sidewall, Box of 15

On the Wheel Repairs (Plugs)

String Plugs



Part #	Description	Camel	Kex
30	"Fat Cat" 4" Brown 100% Self Vulcanizing 30/Box	-	-
MS60	"Master Seal" 4" Brown 100% Self Vulcanizing 60/Box	15-280	361
MS60K	"Master Seal" Start-up Kit, Contains 60 MS 60 Repairs, Insert Tool, Replacement Needle, Reaming Tool, Razor, & Jar of Lube	-	-
229S	"Never Leak" 7" Black String Regular 50/Box	15-206	370
230S	"Never Leak" 7" Black Super Thick 50/Box	15-207	-

Rubber Inserts (Plugs)

Part #	Description	Camel	Kex
A-331	Kex Type Orange and Black 5 Ply Bowtie 50/Box	-	331
242	Straight Plug 2_3/8" x 1/4" 50/Box	15-179	-

Tubeless Tire Repair Kits – Carded

Part #	Description	Camel	Kex
TR-1	Contains 6 Inserts, Insert Tool, & Cement	15-169	803
TR-2	Contains 8 6" String Repair & Needle	15-165	-

Bike Patch Repair Kits

Part #	Description	Camel	Kex
53BK	Bike kits, Boxed 12/per chute	15-169	803

Camel Tire Repair

Part #	Description
14-137	Radial Patch, Small 2-1/4"
14-139	Radial Patch, Medium 3-1/8"
14-152	Chemical Patch, Round-Small
14-153	Chemical Patch, Round-Medium
15-280	String Repair- Brown – 4" Heavy Duty

Cements, Solutions, Chemicals, Misc.

Cement-Flammable

Part #	Description	Camel	Tech	Kex
540C	8 oz. All Purpose Cement, Brush Top Can	12-086	760	511
542C	32 oz. All Purpose Cement, Brush Top	12-089	-	512
546B	32 oz. Liquid Buffer, Squirt Top Can	-	-	704

Bead Sealer – Brush Top Can

Part #	Description	Camel	Tech	Kex
BS-1	Quart Size Bead Sealer Cement, Black	12-090	735	507

Rubber Lubricant – Master

Part #	Description	Tech
RL168	Gallon Jug, Tire Mounting Lubricant-Ready Mix	721
B-19	Bead Swab 6 per pack	-

Tools – Use with MS60 or #30

Part #	Description
223R	Steel “Heavy Duty” T Handle w/Rasp
223S	Steel “Heavy Duty” T Handle w/Replaceable Split Eye Needle
223P	Plastic T Handle w/Split Eye Needle
224RT	Replacement PROBE for 223R
224RS	Replacement Split Eye Needle for 223S



Tools – Use with 331, 241J, 241, 204B, 242

Part #	Description
247T	Heavy Duty Screwdriver Handle Needle (Open Eye)



Tools – Use with 229S, 230S

Part #	Description
231T	Closed Eye Screwdriver Handle



Other Tools

Part #	Description
UTT-4	Universal Tire Tool, 2 Split Eye Needles, 1 Probe/Rasp Needle, and Fold-Up Cutting tool; All 4 Pieces Fit in the Storage Compartment of the Heavy Duty Plastic T-Handle
261RT	Heavy Duty Reaming Tool
BB	Heavy Duty Patch Roller
BS	Metal Buffer Stitcher
BC-1	Replacement Buffer Cone 2-1/2"
17-253	Yellow Marking Crayon, Box of 12



**Grey Pneumatic Flip Impact Sockets
Extra Thin Wall 1/2" Drive**

Part #	Description
2146	DT 3/4" x 13/16"
2192	DT19mm x 21 mm

Emergency Lug Nut Remover

Part #	Description
A155 (M980)	Emergency Lugnut Remover 2/card

Trailer Tube – 8"

Part #	Description
400	480 x 8

Light Truck

Part #	Description	Valve
K/M-15L	700/750-15LT	TR-135
F-16L	550/600/650/F78-16LT	TR-15
K-16L	700/H78-16LT	TR-15
M-16L	700/750/L78-16LT	TR-135
MR-16L	700R/750R/L78R-16LT	TR-135

Truck

Part #	Valve
900-20	TR-175A
1000-20	TR-78A
1000R-20 (Radial)	TR-78A

Tire Tubes



Radial Passenger Tubes with TR-13 Valve Stem

Part #	Flat Tire Sizes
FR-13	145-155-165-175Rx13; A-BR78x13, A-BR70x13, AR60x13; P155-165-175/80Rx13, P165-185/70Rx13, P175/75Rx13, P195/65Rx13, P195-205/60Rx13
GR-14	175-185-195Rx14; C-D-ER78x14, C-D-ER70x14; P185-195/75Rx14, P195-205/70Rx14, P205/65Rx14, P215/60Rx14
GR-15	185-195Rx15; C-D-E-FR78x15, C-D-E-FR70x15; P185-195/75Rx15
KR-14	205-215-225Rx14; F-G-HR78x14, F-G-HR70x14, E-FR60x14; P205-215-225/75Rx14, P215-225/70Rx14
MR-14	195R/205R/215R/225R/235Rx14 HR78/LR78/HR70/LR70x14
KR-15	205-215Rx15; G-HR78x15, GR70x15, GR60x15; P195/80Rx15, P205-215/75Rx15, P215-225-235/70Rx15
MR-15	225-235Rx15; J-K-LR78x15, H-J-K-LR70x15; P225-235/75Rx15, P245-255/70Rx15

Bias Passenger Tubes with TR-13 Valve Stem

Part #	Flat Tire Sizes
G-14	C-D-E 78x14, C-D-E 70x14; P185-195/75x14, P195-205/70x14, P205/65x14, P215/60x14
K-14	F-G-H 78x14, F-G-H 70x14, E-F 60x14; P205-215-225/75x14, P215-225/70x14
G-15	C-D-E-F 78x15, C-D-E-F 70x15; P185-195/75x15
K-15	G-H 78x15, G-H 70x15, G 60x15; P195/80x15, P205-215/75x15, P215-225-235/70x15
M-15	J-K-L 78x15, J-K-L 70x15; P225-235/75x15, P245-255/70x15

TPMS



Part #	Description
17-20007	TPMS Assortment Kit contains: 600 Ea. EPDM Sensor Grommets, 400 Washers, 100 TPMS Valve Caps, 100 TPMS Valve Cores & 1 TPMS Valve Core Torque Tool & Application Guide
17-21300	TPMS Replacement Parts Kit contains: 124 Sensor Replacement Parts-Domestic and Imports, TPMS Valve Core Torque Tool, 100 TPMS Valve Caps & 100 TPMS Valve Cores

TPMS Tools

Part #	Description
17-161	1/4" Drive Torque Wrench 30-150 in lbs. w/case
17-173	Valve Core Torque Tool

TPMS Valve Cores & Caps

Part #	Description
17-490-T	TPMS Nickel Plated Valve Cores 100/Box
17-492-T	Gray Plastic Valve Caps w/seals 100/Box

TPMS Service Kits- Contains: Sensor Grommet, Washer, Valve Core, Nut and Valve Cap (Box of 10)

Part #	Description
17-20005AK	TPMS Service Kit-Nissan
17-20006AK	TPMS Service Kit-GM
17-20007AK	TPMS Service Kit-Nissan
17-20028AK	TPMS Service Kit- Chrysler
17-20035AK	TPMS Service Kit-Honda w/long Valve
17-20036AK	TPMS Service Kit-Honda w/short Valve
17-20096AK	TPMS Service Kit-Ford
17-20107AK	TPMS Service Kit-GM
17-20211AK	TPMS Service Kit-Mercedes, VW, Import
17-20216AK	TPMS Service Kit-Toyota & Lexus
17-20217AK	TPMS Service Kit-Toyota
17-20201AK	TPMS Service Kit-Chy., GM, Mazda, Imp
17-20202AK	TPMS Service Kit-VW
17-20203AK	TPMS Service Kit-Mercedes
17-20206AK	TPMS Service Kit-GM
17-20221AK	TPMS Service Kit-Lexus SC430(02-05)
17-20008AK	TPMS Service Kit-GM

Valve Stems with Cap & Core-Rubber Snap-In Valve

Part #	Length	Hole Size
TR413	1_1/4"	.453
TR414	1_1/2"	.453
TR415	1_1/4"	.625
TR418	2"	.453
TR423	2"	.453
TR425	2"	.625



High Pressure Valve Stems

Part #	Length	Hole Size
17-600 HP	1_3/4"	.453

Truck and Tractor Stems

Part #	Length	Hole Size
TR572	Truck Tubeless Stem 4"	.

Valve Hardware

Part #	Description
300S	Valve Cores, short
306	Plastic Caps
325	4-way Valve tool
S449	Stem Mounting tool (Milton)

Wheel Weights

We carry North American manufactured wheel weights.

We can set-up a bin service

that meets the needs of steel, alloy, or aluminum wheels.

We stock steel, zinc, and lead wheel weights. We supply coated and un-

coated wheel weights. Wheel weights are color coded and we can

supply all sizes of **BLACK,**

YELLOW, BLUE, ORANGE,

GREEN, GREY, PURPLE AND

RED coded wheel weights. We also

carry **STICK-ON** wheel weights.



Little Trees Air Freshener

Part #	Description
U1P-10100	Classic Assortment
U1P-10101	Royal Pine
U1P-10105	Vanillaroma
U1P-10189	New Car Scent
U1P-10155	Black Ice
U1P-10300	Fruit Assortment



Latex Gloves



Part #	Description
	GloveWorks Heavy Duty Latex Gloves

Razor Blades

Part #	Description
RB12	Razor Blades

Electrical Tape- U/L Approved
(10 Rolls/Sleeve)

Part #	Description
UL60	Tape, 10-60'x3/4" Rolls
UL30	Tape, 10-30'x3/4" Rolls

Grease



Part #	Description
GL14	Lithium Grease All Purpose Cartridge 14 oz.
GL16	Lithium Grease All Purpose Tub 16 oz.
GHT14	High Temp Wheel Brg Grease Cartridge 14 oz.
GHT16	High Temp Wheel Brg Grease Tub 16 oz.
GML14	Moly Grease Cartridge 14 oz.
GMR14	Marine Grease Cartridge 14 oz.
ECL-1	Electrical Contact Lube Dielectric Grease .33 oz.

Shop Towels-Scott Paper

Part #	Description
75130	Shop Towels on Roll, Blue, 55 Towels/Roll
75190	Shop Towels in Box, Blue, 200 Towels/Box



Hand Cleaner-GOJO

Part #	Description
1109	Original Go-Jo Crème, Plastic Can (14 oz.)
1115	Original Go-Jo Crème, Plastic Cart. (4.5 lbs.)
1135	Fine Italian Pumice, Plastic Cart. (4 lbs.)
1204	Cartridge Disp. For Part #'s 1115 & 1135
0955	Natural Orange Pumice w/pump (1 Gal.)
7272	Supro-Max
7200	Dispenser for #7272



J.B. Weld-Welding Compound

Part #	Description
8212C	J-B Mini-5 minute Clear Epoxy Syringe (12/cs)
8265S	Carded (6 Twin Tubes per box)
8265	J.B. Weld (6 Twin Tubes per box)
8267S	J.B. Stick 1-2oz. Tube per card (6 cds/Box)
8276	J.B. KWIK, Bonds in 4 minutes (6 Tubes per card, 6 cards/Box)
8277	WaterWeld 1 2oz. Tube/card 6 per case
8280	Industro Weld 2-5 oz. tubes per box (sold ea)
8201	Side Kick Display Contains 12 #8265S & 12 #8276



ANCO- Premium Wiper Blades

ANCO's wiper blades feature a vented bridge and metal flexor for original equipment fit and function. The blade features a DuraKlear rubber compound to provide a consistent, clean wipe. The patented rubber creates a razor-sharp wiping edge and features a natural, no-wax formula that offers protection from UV rays, ozone, air pollution, and road grime. Each blade also features the KwikConnect System.



Part Number	Description
31-13	13" wiper blade
31-14	14" wiper blade
31-15	15" wiper blade
31-16	16" Kwik-Connect Wiper Blade
31-17	17" Blade for Imports
31-18	18" Kwik-Connect Wiper Blade
31-19	19" Med. Profile Blade (BLK.)
31-20	20" Kwik-Connect Wiper Blade
31-21	21" Kwik-Connect Wiper Blade
31-22	22" Kwik-Connect Wiper Blade
31-24	24" Kwik-Connect Wiper Blade
31-26	26" Kwik-Connect Wiper Blade 5 In.
31-28	28" Kwik-Connect Wiper Blade

TVI Metal Wiper Blades

Metal Frame, Stainless Steel Backing, & Clear Plastic Display Pack



Part Number	Description
TVI 31-13	13" Wiper Blade
TVI 31-15	15" Wiper Blade
TVI 31-16	16" Wiper Blade
TVI 31-17	17" Wiper Blade
TVI 31-18	18" Wiper Blade
TVI 31-19	19" Wiper Blade
TVI 31-20A	20" Wiper Blade
TVI 31-21	21" Wiper Blade
TVI 31-22	22" Wiper Blade
TVI 31-24	24" Wiper Blade
TVI 31-26	26" Wiper Blade
TVI 31-28	28" Wiper Blade

HOSES- Pro-1 and Thermoid**Black Standard Heater Hose**

-40 Degrees F to +212 Degrees F



Pro 1 #	Thermoid #	Description
001725	000700001725	1/2" 50' Black Heater Hose
001726	00700001726	5/8" 50' Black Heater Hose
001727	00700001727	3/4" 50' Black Heater Hose

250' REEL

Pro 1 #	Thermoid #	Description
726250	00701726250	5/8" 250' Black Heater Hose
727250	00701727250	3/4" 250' Black Heater Hose

Black OEM Heater Hose

-40 Degrees F to +257 Degrees F

Pro 1 #	Thermoid #	Description
001825	00700001825	1/2" 50' BlackOEM H. H.
001826	00700001826	5/8" 50' BlackOEM H. H.
001827	00700001827	3/4" 50' BlackOEM H. H.

Red Standard Heater Hose

-40 Degrees F to +212 Degrees F

Pro 1 #	Thermoid #	Description
001735	000700001735	1/2" 50' Red Heater Hose
001736	00700001736	5/8" 50' Red Heater Hose
001737	00700001737	3/4" 50' Red Heater Hose

Red Premium Heater Hose

-40 Degrees F to +257 Degrees F

Pro 1 #	Thermoid #	Description
001835	00700001835	1/2" 50' Red Premium
001836	00700001836	5/8" 50' Red Premium
001837	00700001837	3/4" Red Premium

Red Standard Thermal Heavy Duty Heater Hose

-40 Degrees F to +212 Degrees F, 4 Spiral Polyester

Pro 1 #	Thermoid #	Description
004908	00700004908	5/8" 50' Red Std. Thermal HD
004910	00700004910	3/4" 50' Red Std. Thermal HD
004916	00700004916	1/2" 50' Red Std. Thermal HD

Red Premium Thermal Heavy Duty Heater Hose

-40 Degrees F to +257 Degrees F

Pro 1 #	Thermoid #	Description
005908	00700005908	5/8" 50' Red Prem. Thermal HD
005910	00700005910	3/4" 50' Red Prem. Thermal HD
005916	00700005916	1/2" 50' Red Prem. Thermal HD

Power Steering Return Hose

+250 Degrees, SAE J189

Pro 1 #	Thermoid #	Description
003820	00700003820	3/8" 25' Power Steering

Fuel Injection Hose

-29 Degrees F to +275 Degrees F, SAE30R9

Pro 1 #	Thermoid #	Description
000502	00700000502	1/4" 10' Fuel Inj. Hose (FI-502)
000503	00700000503	5/16" 10' Fuel Inj. Hose (FI-503)
000504	00700000504	3/8" 10' Fuel Inj. Hose (FI-504)

Air Hoses

Part Number	Description
G	Yellow Coiled Hose 1/4" 25 ft.
H	Yellow Coiled Hose 1/4" 50 ft.

**Emission – PCV – Hose – 25 FEET**

Part Number	Description
EM1132	11/32"

Emission Control Duct

Preheater Hoses – OEM Replacement – 12 per case

Part Number	Description
118S	Hose 1-1/2"X18" Insulated (Silver)
175S	Hose 1-3/4"X18" Insulated (Silver)
218S	Hose 2"X18" Insulated (Silver)

Service Station Air Hose

-40 Degrees F to +212 Degrees F



Pro 1 #	Thermoid #	Description
052225	00700052225	1/4" 25' Red Air Hose, Coupled
052250	00700052250	1/4" 50' Red Air Hose, Coupled
053825	00700053825	3/8" 25' Red Air Hose, Coupled
053850	00700053850	3/8" 50' Red Air Hose, Coupled

Regular Fuel Line Hose

-40 Degrees F to +212 Degrees, SAE30R6



Pro 1 #	Thermoid #	Description
024048	00700024048	3/16" 25' Fuel Line Hose
024060	00700024060	1/4" 25' Fuel Line Hose
024078	00700024078	5/16" 25' Fuel Line Hose
024088	00700024106	3/8" 25' Fuel Line Hose
024106	00700024106	7/16 25' Fuel Line Hose

250' Spool

Pro 1 #	Thermoid #	Description
024068	00700024068	1/4" 250' Fuel Line Hose
024084	00700024084	5/16" 250' Fuel Line Hose
024100	00700024100	3/8" 250' Fuel Line Hose

Premium Fuel Line Hose

-40 Degrees F to +257 Degrees, SAE30R7

Pro 1 #	Thermoid #	Description
025048	00700025048	3/16" 25' Prem. Fuel Line
025060	00700025060	1/4" 25' Prem. Fuel Line
025078	00700025078	5/16" 25' Prem. Fuel Line
025088	00700025088	3/8" 25' Prem. Fuel Line

Air Brake Hose

-40 Degrees F to +200 Degrees, SAEJ1402/FMVSS 106

Pro 1 #	Thermoid #	Description
026250	00700026250	3/8" 25' Air Brake Hose

Transmission Oil Cooler Hose

-30 Degrees F to +257 Degrees, SAE J1532

Pro 1 #	Thermoid #	Description
031616	00700031616	3/8" 25' Trans. Cooler Hose
032998	00700032998	5/16" 25' Trans. Cooler Hose

Driveway Signal Call Tubing

-40 Degrees F to +250 Degrees F

Pro 1 #	Thermoid #	Description
052050	00700052050	3/8" 50' Signal Call Tubing
520100	00700520100	3/8" 100' Signal Call Tubing

Crankcase Ventilation Hose

SAE 30R7

Pro 1 #	Thermoid #	Description
113225	00700113225	11/32" 25' Crankcase Vent

Windshield Wiper and Vacuum Tubing

-40 Degrees F to +250 Degrees F,SAE J1037

Pro 1 #	Thermoid #	Description
333950	00700333950	7/64" 50' WW/VAC
334050	00700334050	5/32" 50' WW/VAC
334150	00700334150	7/32" 50' WW/VAC
334250	00700334250	9/32" 50' WW/VAC

Nylon Fuel Line 25'

Part #	Description
2962-25	5/16"-8mm Nylon Fuel Line
2963-25	10mm Nylon Fuel Line
2997-25	1/4" Nylon Fuel Line
2998-25	3/8" Nylon Fuel Line

Fuel Line Repair Kit**Repair Steel & Nylon Fuel Lines**

Kit contains Heavy Duty Metal Press (Competitors Use Plastic) Plus Adapters, Quick Connectors & Fittings – Includes 15' of 5/16" & 10mm Nylon Fuel Hose – 3 Times Faster Connections than Competition – Most Repairs can be done on Vehicle

Part Number	Description
0454	Fuel Line Repair & Replace Assortment

Hose Connectors for Heater Hoses

(Sold 5 per bag)

Part Number	Description
HC28263	5/8" Straight Connector
HC28264	3/4" Straight Connector
HC28266	5/8" X 3/4" Straight Connector

All Purpose Vinyl Tubing

Extra Heavy Wall – 50 Feet Per Box



Part Number	Description
FL-110C	1/4" ID ___ Clear Vinyl Hose
FL-111C	5/16" ID ___ Clear Vinyl Hose
FL-112C	3/8" ID ___ Clear Vinyl Hose

Water Hoses – Heavy Duty – 5/8" DIA.

Part Number	Description
27111	HD Reinforced Rubber Hose 25 ft.

Swan Water Hoses

Part Number	Description
SNFA58025	Fairlawn-Knit Reinforced Brass Coupling 5/8" X 25'
SNFA58050	Fairlawn-Knit Reinforced Brass Coupling 5/8" X 50'
SNWF58050	Weatherflex-Knit Reinforced Brass Coupling Abrasion Resistant-Protective Collar 5/8" X 50'

Water Nozzles & Accessories

Part Number	Description
2280	Insulated Industrial Pistol Nozzle
2286	Heavy Duty Industrial Front Trigger Insulated Nozzle
2515	Fireman's Nozzle-Carran
3351	Brass/Nylon Male Hose Repair 5/8" & 3/4"
3352	Brass/Nylon Female Hose Repair 5/8" & 3/4"

HOSE CLAMPS- AMGAUGE

9/16 Band – Hex Head Screw,
Stainless Steel (10 Clamps per Box)



Part Number	Description
M4H	Mini 7/32 to 5/8
M6H	Mini 5/16 to 7/8
B6H	3/8 to 7/8
B10H	1/2 to 1_1/16
B12H	1/2 to 1_1/4
B16H	3/4 to 1_1/2
B20H	3/4 to 1_3/4
B24H	1 to 2
B28H	1_5/16 to 2_1/4
B32H	1_9/16 to 2_1/2
B36H	7/8 to 2_3/4
B40H	1_1/8 to 3
B44H	2_1/3 to 3_1/4
B48H	2_9/16 to 3_1/2
B52H	2_13/16 to 3_3/4
B56H	3_1/16 to 4
B64H	3_9/16 to 4_1/2
B72H	4_1/16 to 5
B104H	5 to 7

Hose Clamps – 1/2 BandHex Head Screw, Stainless Steel
(10 clamps per box)

Part Number	Description
SC4	Mini, 5/16 to 5/8
SC6	Mini, 3/8 to 7/8
CC6	3/8 to 7/8
CC8	7/16 to 1
CC10	1/2 to 1_1/8
CC12	1/2 to 1_1/4
CC16	3/4 to 1_1/2
CC20	3/4 to 1_3/4
CC24	1 to 2
CC28	1_5/16 to 2_1/4
CC32	1_9/16 to 2_1/2
CC36	7/8 to 2_3/4

Fuel Injection Clamps6MM Hex Head Screw – 9MM
Band (10 clamps per box)

Part Number	Description
F14 (52F13)	7/16 to 1/2
F16 (52F15)	1/2 to 9/16
F18 (52F16)	9/16 to 5/8

**Muffler Clamps – Standard
5/16" U-Bolts
H. D. 13 GA. Saddle**

Size	Nickson #	Part #
1_3/4"	00034	R134
1_7/8"	00035	R178
2"	00036	R200
2_1/8"	00037	R218
2_1/2"	00039	R212

**Muffler Clamps – Heavy Duty
3/8" U-Bolts, H.D. 11GA. Saddle**

Size	Nickson #	Part #
1_3/4" HD	00021	H134
1_7/8" HD	00022	H178
2" HD	00023	H200
2_1/4" HD	00024	H214
2_1/2" HD	00025	H212
2_3/4" HD	00060	HD275
3" HD	00061	HD300
3_1/2" HD	00063	HD312
4" HD	00065	HD400
5" HD	00068	HD500

Muffler Hangers and Straps

Nickson #	Part #	Description
00075	SWL3	"Swivler" Hanger H.D. 360 Design
17144	THU100	Universal Hanger
00150	THU403	Universal Strap Hanger

Exhaust Flange Replacement – Split Flange

Size	Walker #	Maremont #	Part #
2_1/4" to 2_1/2"	31871	F35	SF-1
1_3/4" to 2"	31884	F45	SF-2

HYDRAULIC BRAKE LINES

WILL NOT KINK • INDIVIDUALLY TAGGED • STEEL



Part #	Size	Part #	Size
BL308	3/16"X 8"	BL508	5/16"X 8"
BL312	3/16"X 12"	BL512	5/16"X 12"
BL320	3/16"X 20"	BL520	5/16"X 20"
BL330	3/16"X 30"	BL530	5/16"X 30"
BL340	3/16"X 40"	BL540	5/16"X 40"
BL351	3/16"X 51"	BL551	5/16"X 51"
BL360	3/16"X 60"	BL560	5/16"X 60"
BL408	1/4"X 8"	BL608	3/8"X 8"
BL412	1/4"X 12"	BL612	3/8"X 12"
BL420	1/4"X 20"	BL620	3/8"X 20"
BL430	1/4"X 30"	BL630	3/8"X 30"
BL440	1/4"X 40"	BL640	3/8"X 40"
BL451	1/4"X 51"	BL651	3/8"X 51"
BL460	1/4"X 60"	BL660	3/8"X 60"

BLJ SERIES – JAPANESE APPLICATIONS – METRIC THREAD – INVERTED STD. FLARE

Part #	Size	Part #	Size
BLJ308	3/16"X 8"	BLJ340	3/16"X 40"
BLJ312	3/16"X 12"	BLJ351	3/16"X 51"
BLJ320	3/16"X 20"	BLJ360	3/16"X 60"
BLJ330	3/16"X 30"		

BLJC SERIES – JAPANESE APPLICATIONS – METRIC THREAD – INVERTED STD. FLARE PVF GREEN COATED – CORROSION RESISTANT

Part #	Size	Part #	Size
BLJ308C	3/16"X 8"	BLJ340C	3/16"X 40"
BLJ312C	3/16"X 12"	BLJ351C	3/16"X 51"
BLJ320C	3/16"X 20"	BLJ360C	3/16"X 60"
BLJ330C	3/16"X 30"		

BLE SERIES – EUROPEAN/DOMESTIC APPLICATIONS – METRIC THREAD BUBBLE FLARE

Part #	Size	Part #	Size
BLE308	3/16"X 8"	BLE340	3/16"X 40"
BLE312	3/16"X 12"	BLE351	3/16"X 51"
BLE320	3/16"X 20"	BLE360	3/16"X 60"
BLE330	3/16"X 30"	BLE720	3/16"X 72"

BLE SERIES – EUROPEAN/DOMESTIC APPLICATIONS – METRIC THREAD BUBBLE FLARE

Part #	Size	Part #	Size
BLE308C	3/16"X 8"	BLE340C	3/16"X 40"
BLE312C	3/16"X 12"	BLE351C	3/16"X 51"
BLE320C	3/16"X 20"	BLE360C	3/16"X 60"
BLE330C	3/16"X 30"		



BRAKE TUBING PVF COATED TUBING

Part #	Size
PV73	3/16"X 25'
PV4	1/4"X 25'
PV5	5/16"X 25'
PV6	3/8"X 25'

25' STEEL BRAKE TUBING

Part #	Size
C3	3/16"X 25'
C4	1/4"X 25'
C5	5/16"X 25'
C6	3/8"X 25'
C7	6mm X 25'

BRAKE FITTINGS



Part #	Description
3000	3/16" Standard Tube Nut
3001	3/16" Tube Nut – Long
3002	3/16" Standard Flare Union
3003	1/4" Standard Tube Nut
3004	1/4" Tube Nut – Long
3005	1/4" Standard Flare Union
3006	5/16" Standard Tube Nut
3007	5/16" Standard Flare Union
3008	3/8" Tube Nut 16mm Thread
3009	5/16" Tube Nut 14mm Thread
3015	3/8" Tube Nut
3018	3/8" Brass Inverted Flare Union
3022	Red Tube Nut 3/16" - 7/16" Thread
3023	Green Tube Nut 3/16" - 1/2" Thread
3024	Olive Tube Nut 3/16" - 9/16" Thread
3025	Blue Tube Nut 1/4" - 9/16" Thread
3026	Grey Tube Nut 1/4" - 1/2" Thread
3028	Olive Metric Bubble 10mm
3039	Brass Adaptor 3/16" - 10mm Bubble
3040	Orange Metric 11mm – 1.50
3041	Blue Metric 12mm – 1.00
3042	Green Metric 13mm – 1.5
3043	Blue Metric Tube Nut 10mm
3044	10mm Bubble Union
3045	Brass Adaptor 3/16" - 10mm Japanese
3047	3/16" Brass Bubble Flare Union – British
3059	10mm Union
3410	3/16" Bubble Flare Tube Nut – 3/8"X 24 TPI British
3413	1/4" Bubble Flare Tube Nut – 12mmX 1.0 – Olive
3414	3/16" Bubble Flare Tube Nut – 10mmX 1.0 – Violet
3417	Blue Metric Long 10mm- 1.00
3420	3/16" Bubble Flare Tube Nut – 10mmX1.0 – Gold
3424	3/16" Steel Tube Nut – Violet
3426	3/16" Bubble Flare Tube Nut – 12mmX1.25 – Olive
3433	1/4" Bubble Flare Tube Nut – 12mmX1.25 – Gold

Blade Fuses-Buss

The industry standard-used in most domestic and imported cars today. All Buss blade fuses meet or exceed OEM and SAE standards. Buss is a certified OEM supplier of ATC, ATM, and MAXI fuses to car manufacturers.

TRADITIONAL TRAY (100/BOX)

Part Number	Description
ATC 3	
ATC 4	
ATC 5	
ATC 7 1/2	
ATC 10	
ATC 15	
ATC 20	
ATC 25	
ATC 30	
ATC 40	
90Asst	(90 Per Box)
ATM-5	Mini-Fuse
ATM-7 1/2	Mini-Fuse
ATM-10	Mini-Fuse
ATM-15	Mini-Fuse
ATM-20	Mini-Fuse
ATM-25	Mini-Fuse
ATM-30	Mini-Fuse
MAX-20	Maxi-Fuse (20 In)
MAX-25	Maxi-Fuse (20 In)
MAX-30	Maxi-Fuse (20 In)
MAX-35	Maxi-Fuse (20 In)
MAX-40	Maxi-Fuse (20 In)
MAX-50	Maxi-Fuse (20 In)
MAX-60	Maxi-Fuse (20 In)
FMX-20	Female Maxi-Fuse (10 In)
FMX-30	Female Maxi-Fuse (10 In)
FMX-40	Female Maxi-Fuse (10 In)
FMX-50	Female Maxi-Fuse (10 In)
FMX-60	Female Maxi-Fuse (10 In)



Fuses-Buss-Traditional

Used in older-model cars, glass tube fuses today are found primarily in automotive accessory applications.

METAL TRAY (50/BOX)



Part Number	Description	Part Number	Description
AGC 1		AGC 25	
AGC 2		AGC 30	
AGC 3		AGC 35	
AGC 5		SFE 14	
AGC 7 1/2		SFE 20	
AGC 10		SFE 30	
AGC 15		100 Popular ASST	
AGC 20			

Fusible Links-Buss

Used primarily in Japanese-designed car models to provide wiring harness protection



Part Number	Description
FLB-40	40 Amp Bolt-on 13/16" Terminal Green
FLB-60	60 Amp Bolt-on 13/16" Terminal Yellow
FLB-70	70 Amp Bolt-on 13/16" Terminal Brown
FLB-80	80 Amp Bolt-on 9/16" Terminal Black
FLF-20	20 Amp Female Termination Light Blue
FLF-30	30 Amp Female Termination Pink
FLF-40	40 Amp Female Termination Red
FLF-50	50 Amp Female Termination Yellow
FLF-60	60 Amp Female Termination Black
FLM-80	80 Amp Male Termination Black
FLM-100	100 Amp Male Termination Blue
FLS-30	30 Amp Female Mini-Termination Pink
FLS-40	40 Amp Female Mini-Termination Green



Fuse Display & Accessories

Part	Description
R45	Fusible Link Assortment, PAL Fuses, 16 Links: FLB 30 to 80; FLB100;FLF20 to 60; FLM 30, 60, 80, 100
R150	MINI-Fuse Display with 100 Mini-Blade Fuses, 10 Most Popular Sizes, ATM-2 to ATM-30
R200	Redi-Fuse Display, With 172 Assorted Glass, Blade, Mini, and Maxi Fuses
R245	MAXI-Fuse Display with 12 Maxi-Blade Fuses, 5 Most Popular Sizes, MAX-20 to MAX-60

Buss Fuse Holders & Assortments

Part Number	Description
No.16	Universal Fuse Holder 14 ga. Adapts to different length fuses 12/cd
No.18	H.D. Glass Fuse Holder for AFC Fuses to 30 Amp (and SFE 20) 12 ga. 12/cd
HHD-12	ATC Fuse Holder 12 ga. 30 Amp Rating 12/cd
AK-6 RLD	Fuse Assortment, 6 Blade Fuses (5 to 30 Amp) Per Tray, 5 Trays/Box

Smart Fuses — Carded Glows if Fuse is Blown

Part Number	Description
10-1008	5 pc. Assorted ATC Type Contains 1 Ea: 10-15-20-25 & 30 Amp Fuses
11-1008	5 pc. Assorted ATC Type Contains 1 Ea: 10-15-20-25 & 30 Amp Fuses

Flashers

Part Number	Description
TF552/536	Flasher

Heavy Duty Electronic Flashers

Part Number	Description
EF 32(EL 12)	2 Prong 12 Volt
EF 33 (EL 13)	3 Prong 12 Volt
EP 34	3 Prong 12 Volt (Ideal #768 & Wagner 7058)

Lighting

All of our lighting products are made by the industry's top manufacturers including Wagner, Sylvania, Philips, and GE.

Sealed Beam Halogens

All sealed-beam headlamps are built with application-specific, customized glass lenses that are the strongest, most cosmetically correct in the industry. The lamps include a non-reflective bottom shelf that increase amp effectiveness in rain, snow, and fog; and a rust-inhibiting coat of lacquer on ferrules to eliminate corrosion.

Part Number	Part Number
TBH 4651	TBH 5006
TBH 4656	TBH 6024
TBH 4701	TBH 6054
TBH 4703	TBH 6545
TBH 5001	



Late Model- Low Profile Halogens

Part Number	Part Number
	TBH 4351

Miniature Halogen Lamps

Carded , 1 Per Card

Manufactured with a continuous coil that resists shock and vibration, extending service life. Built to original equipment specifications.



Part Number	Description
BP 880	Back-up, Cornering
BP 881	Back-up, Cornering
BP 885	Back-Up
BP 886	Mini Halogen Bulb
BP 889	Back-up, High Mount Stop, Park
BP 891	High Mount Stop
BP 893	Fog & Autom. Halogen
BP 899	Mini Halogen Bulb

CAPSULE BULBS

Halogen Headlamp Bulbs

Part Number	Description
9003	Hi-Lo Halogen Headlamp Replacement
9004	Hi-Lo Halogen Headlamp Replacement
9005	Hi Halogen Headlamp Replacement
9006	Lo Halogen Headlamp Replacement
9007	Hi-Lo Halogen
9008	(H-13) Halogen



Miniature Bulbs

Carded-2 Per Card

Part Number	Part Number
922BP	7443BP
2040BP	7506BP
2825BP	7528BP
3496BP	3757ALLBP
3497BP	4114LLBP
5007BP	4157LLBP
5008BP	3157NALL/ 4157NALLBP
7225BP	161BP
7440BP	2721BP

10 Bulbs Per Box

Part Number	Description	Part Number	Description
24	Marker, License	1157	Stop & Turn
37	Automotive	1157A	Front Turn
53	Indicator	1816	Instrument
57	Instrument	1891	Courtesy
67	Parking	1893	Instrument
74	Indicator, Radio	1895	Instrument
89	Dome	2057	Stop & Turn, Late Model
97	Dome	2357	Stop & Turn
194	Instrument	2357A	Turn & Parking
194A	Parking	3057	2457
198	Stop & Turn	3057A	2457NA
211-2	Dome	3156	Corner, Back-up
212-2	Dome-Courtesy	3157	2458
561	Dome	3157A	2458NA
906	Courtesy	3357/3457	Stop & Turn
912	3rd Light Bulb	3357A	Stop & Turn
916A	Side Marker	4157LLTP	Stop Light
921	3rd Light Bulb	7440TP	Turn Signal
1003	Dome	7443TP	Turn Signal
1073	Front Turn	DE3175	Dome 12854 or 12100
1141	Rear Turn		
1156	Front Turn		

Service Bulbs

Rough Service Bulbs

Part Number	Description
50/AS	50 watt (24 bulbs per case)
75/AS	75 watt (24 bulbs per case)
100/AS	100 watt (24 bulbs per case)

Rough Service Bulbs

5000 Hour

Part Number	Description
100A/RS	100 watt (30 bulbs per case)
75A/RS	75 watt (30 bulbs per case)
50-12	12 volt, 50 watt (6/slv)

Tuff-Skin Rough Service Bulbs

Shatter Proof-OSHA Approved-5000 Hour-Brass Base

Part Number	Description
RS(50W)	50 watt (30 bulbs per case)
RS(75W)	75 watt (30 bulbs per case)
RS(100W)	100 Watt (30 bulbs per case)

Batteries & Flashlights



Part Number	Description
813-2	"D" Cell Maximum Alkaline (2 Pk) (12 packs per case)
814-2	"C" Cell Maximum Alkaline (2 Pk) (12 packs per case)
815-2	"AA" Cell Maximum Alkaline (2 Pk) (12 packs per case)
815-6	"AA" Cell Maximum Alkaline (6 Pk) (12 packs per case)
824-2	"AAA" Cell Maximum Alkaline (2Pk) (12 packs per case)
A1604-1	9 V Maximum Alkaline (1CD) (12 packs per case)
I2D-B	Industrial Flashlight Krypton Bulb w/2 D Cell Batteries
E2DB	Value Flashlight w/2 D Cell Batteries

QUICK INDEX

Tapping Screws

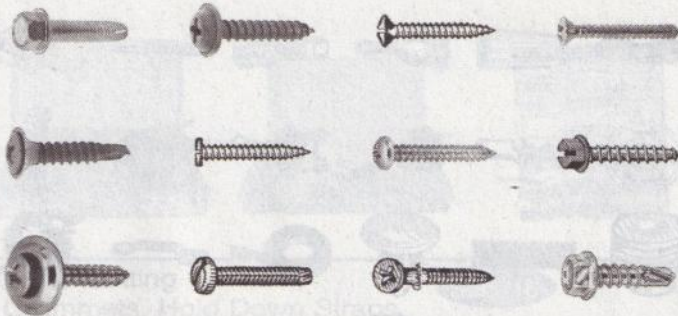

License Plate Fasteners

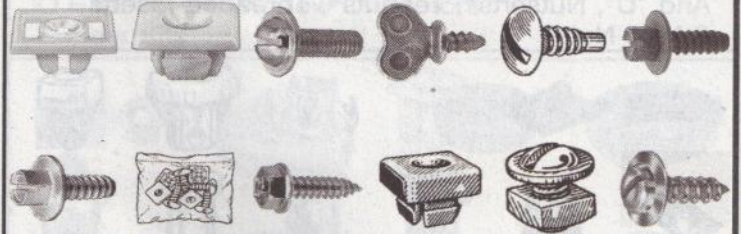

Cap Screws, Carriage Bolts, Frame Bolts, Machine Screws, Set Screws, Stainless Steel Fasteners & Stove Bolts

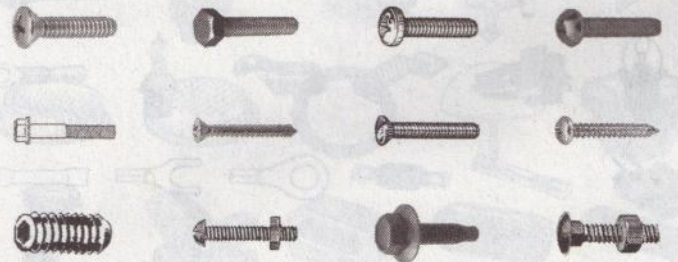

Cylinder Head And Manifold Studs & Threaded Rod



Metric Items

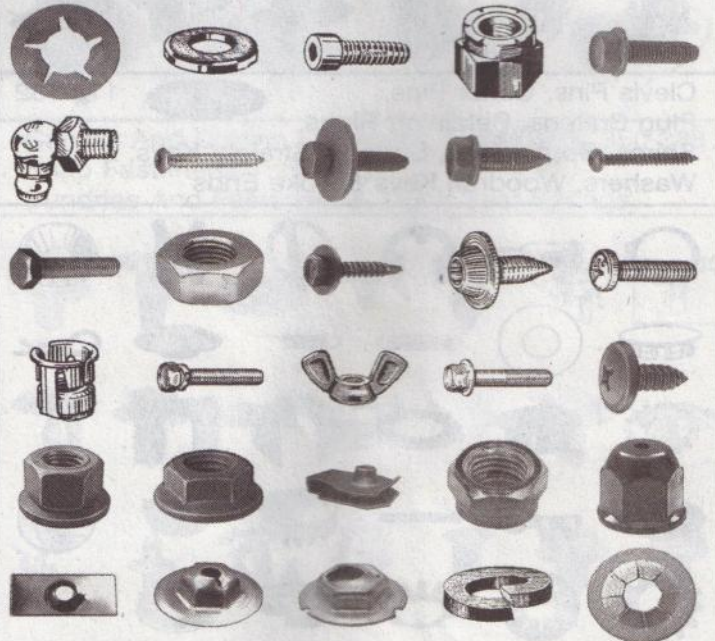

Body Bolts, Bumper Bolts & Special Carriage Bolts

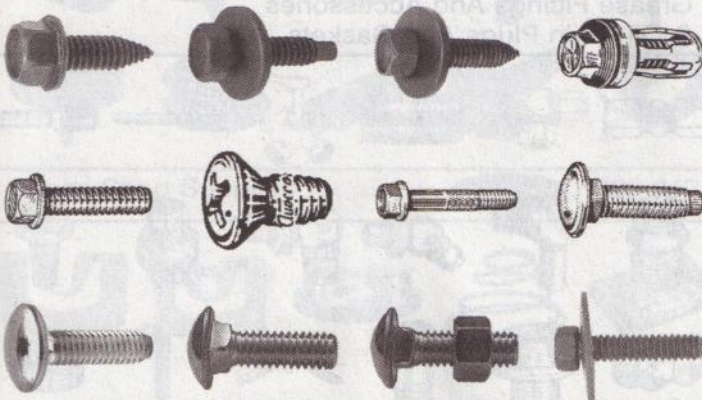

Nuts: Standards And Specials & Wheel Studs And Nuts



Special Tapping Screws

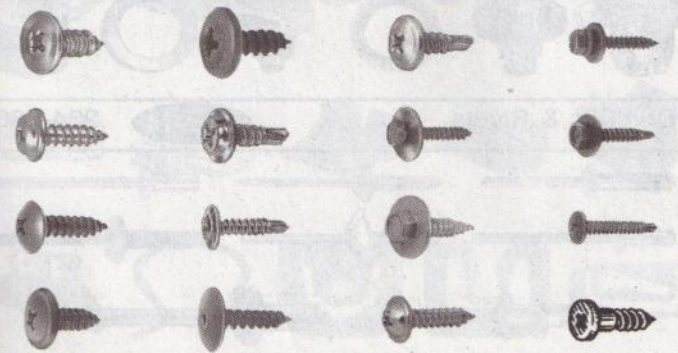

QUICK INDEX

Heli-Coils,
Nuts: Extruded "U", Flat, "J", Tubular
And "U", Nutserts®, Teenuts®, Threaded Inserts
& Well Nuts®



Clevis Pins, Cotter Pins,
Plug Buttons, Retaining Rings,
Shims, Spring Pins, Springs, Straight Keys,
Washers, Woodruff Keys & Yoke Ends



Connectors, Air Line Couplings,
Hose & Tubing

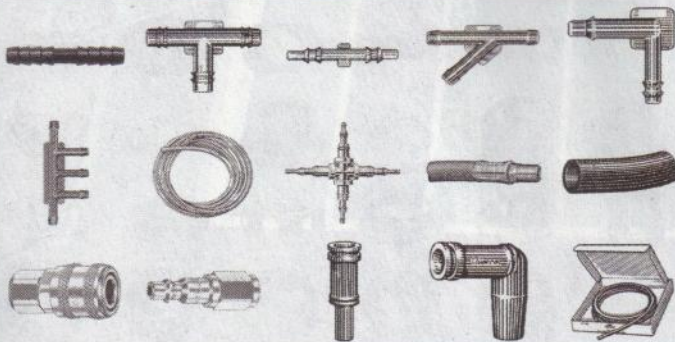

Cable Ties, Electrical Accessories
& Wire Loom Clips



Brass Fittings,
Grease Fittings And Accessories
& Oil Drain Plugs And Gaskets

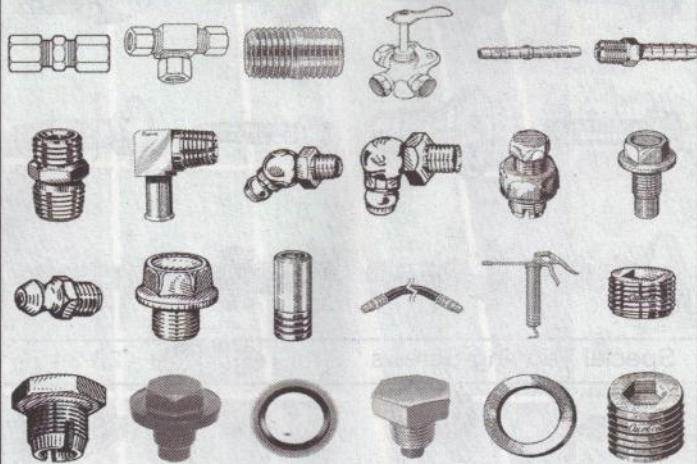

Drill Bits & Rivets

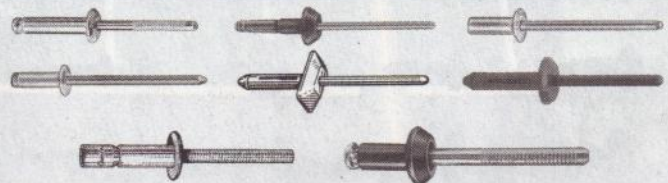

QUICK INDEX

Assortments, AuvecoPaks,
Cabinets, Drawers & Special Racks

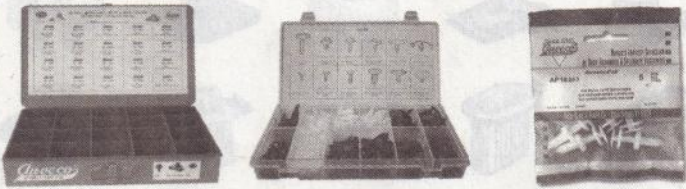

Glass Setting Channel,
Grommets, Hold Down Straps,
"O" Rings, Rubber Bumpers & Caps, Tire
Valves, Weatherstrip & Windshield Filler
Strip

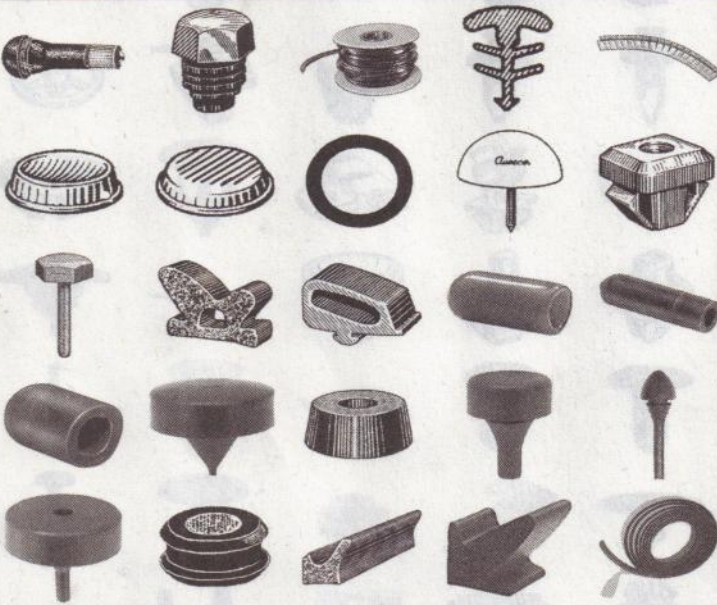

Glass Shop Supplies

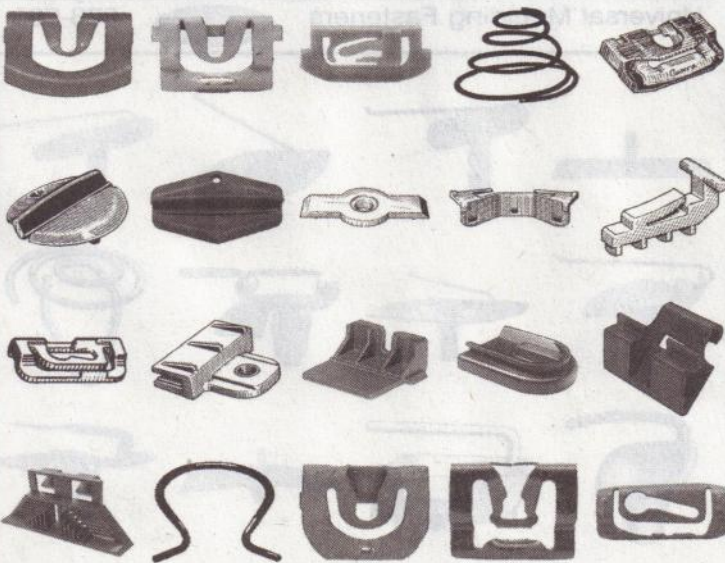

Horns, O.E.M. Air Conditioning,
Heater Fan And Radiator Fan Motors,
O.E.M. Power Window Lift Motors
& Gear Kits

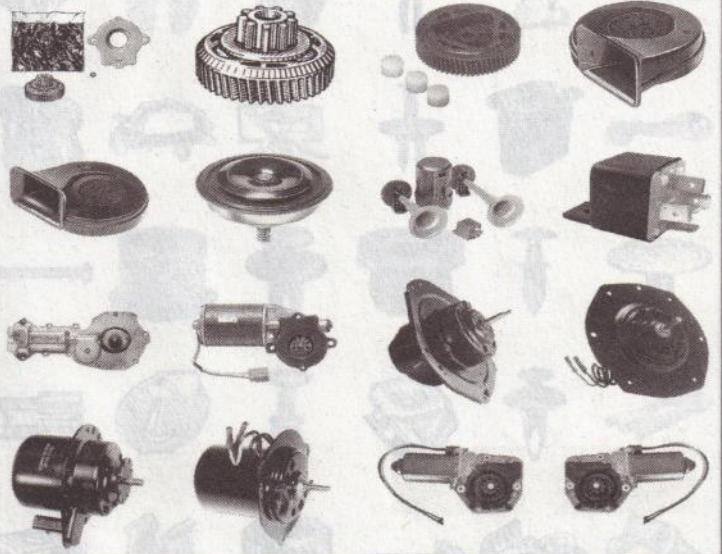

Canvas And Curtain Fasteners,
Snap Fasteners, Trimming
Sundries And Fasteners & Truck Seat Springs

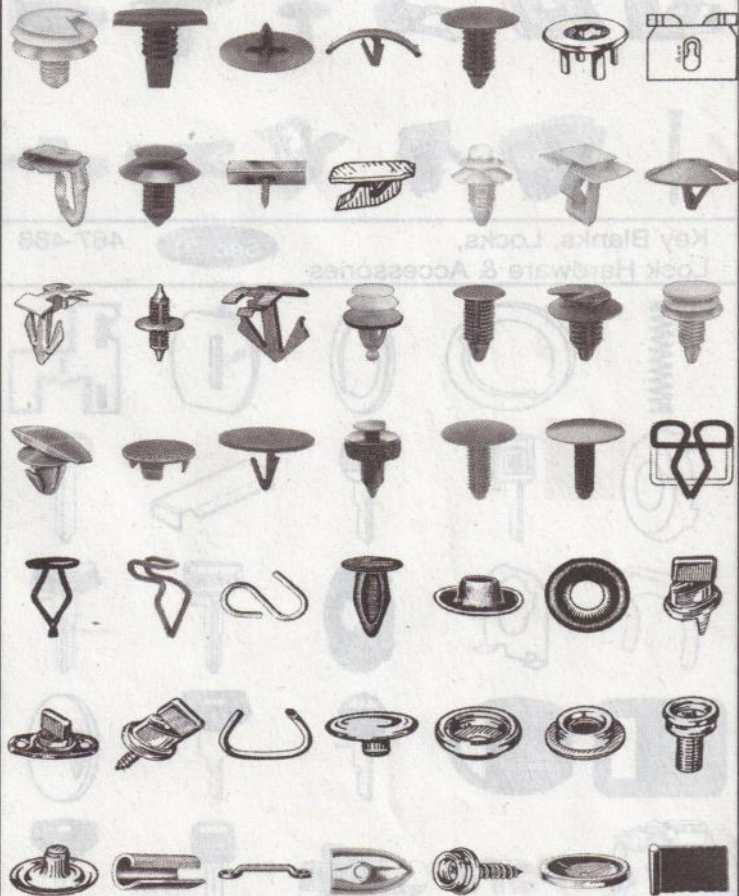

QUICK INDEX

AMC, Chrysler, Ford & GM
Clips And Fasteners

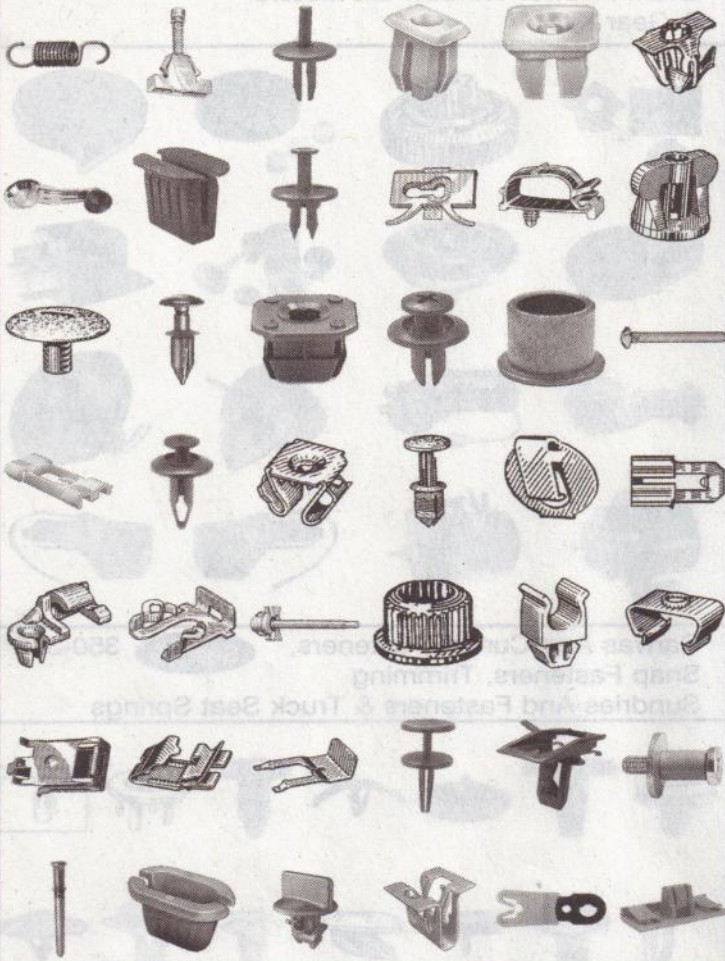

Import Car Clips
And Fasteners



Key Blanks, Locks,
Lock Hardware & Accessories

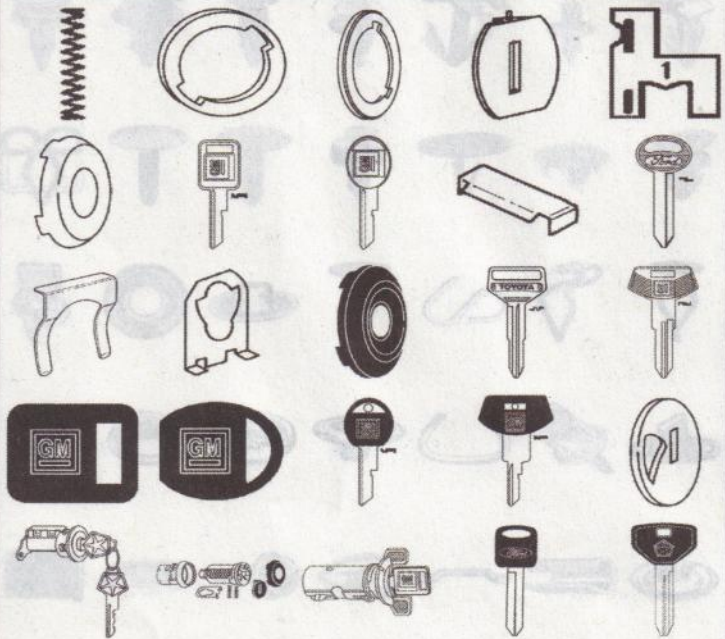

Universal Moulding Fasteners



QUICK INDEX

Ball Joint Assemblies

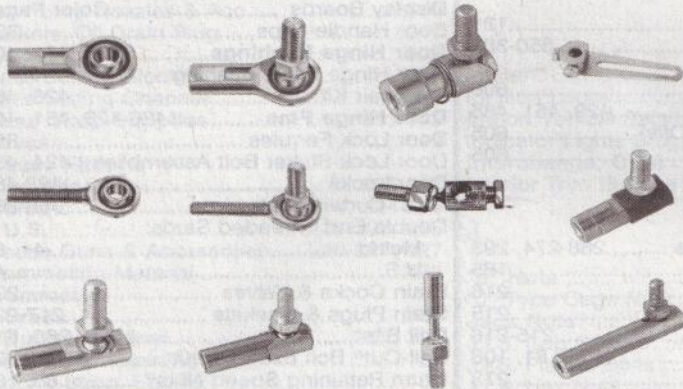

Miscellaneous Items

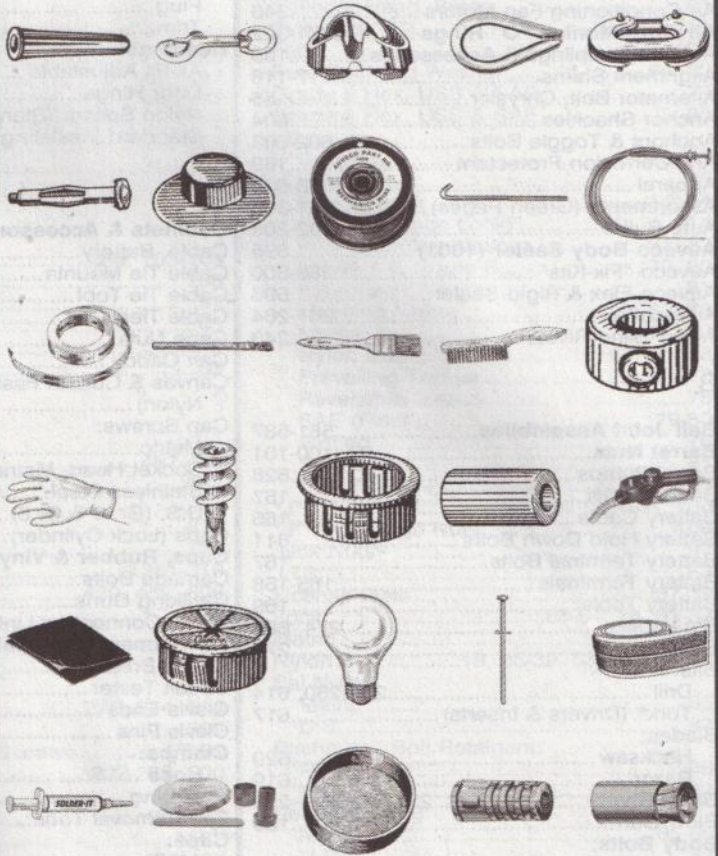

Hose Clamps & Tubing Clamps



Auveco Body Sealer, Seam Sealer, Seam-N-Joint Sealer, Auveco Flex, Rigid Set & Fixit Quik Epoxy Putty



Kraft Boxes, Tools & Lubrication Items

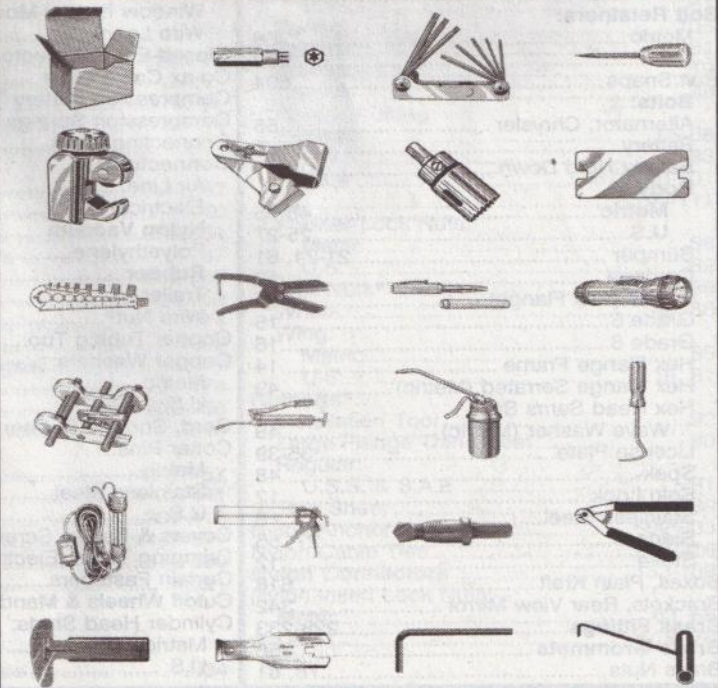

HEX MACHINE SCREW NUT



0/80" THRU 3/8" DIA. STEEL

CCU	ZINC - UNC	LINE 3-00
CCS	ZINC - UNF	4-00
DDU	PLAIN -UNC	5-00
DDS	PLAIN -UNF	6-00

NON FERROUS

VVU	304 STAINLESS	UNC
	LINE 1041-00	
VVS	304 STAINLESS	UNF
	LINE 1042-00	
XXU	316 STAINLESS	UNC
	LINE 1063-00	
XXS	316 STAINLESS	UNC
	LINE 1064-00	
WWU	BRASS	UNC
	LINE 1069-00	
WWS	BRASS	UNF
	LINE 1070-00	
UUU	SILICONE BRONZE	UNC
	LINE 1082-00	
UUS	SILICONE BRONZE	UNF
	LINE 1083-00	
ZZU	NYLON	UNC
	LINE 1086-00	
ZZS	NYLON	UNF
	LINE 1087-00	

GRADE 5 STANDARD HEX FINISHED NUT



APW	ZINC	UNC
	LINE 14-12	
APX	ZINC	UNF
	LINE 14-13	

GRADE 8 MADE IN U.S.A.

HEX FINISHED NUT



BDR	YEL/ZINC	UNC
	LINE 19-50	
BDT	YEL/ZINC	UNF
	LINE 19-51	

GRADE 8 STANDARD HEX FINISHED NUT



DND	YEL/ZINC	UNC
	LINE 22-00	
DPD	YEL/ZINC	UNF
	LINE 23-00	
EEU	PLAIN	UNC
	LINE 20-00	
EES	PLAIN	UNF
	LINE 21-00	

GRADE 8 MADE IN U.S.A. FINISHED THICK HEX NUTS

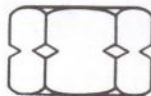

BDN	YEL/ZINC	UNC
	LINE 19-54	

GRADE 9

ACF	YEL/ZINC	UNC
	LINE 23-01	
ACG	YEL/ZINC	UNF
	LINE 23-02	

NON - FERROUS HEX FINISHED NUT



SSU	304 STAINLESS	UNC
	LINE 1043-00	
SSS	304 STAINLESS	UNF
	LINE 1044-00	
TTU	316 STAINLESS	UNC
	LINE 1065-00	
TTS	316 STAINLESS	UNF
	LINE 1065-00	
RRU	BRASS	UNC
	LINE 1071-00	
RRS	BRASS	UNF
	LINE 1073-00	
ANU	SIL BRONZE	UNC
	LINE 1084-00	
ABA	NYLON	UNC
	LINE 1088-00	
ACA	ALUMINUM	UNC
	LINE 1089-00	

HOT DIPPED GALVANIZED NUTS

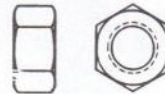

AWA	FINISHED	UNC
	LINE 85-00	

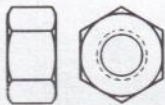

AXA	HEAVY GR 2	UNC
	LINE 86-00	
BDY	2H HVY	UNC
	LINE 86-01	

HEX JAM NUTS



FINISHED GRADE 2

GGU	ZINC	UNC
	LINE 11-00	
GGS	ZINC	UNF
	LINE 12-00	
FFU	PLAIN	UNC
	LINE 13-00	
FFS	PLAIN	UNF
	LINE 14-00	

HEX JAM NUTS



FINISHED GRADE 8

AYF	ZINC	UNC
	LINE 12-03	
AYG	ZINC	UNF
	LINE 12-04	

HEAVY JAM GRADE 2

ADA	PLAIN	UNC
	LINE 17-00	

NON - FERROUS FINISHED JAM

APU	304 STAINLESS	UNC
	LINE 1045-00	
APS	304 STAINLESS	UNF
	LINE 1046-00	
JJU	316 STAINLESS	UNC
	LINE 1066-00	
ARU	BRASS	UNC
	LINE 1074-00	
ARS	BRASS	UNF
	LINE 1075-00	
ASU	SIL BRONZE	UNC
	LINE 1085-00	

HEAVY JAM

JLJ	304 STAINLESS	UNC
	LINE 1047-01	

HEAVY HEX NUTS



GRADE 2 STEEL

ATU	PLAIN	UNC
	LINE 15-00	
AUU	ZINC	UNC
	LINE 16-00	

HARDENED STEEL

HHU	GRD2H PLAIN	NC
	LINE 28-00	
HHH	GRD2H PLN	UN8
	LINE 29-00	
HHD	GR2H ZINC	NC
	LINE 33-00	
HJD	GR2H ZINC	UN8
	LINE 34-00	
CGR	GRD DH PLN	UNC
	LINE 27-01	

CONTINUED NEXT PAGE

CONTINUED FROM PRECEEDING PAGE

HEAVY HEX NUTS



A325 STRUCTURAL

UHU PLAIN UNC
 LINE 26-00
 HKD ZINC UNC
 LINE 27-00

NON-FERROUS HEAVY HEX

DXC 304 STAINLESS UNC
 LINE 1047-00
 DYC 316 STAINLESS UNC
 LINE 1068-00
 DUD BRASS UNC
 LINE 1072-00

FINISHED NYLON INSERT LOCK NUTS GRADE 2 (A)

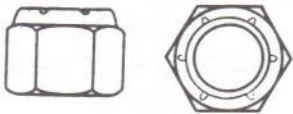

AVU ZINC UNC
 LINE 35-00
 AVS ZINC UNF
 LINE 36-00

GRADE 8 (C)

JXFU YEL/ZINC UNC
 LINE 41-01
 JXFS YEL/ZINC UNF
 LINE 41-01

STAINLESS STEEL

BMU 304 UNC
 LINE 1052-00
 BMS 304 UNF
 LINE 1053-00

N.U. SERIES HEAVY HEX NYLON INSERT LOCK NUTS

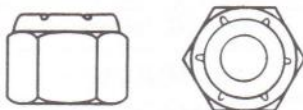

AGA GRD 2 ZINC UNC
 LINE 39-00

MACHINE SCREW NYLON INSERT LOCK NUTS



GRADE 2

AWU ZINC UNC
 LINE 31-00
 AWS ZINC UNF
 LINE 32-00

STAINLESS STEEL

BKU 304 UNC
 LINE 1048-00
 BKS 304 UNF
 LINE 1049-00
 #4 THRU #12 DIA.

HEX JAM NYLON INSERT LOCK NUTS

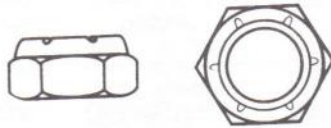

FINISHED GRADE 2

AXU ZINC UNC
 LINE 37-00
 AXS ZINC UNF
 LINE 38-00

HEAVY HEX JAM NUTS

AHA PLAIN UNC
 LINE 40-00

FINISHED STAINLESS STEEL HEX JAM NUTS

BLU 304SS UNC
 LINE 39-00
 BLS 304SS UNF
 LINE 40-00

HI-HEX NYLON INSERT LOCK NUTS



GRADE 2

AJA 3/8 - 24 THRU 1 1/4 - 12 ZINC UNF
 LINE 41-00

ALL METAL LOCK NUTS GRADE C, HEX, PREVAILING TORQUE CADMIUM AND WAX N.C./N.F. THREADS

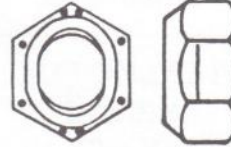

MADE IN U.S.A.

BDW ZINC UNC
 LINE 43-01
 BDX ZINC UNF
 LINE 43-02

ALL METAL FINISHED HEX CENTER 2/WAY LOCKNUT GRADE A,



ALL METAL FINISHED HEX TOP LOCKNUT GRADE A

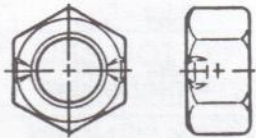

BXU ZINC UNC
 LINE 52-00
 BXS ZINC UNF
 LINE 53-00

ALL METAL LOCK NUT GRADE B, PREVAILING TORQUE ZINC PLATED*

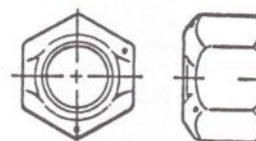

BSU ZINC UNC
 LINE 44-00
 BSS ZINC UNF
 LINE 45-00

ALL METAL LOCK NUTS GRADE C, PREVAILING TORQUE CADMIUM AND WAX

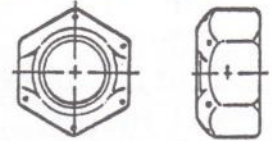

BRU ZINC UNC
 LINE 42-00
 BRS ZINC UNF
 LINE 43-00

GRADE 9 LOCK NUT

ACH YEL/CAD. UNC
 LINE 23-03
 ACJ YEL/CAD. UNF
 LINE 23-04

FLANGE AUTOMATION LOCKNUT GRADE G

POS & OIL 150K PSI

MADE IN U.S.A.

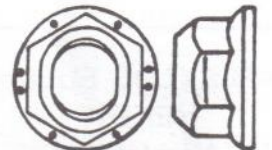

FOR USE WITH GRADE 8 FRAME BOLTS

BDP ZINC UNC
 LINE 23-07

FLANGE LOCK NUT ZINC YELLOW GRADE G

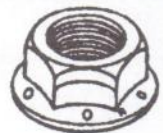





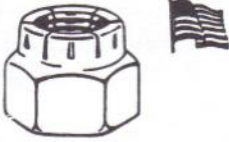

150K PSI
 JFS ZINC UNC
 LINE 23-05
 JGS ZINC UNF
 LINE 23-06

SERRATED HEX FLANGE NUTS

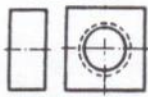
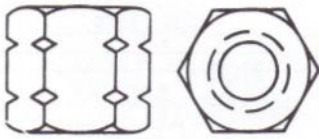

ZLB GR2 ZINC. UNC UNF
 LINE 95-00

<p>FLEXLOC NUTS</p>  <p>FLEXLOC LIGHT HEX FULL HEIGHT</p> <p>BTU CADMIUM UNC LINE 46-00 JKK PLAIN UNC LINE 46-01 BTS CADMIUM UNF LINE 47-00 JKK PLAIN UNF LINE 47-01 #4 THRU 1 1/2" DIA.</p>	<p>FINISHED JAM FLEXLOC NUT STAINLESS</p> <p>BWU UNC LINE 1056-00 BWS UNF LINE 1057-00 #6 THRU 1/2" DIA.</p>	<p>ROD COUPLING NUT</p> <p>10/24 1 1/2 DIA.</p> <p>ALA ZINC GR2 UNC ALAF ZINC GR2 UNF JFD LINE 84-00 STAINLESS UNC LINE 1062-00 1/4-20 THRU 3/4 - 10 DIA.</p>	<p>LEFT HAND THREAD HEX NUTS</p>  <p>GRADE 2</p> <p>BNU FINISHED HEX PLAIN UNC LINE 96-00 BNS FINISHED HEX PLAIN UNF LINE 97-00 1/4" THRU 1 1/2" DIA.</p>
<p>FLEXLOC LIGHT HEX THIN (JAM) HEIGHT</p> <p>BUU CADMIUM UNC LINE 48-00 JLK PLAIN UNC LINE 48-01 BUS CADMIUM UNF LINE 49-00 JMK PLAIN UNF LINE 49-01 #6 THRU 1 1/2" DIA.</p>	<p>FLEXLOC FULL HEIGHT HEAVY HEX NUT STAINLESS</p> <p>JRK UNC LINE 1057-01 1/4 THRU 1/2" DIA.</p>	<p>CASTLE NUTS</p>  <p>KKS ZINC UNF LINE 59-00 LLS PLAIN UNF LINE 61-00 KKU ZINC UNF SPECIAL LLU PLAIN UNF SPECIAL</p>	<p>FINISHED LEFT HAND HEX JAM NUTS</p> <p>BPU PLAIN UNC LINE 98-00 BPS PLAIN UNF LINE 99-00 1/4" THRU 1 1/2" DIA.</p>
<p>FLEXLOC FULL HEIGHT HEAVY HEX NUT</p> <p>APA PLAIN UNC LINE 50-00 JNK CADMIUM UNC LINE 50-01 1/4" THRU 2" DIA.</p>	<p>FLEXLOC THIN HEIGHT HVY HEX NUT STAINLESS</p> <p>JSK UNC LINE 1057-02</p>	<p>FINISHED SLOTTED NUT</p>  <p>NNU PLAIN UNC LINE 62-00 NNS PLAIN UNF LINE 63-00 DYD ZINC UNF LINE 68-00</p>	<p>HEAVY LEFT HAND FULL HEX NUTS</p> <p>AMA PLAIN UNC LINE 100-00 1/4" THRU 1 1/2" DIA</p>
<p>FLEXLOC THIN HEIGHT HEAVY HEX NUT</p> <p>AUA PLAIN UNC LINE 51-00 JPK CADMIUM UNC LINE 51-01 1/4" THRU 1 1/2" DIA.</p>	<p>METRIC FLEXLOC NUTS</p> <p>CEN STEEL - STAINLESS CER 1645-25 IN STOCK 1057-03</p> <p>"K" LOCK NUTS</p> <p>STEEL ZINC PLATED (KEPS NUTS)</p>  <p>BCU UNC LINE 54-00 BCS UNF LINE 55-00 #4 THRU 3/8" DIA.</p>	<p>FINISHED SLOTTED JAM NUT</p> <p>PPU PLAIN UNC LINE 64-00 PPS PLAIN UNF LINE 65-00</p>	<p>HEAVY LEFT HAND HEX JAM NUTS</p> <p>ANA PLAIN UNC LINE 101-00</p> <p>SQUARE MACHINE SCREW NUTS</p>  <p>ARA ZINC NC/NF LINE 87-00 ASA PLAIN NC/NF LINE 88-00 #2 THRU 1/2" DIA. JWZ 304 S/S UNC LINE 1062-03</p>
<p>FINISHED FLEXLOC NUT STAINLESS</p> <p>BVU UNC LINE 1054-00 BVS UNF LINE 1055-00 #2 THRU 1/2" DIA.</p>	<p>HEX HI-NUTS N.F. THREAD</p>  <p>GRADE 5</p> <p>AKA PLAIN UNF LINE 18-00 EAD ZINC UNF LINE 19-00 3/8 THRU 1 1/2" DIA.</p>	<p>HEAVY SLOTTED HEX NUT</p> <p>AEA PLAIN UNC LINE 66-00</p>	<p>REGULAR SQUARE NUTS</p>  <p>ATA PLAIN UNC LINE 89-00 DMD ZINC UNC LINE 91-00 JZH 304 S/S UNC LINE 1062-02</p> <p>HEAVY SQUARE NUT</p> <p>AVA PLAIN UNC LINE 90-00</p>

<p>WING NUTS</p>  <p>COLD FORGED</p> <p>AZU ZINC UNC LINE 72-00 AZS ZINC UNF LINE 73-00</p> <hr/> <p>STAINLESS</p> <p>BHU 304SS UNC LINE 1058-00 BHS 304SS UNF LINE 1059-00</p> <hr/> <p>BRASS</p> <p>BJU UNC LINE 1076-00 BJS UNF LINE 1077-00</p>	<p>HEX CAP NUTS</p>  <p>MILLED CAP NUT STEEL</p> <p>BEU ZINC UNC LINE 80-00 BES ZINC UNF LINE 81-00</p> <p>#6 THRU 3/4 DIA.</p> <hr/> <p>STAINLESS</p> <p>BFU 304SS UNC LINE 1060-00 BFS 304SS UNF LINE 1061-00</p> <p>#6 THRU 5/8 DIA.</p>	<p>WASHERS</p>  <p>MEGA THICK FLAT WASHERS THROUGH HARDENED R/C 38-45 HARDNESS</p> <p>YELLOW ZINC</p>  <p>THICKNESS RANGE .110 THRU .336 BASED ON DIAMETER</p> <p>USS PATTERN FAT LINE 111-10</p>	<p>COPPER BPA USS LINE 1103-00</p> <p>NYLON BWA LINE 1104-00</p> <p>ALUMINUM BVA LINE 1105-00</p> <p>U.S.S. FLAT WASHERS THROUGH HARDENED (ANSI B18.22.1, TYPE A, WIDE)</p>  <p>ZINC DICHROMATE (YELLOW) BBA LINE 111-00</p>
<p>WING NUTS</p>  <p>STAMPED</p> <p>AYU ZINC UNC LINE - 71 - 00</p> <p>6/32 THUR 3/8 - 16 DIA.</p>	<p>BRASS</p> <p>BGU UNC LINE 1078-00 BGS UNF LINE 1079-00 BZU NICKEL PLT. UNC LINE 1080-00 BZS NICKEL PLT. UNF LINE 1081-00</p> <p>#6 THRU 3/4" DIA. (VARIES)</p>	<p>SAE PATTERN</p> <p>MEG LINE 111-11 1/4 THRU 1 1/2 DIA.</p>	<p>S.A.E. FLAT WASHERS THROUGH HARDENED (ANSI B18.22.1, TYPE A, NARROW)</p>  <p>ZINC DICHROMATE (YELLOW) HGD LINE 113-00</p> <p>#10 THRU 2 1/2" DIA.</p>
<p>WING NUTS</p>  <p>WING TYPE LOCK NUTS</p> <p>ESD THREADED UNC LINE 74-00 6/32 THRU 5/16 DIA.</p>	<p>TWO PIECE HEX CAP NUTS</p>  <p>NICKLE PLATED</p> <p>BDU UNC LINE 78-00 BDS UNF LINE 79-00</p> <p>#6/32 THRU 3/8-16</p>	<p>USS STANDARD FLAT WASHER</p>  <p>GRADE 2</p> <p>CBU ZINC 100 PK LINE 103-00 HLD PLAIN 100 PK LINE 104-00 HMD ZINC 5# PK LINE 105-00 CAU PLAIN 5# PK LINE 102-00</p>	<p>FLAT WASHERS</p>  <p>IMPORT GRD 2</p> <p>ZINC PLATED 100 PK CCR USS 103-05 CCT SAE 103-06</p>
<p>TEE NUT</p>  <p>3 PRONG 4 PRONG</p> <p>AQA STEEL ZINC PLATED UNC/UNF LINE 92-00</p> <p>8/32 THRU 3/8-16 DIA.</p>	<p>PALNUT WASHER TYPE LOCK NUTS</p>  <p>ESD THREADED LINE 75-00</p> <p>#6 THRU 3/8</p>	<p>USS HOT DIP GALVANIZED FLAT WASHER</p>  <p>ANP PC/PK LINE 113-02</p>	<p>NON FERROUS STAINLESS STEEL</p> <p>CDU USS 304SS LINE 1090-00 BNA USS 316SS LINE 1096-00 CDS SAE 304SS LINE 1091-00</p>
<p>PALNUT SELF-THREADERS</p>  <p>ESD LINE 76-00</p> <p>3/32 THRU 3/8 STUD</p>	<p>SAE FLAT WASHER</p>  <p>GRADE 2</p> <p>CBS ZINC 100 PK LINE 107-00 HND PLAIN 100 PK LINE 108-00</p>	<p>BRASS</p> <p>CEU SAE LINE 1098-00 CES SAE USS LINE 1099-00</p>	<p>COPPER SEALING WASHER</p>  <p>BPA LINE 1102-00</p>

HEAVY DUTY THROUGH HARDENED FLAT WASHERS R/C 38-45 HARDNESS

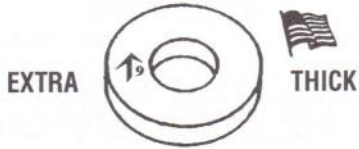

EXTRA THICK

ZINC DICHROMATE (YELLOW)
FOR USE WITH
GRADE 8 & 9 CAP SCREWS
USS PATTERN
BYP LINE 111-01
SAE PATTERN
BYR LINE 112-99

BELLEVILLE DISC SPRING WASHERS

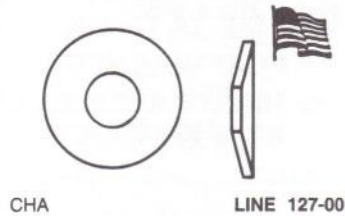

CHA LINE 127-00

1/8 THRU 1 1/2 DIA.
WASHER O.D. AND THICKNESS
VARIES BASED ON TENSION
REQUIREMENTS

SQUARE PLATE WASHERS



1/8 THRU 1/4" THICK

HOT DIP GALV.

1/2X 2" SQ
5/8 X 2 1/4"
3/4 X 2 1/4"
7/8 X 3"

BMN 113-03

HEAVY SPLIT LOCK WASHER

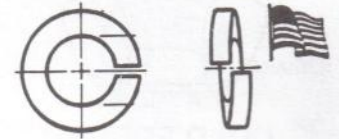

BCA ZINC STEEL

LINE 114-00
1/4" THRU 2" DIA.

LOCK WASHERS

SPLIT LOCK WASHER



REGULAR PATTERN

STANDARD SPRING STEEL
BCA ZINC LINE 114-00
BDA PLAIN LINE 115-00

ALLOY
YELLOW ZINC
BXJ LINE 114-10

LOCK SET WASHERS



ATM (PAIR) ZINC

3/16 THRU 1 1/2 DIA.
LINE 117-01

F436/A325/A490 HARDENED ROUND STRUCTURAL WASHERS



BAA PLAIN

LINE 112-00
1/4 THRU 2 1/2" DIA.

HOT DIP GALVANIZED

ASK LINE 112-01
1/2 THRU 1 1/2 DIA.

F436/A325/A490 HARDENED BEVELED WASHERS



CJA 1/2" TO 1" PLAIN

LINE 124-00

HOT DIP GALVANIZED

ANR LINE 115-01
1/4 THRU 1 1/2" DIA

NON - FERROUS

BMA 304 STAINLESS
LINE 1092-00
#2 THRU 1 1/4 DIA.

BTA 316 STAINLESS
LINE 1097-00
#6 THRU 1 1/4 DIA.

BSA SILICONE BRONZE
LINE 1101-00
#4 THRU 3/4 DIA.

BUA ALUMINUM
LINE 1106-00
#10 THRU 5/8 DIA.

TOOTH LOCKWASHER

INTERNAL TOOTH

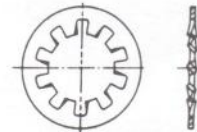

BFA STEEL ZINC

#2 THRU 1 1/4" DIA.
LINE 118-00

BKA STAINLESS STEEL

#3 THRU 3/4" DIA.
LINE 1093-00

BEVELED WASHERS MALLEABLE



GALVANIZED

CLA LINE 126-00

1/4 THRU 1 1/4 DIA.
PLAIN

CKA LINE 125-00

1/4 THRU 1 1/4 DIA.

HI-COLLAR LOCK WASHERS

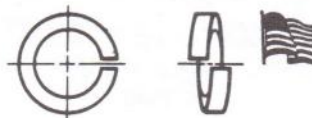

DXD STEEL ZINC
LINE 117-00

BEA STEEL PLAIN
LINE 116-00

#6 THRU 1 1/2 DIA.

STAINLESS STEEL

JPJ LINE 1092-01
1/4 THRU 5/8 DIA.

EXTERNAL TOOTH



BGA STEEL ZINC

#3 THRU 1 1/4" DIA.
LINE 119-00

BLA STAINLESS STEEL

#2 THRU 3/4 DIA.
LINE 1094-00

EXTERNAL COUNTERSUNK



BJA STEEL ZINC

#6 THRU 3/8" DIA.
LINE 121-00

FENDER WASHERS



ASJ 304SS 1091 - 10
AZA REG ZINC 110-00
BYN THICK ZINC 110-01

LINE 110-00

3/16 X 3/4 3/16 X 1
3/16 X 1 1/4 1/4 X 1
1/4 X 1 1/8 1/4 X 1 1/4
1/4 X 1 1/2 5/16 X 1 1/4
5/16 X 1 1/2 5/16 X 1 1/2 THK
3/8 X 1 1/4 3/8 X 1 1/2
3/8 X 1 5/8 1/2 X 1 1/2
1/2 X 2" 7/16 X 1 3/8

FOR CONSTRUCTION
1/2 X 2" OD X 1/8 THK PLN

BOWED / WAVE SPRING WASHER



EXD LINE 128-00
#4 THRU 1/2 DIA.

T-SLOT THICK BOTTOM WASHERS

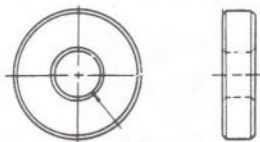

HEAT TREATED STEEL BLACK OXIDE FINISH

JGD LINE 137-00
1/4 THRU 1 1/4 DIA.

WASHERS RANGE FROM 1/8 THICK TO 5/16 THICK AS DIA. INCREASES



DOMESTIC HEX CAP SCREWS

TRACEABLE
MANUFACTURED BY LAKE ERIE AND NUCOR FASTENER

CERTIFICATIONS AVAILABLE

**U.S.S.
COARSE THREAD**

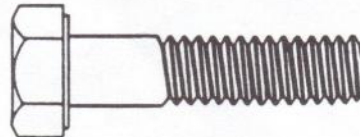

**S.A.E.
FINE THREAD**

AEU ZINC
LINE 143-00
ADU PLAIN
LINE 141-00

GRADE 5

AES ZINC
LINE 144-00
ADS PLAIN
LINE 142-00

1/4 X 1/2 THRU 1 1/4 X 10 SIZE RANGE

**U.S.S.
COARSE THREAD**

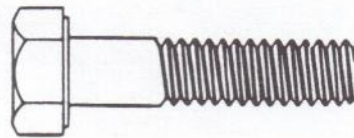

**S.A.E.
FINE THREAD**

DAD YELLOW ZINC
LINE 147-00
AFU PLAIN
LINE 145-00

GRADE 8

DBD YELLOW ZINC
LINE 148-00
AFS PLAIN
LINE 146-00

1/4 X 1/2 THRU 1 1/4 X 10 SIZE RANGE

DEFINITIONS RELATING TO CAP SCREWS

GRADE 5 - CAPSCREWS

A FASTENER MADE FROM MEDIUM CARBON STEEL THAT HAS BEEN HEAT TREATED TO ROCKWELL "C" 25-34 AND 120,000 P.S.I. MINIMUM FOR SIZES THROUGH 1" IN DIAMETER AND C19-30 AND 105,000 P.S.I. MINIMUM FOR DIAMETERS OVER 1". THREE RADIAL LINES 120° APART ALONG WITH THE MANUFACTURER'S IDENTIFICATION IS THE REQUIRED HEADMARKING.

GRADE 8 - CAPSCREWS

A FASTENER MADE FROM MEDIUM CARBON ALLOY STEEL THAT HAS BEEN HEAT TREATED TO ROCKWELL "C" 33-39 AND 150,000 P.S.I. MINIMUM TENSILE STRENGTH. SIX RADIAL LINES 60° APART ALONG WITH THE MANUFACTURER'S IDENTIFICATION IS THE REQUIRED HEADMARKING.

TOOTH LOCKWASHER
INTERNAL - EXTERNAL

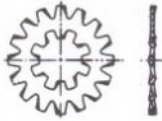

BHA STEEL ZINC
#6 THRU 3/4 DIA.
LINE 120-00

HEX CAP SCREWS / BOLTS
GRADE 2

1/4 THRU 1 1/2 DIA.



ACU U.S.S. ZINC
LINE 139-00
ABU U.S.S. PLAIN
LINE 138-00
JSD S.A.E. ZINC
LINE 139-02
JRD S.A.E. PLAIN
LINE 139-01

ALUMINUM

JYE U.S.S.
LINE 1113-01
1/4 THRU 3/4 DIAMETERS

STANDARD
HEX HEAD CAP SCREWS
GRADE 5
TRACEABLE



JJM U.S.S. ZINC
LINE 148-01
JJN U.S.S. PLAIN
LINE 148-02
JTR S.A.E. ZINC
LINE 148-03
JBP S.A.E. PLAIN
LINE 148-04
1/4 X 1/2 THRU 1 1/2 X 12"

COUNTERSUNK
FINISHING WASHER



APH STEEL NICKEL PLATED LINE 136-05
#6-#8-#10 DIA.
CGS STEEL ZINC LINE 136-06

HEX CAP SCREWS / BOLTS
GRADE 2
HOT DIP GALVANIZED



JEP U.S.S. HDG.
LINE 139-05
1/4 X 1/2 THRU 1" X 24" SIZE RANGE

STANDARD
HEX HEAD CAP SCREWS
GRADE 8 ALLOY
TRACEABLE
CERTIFICATIONS AVAILABLE



JKR U.S.S. YELLOW ZINC
LINE 148-05
JLR U.S.S. PLAIN
LINE 148-06
JAS S.A.E. YELLOW ZINC
LINE 148-07
JBS S.A.E. PLAIN
LINE 148-08
1/4 X 1/2 THRU 1 1/2 X 12"

MACHINERY
BUSHINGS



REGULAR MACHINERY
BUSHING

BZA 18GA LINE 129-00
CAA 14GA LINE 130-00
CBA 10GA LINE 131-00
CCA 3/16 THK LINE 132-00

SIZES TO 3 1/2" ID X 4 1/2" OD.

WIDE RIM
MACHINERY BUSHING

CDA 18GA. LINE 133-00
CEA 14GA. LINE 134-00
CFA 10GA. LINE 135-00

SIZE RANGE
2" X 1" THRU 4 1/4 X 3"

MACHINERY BUSHINGS
ARE EXACT DIMENSIONS
AS LISTED FOR
O.D. - I.D. - THK

HEX HEAD CAP SCREWS
NON-FERROUS



STAINLESS STEEL

AGU U.S.S. 304SS
LINE 1107-00
AGS S.A.E. 304SS
LINE 1108-00
CMA U.S.S. 316SS
LINE 1109-00
1/4 THRU 1 1/2" DIAMETER

BRASS

AHU U.S.S.
LINE 1110-00
AHS S.A.E.
LINE 1111-00
1/4 THRU 3/4 DIAMETERS

SILICON BRONZE

CNA U.S.S.
LINE 1112-00
1/4 THRU 3/4 DIAMETERS

NYLON

CPA U.S.S.
LINE 1113-00

HEX HEAD CAP SCREWS
LARGE DIAMETER LONG LENGTH

GRADE 8



JLR U.S.S. PLAIN
LINE 148-06
1" - 1 1/8" - 1 1/4" - 1 3/8" - 1 1/2" - 1 3/4" - 2" DIA.
12" TO 30" LENGTHS

**HEX HEAD CAP SCREWS
GRADE 9**

PROOF LOAD STRESS (PSI)	YIELD STRENGTH MIN. STRESS (PSI)	TENSILE STRENGTH MIN STRESS (PSI)
145,000	155,000	180,000

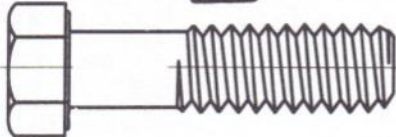

ACD U.S.S. YELLOW ZINC
ACE S.A.E. YELLOW ZINC
LINE 148-09
LINE 148-10
1/4 X 1/2 THRU 1 1/2 X 12"

BOLTS

HEX MACHINE BOLT

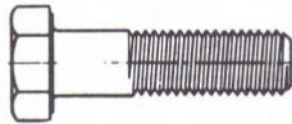

GRADE 2

CRA A307-A PLAIN
3/8 THRU 2" DIA.
LINE 149-00

HOT DIP GALVANIZED

JEP LINE 139-05
1/4 X 1/2 THRU 1 X 24"

**HEX BOLTS
ASTM A193 B-7**

JBG PLAIN
1/2 X 1 THRU 2" X 30"
LINE 154-01

HEAVY HEAD HEX BOLTS

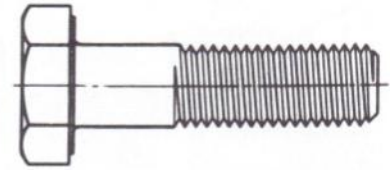

A-307B GRADE 2

JCD U.N.C. PLAIN
1/2 X 1 THRU 1 1/4 X 10
LINE 174-00

**ASTM A193 B-7
HEAVY HEAD HEX BOLTS**

JBG PLAIN
1/2 X 1 THRU 2" X 30"
LINE 154-01

**HOT FORGED
HEAVY HEAD HEX BOLTS**

GRADE 5

DEA U.N.C. PLAIN
LINE 150-00

GRADE 8

DFA U.N.C. PLAIN
LINE 151-00
5/8 X 12" THRU 2" X 30"

**HEX FLANGE SCREWS
N.C./N.F. THREADS
GRADE 8**

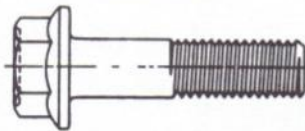

JHS U.S.S. PLAIN
LINE 167-05
JJS S.A.E. PLAIN
LINE 167-06
3/8 THRU 3/4 DIAMETER

**HEX HEAD BOLT
FULLY THREADED**

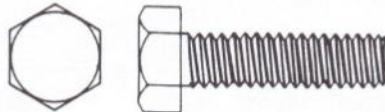

GRADE 2

DNC U.N.C. ZINC
LINE 140-00
1/4 X 1 1/4 THRU 3/4 X 6

GRADE 5

BML U.N.C. ZINC
1/4 X 1 1/4 THRU 3/4 X 4
LINE 140-01

STRUCTURAL BOLTS

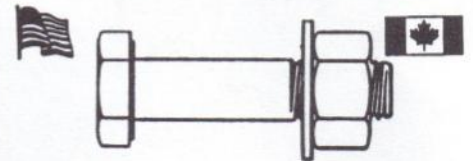

ASTM A325 TYPE 1

DJA WITH NUTS PLAIN
LINE 152-00
DLA NO/NUTS PLAIN
LINE 153-00

**ASTM A325
HOT DIP GALVANIZED**

BBT NO/NUTS
LINE 153-01

**12-POINT FLANGE SCREWS
PLAIN FINISH**

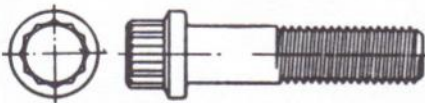

ALLOY STEEL

**TENSILE STRENGTH
170,000 P.S.I. MIN.**

THREADS
UNRC/UNRF CLASS 3A

KCA LINE 274-00
CGL 1/4 THRU 1 1/2" DIAMETER
METRIC LINE 1657-03

**SQUARE HEAD
MACHINE BOLTS**

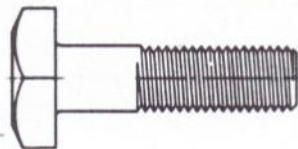

ASTM A307 GRADE 2

CWA PLAIN
LINE 158-00
DRD ZINC
LINE 159-00









1/4 X 1/2 THRU 1 1/2 X 20"
GRADE 5 & 8 AVAILABLE

ASTM A 490

GRADE 8

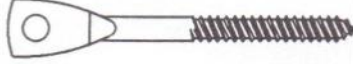
DKA WITH NUTS PLAIN
LINE 154-00

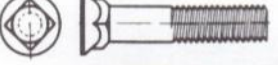
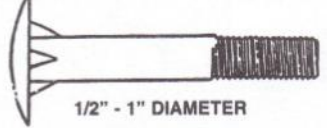
TRACEABLE
CERTIFICATIONS AVAILABLE

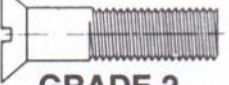
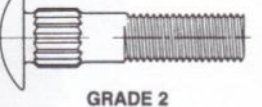
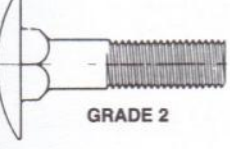
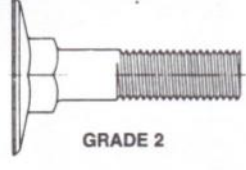
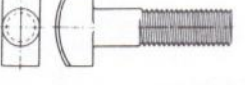
<p>CARRIAGE BOLTS</p>  <p>GRADE 2</p> <p>CTA ZINC CSA PLAIN</p> <p>LINE 156-00 (OVER 6") LINE 155-00</p>	<p>HEX HEAD LAG SCREWS</p>  <p>GRADE 2</p> <p>HUA ZINC</p> <p>LINE 172-00</p>	<p>HANGER BOLTS</p> <p>GRADE 2</p>  <p>HXA ZINC</p> <p>LINE 171-00</p> <p>10/24 THRU 3/8 DIA.</p>	<p>HEX HEAD BOLT EXTRA LENGTH & EXTRA THREAD LENGTH</p>  <p>HOT DIP GALVANIZED</p> <p>4" TO 8" OF THREAD GRADE 2</p> <p>1/2 DIA X 12" - 14" - 16" 5/8 DIA X 14" - 16" - 18" - 20" 3/4 DIA X 14" - 16" - 18" - 20" - 22" - 24" 7/8 DIA X 12" - 14" - 16" - 18" - 20" 1" DIA. X 12" - 14" - 16" - 18" - 20" - 24"</p> <p>JEP <u>LINE 139-05</u></p>
<p>GRADE 5</p> <p>DBA PLAIN</p> <p>LINE 157-00</p>	<p>HOT DIP GALVANIZED</p> <p>ANT GRD 2</p> <p>LINE 173-01</p> <p>1/4 X 1 THRU 3/4 X 12</p>	<p>ACOUSTICAL LAG SCREW</p>  <p>ALY ZINC</p> <p>1/4 DIA. X 3, 4, 5"</p> <p>LINE 171-02</p>	<p>STAINLESS STEEL 304SS</p> <p>AGU <u>LINE 1107-00</u></p> <p>5/8 DIA X 10" - 12" - 14" 3/4 DIA X 10" - 11" - 12" - 14"</p>
<p>HOT DIP GALVANIZED</p> <p>ANS H.D.G.</p> <p>LINE 157-03</p>	<p>STAINLESS STEEL 304SS</p> <p>HWA</p> <p>LINE 1115-00</p> <p>1/4 X 1 THRU 1/2 X 6</p>	<p>WOOD DOWEL SCREWS</p>  <p>ALW PLAIN</p> <p>3/16 THRU 3/8 DIA.</p> <p>LINE 171-01</p>	<p>STAINLESS STEEL 316SS</p> <p>CMA <u>LINE 1109-00</u></p> <p>5/8 DIA X 12" - 14" - 16" 3/4 DIA X 14" - 18"</p>
<p>STAINLESS STEEL 304SS</p> <p>CXA</p> <p>LINE 1116-00</p>	<p>#3 HEAD PLOW BOLTS</p>  <p>GRADE 5</p> <p>EHD ZINC</p> <p>LINE 166-00</p>	<p>TIMBER BOLTS</p>  <p>BMM U.N.C.</p> <p>1/2" - 1" DIAMETER</p> <p>HOT DIPPED GALVANIZED</p> <p>LINE 157-04</p>	<p>SQUARE HEAD SET SCREWS</p>  <p>KBA ALLOY KGA 304SS</p> <p>LINE 273-00 LINE 1181-00</p>
<p>SILICON BRONZE U.N.C.</p> <p>JGY</p> <p>LINE 1116-01</p>	<p>GRADE 8</p> <p>DCA DOME ZINC</p> <p>LINE 165-00</p> <p>5/8 X 1 1/2 THRU 1 1/4 X 8</p>	<p>CONCRETE ANCHOR BOLTS</p>  <p>WITH NUTS & WASHERS PLAIN & GALVANIZED</p> <p>JRF <u>LINE 145-50</u></p> <p>3/8" THRU 1 1/4 DIA. 6" THRU 18" LENGTH SPECIAL SIZES AVAILABLE</p>	
<p>ALUMINUM U.N.C.</p> <p>JHY</p> <p>LINE 1116-02</p>	<p>SLOTTED FLAT HEAD CAP SCREWS</p>  <p>GRADE 2</p> <p>CYA U.N.C. PLAIN EGD U.N.C. ZINC</p> <p>LINE 168-00 LINE 170-00</p>		
<p>CARRIAGE BOLTS RIBBED NECK</p>  <p>GRADE 2</p> <p>JHK U.N.C. ZINC</p> <p>LINE 157-01</p>	<p>GRADE 5</p> <p>CZA U.N.C. PLAIN</p> <p>LINE 169-00</p>		
<p>STEP BOLTS</p>  <p>GRADE 2</p> <p>CUA U.N.C. ZINC</p> <p>LINE 160-00</p>	<p>STAINLESS STEEL 304SS</p> <p>DUC</p> <p>LINE 1114-00</p>		
<p>ELEVATOR BOLTS</p>  <p>GRADE 2</p> <p>CVA U.N.C. ZINC</p> <p>LINE 162-00</p> <p>1/4 X 3/4 THRU 3/8 X 3"</p>	<p>T-HEAD BOLTS</p>  <p>JEG <u>LINE 175-00</u></p>		

Unbrako HEX SOCKET HEAD CAP SCREWS

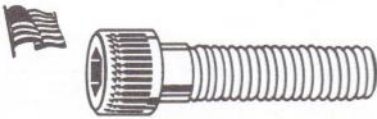

HYA HYAS ALLOY ALLOY U.N.C./U.N.F.
0/80 THRU 1 1/2 DIA.
LINE 253-00

STANDARD QUALITY

JMR JMRS ALLOY ALLOY U.N.C./U.N.F.
#6 THRU 1 1/2 DIA.
LINE 286-05

SELF LOCKING NYLON-PATCH / PELLET

JBA ALLOY U.N.C./U.N.F.
LINE 255-00

STAINLESS STEEL

JAA 304SS U.N.C.
LINE 1156-00
JKJ 316SS U.N.C.
LINE 1156-01

SILICON BRONZE

JCJ U.N.C.
LINE - 1161 - 04

Unbrako FLAT HEAD SOCKET CAP SCREWS



JCA JCAS ALLOY ALLOY U.N.C./U.N.F.
LINE 256-00

STANDARD QUALITY

JPR JPRS ALLOY ALLOY U.N.C./U.N.F.
LINE 286-07

SELF LOCKING NYLON-PATCH / PELLET

JFA (S) 304SS U.N.C./U.N.F.
LINE 259-00

STAINLESS STEEL

JEA (S) 304SS U.N.C./U.N.F.
LINE 1157-00

Unbrako BUTTON HEAD SOCKET CAP SCREWS



JGA (S) ALLOY U.N.C./U.N.F.
#6 THRU 5/8 DIA.
LINE 260-00

STANDARD QUALITY

ABS (S) ALLOY U.N.C./U.N.F.
LINE 286-08

SELF LOCKING NYLON-PATCH/PELLET

JKA (S) ALLOY U.N.C./U.N.F.
LINE 262-00

STAINLESS STEEL

JJA 304SS U.N.C.
LINE 115 -00

Unbrako LOW HEAD SOCKET CAP SCREWS



JLA ALLOY U.N.C.
#8 THRU 1/2" DIA.
LINE 263-00

Unbrako HEX SOCKET SET SCREWS

CUP POINT
JMA (S) ALLOY U.N.C./U.N.F.
LINE 264-00

KNURLED POINT
JWA (S) ALLOY U.N.C./U.N.F.
LINE 271-00

HALF DOG POINT
JUA (S) ALLOY U.N.C./U.N.F.
LINE 269-00

CONE POINT
JTA (S) ALLOY U.N.C./U.N.F.
LINE 268-00

FLAT POINT
JSA (S) ALLOY U.N.C./U.N.F.
LINE 267-00

OVAL POINT
JVA (S) ALLOY U.N.C./U.N.F.
LINE 270-00

HEX SOCKET SET SCREWS STANDARD QUALITY



CUP POINT
JNR (S) ALLOY U.N.C./U.N.F.
LINE 286-06

SELF LOCKING NYLON-PATCH / PELLET

JRA (S) ALLOY U.N.C./U.N.F.
LINE 266-00

STAINLESS STEEL

JPA (S) 304SS U.N.C./U.N.F.
LINE 1159-00

JCK 316SS U.N.C.
LINE 1160-01

JYA (304SS PELLET) U.N.C.
LINE 1160-00

LOCKING SOCKET SET SCREWS



JXA (S) ALLOY U.N.C./U.N.F.
LINE 272-00

INTERNAL WRENCHING ALLEN NUTS



JHD (S) ALLOY U.N.C./U.N.F.
LINE 286-00

Unbrako SHOULDER SCREWS SOCKET HEAD

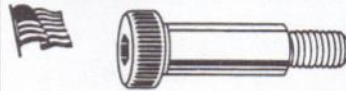









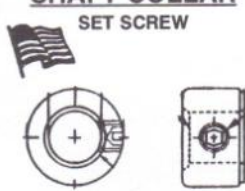

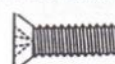

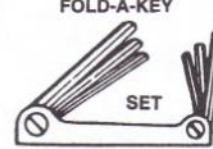
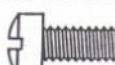
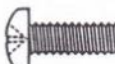





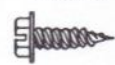
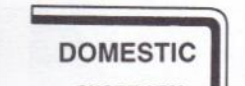
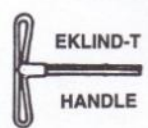
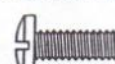
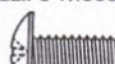

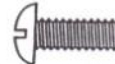

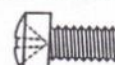

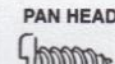
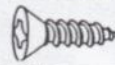

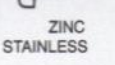
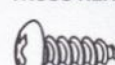

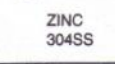
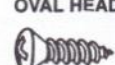
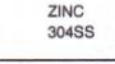
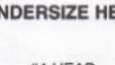





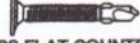

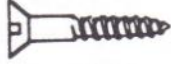







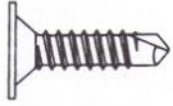





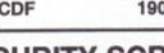



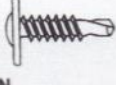





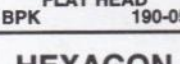
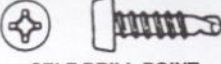

KJA ALLOY LINE 276-00
JFK 304SS LINE 1160-02





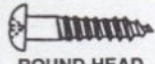

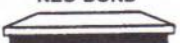
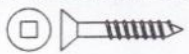







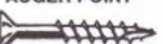

Unbrako PRESSURE PLUGS DRYSEAL



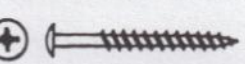

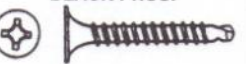
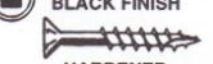
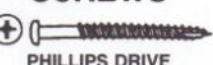
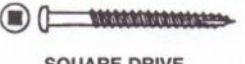

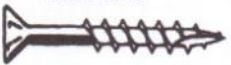



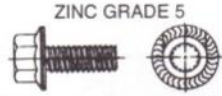

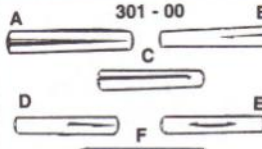

MEB ALLOY 3/4 TAPER
LINE 283-00
MFB ALLOY 7/8 TAPER FLUSH
LINE 284-00
MGB 304SS 3/4 TAPER
LINE 285-00











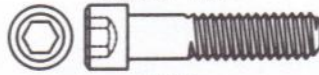
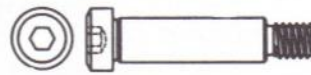

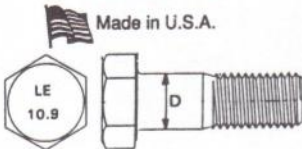
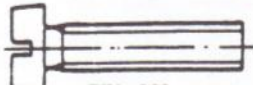
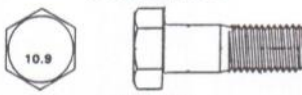
<p>SHAFT COLLAR SET SCREW</p>  <p>HED STEEL ASH 304SS</p> <p>LINE 286-01 LINE 285-75</p>	<p>POUCH SETS</p> <table border="0"> <tr><td>ZWB</td><td>6 PC</td><td>.028-3/32 SA</td></tr> <tr><td>ZWB</td><td>7 PC</td><td>5/64-1/4 SA</td></tr> <tr><td>ZWB</td><td>6 PC</td><td>.050-5/32 SA</td></tr> <tr><td>ZWB</td><td>11 PC</td><td>.050-3/8 SA</td></tr> <tr><td>ZWB</td><td>7 PC</td><td>5/64-1/4 12"</td></tr> <tr><td>ZWB</td><td>9 PC</td><td>5/64-3/8 6"</td></tr> <tr><td>ZWB</td><td>19 PC</td><td>.028-3/4 SA</td></tr> <tr><td>ZWB</td><td>15 PC</td><td>5/64-3/4 LA</td></tr> <tr><td>ZWB</td><td>9 PC</td><td>5/64-1/4 SA</td></tr> <tr><td>ZWB</td><td>15 PC</td><td>.028-3/8 SA</td></tr> <tr><td>AMB</td><td>9 PC</td><td>5/64-1/4 SA</td></tr> <tr><td>ZWB</td><td>8 PC</td><td>.050-7/32 SA</td></tr> <tr><td>ZWB</td><td>11 PC</td><td>5/64-9/16 SA</td></tr> <tr><td>ZWB</td><td>13 PC</td><td>.050-3/8 SA</td></tr> <tr><td>ZWB</td><td>13 PC</td><td>.050-3/8 LA</td></tr> <tr><td>ZWB</td><td>11 PC</td><td>5/64-3/8 6"</td></tr> </table> <p>METRIC</p> <table border="0"> <tr><td>ZWB</td><td>7 PC</td><td>M2-M-8</td></tr> <tr><td>ZWB</td><td>9 PC</td><td>M1.5-M-10.0</td></tr> <tr><td>ZWB</td><td>9 PC</td><td>M1.5-M-10 LA</td></tr> </table>	ZWB	6 PC	.028-3/32 SA	ZWB	7 PC	5/64-1/4 SA	ZWB	6 PC	.050-5/32 SA	ZWB	11 PC	.050-3/8 SA	ZWB	7 PC	5/64-1/4 12"	ZWB	9 PC	5/64-3/8 6"	ZWB	19 PC	.028-3/4 SA	ZWB	15 PC	5/64-3/4 LA	ZWB	9 PC	5/64-1/4 SA	ZWB	15 PC	.028-3/8 SA	AMB	9 PC	5/64-1/4 SA	ZWB	8 PC	.050-7/32 SA	ZWB	11 PC	5/64-9/16 SA	ZWB	13 PC	.050-3/8 SA	ZWB	13 PC	.050-3/8 LA	ZWB	11 PC	5/64-3/8 6"	ZWB	7 PC	M2-M-8	ZWB	9 PC	M1.5-M-10.0	ZWB	9 PC	M1.5-M-10 LA	<p>SLOTTED FLAT HEAD</p>  <p>JAK NYLON DNA ZINC EFD PLAIN ECA 304SS EHA 316SS EKA BRASS JES STOVE BO ZINC</p> <p>LINE 1127-17 177-00 184-00 1118-00 1123-00 1125-00 184-02</p>	<p>PHILLIPS FLAT HEAD</p>  <p>DWA ZINC JFJ STAINLESS JJJ BRASS CFD 100*HD ZINC</p> <p>LINE 186-00 1127-03 1127-09 186-01</p>	<p>OVAL HEAD</p>  <p>FPA ZINC GDA 304SS</p> <p>LINE 220-00 1132-00</p>
ZWB	6 PC	.028-3/32 SA																																																											
ZWB	7 PC	5/64-1/4 SA																																																											
ZWB	6 PC	.050-5/32 SA																																																											
ZWB	11 PC	.050-3/8 SA																																																											
ZWB	7 PC	5/64-1/4 12"																																																											
ZWB	9 PC	5/64-3/8 6"																																																											
ZWB	19 PC	.028-3/4 SA																																																											
ZWB	15 PC	5/64-3/4 LA																																																											
ZWB	9 PC	5/64-1/4 SA																																																											
ZWB	15 PC	.028-3/8 SA																																																											
AMB	9 PC	5/64-1/4 SA																																																											
ZWB	8 PC	.050-7/32 SA																																																											
ZWB	11 PC	5/64-9/16 SA																																																											
ZWB	13 PC	.050-3/8 SA																																																											
ZWB	13 PC	.050-3/8 LA																																																											
ZWB	11 PC	5/64-3/8 6"																																																											
ZWB	7 PC	M2-M-8																																																											
ZWB	9 PC	M1.5-M-10.0																																																											
ZWB	9 PC	M1.5-M-10 LA																																																											
<p>SPLIT COLLARS</p>  <p>DRC 1 PC STEEL DSC 1 PC - 2 PC 304SS JND 2 PC STEEL</p> <p>LINE 286-02 LINE 286-04 LINE 286-03</p>	<p>FOLD-A-KEY SET</p>  <p>LINE - 281 - 00</p> <table border="0"> <tr><td>ZYB</td><td>9 BIT</td><td>5/64-1/4</td></tr> <tr><td>ZYB</td><td>5 BIT</td><td>3/16-3/8</td></tr> <tr><td>ZYB</td><td>9 BIT</td><td>.050-3/16</td></tr> <tr><td>ZYB</td><td>7 BIT</td><td>TORX</td></tr> <tr><td>ZYB</td><td>7 BIT</td><td>M2-M8</td></tr> <tr><td>ZYB</td><td></td><td>M1.5-M6</td></tr> <tr><td>ZYB</td><td></td><td>M-4M10</td></tr> </table>	ZYB	9 BIT	5/64-1/4	ZYB	5 BIT	3/16-3/8	ZYB	9 BIT	.050-3/16	ZYB	7 BIT	TORX	ZYB	7 BIT	M2-M8	ZYB		M1.5-M6	ZYB		M-4M10	<p>SLOTTED FILLISTER HEAD</p>  <p>DUA ZINC EMA BRASS JEF STAINLESS</p> <p>LINE 182-00 1127-00 1121-02</p>	<p>PHILLIPS PAN HEAD</p>  <p>DYA ZINC JLF STAINLESS</p> <p>LINE 189-00 1127-05</p>	<p>HEXAGON HEAD ZINC</p>  <p>FNA SLT HEX WASH FNA HEX WASH HD JWJ STAINLESS</p> <p>LINE 219-00 218-00 1128-01</p>																																				
ZYB	9 BIT	5/64-1/4																																																											
ZYB	5 BIT	3/16-3/8																																																											
ZYB	9 BIT	.050-3/16																																																											
ZYB	7 BIT	TORX																																																											
ZYB	7 BIT	M2-M8																																																											
ZYB		M1.5-M6																																																											
ZYB		M-4M10																																																											
<p>BALL END HEX KEYS</p>  <p>INCH - METRIC KEYS & SETS AKD</p> <p>278-03</p>	<p>HEX T-KEYS CUSHION GRIP</p>  <p>AKK 3/32-3/8 AKK M2-M6 AKJ 10 PC INCH SET 3/32-3/8</p> <p>LINE - 279 - 05</p>	<p>SLOTTED PAN HEAD</p>  <p>DSA ZINC EEA 304SS ELA BRASS JBF 316SS CCF NYLON</p> <p>LINE 180-00 1120-00 1126-00 1120-01 1127-18</p>	<p>PHILLIPS OVAL HEAD</p>  <p>DZA ZINC JMF STAINLESS</p> <p>LINE 189-00 1127-06</p>	<p>SELF PIERCING SCREWS HARDENED STEEL ZINC PLATED HEX WASHER SLOTTED</p>  <p>FNA NEEDLE POINT</p> <p>LINE - 219 - 01</p>																																																									
<p>HEX KEYS DOMESTIC</p>  <p>SHORT ARM LONG ARM 6" LONG ARM 12" LONG ARM SHORT IMP. LONG IMP.</p> <p>DKC LINE-277-00 DLC LINE-278-00 AJY LINE-278-01 AJZ LINE-278-02 CFV LINE-278-08 CFW LINE-278-09</p>	<p>EKLIND-T HANDLE</p>  <p>ZXB 3/32-3/8 ZXB M2-M10</p> <p>3" - 6" - 9" LINE - 280 - 00 ZZB 10 PC SET LINE - 282 - 00</p>	<p>SLOTTED BINDING HEAD</p>  <p>JVZ ZINC ELA BRASS</p> <p>LINE 182-01 1126-00</p>	<p>PHILLIPS TRUSS HEAD</p>  <p>DXA ZINC JKF STAINLESS</p> <p>LINE 187-00 1127-04</p>	<p>PHILLIPS TAPPING SCREWS</p> <p>PAN HEAD</p>  <p>FRA ZINC GEA 304SS GEAB 304SS BLACK</p> <p>LINE 221-00 1133-00 1133-00</p>																																																									
<p>HEX KEY SETS</p>  <p>POUCH</p> <p>ZWB LINE - 279 - 00 ALB METAL BOX LINE - 279 - 01 ABM PLASTIC BOX/SLEEVE LINE - 279 - 02</p> <p>ALL SETS IN METRIC OR INCH SERIES</p>	<p>SLOTTED MACHINE SCREWS</p> <p>SLOTTED ROUND HEAD</p>  <p>AYH BRNZ JZE ALUM JSJ NYLON DMA ZINC EED PLAIN EBA 304SS EGA 316SS EJA BRASS JDS STV BO ZINC</p> <p>LINE 1125-02 1127-01 1127-15 176-00 183-00 1117-00 1122-00 1124-00 184-01</p>	<p>HEXAGON HEAD</p>  <p>DRA ZINC EFA 304SS JYJ NYLON CCP WASH HD ZINC</p> <p>LINE 179-00 1121-00 1127-16 179-01</p>	<p>PHILLIPS FILLISTER HEAD</p>  <p>EAA ZINC</p> <p>LINE 190-00</p>	<p>ROUND HEAD</p>  <p>FSA ZINC GJA 304SS</p> <p>LINE 222-00 1137-00</p>																																																									
		<p>SLOTTED OVAL HEAD</p>  <p>DTA ZINC JVE STAINLESS DTC WALL PLATE</p> <p>LINE 181-00 1121-01 181-05</p>	<p>SLOTTED TAPPING SCREWS</p> <p>PAN HEAD</p>  <p>FJA ZINC FZA STAINLESS</p> <p>LINE 214-00 1128-00</p>	<p>FLAT HEAD</p>  <p>FTA ZINC GFA 304SS GFAB 304SS BLACK</p> <p>LINE 223-00 1134-00 1134-00</p>																																																									
		<p>SLOTTED TRUSS HEAD</p>  <p>DPA ZINC EDA 304SS</p> <p>LINE 178-00 1119-00</p>	<p>ROUND HEAD</p>  <p>FKA ZINC GBA 304SS</p> <p>LINE 215-00 1130-00</p>	<p>TRUSS HEAD</p>  <p>FUA ZINC GHA 304SS</p> <p>LINE 225-00 1136-00</p>																																																									
		<p>PHILLIPS MACHINE SCREWS</p> <p>PHILLIPS ROUND HEAD</p>  <p>DVA ZINC JRG STAINLESS</p> <p>LINE 185-00 1127-07</p>	<p>FLAT HEAD</p>  <p>FLA ZINC GAA 304SS</p> <p>LINE 216-00 1129-00</p>	<p>OVAL HEAD</p>  <p>FVA ZINC GGA 304SS</p> <p>LINE 225-00 1135-00</p>																																																									
			<p>TRUSS HEAD</p>  <p>FMA ZINC GCA 304SS</p> <p>LINE 217-00 1131-00</p>	<p>OVAL HEAD TRIM SCREW (UNDERSIZE HEAD)</p>  <p>FWA #4 HEAD FXA #6 HEAD FYA #8 HEAD FAD CROME</p> <p>LINE 227-00 228-00 230-00 231-00</p>																																																									

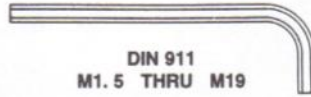
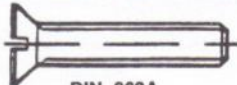
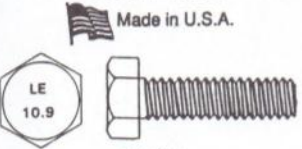
<p>SELF TAPPING SCREWS TYPE A PAN HEAD COMBINATION PHILLIPS & SLOTTED</p>  <p>LINE 226-01</p> <p>APD ZINC</p>	<p>SNAKE EYES SPANNER MACHINE SCREWS 18-8 STAINLESS STEEL</p>  <p>LINE 190-04</p> <p>BED PAN</p>	<p>METAL TO WOOD CONSTRUCTION SCREWS</p>  <p>SHARP DRILL POINT NEO-BONDED WASHER ASSORTED HEAD COLORS CDE 239-75</p>	<p>WOOD TO METAL SELF DRILLING SCREWS PHILLIPS WAFER</p>  <p>PHILLIPS FLAT COUNTERSUNK</p>  <p>LINE 240-01</p> <p>JPD STEEL</p> <p>DOMESTIC PARKER KALON</p> <p>BZT 239-11</p>	<p>SLOTTED WOOD SCREWS</p>  <p>FLAT HEAD LINE</p> <table border="0"> <tr><td>HDA</td><td>241-00</td><td>ZINC</td></tr> <tr><td>HEA</td><td>242-00</td><td>PLAIN</td></tr> <tr><td>HNA</td><td>1146-00</td><td>STAINLESS</td></tr> <tr><td>HJA</td><td>1147-00</td><td>BRASS</td></tr> <tr><td>HSA</td><td>1152-00</td><td>ALUMINUM</td></tr> <tr><td>HRA</td><td>1151-00</td><td>SIL BRNZ</td></tr> </table>	HDA	241-00	ZINC	HEA	242-00	PLAIN	HNA	1146-00	STAINLESS	HJA	1147-00	BRASS	HSA	1152-00	ALUMINUM	HRA	1151-00	SIL BRNZ										
HDA	241-00	ZINC																														
HEA	242-00	PLAIN																														
HNA	1146-00	STAINLESS																														
HJA	1147-00	BRASS																														
HSA	1152-00	ALUMINUM																														
HRA	1151-00	SIL BRNZ																														
<p>SQUARE DRIVE PAN HEAD SHEET METAL SCREWS</p>  <p>LINE 225-03</p> <p>BBL ZINC</p>	<p>LINE 190-04</p> <p>BED FLAT</p>  <p>LINE 190-04</p> <p>BED OVAL</p> 	<p>HEXAGON SELF SEALING DRILL SCREWS (TEK STYLE)</p>  <p>#2 PT</p>  <p>#3 PT</p>  <p>#4 PT</p>  <p>#5 PT</p> <p>LINE 237-00</p> <p>GVA STEEL Z/P</p> <p>ARX 237-02 410 ST/STL</p>	<p>PHILLIPS FLAT WAFER DRILL SCREWS ZINC</p>  <p>#3 PT</p> <p>JPD 240-01</p> <p>DOMESTIC PARKER KALON</p> <p>BZR 239-10</p>	<p>ROUND HEAD LINE</p> <table border="0"> <tr><td>HFA</td><td>243-00</td><td>ZINC</td></tr> <tr><td>HKA</td><td>1148-00</td><td>BRASS</td></tr> <tr><td>HTA</td><td>1153-00</td><td>ALUMINUM</td></tr> </table>  <p>OVAL HEAD LINE</p> <table border="0"> <tr><td>HGA</td><td>244-00</td><td>ZINC</td></tr> <tr><td>HLA</td><td>1149-00</td><td>BRASS</td></tr> </table> 	HFA	243-00	ZINC	HKA	1148-00	BRASS	HTA	1153-00	ALUMINUM	HGA	244-00	ZINC	HLA	1149-00	BRASS													
HFA	243-00	ZINC																														
HKA	1148-00	BRASS																														
HTA	1153-00	ALUMINUM																														
HGA	244-00	ZINC																														
HLA	1149-00	BRASS																														
<p>TAMPER RESISTANT 18-8 STAINLESS STEEL TAPPING SCREWS ONE - WAY</p>  <p>LINE 190-02</p> <p>BDZ ROUND</p>	<p>SECURITY SCREWS PIN TORX 18-8 STAINLESS TAPPING SCREWS</p>  <p>FLAT HEAD</p>  <p>BUTTON HEAD</p>  <p>CDF 190-08</p>	<p>HEX WASHER HEAD DRILL SCREWS (TEK STYLE)</p>  <p>LINE</p> <table border="0"> <tr><td>GZA</td><td>#2 PT</td><td>238-00</td><td>STEEL</td></tr> <tr><td>HAA</td><td>#3 PT</td><td>239-00</td><td>STEEL</td></tr> <tr><td>ARY</td><td>#2 PT</td><td>238-01</td><td>410 SS</td></tr> <tr><td>ARZ</td><td>#3 PT</td><td>239-01</td><td>410 SS</td></tr> </table>	GZA	#2 PT	238-00	STEEL	HAA	#3 PT	239-00	STEEL	ARY	#2 PT	238-01	410 SS	ARZ	#3 PT	239-01	410 SS	<p>K-LATH SCREWS SHARP POINT</p>   <p>CBT 239-75</p> <p>SELF DRILL POINT</p>   <p>CCN 240-15</p>	<p>PHILLIPS WOOD SCREWS</p>  <p>FLAT HEAD LINE</p> <table border="0"> <tr><td>HHA</td><td>245-00</td><td>ZINC</td></tr> <tr><td>ASL</td><td>1153-02</td><td>BRASS</td></tr> <tr><td>BEF</td><td>1153-03</td><td>STAINLESS</td></tr> <tr><td>CZB</td><td>1153-04</td><td>SILBRNZ</td></tr> </table>	HHA	245-00	ZINC	ASL	1153-02	BRASS	BEF	1153-03	STAINLESS	CZB	1153-04	SILBRNZ
GZA	#2 PT	238-00	STEEL																													
HAA	#3 PT	239-00	STEEL																													
ARY	#2 PT	238-01	410 SS																													
ARZ	#3 PT	239-01	410 SS																													
HHA	245-00	ZINC																														
ASL	1153-02	BRASS																														
BEF	1153-03	STAINLESS																														
CZB	1153-04	SILBRNZ																														
<p>LINE 190-02</p> <p>BDZ OVAL</p> 	<p>SECURITY SCREWS MACHINE SCREWS 18-8 STAINLESS</p>  <p>BUTTON HEAD</p>  <p>FLAT HEAD</p>  <p>BPK 190-05</p>	<p>DOMESTIC PARKER KALON</p> <table border="0"> <tr><td>BZM</td><td>#2 PT</td><td>238-02</td><td>STEEL</td></tr> <tr><td>BZN</td><td>#3 PT</td><td>239-02</td><td>STEEL</td></tr> <tr><td>BZP</td><td>#4 PT</td><td>239-03</td><td>STEEL</td></tr> <tr><td>BZQ</td><td>#5 PT</td><td>239-03</td><td>STEEL</td></tr> </table>	BZM	#2 PT	238-02	STEEL	BZN	#3 PT	239-02	STEEL	BZP	#4 PT	239-03	STEEL	BZQ	#5 PT	239-03	STEEL	<p>PHILLIPS PAN FRAMING SCREWS</p>   <p>SELF DRILL POINT</p>  <p>SHARP POINT BLACK FINISH</p> <p>HBA 240-00</p>	<p>PHILLIPS</p>  <p>OVAL HEAD LINE</p> <table border="0"> <tr><td>JEK</td><td>245-02</td><td>ZINC</td></tr> <tr><td>JVH</td><td>1153-01</td><td>BRASS</td></tr> </table>	JEK	245-02	ZINC	JVH	1153-01	BRASS						
BZM	#2 PT	238-02	STEEL																													
BZN	#3 PT	239-02	STEEL																													
BZP	#4 PT	239-03	STEEL																													
BZQ	#5 PT	239-03	STEEL																													
JEK	245-02	ZINC																														
JVH	1153-01	BRASS																														
<p>MACHINE SCREWS ONE WAY</p>  <p>LINE 190-01</p> <p>BDZ ROUND</p>	<p>HEXAGON SELF SEALING TAPPING SCREWS</p>  <p>LINE</p> <table border="0"> <tr><td>GUA</td><td>236-00</td><td>STEEL Z/P</td></tr> <tr><td>ARW</td><td>236-01</td><td>410 ST/STL</td></tr> <tr><td>AZV</td><td>236-02</td><td>316 ST/STL</td></tr> <tr><td>BEE</td><td>236-03</td><td>304 ST/STL</td></tr> </table>	GUA	236-00	STEEL Z/P	ARW	236-01	410 ST/STL	AZV	236-02	316 ST/STL	BEE	236-03	304 ST/STL	<p>PHILLIPS PAN DRILL SCREW #2 PT</p>  <p>LINE 240-00</p> <p>HBA STEEL</p>	<p>SQUARE DRIVE TRIM HEAD</p>   <p>DRILL OR SHARP POINT</p> <p>BBR 240-07</p>	<p>ROUND HEAD LINE</p> <table border="0"> <tr><td>JPG</td><td>245-01</td><td>ZINC</td></tr> </table> 	JPG	245-01	ZINC													
GUA	236-00	STEEL Z/P																														
ARW	236-01	410 ST/STL																														
AZV	236-02	316 ST/STL																														
BEE	236-03	304 ST/STL																														
JPG	245-01	ZINC																														
<p>TAMPER RESISTANT 18-8 STAINLESS STEEL SNAKE EYES SPANNERS TAPPING SCREWS</p>  <p>LINE 190-03</p> <p>BED PAN</p>	<p>SEALING WASHER NEO-BOND</p>  <p>LINE</p> <table border="0"> <tr><td>JZX</td><td>237-01</td><td>GALV. STEEL</td></tr> <tr><td>JZXS</td><td>237-01</td><td>STAINLESS</td></tr> </table>	JZX	237-01	GALV. STEEL	JZXS	237-01	STAINLESS	<p>DOMESTIC PARKER KALON BZV #2 PT 239-12</p>	<p>SQUARE DRIVE FLAT WOOD SCREWS</p>  <p>HARDENED CAW</p> <table border="0"> <tr><td>ZINC</td><td>245-06</td></tr> </table>	ZINC	245-06	<p>U-DRIVE SCREWS</p>  <p>ROUND HEAD LINE</p> <table border="0"> <tr><td>ZUB</td><td>250-00</td><td>ZINC</td></tr> <tr><td>ZVB</td><td>1167-00</td><td>STAINLESS</td></tr> </table> <p>00 THRU #14 DIA.</p>	ZUB	250-00	ZINC	ZVB	1167-00	STAINLESS														
JZX	237-01	GALV. STEEL																														
JZXS	237-01	STAINLESS																														
ZINC	245-06																															
ZUB	250-00	ZINC																														
ZVB	1167-00	STAINLESS																														

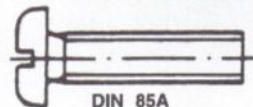
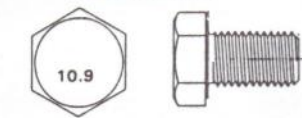
<p>DRY WALL SCREWS BUGLE HEAD</p>	<p>SQUARE DRIVE DECK SCREWS #2 HARDENED</p>  <p>ALL WEATHER DACRO COAT CCZ _____ 240-23 YELLOW ZINC CCY _____ 240-24 STAINLESS STEEL CAX _____ 240-08</p>	<p>CABINET SCREWS & HARDWARE</p>	<p>ROUND WASHER SQUARE DRIVE HEAD</p> <p>#2 ZINC PLTD</p>  <p>DEEP THREAD #8X1 THRU #8X4" CCW - 245-13</p>	<p>OVERHEAD GARAGE DOOR FASTENERS</p>
<p>FINE THREAD PHILLIPS BLACK PHOS.</p>  <p>LINE 240-02 STEEL</p>	<p>WOOD WORKING & CABINET SCREWS</p>	<p>COMBO DRIVE TRUSS HD. MACHINE SCREWS</p>  <p>FOR DECORATIVE HARDWARE</p> <p>ZINC PLATED 8/32 X 3/8 THRU Z" CCX - 184-12</p>	<p>MODIFIED TRUSS W/EXTRA LARGE WASHER HEAD</p> <p>PHILLIPS DRIVE</p>  <p>DEEP THREAD #8X7/8 THRU 1-3/4 CCW - 245-14</p>	<p>HEXAGON TAPPING SCREWS 7/16 HEAD</p>  <p>ZINC PLATED 14X3/4 W/SERRATIONS 14X1 NO/SER. 5/16X1-5/8 NO/SER. 5/16X1-5/8 HIGH HD. 5/16X 2-1/2 NO/SER CCV - 245-10</p>
<p>COARSE THREAD PHILLIPS BLACK PHOS.</p>  <p>LINE 240-03 STEEL</p>	<p>SUPER WOODIES NIBBED HEAD AUGER POINT</p>  <p>PH COMBO DRIVE SQ HARDENED BLACK FINISH AUB - 240-10</p>	<p>UNIVERSAL BREAK-AWAY COMBO-DRIVE MACHINE SCREWS</p>  <p>FOR DECORATIVE HARDWARE ZINC PLATED</p> <p>INCH 8/32 X 3/4 - 1 - 1-1/4 - 1-1/2 - 1-3/4 METRIC M4 X 19-25-32-38-45 CCX - 184-13</p>	<p>EURO DRAWER SLIDE SCREWS 7.5 MM HEAD</p>  <p>M5 X 13MM HARDENED NICKEL PLATED CCW - 245-18</p>	<p>HEXAGON WASHER HEAD DRILL SCREWS 7/16 HEAD</p>  <p>SERRATED HEAD #14X3/4 ZINC PLATED CCV - 245-10</p>
<p>HIGH-LOW THREAD PHILLIPS BLACK PHOS.</p>  <p>LINE 240-05 STEEL</p>	<p>STANDARD WOODIE NIBBED HEAD PHILLIPS DRIVE</p>  <p>HARDENED BLACK FINISH AUD - 240-11</p>	<p>HINGE & DRAWER SLIDE SCREWS</p>  <p>PHILLIPS OVAL PHILLIPS OVAL NICKEL - ANTIQUE BRASS PLATING #5X1/2 THRU #6X5/8 CCW - 245-15</p>	<p>PAINTED PHILLIPS TRUSS CABINET TO WOOD STUD INSTALLATION</p>  <p>DEEP THREAD STANDARD POINT NEEDLE POINT SDS DRILL POINT COLORS WHITE - SAND BLACK - ZINC #8-#10X 2-1/2 & 3" CCW - 245-12</p>	<p>FLAT HEAD CARRIAGE SCREW 5/8 AF HEAD</p>  <p>ZINC PLATED 1/4-20X1-7/8 1/4-20X2" 1/4-20X2-1/4 CCV - 245-10</p>
<p>SELF DRILLING (TEK STYLE) BLACK PHOS.</p>  <p>LINE 240-04 STEEL</p>	<p>STANDARD WOODIE NIBBED HEAD SQUARE DRIVE BLACK FINISH HARDENED</p>  <p>AUE - 240-12</p>	<p>PAN HEAD FACE FRAMING SCREWS</p>  <p>PHILLIPS DRIVE</p>  <p>SQUARE DRIVE AUGER POINT BLACK FINISH #6X1-1/4 & 1-1/2 CCW - 245-16</p>	<p>BEAUTY CAP SCREW COVERS 1/2" DIA.</p>  <p>FOR PHILLIPS & SQUARE DRIVE COLORS ALMOND - BLACK DARK BROWN LIGHT GRAY WHITE CCW - 245-11</p>	<p>GARAGE DOOR RAIL TRACK SCREWS</p>  <p>ZINC PLATED 1/4-20X5/8 SLOTTED RIBBED NECK CCV - 245-10</p>
<p>EXTERIOR DECK SCREWS PHILLIPS</p>  <p>LINE ALL WEATHER DACRO COAT ATL _____ 240-06 YELLOW - ZINC ATL _____ 240-25 304 STAINLESS ATLSS _____ 240-09</p>	<p>ALL WEATHER WOODIE DECKING SCREWS HARDENED</p>  <p>SQUARE DRIVE AUGER POINT AUH - 240-13</p>	<p>DRAW BOLTS</p>  <p>1/4 - 20 X 3-1/2 CCW - 245-17</p>	<p>DRY WALL SCREWS PACKED IN 100-500-1000 & BULK PACK QUANTITIES</p>	<p>SERATED FLANGE NUTS</p>  <p>ZINC PLTD ZLB - 95-00</p>

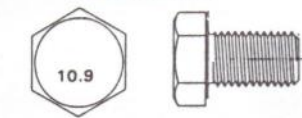
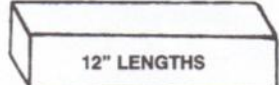
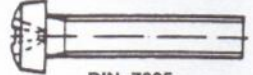
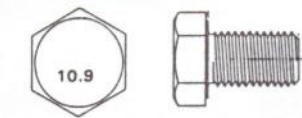
<p>THREAD CUTTING MACHINE SCREWS SLOTTED TYPE F</p>  <p>LINE ERA 193-00 PAN HD. ENA 191-00 ROUND HD. EUA 198-00 TRUSS HD. EPA 192-00 FLAT HD. ETA 196-00 HEX HD. EYD 197-00 SLOT HEX HD. EVA 199-00 OVAL HD. EWA 200-00 FILLISTER HD.</p>	<p>SERRATED HEX FLANGE SCREWS ZINC GRADE 5</p>  <p>CAV 184-12 #10 THRU 3/8" DIA.</p>	<p>SAFETY SNAP PINS</p>  <p>STYLE 1 JYG 316-02 STEEL</p>	 <p>301-00 GROOVE PINS DGC ALL STYLES PLAIN 1/16" THRU 3/8" DIA.</p>	<p>ROUND STOCK WBB 321-00 STEEL WCB 1171-00 BRASS 3/16" THRU 1" DIA. 3 FOOT LENGTHS</p>
<p>THREAD CUTTING MACHINE SCREWS PHILLIPS TYPE F</p>  <p>LINE EZA 203-00 PAN HD. EXA 201-00 ROUND HD. EYA 202-00 FLAT HD. FBA 207-00 OVAL HD. JUN 202-01 TRUSS HD.</p>	<p>THREAD CUTTING FLOOR BOARD SCREWS</p>  <p>SLOTTED FLAT HEAD LINE ESA 195-00 ZINC 1/4" THRU 5/16" DIA. TO 6" LENGTH</p>	<p>LINCH PINS</p>  <p>KEA 316-03 STEEL</p>	<p>TAPER PINS DEC 302-00 STEEL DEF 1168-00 STAINLESS 00 THRU #10 DIA.</p>	<p>STUDS DOUBLE END STUDS JXH 325-03 GRADE B7 JAH 325-02 GRADE 2 JXE 1166-02 STAINLESS DMC 1623-00 BWP LISTED STUDS AVAILABLE ON SPECIAL ORDER MADE TO SIZE</p>
<p>THUMB SCREWS TYPE P</p>  <p>LINE KEA 246-00 ZINC KHA 1154-00 304 SS JAJ 1155-01 BRASS</p>	<p>PHILLIPS FLAT HEAD FAA 205-00 ZINC 1/4" THRU 5/16" DIA. TO 3" LENGTH</p>	<p>UNIVERSAL CLEVIS PIN KNA 289-00 STEEL ZINC PLTD. 3/16" THRU 5/8" DIA. TO 4" LENGTH</p>	<p>KEYS 12" LENGTHS KEY STOCK ARP 305-02 STAINLESS DJC 305-00 SQ. ZINC DHC 304-00 RECT. CAM 304-01 ALLOY DJCM 305-00 MILLED 1/8" THRU 2" DIA JBD12-31 ASSORTMENT</p>	<p>FULL THREAD STUDS WFB 324-00 GR2 WGB 325-00 B7 JWE 1166-01 ST/STEEL 304/316</p>
<p>TYPE S</p>  <p>LINE KFA 247-00 ZINC ABL 1155-00 304 SS</p>	<p>FLAT TORX DRIVE HFD 206-00 PHOS & OIL 1/4" & 5/16" DIA. TO 3 1/2" LENGTH</p>	<p>REGULAR CLEVIS PIN LINE KLA 299-00 PLAIN KMA 300-00 ZINC 3/16" THRU 1 1/4" DIA. TO 9" LENGTH</p>	<p>WOODRUFF KEYS DDC 306-00 STEEL 1/16" THRU 3/8" THICK DDC 306-00 ALLOY</p>	<p>METRIC RETAINING RINGS EXTERNAL CFR 311-25 INTERNAL CFS 311-26 E-STYLE CFT 311-27</p>
<p>THREAD FORMING TRILOBE SCREWS</p>  <p>SAE J81 ZINC - BAKE - WAX CFE PHILPAN 207-02 CFF HEX 207-03</p>	<p>PINS COTTER PINS LINE KWA 287-00 PLAIN LAA 289-00 ZINC LBA 1164-00 STAINLESS LCA 1165-00 BRASS 1/32" THRU 3/4" DIA.</p>	<p>TENSION (SPLIT) PIN LINE KTA 239-00 PLAIN KUA 295-00 ZINC KVA 1163-00 STAINLESS</p>	<p>THREADED RODS GRADE 2 FULL THREADED ROD LINE ALU 319-00 ZINC UNC ALS 319-00 ZINC UNF AKU 318-00 PLAIN UNC BTC 1660-00 ZINC--METRIC ATG 319-01 HOT DIP GALV. 4/40" THRU 2" DIA. 3-6-12 FOOT LENGTHS</p>	<p>PLIERS CFX EXT 314-01 CFY INT 314-02</p>
<p>EXTERNAL SEMS MACHINE SCREWS</p>  <p>ZINC - BAKE DBU PHILPAN 190-22 DHU HEX 190-24 INTERNAL SEMS STOCKED</p>	<p>HAMMERLOCK COTTER PINS</p>  <p>JXG 289-01 ZINC</p> <p>HAIR PIN COTTERS ZRB 315-00 ZINC .0295 THRU .306 DIA.</p> <p>HAIR PIN CLIPS ZSB 315-00 ZINC .029 THRU .125 DIA.</p>	<p>SPIRAL PINS JWG 295-01 STEEL PLAIN</p>	<p>DOMESTIC DOWEL PINS LINE KRA 291-00 ALLOY .002 STANDARD KSA 1162-00 304SS .002 STANDARD</p>	<p>RETAINING RINGS LINE 308-00 EXTERNAL RETAINING RING YUB STEEL PLAIN 1/8" THRU 2 1/2" SHAFT</p>
	<p>HITCH PINS</p>  <p>JNF 316-01 STEEL</p>	<p>IMPORT BEL 291-01 ALLOY .002 STANDARD METRIC CFN 1657-02 ALLOY</p>	<p>NONFERROUS FULL THREADED ROD KYA 1166-00 304 SS LEA 1169-00 316 SS KZA 1170-00 BRASS LDA 1172-00 ALUM #10 THRU 2" DIA. 3-6 FOOT LENGTHS</p>	<p>LINE 309-00 INTERNAL RETAINING RING YVB STEEL PLAIN 1/4" THRU 2 3/8" SHAFT</p>
		<p>PULL-OUT DOWEL PINS ABR 292-01 ALLOY</p>	<p>MACHINING DRILL ROD WDB 322-00 OIL WEB 323-00 WATER 5/64" THRU 1 1/2" DIA. 3 FOOT LENGTHS</p>	<p>LINE 310-00 EXTERNAL "C" RINGS YWB STEEL PLAIN 1/8" THRU 1 1/2" SHAFT</p>

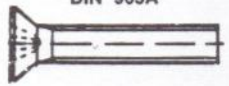
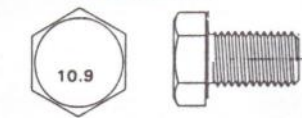
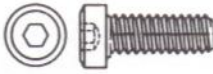
<p>METRIC FASTENERS</p> <p>METRIC HEX NUTS</p> <p>DIN 934 CLASS 8 BNC PLATED</p> <p>M6 THRU M36 COARSE - FINE - X-FINE 1644 - 00</p>	<p>METRIC NYLON INSERT LOCK NUT</p> <p>DIN 985 PLATED</p> <p>BRC CLASS 8 1646-00 CBB CLASS 10 1645-99 AAV STAINLESS 1646-02</p>	<p>METRIC LOCK WASHER</p> <p>DIN 127 B M2 THRU M30 PLATED BWC 1649 - 00 A2 STAINLESS BST DIN127 1670-06</p>	<p>HEX HEAD METRIC CAP SCREWS FINE THREAD</p> <p>8.8 CLASS = (GRD 5) DIN 960 PARTIALLY THREADED FINE PITCH AAW PLATED LINE - 1642 - 06</p> <p>AAT PLAIN LINE - 1642 - 05 M8 THRU M24</p>
<p>STAINLESS A2</p> <p>BSN 1670-08</p>	<p>METRIC ALL STEEL LOCK NUT CLASS 10</p> <p>DIN 980V PLATED BSF 1646-01</p>	<p>METRIC EXTERNAL TOOTH LOCK WASHER</p> <p>DIN 6797 TYPE A BXC PLATED M2 THRU M20 LINE - 1650 - 00</p>	<p>HEX HEAD METRIC CAP SCREWS</p> <p>8.8 CLASS = (GRD 5) DIN 933 FULLY THREADED COARSE THRD. JPN PLATED 1642 - 02 BLC PLAIN 1642 - 00</p>
<p>METRIC HEX NUTS</p> <p>DIN 934 PROPERTY CLASS 10 ATT PLATED</p> <p>M6 THRU M36 COARSE - FINE - X-FINE LINE - 1644 - 03</p>	<p>METRIC HEX FLANGE NUTS</p> <p>DIN 6923 Cl. 10 BME ZINC M6 THRU M16 LINE - 1647 - 01</p>	<p>METRIC INTERNAL TOOTH LOCKWASHER</p> <p>DIN 6797 TYPE J BYC PLATED M2 THRU M20 LINE - 1651 - 00</p>	<p>STAINLESS A2</p> <p>BSL 1670-00</p>
<p>METRIC HEX MACHINE SCREW NUTS</p> <p>DIN 439 B Cl. 04 BPC - PLATED</p> <p>M2 THRU M8 LINE - 1645 - 00</p>	<p>METRIC FLAT WASHERS</p> <p>DIN 125 A CLASS 8</p> <p>M3 THRU M30 BUC 1648-00 PLATED ABG 1647-05 PLAIN A2 STAINLESS BSM 1670-04</p>	<p>METRIC SPRING WAVE WASHER</p> <p>DIN 137 TYPE B BVC PLATED M3 THRU M20 LINE - 1652 - 00</p>	<p>HEX HEAD METRIC CAP SCREWS FINE THREAD</p> <p>8.8 CLASS = (GRD 5) DIN 961 FULLY THREADED FINE THREAD AAX PLATED LINE - 1642 - 07</p> <p>JTN PLAIN LINE - 1642 - 04 M8 THRU M24</p>
<p>METRIC HEX JAM NUTS</p> <p>DIN 936 CLASS 8 BSC - PLATED</p> <p>M6 THRU M30 LINE - 1647 - 00</p>	<p>METRIC FLAT WASHER WITH CHAMFER</p> <p>DIN 125 B CLASS 8 ABE PLATED M6 THRU M36 LINE - 1647 - 04</p>	<p>HEX HEAD METRIC CAP SCREWS</p> <p>8.8 CLASS = (GRD 5) DIN 931 PARTIALLY THREADED COARSE THD JRN PLATED LINE - 1642 - 03 BMC PLAIN LINE - 1642 - 01 M4 THRU M30</p>	<p>METRIC 10.9 HEX FLANGE BOLTS</p> <p>DIN 6921 COARSE THREAD BMF PHOS / OIL LINE - 1643 - 20 M6 THRU M16 DIA.</p>
<p>METRIC WING NUTS</p> <p>BTV STEEL Z/P 1646-03 BSV ST/STL 1670-09</p>	<p>METRIC FLAT WASHERS</p> <p>THRU - HARDENED DIN 125 A CLASS 10 ABK PLATED M6 THRU M36 LINE - 1647 - 06</p>		

<p>METRIC FASTENERS</p>	<p>METRIC SOCKET HEAD CAP SCREW DIN 912 12.9</p>  <p>ALLOY CDC PLAIN 1653-00</p>	<p>METRIC SOCKET HEAD SHOULDER SCREWS 12.9 ISO 7379</p>  <p>M6 THRU M24 BMK POLISHED 1657-01</p>	<p>METRIC COTTER PINS</p>  <p>DIN 94 BZC PLATED 1661-00 BTR STAINLESS 1661-01</p>
<p>METRIC 10.9 HEX HEAD CAP SCREWS</p>  <p>Made in U.S.A. DIN 931 PARTIALLY THREADED COARSE THREAD AAR PLATED LINE - 1643 - 04 JSN PLAIN LINE - 1643 - 02 M6 THRU M24 DIA.</p>	<p>STAINLESS A2 BSW 1670-20</p>	<p>A2 STAINLESS CDP 1670-24</p>	<p>METRIC MACHINE SCREWS</p> <p>SLOTTED CHEESE HEAD</p>  <p>DIN 84A CGC PLATED LINE - 1662 - 00</p>
<p>METRIC 10.9 HEX HEAD CAP SCREWS</p>  <p>DIN 960 PARTIALLY THREADED FINE THREAD BMG PLATED LINE - 1643 - 05 M3 THRU M24 DIA.</p>	<p>METRIC FLAT SOCKET HEAD CAP SCREWS DIN 7991 10.9</p>  <p>ALLOY CFC PLAIN 1654-00</p>	<p>METRIC SOCKET KEY</p>  <p>DIN 911 M1.5 THRU M19 AKE SHORT 278-04 AKF LONG 278-05 AKD BALL END 278-03</p>	<p>SLOTTED FLAT HEAD</p>  <p>DIN 963A CHC PLATED 1662-01 CBX STAINLESS 1670-12</p>
<p>METRIC 10.9 HEX HEAD CAP SCREWS</p>  <p>Made in U.S.A. DIN 933 FULLY THREADED COARSE THREAD AAP PLATED LINE - 1643 - 03 M6 THRU M24 DIA.</p>	<p>STAINLESS A2 BTW 1670-22</p>	<p>METRIC FOLD-A-KEY SET</p>  <p>LINE 281-00 ZYBM17 M1.5 - M6 ZYBM15 M4 - M10 ZYB45SPS M2 - M8</p>	<p>SLOTTED PAN HEAD</p>  <p>DIN 85A CJC PLATED 1663-00 CBW STAINLESS 1670-11</p>
<p>METRIC 10.9 HEX HEAD CAP SCREWS</p>  <p>DIN 961 FULLY THREADED FINE THREAD BMH PLATED LINE - 1643 - 06 M8 THRU M24</p>	<p>METRIC SOCKET SET SCREWS</p>  <p>ALLOY CUP POINT DIN 916 45H CCC PLAIN 1655 - 00</p>	<p>METRIC BALL END FOLD-A-KEY SET AKD13613SET 1.3-17M 278-03</p>	<p>PHILLIPS OVAL HEAD</p>  <p>DIN 966A CLC PLATED 1667-00 BTX STAINLESS 1670-17</p>
<p>METRIC 10.9 HEX HEAD CAP SCREWS</p>  <p>DIN 933 FULLY THREADED COARSE THREAD AAP PLATED LINE - 1643 - 03 M6 THRU M24 DIA.</p>	<p>STAINLESS A2 BSX 1670-21</p>	<p>METRIC KEY STOCK</p>  <p>12" LENGTHS M2 THRU M25 LINE BTT 305-04 STEEL BSK 305-03 ST/STL</p>	<p>PHILLIPS PAN HEAD</p>  <p>DIN 7985 CNC PLATED 1665-00 BSP STAINLESS 1670-15</p>
<p>METRIC 10.9 HEX HEAD CAP SCREWS</p>  <p>DIN 961 FULLY THREADED FINE THREAD BMH PLATED LINE - 1643 - 06 M8 THRU M24</p>	<p>STAINLESS A2 BRL 1670-23</p>	<p>METRIC THREADED ROD 1-METER DIN 975</p>  <p>BTC PLATED 4.6 1660-00 BTP B7-ALLOY 166-02 A2 BTN STAINLESS 1660-01</p>	<p>PHILLIPS FLAT HEAD DIN 965A</p>  <p>CMC PLATED 1666-00 BSR STAINLESS 1670-16</p>
<p>METRIC 10.9 HEX HEAD CAP SCREWS</p>  <p>DIN 961 FULLY THREADED FINE THREAD BMH PLATED LINE - 1643 - 06 M8 THRU M24</p>	<p>LOW SOCKET CAP SCREW</p>  <p>DIN 6912 CLASS 8.8 CEC PLAIN 1657-00 BTY STAINLESS 1672-23</p>	<p>METRIC THREADED ROD 1-METER DIN 975</p>  <p>BTC PLATED 4.6 1660-00 BTP B7-ALLOY 166-02 A2 BTN STAINLESS 1660-01</p>	<p>METRIC STUDS</p>  <p>M6 - M8 - M10 (MANIFOLD) JEY 8.8 DIN 939 LINE - 1672 - 01</p>

Brass Pipe Fittings

Used with: Brass, copper and iron pipe.

Advantages: Positive mechanical seal. Large range of styles and sizes available.

Typical Application: Could be used with water, air, oil, natural gas and liquefied petroleum products.

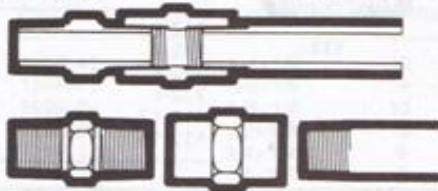

ACTUAL SIZE OF PIPE THREAD AT SMALL END

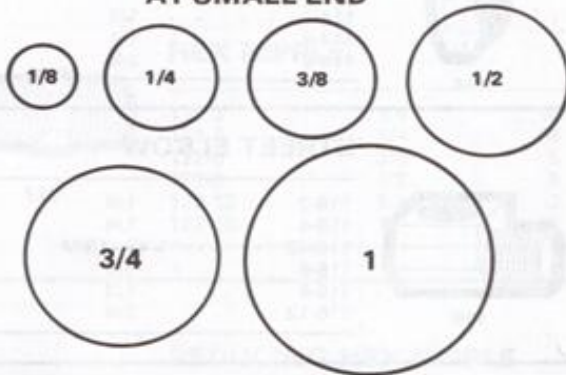

REDUCING COUPLING



10

Part No.	Pipe Thread	Std. Pckg. Quantity
10-42	1/4 x 1/8	5
10-62	3/8 x 1/8	5
10-64	3/8 x 1/4	5
10-82	1/2 x 1/8	5
10-84	1/2 x 1/4	2
10-86	1/2 x 3/8	5
10-122	3/4 x 1/8	2
10-124	3/4 x 1/4	2
10-126	3/4 x 3/8	2
10-128	3/4 x 1/2	2
10-168	1 x 1/2	2
10-1612	1 x 3/4	1

ELBOW



100

Part No.	Pipe Thread	Std. Pckg. Quantity
100-2	1/8	5
100-4	1/4	5
100-6	3/8	5
100-8	1/2	5
100-12	3/4	2

TEE

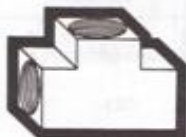

101

Part No.	Pipe Thread	Std. Pckg. Quantity
101-2	1/8	5
101-4	1/4	5
101-6	3/8	5
101-8	1/2	5
101-12	3/4	2



102

CROSS

Part No.	Pipe Thread	Std. Pckg. Quantity
102-2	1/8	5
102-4	1/4	5
102-6	3/8	5
102-8	1/2	5

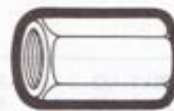

103

COUPLING

Part No.	Pipe Thread	Std. Pckg. Quantity
103-2	1/8	5
103-4	1/4	5
103-6	3/8	5
103-8	1/2	5
103-12	3/4	2
103-16	1	2



104

UNION

Part No.	Pipe Thread	Std. Pckg. Quantity
104-2	1/8	5
104-4	1/4	5
104-6	3/8	5
104-8	1/2	5
104-12	3/4	2



108

CAP

Part No.	Pipe Thread	Std. Pckg. Quantity
108-2	1/8	5
108-4	1/4	5
108-6	3/8	5
108-8	1/2	5
108-12	3/4	2



109

SQUARE HEAD PLUG

Part No.	Pipe Thread	Std. Pckg. Quantity
109-2	1/8	10
109-4	1/4	10
109-6	3/8	5
109-8	1/2	5
109-12	3/4	2
109-16	1	2



110

BUSHING

Part No.	Pipe Thread	Std. Pckg. Quantity
110-42	1/4 x 1/8	10
110-62	3/8 x 1/8	10
110-64	3/8 x 1/4	10
110-82	1/2 x 1/8	5
110-84	1/2 x 1/4	5
110-86	1/2 x 3/8	5
110-122	3/4 x 1/8	2
110-124	3/4 x 1/4	5
110-126	3/4 x 3/8	5
110-128	3/4 x 1/2	5
110-164	1 x 1/4	2
110-166	1 x 3/8	2
110-168	1 x 1/2	2
110-1612	1 x 3/4	2

Brass Pipe Fittings

LOCK NUT



111

Part No.	Pipe Thread	Std. Pckg. Quantity
111-2	1/8	10
111-4	1/4	10
111-6	3/8	5
111-8	1/2	5

LONG NIPPLE



113

113-215	1/8x1-1/2	5
113-415	1/4x1-1/2	5
113-615	3/8x1-1/2	5
113-815	1/2x1-1/2	5
113-1215	3/4x1-1/2	2
113-220	1/8x2	5
113-420	1/4x2	5
113-620	3/8x2	5
113-820	1/2x2	5
113-1220	3/4x2	2
113-225	1/8x2-1/2	5
113-425	1/4x2-1/2	5
113-625	3/8x2-1/2	5
113-825	1/2x2-1/2	2
113-1225	3/4x2-1/2	2
113-230	1/8x3	5
113-430	1/4x3	5
113-630	3/8x3	5
113-830	1/2x3	2
113-1230	3/4x3	2
113-235	1/8x3-1/2	5
113-435	1/4x3-1/2	5
113-635	3/8x3-1/2	2
113-835	1/2x3-1/2	2
113-1235	3/4x3-1/2	2
113-240	1/8x4	5
113-440	1/4x4	5
113-640	3/8x4	2
113-840	1/2x4	2
113-1240	3/4x4	2
113-245	1/8x4-1/2	5
113-445	1/4x4-1/2	5
113-645	3/8x4-1/2	2
113-845	1/2x4-1/2	2
113-1245	3/4x4-1/2	2
113-250	1/8x5	5
113-450	1/4x5	5
113-650	3/8x5	2
113-850	1/2x5	2
113-1250	3/4x5	2
113-255	1/8x5-1/2	2
113-455	1/4x5-1/2	2
113-655	3/8x5-1/2	2
113-855	1/2x5-1/2	2
113-1255	3/4x5-1/2	2
113-260	1/8x6	2
113-460	1/4x6	2
113-660	3/8x6	2
113-860	1/2x6	2
113-1260	3/4x6	2

CLOSE NIPPLE



112

Part No.	Pipe Thread	Std. Pckg. Quantity
112-2	1/8	10
112-4	1/4	10
112-6	3/8	5
112-8	1/2	5
112-12	3/4	2
112-16	1	2

PIPE FLANGE



114

114-2	1/8	5
114-4	1/4	5
114-6	3/8	5

STREET ELBOW

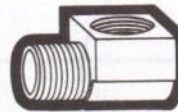

116

116-2	1/8	5
116-4	1/4	5
116-42	1/4Fx1/8M	5
116-6	3/8	5
116-8	1/2	5
116-12	3/4	2

PLUG - SLOTTED HEAD



117

117-2	1/8	10
117-4	1/4	10
117-6	3/8	5

PLUG - RECESSED HEX HEAD



118

118-2	1/8	10
118-4	1/4	10
118-6	3/8	5
118-8	1/2	5
118-12	3/4	2

ADAPTER



120

120-2	1/8	10
120-4	1/4	10
120-6	3/8	10
120-8	1/2	5
120-12	3/4	2

PLUG - HEX HEAD



121

121-2	1/8	10
121-4	1/4	10
121-6	3/8	5
121-8	1/2	5
121-12	3/4	2
121-16	1	2

Brass Pipe Fittings

REDUCING ADAPTER



120R

Part No.	Pipe Thread	Std. Pckg. Quantity
120R-42	1/4x1/8	10
120R-62	3/8x1/8	10
120R-64	3/8x1/4	10
120R-86	1/2x3/8	5
120R-128	3/4x1/2	5
120R-1612	1x3/4	2

SERVICE TEE – MALE PIPE ON RUN

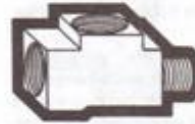

127

Part No.	Pipe Thread	Std. Pckg. Quantity
127-2	1/8FxMxF	5
127-4	1/4FxMxF	5
127-6	3/8FxMxF	5
127-8	1/2FxMxF	2

HEX NIPPLE



122

Part No.	Pipe Thread	Std. Pckg. Quantity
122-2	1/8	10
122-4	1/4	10
122-6	3/8	5
122-8	1/2	5
122-12	3/4	2
122-16	1	2

SERVICE TEE – MALE PIPE ON BRANCH



128

Part No.	Pipe Thread	Std. Pckg. Quantity
128-2	1/8FxFxM	5
128-4	1/4FxFxM	5
128-6	3/8FxFxM	5
128-8	1/2FxFxM	2

REDUCING HEX NIPPLE



123

Part No.	Pipe Thread	Std. Pckg. Quantity
123-42	1/4x1/8	5
123-62	3/8x1/8	5
123-64	3/8x1/4	5
123-84	1/2x1/4	2
123-86	1/2x3/8	5
123-128	3/4x1/2	2

45 DEGREE ELBOW



129

Part No.	Pipe Thread	Std. Pckg. Quantity
129-2	1/8	5
129-4	1/4	5

45 DEGREE STREET ELBOW



124

Part No.	Pipe Thread	Std. Pckg. Quantity
124-2	1/8	10
124-4	1/4	10
124-6	3/8	5
124-8	1/2	5
124-12	3/4	2

FUSEABLE PIPE PLUG



132

Part No.	Melting Point	Pipe Size	Std. Pckg. Quantity
132-165-2	165 Degrees	1/8	5
132-165-4	165 Degrees	1/4	5
132-165-6	165 Degrees	3/8	3
132-165-8	165 Degrees	1/2	3
132-212-2	212 Degrees	1/8	5
132-212-4	212 Degrees	1/4	5
132-212-6	212 Degrees	3/8	3
132-212-8	212 Degrees	1/2	3
132-280-2	280 Degrees	1/8	5
132-280-4	280 Degrees	1/4	5
132-280-6	280 Degrees	3/8	3
132-280-8	280 Degrees	1/2	3

MALE ELBOW



126

Part No.	Pipe Thread	Std. Pckg. Quantity
126-2	1/8	5
126-4	1/4	5
126-6	3/8	5
126-8	1/2	2
126-42	1/4x1/8	2
126-64	3/8x1/4	2
126-86	1/2x3/8	2

Reusable Air Brake Hose Ends

ASSEMBLY INSTRUCTIONS

1. Slide nut and sleeve onto hose. Make sure bevel edge of sleeve faces out toward fitting.
2. Push hose into fitting until it bottoms.
3. Tighten nut down all the way.

For use with 360 Hose

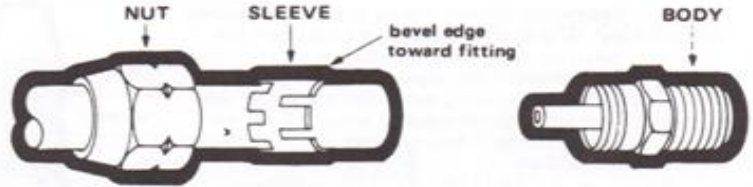

362

HOSE MENDER ASSEMBLY

Part No.	Hose I.D.	Pipe Thread	Std. Pkg. Quantity
362-6	3/8		2
362-8	1/2		2



367

SLEEVE

367-6	3/8	10
367-8	1/2	10



368

CONNECTOR ASSEMBLY

368-64	3/8	1/4	3
368-66	3/8	3/8	3
368-68	3/8	1/2	3
368-86	1/2	3/8	2
368-88	1/2	1/2	2



369

COUPLING NUT

369-6	3/8	10
369-8	1/2	5



370

COUPLING BODY ONLY

370-64	3/8	1/4	5
370-66	3/8	3/8	5
370-68	3/8	1/2	5
370-86	1/2	3/8	5
370-88	1/2	1/2	5



377

SPRING GUARD ONLY

377-6	3/8	5
-------	-----	---



378

CONNECTOR ASSEMBLY WITH SPRING GUARD

Part No.	Hose I.D.	Pipe Thread	Std. Pkg. Quantity
378-64	3/8	1/4	2
378-66	3/8	3/8	2
378-68	3/8	1/2	2
378-86	1/2	3/8	2
378-88	1/2	1/2	2



379

COUPLING NUT WITH SPRING GUARD

379-6	3/8	10
379-6L	3/8 (less spring)	10
379-8L	1/2 (less spring)	10



386

FEMALE CONNECTOR

	Thread Size		
386-6	3/8	3/4-20	2
386-8	1/2	7/8-20	2



387

CONNECTOR WITH ADAPTER

387-64	3/8	1/4	2
387-66	3/8	3/8	2
387-86	1/2	3/8	2

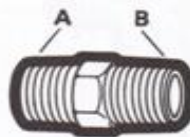

388

ADAPTER

	A Air Brake Swivel	A Thread Size	B Pipe Size	
388-64	3/8	3/4-20	1/4	2
388-66	3/8	3/4-20	3/8	2
388-86	1/2	7/8-20	3/8	2
388-88	1/2	7/8-20	1/2	2

Air Brake Copper Tube Compression

Used with: Copper tubing in air brake systems can be used with the #463 tube support for nylon air brake tube installations.

Advantages: Ball sleeve annealed to insure perfect seal. Long nut offers maximum tube support. Interchangeable with O.E.M. Air Brake fittings. Thread size for 3/8 O.D. fittings is 17/32-24.



ASSEMBLY INSTRUCTIONS

1. Slide nut and then sleeve on tubing. Threaded end of nut must face out.
2. Insert tubing into fitting body. Be sure tubing is bottomed on fitting shoulder.
3. Assemble nut to fitting body hand tight.
4. Tighten nut securely with a wrench. Two turns for small O.D. tube. Three turns maximum for larger tubes. This allows maximum reassemblies.



B162

UNION

Part No.	O.D. Tube	Pipe Thread	Std. Pckg. Quantity
B162-4	1/4		5
B162-6	3/8		5
B162-8	1/2		2
B162-10	5/8		2
B162-12	3/4		2

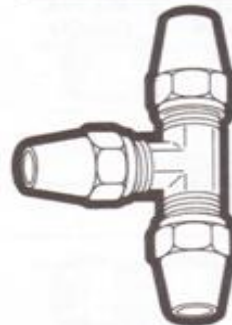

B164

TEE-THREE TUBE ENDS

B164-4	1/4		5
B164-68	3/8x3/8x1/2		2
B164-6	3/8		5
B164-8	1/2		2
B164-10	5/8		2
B164-12	3/4		2

SLEEVE



B60

Part No.	O.D. Tube	Pipe Thread	Std. Pckg. Quantity
B60-4	1/4		10
B60-6	3/8		10
B60-8	1/2		10
B60-10	5/8		5
B60-12	3/4		5

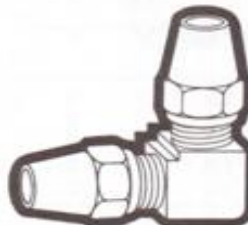

B165

ELBOW-TWO TUBE ENDS

B165-4	1/4		5
B165-6	3/8		5
B165-8	1/2		2
B165-10	5/8		2
B165-12	3/4		2

NUT



B161

B161-4	1/4		5
B161-6	3/8		10
B161-8	1/2		5
B161-10	5/8		5
B161-12	3/4		5

45 DEGREE MALE ELBOW



B177

B177-42	1/4	1/4	5
B177-62	3/8	1/8	5
B177-64	3/8	1/4	5
B177-66	3/8	3/8	5
B177-68	3/8	1/2	5
B177-86	1/2	3/8	2
B177-88	1/2	1/2	2
B177-108	5/8	1/2	2



B166

FEMALE CONNECTOR

B166-42	1/4	1/8	5
B166-44	1/4	1/4	5
B166-62	3/8	1/8	5
B166-64	3/8	1/4	5
B166-66	3/8	3/8	5
B166-84	1/2	1/4	5
B166-86	1/2	3/8	5
B166-88	1/2	1/2	5
B166-106	5/8	3/8	2
B166-108	5/8	1/2	2
B166-128	3/4	1/2	2
B166-1212	3/4	3/4	2

Air Brake Copper Tube Compression

MALE CONNECTOR



Part No.	O.D. Tube	Pipe Thread	Std. Pckg. Quantity
B168-42	1/4	1/8	10
B168-44	1/4	1/4	10
B168-46	1/4	3/8	5
B168-62	3/8	1/8	10
B168-64	3/8	1/4	10
B168-66	3/8	3/8	5
B168-68	3/8	1/2	5
B168-84	1/2	1/4	5
B168-86	1/2	3/8	5
B168-88	1/2	1/2	5
B168-106	5/8	3/8	2
B168-108	5/8	1/2	2
B168-1012	5/8	3/4	2
B168-128	3/4	1/2	2
B168-1212	3/4	3/4	2

TEE-PIPE ON RUN

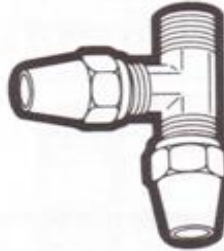

Part No.	O.D. Tube	Pipe Thread	Std. Pckg. Quantity
B171-42	1/4	1/8	5
B171-44	1/4	1/4	5
B171-62	3/8	1/8	5
B171-64	3/8	1/4	5
B171-66	3/8	3/8	5
B171-86	1/2	3/8	2
B171-88	1/2	1/2	2
B171-108	5/8	1/2	2
B171-128	3/4	1/2	2

MALE ELBOW

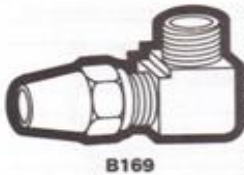

Part No.	O.D. Tube	Pipe Thread	Std. Pckg. Quantity
B169-42	1/4	1/8	10
B169-44	1/4	1/4	5
B169-46	1/4	3/8	5
B169-62	3/8	1/8	5
B169-62L	3/8	1/8	5
B169-64	3/8	1/4	10
B169-64L	3/8	1/4	5
B169-66	3/8	3/8	5
B169-68	3/8	1/2	5
B169-84	1/2	1/4	2
B169-86	1/2	3/8	2
B169-88	1/2	1/2	2
B169-106	5/8	3/8	2
B169-108	5/8	1/2	2
B169-1012	5/8	3/4	2
B169-128	3/4	1/2	2
B169-1212	3/4	3/4	2

TEE-PIPE ON BRANCH



Part No.	O.D. Tube	Pipe Thread	Std. Pckg. Quantity
B172-42	1/4	1/8	5
B172-44	1/4	1/4	5
B172-62	3/8	1/8	5
B172-64	3/8	1/4	5
B172-66	3/8	3/8	5
B172-86	1/2	3/8	2
B172-88	1/2	1/2	2
B172-108	5/8	1/2	2
B172-128	3/4	1/2	2

FEMALE ELBOW



Part No.	O.D. Tube	Pipe Thread	Std. Pckg. Quantity
B170-42	1/4	1/8	5
B170-44	1/4	1/4	5
B170-62	3/8	1/8	5
B170-64	3/8	1/4	5
B170-66	3/8	3/8	5
B170-86	1/2	3/8	2
B170-88	1/2	1/2	2
B170-108	5/8	1/2	2
B170-1012	5/8	3/4	2

SERVICE TEE-PIPE ON RUN



B176-64	3/8	1/4MxF	2
---------	-----	--------	---

SERVICE TEE-PIPE ON RUN



B179-64	3/8	1/4FPT run x1/4MPT drop	2
---------	-----	----------------------------	---

See air brake copper tube fittings assortment on page 11

Air Brake Fittings for Nylon Tubing

Used with: Nylon tubing (SAE J844, type 3).
Advantages: Meets all air brake specifications. Utilizes ribbed sleeve for compression and positive grip. Five remakes possible when disassembled. Body less insert interchangeable with standard air brake compression bodies. Special tools are not required.
Typical applications: Air brake systems, air control and gauge lines.

ASSEMBLY INSTRUCTIONS

1. Cut tubing to length required.
2. Insert tubing into fitting.
3. Tighten nut.

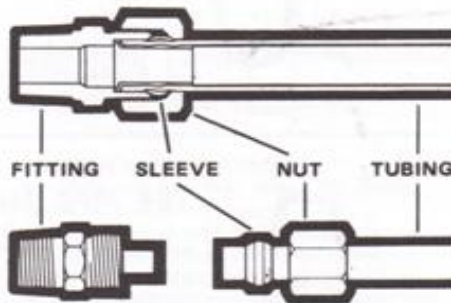

DISASSEMBLY INSTRUCTIONS
 Remove nut and pull tubing out of fitting body. Insert will remain in tubing.

RE-ASSEMBLY INSTRUCTIONS
 Push tubing and insert into fitting body until it bottoms. Thread nut onto fitting body and tighten.

TUBE SUPPORT



Part No.	O.D. Tube	Std.Pckg. Quantity
463-4	1/4	10
463-6	3/8	10
463-8	1/2	10
463-10	5/8	10
463-12	3/4	10

TEE-THREE TUBE ENDS



Part No.	O.D. Tube	Std.Pckg. Quantity
464-4	1/4	5
464-6	3/8	5
464-664	3/8x3/8x1/4	2
464-668	3/8x3/8x1/2	2
464-8	1/2	2
464-886	1/2x1/2x3/8	2
464-10	5/8	2

ELBOW-TWO TUBE ENDS



Part No.	O.D. Tube	Std.Pckg. Quantity
465-4	1/4	5
465-6	3/8	5
465-8	1/2	2
465-10	5/8	2

FEMALE CONNECTOR



Part No.	Pipe Thread		Std.Pckg. Quantity
	Male	Female	
466-42	1/4	1/8	5
466-44	1/4	1/4	5
466-62	3/8	1/8	5
466-64	3/8	1/4	5
466-66	3/8	3/8	5
466-86	1/2	3/8	5
466-88	1/2	1/2	5
466-106	5/8	3/8	2
466-108	5/8	1/2	2
466-128	3/4	1/2	2

SLEEVE



Part No.	O.D. Tube	Std.Pckg. Quantity
460-4	1/4	10
460-6	3/8	10
460-8	1/2	10
460-10	5/8	5
460-12	3/4	5

NUT



Part No.	O.D. Tube	Std.Pckg. Quantity
461-4	1/4	5
461-6	3/8	10
461-8	1/2	5
461-10	5/8	5
461-12	3/4	5

UNION



Part No.	O.D. Tube	Std.Pckg. Quantity
462-4	1/4	5
462-6	3/8	5
462-8	1/2	2
462-10	5/8	2
462-12	3/4	2

MALE CONNECTOR



Part No.	Pipe Thread		Std.Pckg. Quantity
	Male	Female	
468-42	1/4	1/8	10
468-44	1/4	1/4	10
468-46	1/4	3/8	5
468-62	3/8	1/8	10
468-64	3/8	1/4	10
468-66	3/8	3/8	5
468-68	3/8	1/2	5
468-84	1/2	1/4	5
468-86	1/2	3/8	5
468-88	1/2	1/2	5
468-812	1/2	3/4	2
468-106	5/8	3/8	2
468-108	5/8	1/2	2
468-1012	5/8	3/4	2
468-128	3/4	1/2	2
468-1212	3/4	3/4	2

Air Brake Fittings for Nylon Tubing

MALE ELBOW



469

Part No.	O.D. Tube	Pipe Thread	Std. Pckg. Quantity
469-42	1/4	1/8	10
469-44	1/4	1/4	5
469-46	1/4	3/8	5
469-62	3/8	1/8	10
469-62L	3/8	1/8 long	5
469-64	3/8	1/4	10
469-66	3/8	3/8	5
469-68	3/8	1/2	5
469-84	1/2	1/4	2
469-86	1/2	3/8	2
469-88	1/2	1/2	2
469-106	5/8	3/8	2
469-108	5/8	1/2	2
469-1012	5/8	3/4	2
469-126	3/4	3/8	2
469-128	3/4	1/2	2
469-1212	3/4	3/4	2

BULKHEAD UNION



475

Part No.	O.D. Tube	Pipe Thread	Std. Pckg. Quantity
475-4	1/4		5
475-6	3/8		5
475-8	1/2		2
475-10	5/8		2

TEE-FEMALE PIPE BRANCH



477

Part No.	O.D. Tube	Pipe Thread	Std. Pckg. Quantity
477-64	3/8	1/4	5
477-84	1/2	1/4	2

FEMALE ELBOW



470

Part No.	O.D. Tube	Pipe Thread	Std. Pckg. Quantity
470-42	1/4	1/8	5
470-44	1/4	1/4	5
470-62	3/8	1/8	5
470-64	3/8	1/4	5
470-66	3/8	3/8	5
470-86	1/2	3/8	2
470-88	1/2	1/2	2
470-108	5/8	1/2	2

45 DEGREE MALE ELBOW



480

Part No.	O.D. Tube	Pipe Thread	Std. Pckg. Quantity
480-42	1/4	1/8	10
480-44	1/4	1/4	5
480-62	3/8	1/8	5
480-64	3/8	1/4	10
480-66	3/8	3/8	5
480-68	3/8	1/2	5
480-84	1/2	1/4	2
480-86	1/2	3/8	2
480-88	1/2	1/2	2
480-108	5/8	1/2	2

TEE-PIPE ON RUN

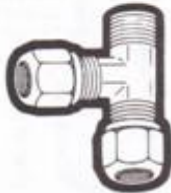

471

Part No.	O.D. Tube	Pipe Thread	Std. Pckg. Quantity
471-42	1/4	1/8	5
471-44	1/4	1/4	5
471-64	3/8	1/4	5
471-66	3/8	3/8	5
471-86	1/2	3/8	2
471-88	1/2	1/2	2
471-108	5/8	1/2	2

SERVICE TEE



482

Part No.	O.D. Tube	Pipe Thread FxM	Std. Pckg. Quantity
482-644	3/8	1/4 x 1/4	2
482-646	3/8	1/4 x 3/8	2

TEE-PIPE ON BRANCH



472

Part No.	O.D. Tube	Pipe Thread	Std. Pckg. Quantity
472-42	1/4	1/8	5
472-44	1/4	1/4	5
472-62	3/8	1/8	5
472-64	3/8	1/4	5
472-66	3/8	3/8	5
472-86	1/2	3/8	2
472-88	1/2	1/2	2
472-108	5/8	1/2	2

TEE



483

Part No.	O.D. Tube	Pipe Thread	Std. Pckg. Quantity
483-664	3/8	3/8 x 1/4	2

Push-To-Connect Air Brake Fittings

HOW TO USE THE CORONET PUSH-TO-CONNECT AIR BRAKE FITTING:



TO CONNECT TUBE:

Cut Plastic tube as squarely as possible. Insert tube end into fitting, sliding the I.D. of the tube over the tube support until friction is felt as tube slides past the O-ring. Using a slight twisting motion while inserting the tube is often helpful. After this initial friction is felt, continue to push in the tube until it bottoms firmly against the internal tube support.



TO DISCONNECT TUBE:

With thumb and forefinger, hold down the top of the insert against the fitting body and then, with the other hand, pull out the tubing. No tools are needed.

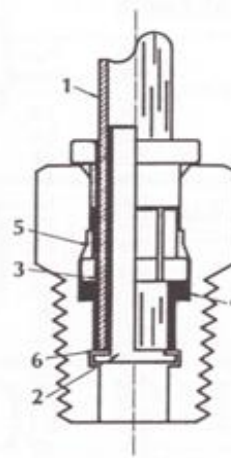

When tubing (1) is inserted into the fitting the inside diameter passes over the brass tube support (2). This, combined with the action of the gripper, insured that the air brake hose assembly with safely exceed the tensile requirements of FMVSS-106 for applications described in this catalog. The tubing then passes through the gripping teeth (3). The tubing continues beyond the gripping teeth through the inside diameter of the lubricated "O" ring (4) which seals on the outside diameter of the tubing. The gripping teeth grab the tube. Pulling back on the tube only tightens the grip on the tubing as the insert moves onto the camming surface (5). Pressure through the tube also serves to tighten the grip. The tube bottoms against a positive tube stop (6) in a cavity providing tube support to prevent leakage.

DESIGN FEATURES:

- DOT marked and approved (see below).
- **QUICK CONNECT**, simply push tubing in, no tools, or loose parts to handle in tight places.
- **FULL FLOW DESIGN**, Provides up to 60% more flow area than conventional fittings with internal tube supports.
- **BRASS CONSTRUCTION**, Elbows and tees are forged brass.
- **SWIVEL** elbows and tees for ease of orientation.

Series AQ-DOT Fittings are designed for use in applications described in **bold type** in the excerpt below from the National Highway Traffic Safety Administration, Department Of Transportation FMVSS-106.

S7.3.10 Tensile Strength: An air brake hose assembly (other than a coiled nylon tube assembly which meets the requirements of S393.45 of this title) designed for use between frame and axle or between a towed and towing vehicle shall withstand, without separation of the hose from its end fittings, a pull of 250 pounds if it is 1/4 inch or less in nominal internal diameter, or a pull of 325 pounds if it is larger than 1/4 inch nominal internal diameter. **An air brake assembly designed for use with any other application shall withstand without separation of the hose from its end fitting, a pull of 50 pounds if it is 1/4 inch or less in internal diameter, 150 pounds if it is 3/8 or 1/2 inch in nominal internal diameter, or 325 pounds if it is larger than 1/2 inch in nominal internal diameter.** (S8.9) (39F.R. 28436 - Aug. 7, 1974. Effective 3/1/75).



UNION

Part No.	O.D. Tube	Pipe Thread	Std. Pckg. Quantity
962-4	1/4		5
962-6	3/8		5
962-8	1/2		5

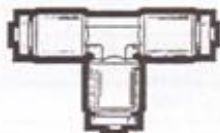

UNION TEE

964-4	1/4		5
964-6	3/8		5
964-8	1/2		5



UNION ELBOW

965-4	1/4		5
965-6	3/8		5
965-8	1/2		5



FEMALE CONNECTOR

966-42	1/4	1/8	5
966-44	1/4	1/4	5
966-64	3/8	1/4	5
966-66	3/8	3/8	5

MALE CONNECTOR

Part No.	O.D. Tube	Pipe Thread	Std. Pckg. Quantity
968-42	1/4	1/8	5
968-44	1/4	1/4	5
968-46	1/4	3/8	5
968-62	3/8	1/8	5
968-64	3/8	1/4	5
968-66	3/8	3/8	5
968-68	3/8	1/2	5
968-84	1/2	1/4	5
968-86	1/2	3/8	5
968-88	1/2	1/2	5



MALE ELBOW

969-42	1/4	1/8	5
969-44	1/4	1/4	5
969-46	1/4	3/8	5
969-64	3/8	1/4	5
969-66	3/8	3/8	5
969-86	1/2	3/8	5
969-88	1/2	1/2	5

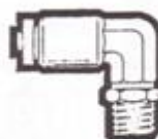

Push-To-Connect Airbrake Fittings

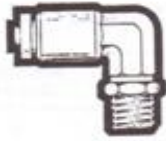

SWIVEL MALE ELBOW

Part No.	O.D. Tube	Pipe Thread	Std. Pckg. Quantity
969-1-42	1/4	1/8	5
969-1-44	1/4	1/4	5
969-1-46	1/4	3/8	5
969-1-62	3/8	1/8	5
969-1-64	3/8	1/4	5
969-1-66	3/8	3/8	5
969-1-68	3/8	1/2	5
969-1-86	1/2	3/8	5
969-1-88	1/2	1/2	5



BULKHEAD UNION

Part No.	O.D. Tube	Male Thread	Std. Pckg. Quantity
975-48	1/4	1/2-20	2
975-610	3/8	5/8-18	2
975-812	1/2	3/4-16	2

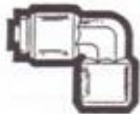

FEMALE ELBOW

Part No.	O.D. Tube	Pipe Thread	Std. Pckg. Quantity
970-42	1/4	1/8	5
970-44	1/4	1/4	5
970-64	3/8	1/4	5
970-66	3/8	3/8	5

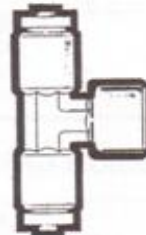

SWIVEL FEMALE BRANCH TEE

Part No.	O.D. Tube	Male Thread	Std. Pckg. Quantity
977-1-42	1/4	1/8	5
977-1-44	1/4	1/4	5
977-1-64	3/8	1/4	5

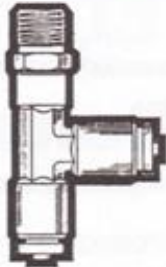

SWIVEL MALE RUN TEE

Part No.	O.D. Tube	Pipe Thread	Std. Pckg. Quantity
971-1-42	1/4	1/8	5
971-1-44	1/4	1/4	5
971-1-64	3/8	1/4	5
971-1-66	3/8	3/8	5
971-1-86	1/2	3/8	5



SWIVEL 45 DEGREE MALE ELBOW

Part No.	O.D. Tube	Pipe Thread	Std. Pckg. Quantity
980-1-42	1/4	1/8	5
980-1-44	1/4	1/4	5
980-1-64	3/8	1/4	5

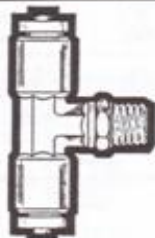

SWIVEL MALE BRANCH TEE

Part No.	O.D. Tube	Pipe Thread	Std. Pckg. Quantity
972-1-42	1/4	1/8	5
972-1-44	1/4	1/4	5
972-1-64	3/8	1/4	5
972-1-66	3/8	3/8	5
972-1-86	1/2	3/8	5



FEMALE BULKHEAD UNION

Part No.	O.D. Tube	Female Thread	Std. Pckg. Quantity
986-42	1/4	1/8	5
986-44	1/4	1/4	2
986-64	3/8	1/4	2

See nylon air brake tubing on pages 48, 64

Brass Ball Valves

Working Pressure – 600 PSI
Full port
Quarter turn for on-off

Part No.	Pipe Thread	Std. Pckg. Quantity
595-4	1/4	3
595-6	3/8	3
595-8	1/2	2
595-12	3/4	2
595-16	1	1

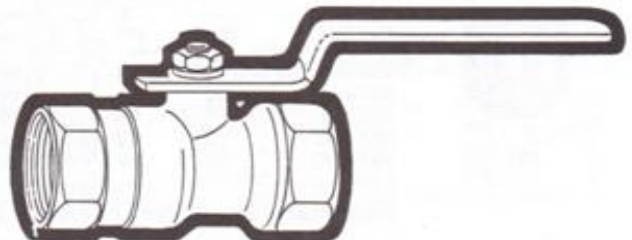

Collet Compression Fittings



560

COLLET (Slotted Ferrule)

Part No.	O.D. Tube	Std. Pckg. Quantity
560-2	1/8	10
560-2.5	5/32	10
560-4	1/4	10



568

COLLET MALE CONNECTOR

Part No.	O.D. Tube	Pipe Thread	Std. Pckg. Quantity
568-2.51	5/32	1/16	5
568-2.52	5/32	1/8	5
568-21	1/8	1/16	5
568-22	1/8	1/8	5
568-42	1/4	1/8	5



561

COLLET COMPRESSION NUT

Part No.	O.D. Tube	Std. Pckg. Quantity
561-2	1/8	10
561-2.5	5/32	10
561-4	1/4	10



562

COLLET COMPRESSION UNION

Part No.	O.D. Tube	Std. Pckg. Quantity
562-2	1/8	5
562-2.5	5/32	5
562-4	1/4	5



569

COLLET MALE ELBOW

Part No.	O.D. Tube	Pipe Thread	Std. Pckg. Quantity
569-2.52	5/32	1/8	5
569-21	1/8	1/16	5
569-22	1/8	1/8	5
569-42	1/4	1/8	5

See air brake nylon tubing for 5/32 collet fittings on pages 48, 64

Frame Couplings and Terminal Bolts



380

BULKHEAD COUPLING

Part No.	Pipe Thread		Length (Inches)
	Male	Female	
380-84S	1/2	1/4	2-15/16
380-84L	1/2	1/4	3-15/16
380-84M*	1/2	1/4	2-7/8

*comes with large mounting nut

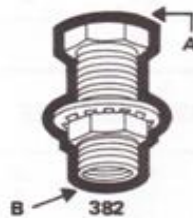

382

BULKHEAD COUPLING

Part No.	Pipe Thread		Length (Inches)
	FPT	FPT	
382-44S	1/4	1/4	15/16
382-44L	1/4	1/4	1-1/2
382-66	3/8	3/8	1-15/16



381

BULKHEAD COUPLING

Part No.	Pipe Thread		Length (Inches)
	MPT	FPT	
381-84	1/2	1/4	2-1/8
381-84S	1/2	1/4	2-1/8
381-84L	1/2	1/4	2-1/2
381-86L	1/2	3/8	1-29/32
381-86S	1/2	3/8	1-11/16

Standard Package Quantity 2



391

FRAME COUPLING

Part No.	O.D. Tube	Female Pipe	Length (Inches)
	A	B	
391-66	3/8	3/8	1-3/8
391-86	1/2	3/8	1-5/16



392

FRAME COUPLING

Part No.	O.D. Tube	Female Pipe	Length (Inches)
392-84	1/2	1/4	1-11/16

Air Brake Hose Assemblies

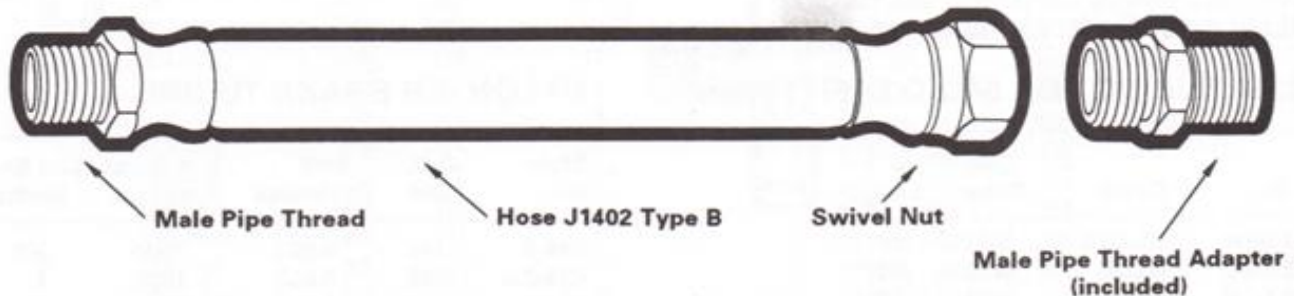

NOTE: ALL AIR BRAKE HOSE ASSEMBLIES COME WITH ONE FIXED MALE END, AND ONE FEMALE SWIVEL END, AND WITH ADAPTER FITTING.

LENGTH (inches)	264 SERIES (3/8 I.D. Hose x 1/4 Male Pipe)	266 SERIES (3/8 I.D. Hose x 3/8 Male Pipe)	286 SERIES (1/2 I.D. Hose x 3/8 Male Pipe)
12	26412	-	-
14	26414	26614	28614
18	26418	26618	28618
20	26420	26620	28620
22	26422	26622	28622
24	26424	26624	28624
26	26426	26626	28626
28	26428	26628	28628
30	26430	26630	28630
32	26432	26632	28632
34	26434	26634	28634
36	26436	26636	28636
38	26438	26638	28638
40	26440	26640	28640
42	26442	26642	28642
44	26444	26644	28644
46	26446	26646	28646
48	26448	26648	28648
54	26454	26654	28654
60	26460	26660	28660
68	-	-	28668
72	26472	26672	28672

Standard Package: 1 Piece

Nylon Air Brake Tubing

DESIGNED FOR AIR BRAKE SYSTEMS, AIR CONTROL AND GAUGE LINES
 TUBING CONFORMS TO SAE J844 (type 3A-non reinforced & type 3B-reinforced)
 OPERATING TEMPERATURES OF -40 F TO + 200 F
 MEETS D.O.T. FMVSS 106 (except size 1/8 O.D.)
 AVAILABLE IN A VARIETY OF LENGTHS AND COLORS

NYLON TUBING FOR 5/32 O.D. FITTINGS

Part No.	Color	O.D. Tube	Length
635-2.5BK	BLACK	5/32	50'
635-2.5BL	BLUE	5/32	50'
635-2.5GN	GREEN	5/23	50'
635-2.5RD	RED	5/32	50'
635-2.5RN	ORANGE	5/32	50'
635-2.5YW	YELLOW	5/32	50'

NYLON AIR BRAKE TUBING

Style No.	O.D. Tube	Wall Thickness	Min Burst Pressure	Min Bend Radius
634-2	1/8	0.023	1000	3/8
634-2.5	5/32	0.032	1000	1
634-3	3/16	0.035	1000	1
634-4	1/4	0.040	1200	1
634-5	5/16	0.040	1000	1-1/4
634-6	3/8	0.062	1400	1-1/2
634-8	1/2	0.062	950	2
634-10	5/8	0.092	900	2 1/2
634-12	3/4	0.092	800	3

NEW NYLON AIR BRAKE TUBING PART NUMBERS

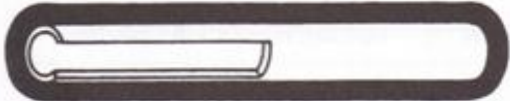

SAE J844 TYPE 3A
 Single Wall Extruded Nylon
 (1/8, 5/32, 3/16, 1/4, 5/16 size)

TYPE 3A

Part No.	O.D. Tube	Length Each	Color
634-2-BK-100	1/8	100'	BLACK
634-2.5-BK-100	5/32	100'	BLACK
634-3-BK-100	3/16	100'	BLACK
634-4-BK-100	1/4	100'	BLACK
634-4-BL-100	1/4	100'	BLUE
634-4-RD-100	1/4	100'	RED
634-4-BK-1000	1/4	1000'	BLACK
634-4-BL-1000	1/4	1000'	BLUE
634-4-RD-1000	1/4	1000'	RED
634-5-BK-100	5/16	100'	BLACK

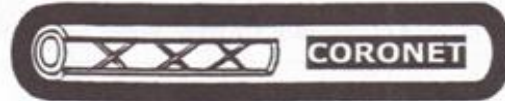

SAE J844 TYPE 3B
 Extruded Nylon Inner Tube with one open ply of fibrous reinforcement and a protective nylon sheath.
 (3/8, 1/2, 5/8, 3/4 size)

TYPE 3B

Part No.	O.D. Tube	Length Each	Color
634-6-BK-100	3/8	100'	BLACK
634-6-BL-100	3/8	100'	BLUE
634-6-RD-100	3/8	100'	RED
634-6-BK-500	3/8	500'	BLACK
634-6-BL-500	3/8	500'	BLUE
634-6-RD-500	3/8	500'	RED
634-8-BK-100	1/2	100'	BLACK
634-8-BL-100	1/2	100'	BLUE
634-8-RD-100	1/2	100'	RED
634-8-BK-500	1/2	500'	BLACK
634-8-BL-500	1/2	500'	BLUE
634-8-RD-500	1/2	500'	RED
634-10-BK-50	5/8	50'	BLACK
634-10-BK-100	5/8	100'	BLACK
634-10-BK-250	5/8	250'	BLACK
634-12-BK-50	3/4	50'	BLACK
634-12-BK-100	3/4	100'	BLACK
634-12-BK-250	3/4	250'	BLACK

Truck Valves



836

HEAVY DUTY PLUG TYPE DRAIN COCK

Part No.	Description	Std. Pckg. Quantity
836-4	1/4" male pipe thread interchanges with B.W. No. 215310/103385	2



883

FLARE TO MALE PIPE

Part No.	O.D. Tube	Pipe Thread	Std. Pckg. Quantity
883-66	3/8	3/8	2
883-68	3/8	1/2	2
883-86	1/2	3/8	2
883-88	1/2	1/2	2
883-108	5/8	1/2	2



881

HOSE TO MALE PIPE

	Hose Size	Pipe Thread	Std. Pckg. Quantity
881-66	3/8	3/8	2
881-106	5/8	3/8	2
881-108	5/8	1/2	2
881-126	3/4	3/8	2
881-128	3/4	1/2	2



886

COMPRESSION TO NTA MALE PIPE

886-88	1/2	1/2	2
--------	-----	-----	---



882

FEMALE PIPE TO MALE PIPE

882-66	3/8	3/8	2
882-68	3/8	1/2	2
882-88	1/2	1/2	2



887

MALE PIPE TO FLARE

887-88	1/2	1/2	2
887-108	5/8	1/2	2



884

AIR TANK DRAIN VALVE

884-4	1/4	1
-------	-----	---



889

NTA MALE PIPE TO COMPRESSION

889-88	1/2	1/2	2
--------	-----	-----	---

3 & 4 Way Gas Tank Selector Shut-Off Cocks

All 3 & 4-way valves constructed with a brass body and Delrin plug. Mounting bracket cast into body.



894

HANDLE AND SCREW FOR 3 AND 4 WAY VALVES

Part No.	Pipe Thread	Handle Length	Std.Pckg. Quantity
894			5

FEMALE PIPE – 4 ENDS

Part No.	Pipe Thread	Handle Length	Std.Pckg. Quantity
896-4	1/4	flush	1
896-415	1/4	1-1/2	1
896-430	1/4	3	1
896-6	3/8	flush	1
896-615	3/8	1-1/2	1
896-630	3/8	3	1



895

FEMALE PIPE – 3 ENDS

895-4	1/4	flush	1
895-6	3/8	flush	1

Available with click on application. (e.g., 895-4C)

3-WAY VALVE



896

4-WAY VALVE

Available with click on application. (e.g., 896-4C)

Air Brake Coil Kits (Tractor Trailers)



Coronet's air brake kits are preassembled. Everything needed is included, no cutting or assembly required. Each kit consists of a red and blue tube assembly.

Specifications: Meets D.O.T. specifications for coiled nylon brake tubing and conforms to SAE tubing standard J844C, type 3B. Assembly fitted with brass 1/2-14 male couplings complete with plated steel spring guards.

Application: Used between tractor and trailer for service and emergency hookup.

How to Determine Maximum Working Length: The length needed is determined by positioning the tractor and trailer in an extreme right or left turn position. Measure the distance to the nearest foot and order the next size available. For tractors that pull various types of trailers, length ordered should be based on the longest installation.

Part No.	Fitting	Extended Hose Length	Std. Pckg. Quantity
390-812	1/2 MPT	12 ft.	1
390-815	1/2 MPT	15 ft.	1
390-820	1/2 MPT	20 ft.	1

Use Coronet Adapter Number 120R-86 to convert end fitting from 1/2 to 3/8 MPT.

Brass Brake Bolt Assemblies

BRASS BOLTS – PLATED NUT

Brake blocks stay tight. Block and shoe are held securely without play. Bolts are reusable on new brake lining installations.



186

BOLT STYLE – USS SERIES

Part No.	Thread Size	Length (Inches)	Std. Pckg. Quantity
186-100	3/8-16	1	10
186-125	3/8-16	1-1/4	10
186-150	3/8-16	1-1/2	10

Assemblies include hex steel nut and lockwasher.



184-185

RIVET REPLACEMENT

Part No.	Thread Size	Rivet No.	Std. Pckg. Quantity
184-3	3/16-24USS	#8	10
184-4	1/4-20USS	#10	10
185-3	3/16-32SAE	#8	10
185-4	1/4-28SAE	#10	10

Assemblies include hex steel nut, flat washer and lock washer. All Assemblies are 1" long.



187

BOLT STYLE – SAE SERIES

Part No.	Thread Size	Length (Inches)	Std. Pckg. Quantity
187-100	3/8-24	1	10
187-125	3/8-24	1-1/4	10
187-150	3/8-24	1-1/2	10

Assemblies include hex steel nut and lockwasher.

Gladhand Couplings

Die cast aluminum body - connects to 1/2" pipe.

Part No.	Type	Std. Pckg. Quantity
383-8	service connect only to service	1
384-8	emergency connect only to emergency	1
385-8	universal connects to all three styles	1

GLADHAND COUPLINGS



383-384-385

GLADHAND SEAL

Part No.	Std. Pckg. Quantity
386 Single Lip	10
389 Double Lip	10



386



389

Air Brake Diaphragms

Part #
TYPE-20
TYPE-24
TYPE-30

Air Brake Governor (D-2)

Part #	Description
AV-1	Air Brake Governor 100-120 P.S.I., includes (4) 1/8" 27 pipe plugs and mfg. gasket

Air Brake Hose

Part #	Description
482106498	3/8" x 250 Feet

Brake Hardware Kits

Part #	Batco #	BWP #	Euclid #	Midland #	Nuturn #
Sirco #					
QK-1	08-1088	M-K39	E2769	66861A	K-70
QK-1HD	08-1132	M-K39	E2769SHD	66867A	K-128

Air Brake Winter Chemicals

Part #	Description
12842	Air Brake Conditioner & Antifreeze 32 oz. Btl.
5601	Air Brake Conditioner & Antifreeze 1 Gal Btl.

Spring Brake Units

Part #	Description
3030	30/30 Combination Service

Service Chambers

Part #	Description
24SC	Type 24 Service Chamber
30SC	Type 30 Service Chamber

Battery Cable – Sold by 100 ft. Spool

Part #	Gauge
602000-01	2/0

Trailer Cable – Sold by 100 ft. Spool

Part #	Description
551400	4 Way, 14 Gauge
551500	6 Way, 14 Gauge
554500	7 Way, 6-14 Gauge 1-12 Gauge
551100	7 Way, 6-12 Gauge 1-10 Gauge

Air Seat Blow Gun Kit

Part #	Description
63050	Air Seat Blow Gun Kit

Clevis Pin Assembly

Part #	Description
10026A	5/8"-18 UNFx1/2" Pin Clevis Assembly

Back-Up Alarms

Evacuator Plus

Back-up Alarms with piezo-electric output circuit. Bracket and installation hardware included.

Part #	Description	Sound Level	Voltage
210331	Evacuator Plus	97 dB	12-48 VDC
210333	Evacuator Plus	107dB	12-48 VDC
210335	Evacuator Plus	112 dB	12-48 VDC
MS90	Back up Alarm	90 dB	12 VDC
510	Back up Alarm	97 dB	12 VDC

Coiled Electrics

Part #	Description	Working Length	Plug Style
47112	1-12 ga. & 6-14 ga.	12 ft	Angle-Straight
47115	1-12 ga. & 6-14 ga.	15 ft	Angle Straight
7ATG522MG	15' Green ABS Cable ABS Systems	4-12ga,2-10ga & 1-8 ga for	
45112	1-10 ga. & 6-12 ga.	12 ft	Angle-Straight

Coiled Air Sets

Part #	Description
55100	12' Coiled Air Set
55101	15' Coiled Air Set

Conspicuity Tape

Part #	Description
R81301	Ultra Reflective Safety Tape DOT Certified, meets all NHTSA Standards 2"x 150' Roll- 7" White/11" Red Alternating Pattern

Fans Complete with Mounting Hardware

Part #	Description
30054	Heavy Duty – Variable Speed, 12 Volt

Flap Holders

Part #	Description
B35	Flap Holder

Heavy Duty Electronic Flashers

Part #	Description
EF32 (EL12)	2 Prong 12 Volt
EF33 (EL13)	3 Prong 12 Volt
EP34	3 Prong 12 Volt Ideal # 768 Wagner #7058

Field Repair Kits

Part #	Description
31402	Two 3/8" NPTF Fittings

Aluminum Gladhands

Part #	Description
36101	Service
36201	Emergency
36301	Universal
1011G	Gladhand Grips – Pair

Gladhand Seals Sold in Bags of 10

Part #	Description
36001	Double Lip Seal
36011	Urethane Double Lip Seal, Blue
36012	Urethane Double Lip Seal, Red

Hose Tender Kits

Part #	Description
9420-1	16" Hose Tender Kit
9421-1	25" Hose Tender Kit

Hub Caps

Part #	Description
DG-6P	Dual Guard Hub Cap Stemco # - 340-4009
DG-5/6P	Dual Guard Hub Cap Stemco # - 340-4013

Ratchet & Lever Load Binders



Part #	Description
B02026	Ratchet Load Binder 5/16" G7, 3/8" G4 5,400 WLL
C01026	Lever Load Binder 5/16" G7, 3/8" G4 5,400 WLL

Open Road Truck Mirrors By CHAM-CAL

Part #	Description
20100	7"x16" Aluminum-5/16" Center Stud Mount

Slack Adjusters

Part #	Midland Sirco #	Grau #	Cam Diameter	Spline	Hole Setting
S2010A	KN47001		1_1/2"	10	5-6-7
S2011A	KN44051		1_1/2"	28	5-6
S2019A	KN44061		1_1/2"	28	5_1/2-6_1/2
S2020A	KN47011		1_1/2"	10	5_1/2-6_1/2
S2022A	---		1_1/2"	28	5-6-7

Switches/Sockets/Valves

Part #	Description
14020	Stop Light 2 Studs 1/4" - 18 NPTF
1111-60	Drain Valve w/5' Cable Preassembled

Quick Release Valves

Part #	Description
51102	1/2" x 3/8" x 3/8", 0 PSI Crack
51103	3/8" x 3/8" x 3/8", 0 PSI Crack

Electrical – Switches

Part #	Description
34-212P	Toggle Switch, 50 Amps/6-24V Systems 2 Positions (on-off), 2 Screw Terminal
35-306P	Push Pull Switch, Extra Heavy Duty, 75 Amps/6-28, 2 Positions
51-302P	Master Disconnect Switch, Lever Operated, 6-36V, 180 Amps, 3/8" Stud Terminals

Trailer Connectors

Part #	Description
11-604P (15-630D)	6 Pole H.D., Zinc Die-Cast Plug, 12-24 V, 35 Amp
11-609P (15-600D)	6 Pole H.D., Zinc Die-Cast Socket w/Concealed Terminals
11-702P (15-730D)	7 Pole H.D., Zinc Die-Cast Plug w/Cable Guard, 6-28 Volts, 40 Amp
11-720P (15-720D)	7 Pole H.D., Zinc Die-Cast Socket, 2 Hole Mount

Trailer Lighting



Strobes

Part #	Description
220100-02	Strobe, 12-72VDC, 2 Joule Firebolt, Amber
220200-02	Strobe, 12-72VDC, 2 Joule Firebolt Plus, with replaceable flash tube, Amber
211680-02 (220400-02)	Strobe, 12-48VDC, 8 Joule, Double Flash, 4" low profile, Pulsator 451, Amber
211694-02	Strobe, Pulsator 551 12-24VDC, 8 Joule, Amber Permanent Mount
462121-02	Renegade Strobe, 12-48VDC, 2.2 Joule, Double Flash, For Forklifts, Industrial Equipment
448112-02	Sentry Halogen Rotator 12VDC Amber Permanent Mount

Auxiliary Warning Lights

Part #	Description
415010-02	Turbo Beam Light Bar, 15" flush base x 5" high, 12VDC, with two 50 watt Halogen bulbs & 360degree rotator assembly, Amber
450112-02	Highlighter Mini Light Bar 12/24VDC 55 watt Halogen Bulb, Permanent Mount
452142-02	Highlighter Mini Light Bar 12/24VDC 55 watt Halogen Bulb, Magnetic Mount
453202-02	Highlighter Strobe 12VDC Amber Magnetic Mount

Truck & Trailer Lights

Part #	Description	Truck Lite #	Peterson #	Grote #
430W	License Illum.	26331	438	60101
431W	License Illum.	26330	435	60151
1010	Sealed Lamp-Red	1020R	142R	45812
1010-A	Sealed Lamp-Amber	10202Y	142A	45813
1011	Sealed Lamp w/Reflector-Red	10205R	143R	45832
1011-A	Sealed Lamp w/Reflector-Amber	10205Y	143A	45833
1030	Sealed Lamp 2"-Red	30200R	146R	45822
1030-A	Sealed Lamp 2"-Amber	30200Y	146A	45823
1203	Clearance Marker-Red	26303R	139R	46782
1203-A	Clearance Marker-Amber	26303Y	139A	46783
1211	Clearance Marker-Red	26302R	138R	46792
1211-A	Clearance Marker-Amber	26302Y	138A	46793
1259	Marker Light-Red	26301R	135R	45262
1259-A	Marker Light-Amber	26301Y	135A	45263
4054	Lamp Kit 4" - Red	40002R	426KR	52782
4064	Sealed S/T/T 4" - Red	40202R	426R	52772
4064-A	Sealed S/T/T 4" - Amber	40202Y	426A	52773
4212	Steel Blk S/T/T- Red	80334R	413	50232
9007	Lens 1200 Series-Red	99053R	138-15R	91962
9007-A	Lens 1200 Series-Amber	99053Y	138-15A	91963
9122	Plug for #1010, 1022, & 1030	94924	142-49	67050
9124	Double Contact Harness	94939	431-491	67000
9127	Rubber Grommet 4"	40700	426-18	91740
620W	Rubber Lamp 4"	80362	508	64931
4027	Universal S/T/T-3 Studs	80333R	445	50972
4029	Universal S/T/T-2 Studs	---	454W	50852



Crimp 'N Seal®

Waterproof Heat Shrink Connectors

FTZ Industries manufactures the most comprehensive and highest quality line of Crimp 'N Seal® heat shrinkable connectors on the market today. The company that first brought you heat shrinkable connectors over two decades ago has more than tripled the number of connectors available. Do not be fooled by imitations. No matter how it's spelled, if it does not say Crimp 'N Seal® it's not the original.

- **Seamless Tubular Splices** insures mechanical and electrical integrity under severe conditions and can be crimped on any side
- **Brazed Seam Terminals** brazed seam will not split open under the most extreme installation and operating conditions
- **Heat Shrinkable Tubing** 3:1 dual wall tubing with adhesive lining provides a waterproof seal with durable abrasion resistance and unequalled strain relief.
- **Polyolefin or Nylon Tubing** the most complete heat shrinkable connector offering is now stocked in two styles
- **Packaged or Bulk** available in convenient packaged quantities or order in bulk and save



Butt Splices

POLY CAT NO:	NYLON CAT NO:	WIRE RANGE	QTY. PKG.
31130	32130N	22-18 GA.	5000
31130-P500	32130N-P500	22-18 GA.	500
31130-P50	32130N-P50	22-18 GA.	50
31330	32330N	16-14 GA.	5000
31330-P500	32330N-P500	16-14 GA.	500
31330-P50	32330N-P50	16-14 GA.	50
31430	32430N	12-10 GA.	2500
31430-P250	32430N-P250	12-10 GA.	250
31430-P25	32430N-P25	12-10 GA.	25
31530	32530N	8 GA.	250
31530-P25	32530N-P25	8 GA.	25



31330



35430

Butt Splices: Step Down

POLY CAT NO:	NYLON CAT NO:	WIRE RANGE	COLOR	QTY. PKG.
35330	35330N	22-18 & 16-14 GA.	BLUE	500
35330-P50	35330N-P50	22-18 & 16-14 GA.	BLUE	50
35430	35430N	16-14 & 12-10 GA.	YELLOW	250
35430-P25	35430N-P25	16-14 & 12-10 GA.	YELLOW	25
35530	35530N	12-10 & 8 GA.	PINK	250
35530-P25	35530N-P25	12-10 & 8 GA.	PINK	25

Butt Splices: 3 and 4 Way Type

POLY CAT NO:	NYLON CAT NO:	WIRE RANGE	STYLE	QTY. PKG.
31103	32103N	22-18 GA.	3 WAY	50
31104	32104N	22-18 GA.	4 WAY	50
31303	32303N	16-14 GA.	3 WAY	50
31304	32304N	16-14 GA.	4 WAY	50
31403	32403N	12-10 GA.	3 WAY	50
31404	32404N	12-10 GA.	4 WAY	50



31103



31304

• Easy Installation Steps:



Rings: Brazed Seam



POLY CAT NO:	NYLON CAT NO:	WIRE RANGE	STUD SIZE	QTY. PKG.
31112	32112N	22-18 GA.	6	500
31112-P50	32112N-P50	22-18 GA.	6	50
31113	32113N	22-18 GA.	8	500
31113-P50	32113N-P50	22-18 GA.	8	50
31114	32114N	22-18 GA.	10	500
31114-P50	32114N-P50	22-18 GA.	10	50
31115	32115N	22-18 GA.	1/4"	500
31115-P50	32115N-P50	22-18 GA.	1/4"	50
31116	32116N	22-18 GA.	5/16"	500
31116-P50	32116N-P50	22-18 GA.	5/16"	50
31117	32117N	22-18 GA.	3/8"	500
31117-P50	32117N-P50	22-18 GA.	3/8"	50
31312	32312N	16-14 GA.	6	500
31312-P50	32312N-P50	16-14 GA.	6	50
31313	32313N	16-14 GA.	8	500
31313-P50	32313N-P50	16-14 GA.	8	50
31314	32314N	16-14 GA.	10	500
31314-P50	32314N-P50	16-14 GA.	10	50
31315	32315N	16-14 GA.	1/4"	500
31315-P50	32315N-P50	16-14 GA.	1/4"	50
31316	32316N	16-14 GA.	5/16"	500
31316-P50	32316N-P50	16-14 GA.	5/16"	50
31317	32317N	16-14 GA.	3/8"	500
31317-P50	32317N-P50	16-14 GA.	3/8"	50
31412	32412N	12-10 GA.	6	250
31412-P25	32412N-P25	12-10 GA.	6	25
31413	32413N	12-10 GA.	8	250
31413-P25	32413N-P25	12-10 GA.	8	25
31414	32414N	12-10 GA.	10	250
31414-P25	32414N-P25	12-10 GA.	10	25
31415	32415N	12-10 GA.	1/4"	250
31415-P25	32415N-P25	12-10 GA.	1/4"	25
31416	32416N	12-10 GA.	5/16"	250
31416-P25	32416N-P25	12-10 GA.	5/16"	25
31417	32417N	12-10 GA.	3/8"	250
31417-P25	32417N-P25	12-10 GA.	3/8"	25
31419	32419N	12-10 GA.	1/2"	250
31419-P25	32419N-P25	12-10 GA.	1/2"	25
31514	32514N	8 GA.	10	250
31514-P25	32514N-P25	8 GA.	10	25
31515	32515N	8 GA.	1/4"	250
31515-P25	32515N-P25	8 GA.	1/4"	25
31516	32516N	8 GA.	5/16"	250
31516-P25	32516N-P25	8 GA.	5/16"	25
31517	32517N	8 GA.	3/8"	250
31517-P25	32517N-P25	8 GA.	3/8"	25
31519	32519N	8 GA.	1/2"	250
31519-P25	32519N-P25	8 GA.	1/2"	25



31113



31314



31414



31515

Crimp 'N Seal® (Cont.)



State of the art manufacturing equipment and engineering.



Rings: Brazed Seam Multi-Stud



POLY CAT NO:	NYLON CAT NO:	WIRE RANGE	STUD SIZE	QTY. PKG.
3111MS	3211MSN	22-18 GA.	2,4,6	500
3111MS-P50	3211MSN-P50	22-18 GA.	2,4,6	50
3111M	3211MN	22-18 GA.	6,8,10	500
3111M-P50	3211MN-P50	22-18 GA.	6,8,10	50
3131MS	3231MSN	16-14 GA.	2,4,6	500
3131MS-P50	3231MSN-P50	16-14 GA.	2,4,6	50
3131M	3231MN	16-14 GA.	6,8,10	500
3131M-P50	3231MN-P50	16-14 GA.	6,8,10	50
3141M	3241MN	12-10 GA.	6,8,10	250
3141M-P25	3241MN-P25	12-10 GA.	6,8,10	25



3111M

Spades/Forks: Brazed Seam



POLY CAT NO:	NYLON CAT NO:	WIRE RANGE	STUD SIZE	QTY. PKG.
31122	32122N	22-18 GA.	6	500
31122-P50	32122N-P50	22-18 GA.	6	50
31123	32123N	22-18 GA.	8	500
31123-P50	32123N-P50	22-18 GA.	8	50
31124	32124N	22-18 GA.	10	500
31124-P50	32124N-P50	22-18 GA.	10	50
31322	32322N	16-14 GA.	6	500
31322-P50	32322N-P50	16-14 GA.	6	50
31323	32323N	16-14 GA.	8	500
31323-P50	32323N-P50	16-14 GA.	8	50
31324	32324N	16-14 GA.	10	500
31324-P50	32324N-P50	16-14 GA.	10	50
31422	32422N	12-10 GA.	6	250
31422-P25	32422N-P25	12-10 GA.	6	25
31423	32423N	12-10 GA.	8	250
31423-P25	32423N-P25	12-10 GA.	8	25
31424	32424N	12-10 GA.	10	250
31424-P25	32424N-P25	12-10 GA.	10	25



31323

Snap Spade/Locking Forks: Brazed Seam

POLY CAT NO:	NYLON CAT NO:	WIRE RANGE	STUD SIZE	QTY. PKG.
31142	32142N	22-18 GA.	6	500
31142-P50	32142N-P50	22-18 GA.	6	50
31143	32143N	22-18 GA.	8	500
31143-P50	32143N-P50	22-18 GA.	8	50
31144	32144N	22-18 GA.	10	500
31144-P50	32144N-P50	22-18 GA.	10	50
31342	32342N	16-14 GA.	6	500
31342-P50	32342N-P50	16-14 GA.	6	50
31343	32343N	16-14 GA.	8	500
31343-P50	32343N-P50	16-14 GA.	8	50
31344	32344N	16-14 GA.	10	500
31344-P50	32344N-P50	16-14 GA.	10	50
31442	32442N	12-10 GA.	6	250
31442-P25	32442N-P25	12-10 GA.	6	25
31443	32443N	12-10 GA.	8	250
31443-P25	32443N-P25	12-10 GA.	8	25
31444	32444N	12-10 GA.	10	250
31444-P25	32444N-P25	12-10 GA.	10	25
31445	32445N	12-10 GA.	1/4"	250
31445-P25	32445N-P25	12-10 GA.	1/4"	25



31344

Flanged Forks: Brazed Seam

POLY CAT NO:	NYLON CAT NO:	WIRE RANGE	STUD SIZE	QTY. PKG.
31122FL	32122FLN	22-18 GA.	6	500
31122FL-P50	32122FLN-P50	22-18 GA.	6	50
31123FL	32123FLN	22-18 GA.	8	500
31123FL-P50	32123FLN-P50	22-18 GA.	8	50
31124FL	32124FLN	22-18 GA.	10	500
31124FL-P50	32124FLN-P50	22-18 GA.	10	50
31322FL	32322FLN	16-14 GA.	6	500
31322FL-P50	32322FLN-P50	16-14 GA.	6	50
31323FL	32323FLN	16-14 GA.	8	500
31323FL-P50	32323FLN-P50	16-14 GA.	8	50
31324FL	32324FLN	16-14 GA.	10	500
31324FL-P50	32324FLN-P50	16-14 GA.	10	50
31422FL	32422FLN	12-10 GA.	6	250
31422FL-P25	32422FLN-P25	12-10 GA.	6	25
31423FL	32423FLN	12-10 GA.	8	250
31423FL-P25	32423FLN-P25	12-10 GA.	8	25
31424FL	32424FLN	12-10 GA.	10	250
31424FL-P25	32424FLN-P25	12-10 GA.	10	25



31324FL

Crimp 'N Seal® (Cont.)



Controlled Cycle Crimp Tool

Part No. 94130
See Page 70



Hooks: Butted Seam



31154

POLY CAT NO:	NYLON CAT NO:	WIRE RANGE	STUD SIZE	QTY. PKG.
31152	32152N	22-18 GA.	6	500
31152-P50	32152N-P50	22-18 GA.	6	50
31153	32153N	22-18 GA.	8	500
31153-P50	32153N-P50	22-18 GA.	8	50
31154	32154N	22-18 GA.	10	500
31154-P50	32154N-P50	22-18 GA.	10	50
31352	32352N	16-14 GA.	6	500
31352-P50	32352N-P50	16-14 GA.	6	50
31353	32353N	16-14 GA.	8	500
31353-P50	32353N-P50	16-14 GA.	8	50
31354	32354N	16-14 GA.	10	500
31354-P50	32354N-P50	16-14 GA.	10	50
31452	32452N	12-10 GA.	6	250
31452-P25	32452N-P25	12-10 GA.	6	25
31453	32453N	12-10 GA.	8	250
31453-P25	32453N-P25	12-10 GA.	8	25
31454	32454N	12-10 GA.	10	250
31454-P25	32454N-P25	12-10 GA.	10	25

Quick Disconnects: Fully Insulated - Double Hump



30187



30197

POLY CAT NO:	WIRE RANGE	TAB SIZE	STYLE	QTY. PKG.
30185	22-18 GA.	.187 X .020	MALE	500
30185-P50	22-18 GA.	.187 X .020	MALE	50
30187	22-18 GA.	.250 X .032	MALE	500
30187-P50	22-18 GA.	.250 X .032	MALE	50
30195	22-18 GA.	.187 X .020	FEMALE	500
30195-P50	22-18 GA.	.187 X .020	FEMALE	50
30197	22-18 GA.	.250 X .032	FEMALE	500
30197-P50	22-18 GA.	.250 X .032	FEMALE	50
30385	16-14 GA.	.187 X .020	MALE	500
30385-P50	16-14 GA.	.187 X .020	MALE	50
30387	16-14 GA.	.250 X .032	MALE	500
30387-P50	16-14 GA.	.250 X .032	MALE	50
30395	16-14 GA.	.187 X .020	FEMALE	500
30395-P50	16-14 GA.	.187 X .020	FEMALE	50
30397	16-14 GA.	.250 X .032	FEMALE	500
30397-P50	16-14 GA.	.250 X .032	FEMALE	50
30487	12-10 GA.	.250 X .032	MALE	250
30487-P25	12-10 GA.	.250 X .032	MALE	25
30497	12-10 GA.	.250 X .032	FEMALE	250
30497-P25	12-10 GA.	.250 X .032	FEMALE	25



Quick Disconnects: Fully Insulated - Single Hump

POLY CAT NO:	WIRE RANGE	TAB SIZE	STYLE	QTY. PKG.
30186	22-18 GA.	.187 X .020	MALE	500
30186-P50	22-18 GA.	.187 X .020	MALE	50
30188	22-18 GA.	.250 X .032	MALE	500
30188-P50	22-18 GA.	.250 X .032	MALE	50
30196	22-18 GA.	.187 X .020	FEMALE	500
30196-P50	22-18 GA.	.187 X .020	FEMALE	50
30198	22-18 GA.	.250 X .032	FEMALE	500
30198-P50	22-18 GA.	.250 X .032	FEMALE	50
30386	16-14 GA.	.187 X .020	MALE	500
30386-P50	16-14 GA.	.187 X .020	MALE	50
30388	16-14 GA.	.250 X .032	MALE	500
30388-P50	16-14 GA.	.250 X .032	MALE	50
30396	16-14 GA.	.187 X .020	FEMALE	500
30396-P50	16-14 GA.	.187 X .020	FEMALE	50
30398	16-14 GA.	.250 X .032	FEMALE	500
30398-P50	16-14 GA.	.250 X .032	FEMALE	50
30488	12-10 GA.	.250 X .032	MALE	250
30488-P25	12-10 GA.	.250 X .032	MALE	25
30498	12-10 GA.	.250 X .032	FEMALE	250
30498-P25	12-10 GA.	.250 X .032	FEMALE	25



30387

Quick Disconnects

POLY CAT NO:	NYLON CAT NO:	WIRE RANGE	TAB SIZE	STYLE	QTY. PKG.
31184	32184N	22-18 GA.	.187 X .020	MALE	500
31184-P50	32184N-P50	22-18 GA.	.187 X .020	MALE	50
31183	32183N	22-18 GA.	.250 X .032	MALE	500
31183-P50	32183N-P50	22-18 GA.	.250 X .032	MALE	50
31194	32194N	22-18 GA.	.187 X .020	FEMALE	500
31194-P50	32194N-P50	22-18 GA.	.187 X .020	FEMALE	50
31193	32193N	22-18 GA.	.250 X .032	FEMALE	500
31193-P50	32193N-P50	22-18 GA.	.250 X .032	FEMALE	50
31384	32384N	16-14 GA.	.187 X .020	MALE	500
31384-P50	32384N-P50	16-14 GA.	.187 X .020	MALE	50
31383	32383N	16-14 GA.	.250 X .032	MALE	500
31383-P50	32383N-P50	16-14 GA.	.250 X .032	MALE	50
31394	32394N	16-14 GA.	.187 X .020	FEMALE	500
31394-P50	32394N-P50	16-14 GA.	.187 X .020	FEMALE	50
31393	32393N	16-14 GA.	.250 X .032	FEMALE	500
31393-P50	32393N-P50	16-14 GA.	.250 X .032	FEMALE	50
31483	32483N	12-10 GA.	.250 X .032	MALE	250
31483-P25	32483N-P25	12-10 GA.	.250 X .032	MALE	25
31493	32493N	12-10 GA.	.250 X .032	FEMALE	250
31493-P25	32493N-P25	12-10 GA.	.250 X .032	FEMALE	25



31383



Crimp 'N Seal® (Cont.)



Quick Disconnects: Piggy-Back

POLY CAT NO:	NYLON CAT NO:	WIRE RANGE	TAB SIZE	QTY. PKG.
31191	32191N	22-18 GA.	.250 X .032	500
31191-P50	32191N-P50	22-18 GA.	.250 X .032	50
31391	32391N	16-14 GA.	.250 X .032	500
31391-P50	32391N-P50	16-14 GA.	.250 X .032	50

Bullets\Receptacles

POLY CAT NO:	NYLON CAT NO:	WIRE RANGE	MATING SIZE	STYLE	QTY. PKG.
31169	32169N	22-18 GA.	.156"	MALE	500
31169-P50	32169N-P50	22-18 GA.	.156"	MALE	50
31168	32168N	22-18 GA.	.180"	MALE	500
31168-P50	32168N-P50	22-18 GA.	.180"	MALE	50
30179	-	22-18 GA.	.156"	FEMALE	500
30179-P50	-	22-18 GA.	.156"	FEMALE	50
30178	-	22-18 GA.	.180"	FEMALE	500
30178-P50	-	22-18 GA.	.180"	FEMALE	50
31369	32369N	16-14 GA.	.156"	MALE	500
31369-P50	32369N-P50	16-14 GA.	.156"	MALE	50
31368	32368N	16-14 GA.	.180"	MALE	500
31368-P50	32368N-P50	16-14 GA.	.180"	MALE	50
30379	-	16-14 GA.	.156"	FEMALE	500
30379-P50	-	16-14 GA.	.156"	FEMALE	50
30378	-	16-14 GA.	.180"	FEMALE	500
30378-P50	-	16-14 GA.	.180"	FEMALE	50
31469	32469N	12-10 GA.	.156"	MALE	250
31469-P25	32469N-P25	12-10 GA.	.156"	MALE	25



31369



30379



31465

Pin Terminals

POLY CAT NO:	NYLON CAT NO:	WIRE RANGE	PIN DIAMETER	QTY. PKG.
31165	32165N	22-18 GA.	0.08	500
31165-P50	32165N-P50	22-18 GA.	0.08	50
31365	32365N	16-14 GA.	0.08	500
31365-P50	32365N-P50	16-14 GA.	0.08	50
31465	32465N	12-10 GA.	0.11	250
31465-P25	32465N-P25	12-10 GA.	0.11	25

Standard Solderless Terminals

FTZ has expanded its line of standard solderless terminals to include non-insulated and hi-temperature terminals as well as adding many new sizes and styles. All of our terminals are now available in bulk or packaged quantities for your convenience.

Butt Splices

NYLON CAT NO:	VINYL CAT NO:	NON-INSULATED CAT NO:	HIGH TEMP. CAT NO:	WIRE RANGE	PKG. QTY.
45130N	45130	46130	40130	22-18 GA	5000
45130N-P1000	45130-P1000	46130-P1000	40130-P1000	22-18 GA.	1000
45130N-P100	45130-P100	46130-P100	40130-P100	22-18 GA.	100
45330N	45330	46330	40330	16-14 GA.	5000
45330N-P1000	45330-P1000	46330-P1000	40330-P1000	16-14 GA.	1000
45330N-P100	45330-P100	46330-P100	40330-P100	16-14 GA.	100
45430N	45430	46430	40430	12-10 GA.	2500
45430N-P500	45430-P500	46430-P500	40430-P500	12-10 GA.	500
45430N-P50	45430-P50	46430-P50	40430-P50	12-10 GA.	50
	45530	46530	-	8 GA.	500
	45530-P50	46530-P50	-	8 GA.	50
	45630	46630	-	6 GA.	250
	45630-P25	46630-P25	-	6 GA.	25
	45730	46730	-	4 GA.	250
	45730-P25	46730-P25	-	4 GA.	25



45330



45330N

Butt Splices with Insulation Grip

NYLON CAT NO:	VINYL CAT NO:	NON-INSULATED CAT NO:	HIGH TEMP. CAT NO:	WIRE RANGE	PKG. QTY.
45133N	-	-	-	22-18 GA.	1000
45133N-P100	-	-	-	22-18 GA.	100
45333N	-	-	-	16-14 GA.	1000
45333N-P100	-	-	-	16-14 GA.	100
45433N	-	-	-	12-10 GA.	500
45433N-P50	-	-	-	12-10 GA.	50

Butt Splices: Step Down

NYLON CAT NO:	VINYL CAT NO:	NON-INSULATED CAT NO:	HIGH TEMP. CAT NO:	WIRE RANGE	PKG. QTY.
	45333	46333	-	22-18 & 16-14 GA.	1000
	45333-P100	46333-P100	-	22-18 & 16-14 GA.	100
	45433	46433	-	16-14 & 12-10 GA.	500
	45433-P50	46433-P50	-	16-14 & 12-10 GA.	50
	45533	46533	-	12-10 & 8 GA.	500
	45533-P50	46533-P50	-	12-10 & 8 GA.	50
	45633	46633	-	8 GA. & 6 GA.	250
	45633-P25	46633-P25	-	8 GA. & 6 GA.	25



45333



45433



45633

Standard Solderless Terminals (Cont.)



Multi-Purpose tool
cuts, strips and
crimps.

Part No. 94144
See Page 70



45203

Butt Splices: 3 and 4 Way Type

NYLON CAT NO:	VINYL CAT NO:	WIRE RANGE	STYLE	PKG. QTY.
45203N	45203	22-18 GA.	3 WAY	100
45204N	45204	22-18 GA.	4 WAY	100
45303N	45303	16-14 GA.	3 WAY	100
45304N	45304	16-14 GA.	4 WAY	100
45403N	45403	12-10 GA.	3 WAY	50
45404N	45404	12-10 GA.	4 WAY	50



45304N

Closed End Connectors/Pigtails

NYLON CAT NO:	WIRE RANGE	COLOR	PKG. QTY.
45189N	22-14 GA.	CLEAR	100
45389N	22-12 GA.	CLEAR	100
45489N	16-10 GA.	CLEAR	100
45589N	8 GA.	CLEAR	100



45389N

Parallel Splices

NYLON CAT NO:	VINYL CAT NO:	NON-INSULATED CAT NO:	WIRE RANGE	PKG. QTY.
	45131	46131	22-18 GA.	1000
	45131-P100	46131-P100	22-18 GA.	100
	45331	46331	16-14 GA.	1000
	45331-P100	46331-P100	16-14 GA.	100
	45431	46431	12-10 GA.	500
	45431-P50	46431-P50	12-10 GA.	50
	45531	46531	8 GA.	500
	45531-P50	46531-P50	8 GA.	50
	45631	46631	6 GA.	250
	45631-P25	46631-P25	6 GA.	25
	45731	46731	4 GA.	250
	45731-P25	46731-P25	4 GA.	25



45331

Rings

NYLON CAT NO:	VINYL CAT NO:	NON-INSULATED CAT NO:	HIGH TEMP. CAT NO:	WIRE RANGE	STUD SIZE	PKG. QTY.
45112N	45112	46112	40112	22-18 GA.	6	1000
45112N-P100	45112-P100	46112-P100	40112-P100	22-18 GA.	6	100
45113N	45113	46113	40113	22-18 GA.	8	1000
45113N-P100	45113-P100	46113-P100	40113-P100	22-18 GA.	8	100
45114N	45114	46114	40114	22-18 GA.	10	1000
45114N-P100	45114-P100	46114-P100	40114-P100	22-18 GA.	10	100
45115N	45115	46115	40115	22-18 GA.	1/4"	1000
45115N-P100	45115-P100	46115-P100	40115-P100	22-18 GA.	1/4"	100
45116N	45116	46116	-	22-18 GA.	5/16"	1000
45116N-P100	45116-P100	46116-P100	-	22-18 GA.	5/16"	100
45117N	45117	46117	-	22-18 GA.	3/8"	1000
45117N-P100	45117-P100	46117-P100	-	22-18 GA.	3/8"	100
45312N	45312	46312	40312	16-14 GA.	6	1000
45312N-P100	45312-P100	46312-P100	40312-P100	16-14 GA.	6	100
45313N	45313	46313	40313	16-14 GA.	8	1000
45313N-P100	45313-P100	46313-P100	40313-P100	16-14 GA.	8	100
45314N	45314	46314	40314	16-14 GA.	10	1000
45314N-P100	45314-P100	46314-P100	40314-P100	16-14 GA.	10	100
45315N	45315	46315	40315	16-14 GA.	1/4"	1000
45315N-P100	45315-P100	46315-P100	40315-P100	16-14 GA.	1/4"	100
45316N	45316	46316	-	16-14 GA.	5/16"	1000
45316N-P100	45316-P100	46316-P100	-	16-14 GA.	5/16"	100
45317N	45317	46317	-	16-14 GA.	3/8"	1000
45317N-P100	45317-P100	46317-P100	-	16-14 GA.	3/8"	100
45412N	45412	46412	40412	12-10 GA.	6	500
45412N-P50	45412-P50	46412-P50	40412-P50	12-10 GA.	6	50
45413N	45413	46413	40413	12-10 GA.	8	500
45413N-P50	45413-P50	46413-P50	40413-P50	12-10 GA.	8	50
45414N	45414	46414	40414	12-10 GA.	10	500
45414N-P50	45414-P50	46414-P50	40414-P50	12-10 GA.	10	50
45415N	45415	46415	40415	12-10 GA.	1/4"	500
45415N-P50	45415-P50	46415-P50	40415-P50	12-10 GA.	1/4"	50
45416N	45416	46416	40416	12-10 GA.	5/16"	500
45416N-P50	45416-P50	46416-P50	40416-P50	12-10 GA.	5/16"	50
45417N	45417	46417	40417	12-10 GA.	3/8"	500
45417N-P50	45417-P50	46417-P50	40417-P50	12-10 GA.	3/8"	50
45419N	45419	46419	-	12-10 GA.	1/2"	500
45419N-P50	45419-P50	46419-P50	-	12-10 GA.	1/2"	50
45514N	45514	46514	-	8 GA.	10	500
45514N-P50	45514-P50	46514-P50	-	8 GA.	10	50
45515N	45515	46515	40515	8 GA.	1/4"	500
45515N-P50	45515-P50	46515-P50	40515-P50	8 GA.	1/4"	50
45516N	45516	46516	-	8 GA.	5/16"	500
45516N-P50	45516-P50	46516-P50	-	8 GA.	5/16"	50
45517N	45517	46517	-	8 GA.	3/8"	500
45517N-P50	45517-P50	46517-P50	-	8 GA.	3/8"	50
45519N	45519	46519	-	8 GA.	1/2"	500
45519N-P50	45519-P50	46519-P50	-	8 GA.	1/2"	50
45614N	45614	46614	-	6 GA.	10	250
45614N-P25	45614-P25	46614-P25	-	6 GA.	10	25
45615N	45615	46615	-	6 GA.	1/4"	250
45615N-P25	45615-P25	46615-P25	-	6 GA.	1/4"	25
45616N	45616	46616	-	6 GA.	5/16"	250
45616N-P25	45616-P25	46616-P25	-	6 GA.	5/16"	25
45617N	45617	46617	40617	6 GA.	3/8"	250
45617N-P25	45617-P25	46617-P25	40617-P25	6 GA.	3/8"	25
45619N	45619	46619	-	6 GA.	1/2"	250
45619N-P25	45619-P25	46619-P25	-	6 GA.	1/2"	25
45714N	45714	46714	-	4 GA.	10	250
45714N-P25	45714-P25	46714-P25	-	4 GA.	10	25
45715N	45715	46715	-	4 GA.	1/4"	250
45715N-P25	45715-P25	46715-P25	-	4 GA.	1/4"	25
45716N	45716	46716	-	4 GA.	5/16"	250
45716N-P25	45716-P25	46716-P25	-	4 GA.	5/16"	25
45717N	45717	46717	40717	4 GA.	3/8"	250
45717N-P25	45717-P25	46717-P25	40717-P25	4 GA.	3/8"	25
45719N	45719	46719	-	4 GA.	1/2"	250
45719N-P25	45719-P25	46719-P25	-	4 GA.	1/2"	25



45114N



45314



45615

Standard Solderless Terminals (Cont.)

Rings: Multi-Stud

NYLON CAT NO:	VINYL CAT NO:	NON-INSULATED CAT NO:	WIRE RANGE	STUD SIZE	PKG. QTY.
4511MSN	4511MS	4611MS	22-18 GA.	2,4,6	1000
4511MSN-P100	4511MS-P100	4611MS-P100	22-18 GA.	2,4,6	100
4511MN	4511M	4611M	22-18 GA.	6,8,10	1000
4511MN-P100	4511M-P100	4611M-P100	22-18 GA.	6,8,10	100
4531MSN	4531MS	4631MS	16-14 GA.	2,4,6	1000
4531MSN-P100	4531MS-P100	4631MS-P100	16-14 GA.	2,4,6	100
4531MN	4531M	4631M	16-14 GA.	6,8,10	1000
4531MN-P100	4531M-P100	4631M-P100	16-14 GA.	6,8,10	100
4541MN	4541M	4641M	12-10 GA.	6,8,10	500
4541MN-P50	4541M-P50	4641M-P50	12-10 GA.	6,8,10	50



4511M

Spades/Forks

NYLON CAT NO:	VINYL CAT NO:	NON-INSULATED CAT NO:	WIRE RANGE	STUD SIZE	PKG. QTY.
45122N	45122	46122	22-18 GA.	6	1000
45122N-P100	45122-P100	46122-P100	22-18 GA.	6	100
45123N	45123	46123	22-18 GA.	8	1000
45123N-P100	45123-P100	46123-P100	22-18 GA.	8	100
45124N	45124	46124	22-18 GA.	10	1000
45124N-P100	45124-P100	46124-P100	22-18 GA.	10	100
45322N	45322	46322	16-14 GA.	6	1000
45322N-P100	45322-P100	46322-P100	16-14 GA.	6	100
45323N	45323	46323	16-14 GA.	8	1000
45323N-P100	45323-P100	46323-P100	16-14 GA.	8	100
45324N	45324	46324	16-14 GA.	10	1000
45324N-P100	45324-P100	46324-P100	16-14 GA.	10	100
45422N	45422	46422	12-10 GA.	6	500
45422N-P50	45422-P50	46422-P50	12-10 GA.	6	50
45423N	45423	46423	12-10 GA.	8	500
45423N-P50	45423-P50	46423-P50	12-10 GA.	8	50
45424N	45424	46424	12-10 GA.	10	500
45424N-P50	45424-P50	46424-P50	12-10 GA.	10	50



45123N

Snap Spades/Locking Forks

NYLON CAT NO:	VINYL CAT NO:	NON-INSULATED CAT NO:	WIRE RANGE	STUD SIZE	PKG. QTY.
45142N	45142	46142	22-18 GA.	6	1000
45142N-P100	45142-P100	46142-P100	22-18 GA.	6	100
45143N	45143	46143	22-18 GA.	8	1000
45143N-P100	45143-P100	46143-P100	22-18 GA.	8	100
45144N	45144	46144	22-18 GA.	10	1000
45144N-P100	45144-P100	46144-P100	22-18 GA.	10	100
45342N	45342	46342	16-14 GA.	6	1000
45342N-P100	45342-P100	46342-P100	16-14 GA.	6	100
45343N	45343	46343	16-14 GA.	8	1000
45343N-P100	45343-P100	46343-P100	16-14 GA.	8	100
45344N	45344	46344	16-14 GA.	10	1000
45344N-P100	45344-P100	46344-P100	16-14 GA.	10	100
45442N	45442	46442	12-10 GA.	6	500
45442N-P50	45442-P50	46442-P50	12-10 GA.	6	50
45443N	45443	46443	12-10 GA.	8	500
45443N-P50	45443-P50	46443-P50	12-10 GA.	8	50
45444N	45444	46444	12-10 GA.	10	500
45444N-P50	45444-P50	46444-P50	12-10 GA.	10	50
45445N	45445	46445	12-10 GA.	1/4"	500
45445N-P50	45445-P50	46445-P50	12-10 GA.	1/4"	50



45444N

Flanged Forks

NYLON CAT NO:	VINYL CAT NO:	NON-INSULATED CAT NO:	WIRE RANGE	STUD SIZE	PKG. QTY.
45122FLN	45122FL	46122FL	22-18 GA.	6	1000
45122FLN-P100	45122FL-P100	46122FL-P100	22-18 GA.	6	100
45123FLN	45123FL	46123FL	22-18 GA.	8	1000
45123FLN-P100	45123FL-P100	46123FL-P100	22-18 GA.	8	100
45124FLN	45124FL	46124FL	22-18 GA.	10	1000
45124FLN-P100	45124FL-P100	46124FL-P100	22-18 GA.	10	100
45322FLN	45322FL	46322FL	16-14 GA.	6	1000
45322FLN-P100	45322FL-P100	46322FL-P100	16-14 GA.	6	100
45323FLN	45323FL	46323FL	16-14 GA.	8	1000
45323FLN-P100	45323FL-P100	46323FL-P100	16-14 GA.	8	100
45324FLN	45324FL	46324FL	16-14 GA.	10	1000
45324FLN-P100	45324FL-P100	46324FL-P100	16-14 GA.	10	100
45422FLN	45422FL	46422FL	12-10 GA.	6	500
45422FLN-P50	45422FL-P50	46422FL-P50	12-10 GA.	6	50
45423FLN	45423FL	46423FL	12-10 GA.	8	500
45423FLN-P50	45423FL-P50	46423FL-P50	12-10 GA.	8	50
45424FLN	45424FL	46424FL	12-10 GA.	10	500
45424FLN-P50	45424FL-P50	46424FL-P50	12-10 GA.	10	50



45424FLN

Hooks

NYLON CAT NO:	VINYL CAT NO:	NON-INSULATED CAT NO:	WIRE RANGE	STUD SIZE	PKG. QTY.
45152N	45152	46152	22-18 GA.	6	1000
45152N-P100	45152-P100	46152-P100	22-18 GA.	6	100
45153N	45153	46153	22-18 GA.	8	1000
45153N-P100	45153-P100	46153-P100	22-18 GA.	8	100
45154N	45154	46154	22-18 GA.	10	1000
45154N-P100	45154-P100	46154-P100	22-18 GA.	10	100
45352N	45352	46352	16-14 GA.	6	1000
45352N-P100	45352-P100	46352-P100	16-14 GA.	6	100
45353N	45353	46353	16-14 GA.	8	1000
45353N-P100	45353-P100	46353-P100	16-14 GA.	8	100
45354N	45354	46354	16-14 GA.	10	1000
45354N-P100	45354-P100	46354-P100	16-14 GA.	10	100
45452N	45452	46452	12-10 GA.	6	500
45452N-P50	45452-P50	46452-P50	12-10 GA.	6	50
45453N	45453	46453	12-10 GA.	8	500
45453N-P50	45453-P50	46453-P50	12-10 GA.	8	50
45454N	45454	46454	12-10 GA.	10	500
45454N-P50	45454-P50	46454-P50	12-10 GA.	10	50



45354N

Standard Solderless Terminals (Cont.)



45387N

Quick Disconnects: Fully Insulated: Double Hump Type

NYLON CAT NO:	WIRE RANGE	TAB SIZE	STYLE	PKG. QTY.
45185N	22-18 GA.	.187 X .020	MALE	1000
45185N-P100	22-18 GA.	.187 X .020	MALE	100
45187N	22-18 GA.	.250 X .032	MALE	1000
45187N-P100	22-18 GA.	.250 X .032	MALE	100
45195N	22-18 GA.	.187 X .020	FEMALE	1000
45195N-P100	22-18 GA.	.187 X .020	FEMALE	100
45197N	22-18 GA.	.250 X .032	FEMALE	1000
45197N-P100	22-18 GA.	.250 X .032	FEMALE	100
45385N	16-14 GA.	.187 X .020	MALE	1000
45385N-P100	16-14 GA.	.187 X .020	MALE	100
45387N	16-14 GA.	.250 X .032	MALE	1000
45387N-P100	16-14 GA.	.250 X .032	MALE	100
45395N	16-14 GA.	.187 X .020	FEMALE	1000
45395N-P100	16-14 GA.	.187 X .020	FEMALE	100
45397N	16-14 GA.	.250 X .032	FEMALE	1000
45397N-P100	16-14 GA.	.250 X .032	FEMALE	100
45487N	12-10 GA.	.250 X .032	MALE	500
45487N-P50	12-10 GA.	.250 X .032	MALE	50
45497N	12-10 GA.	.250 X .032	FEMALE	500
45497N-P50	12-10 GA.	.250 X .032	FEMALE	50

Quick Disconnects: Fully Insulated: Single Hump Type

NYLON CAT NO:	WIRE RANGE	TAB SIZE	STYLE	PKG. QTY.
45186N	22-18 GA.	.187 X .020	MALE	1000
45186N-P100	22-18 GA.	.187 X .020	MALE	100
45188N	22-18 GA.	.250 X .032	MALE	1000
45188N-P100	22-18 GA.	.250 X .032	MALE	100
45196N	22-18 GA.	.187 X .020	FEMALE	1000
45196N-P100	22-18 GA.	.187 X .020	FEMALE	100
45198N	22-18 GA.	.250 X .032	FEMALE	1000
45198N-P100	22-18 GA.	.250 X .032	FEMALE	100
45386N	16-14 GA.	.187 X .020	MALE	1000
45386N-P100	16-14 GA.	.187 X .020	MALE	100
45388N	16-14 GA.	.250 X .032	MALE	1000
45388N-P100	16-14 GA.	.250 X .032	MALE	100
45396N	16-14 GA.	.187 X .020	FEMALE	1000
45396N-P100	16-14 GA.	.187 X .020	FEMALE	100
45398N	16-14 GA.	.250 X .032	FEMALE	1000
45398N-P100	16-14 GA.	.250 X .032	FEMALE	100
45488N	12-10 GA.	.250 X .032	MALE	500
45488N-P50	12-10 GA.	.250 X .032	MALE	50
45498N	12-10 GA.	.250 X .032	FEMALE	500
45498N-P50	12-10 GA.	.250 X .032	FEMALE	50

Quick Disconnects

NYLON CAT NO:	VINYL CAT NO:	NON-INSULATED CAT NO:	WIRE RANGE	TAB SIZE	STYLE	PKG. QTY.
45184N	45184	46184	22-18 GA.	.187 X .020	MALE	1000
45184N-P100	45184-P100	46184-P100	22-18 GA.	.187 X .020	MALE	100
45183N	45183	46183	22-18 GA.	.250 X .032	MALE	1000
45183N-P100	45183-P100	46183-P100	22-18 GA.	.250 X .032	MALE	100
45194N	45194	46194	22-18 GA.	.187 X .020	FEMALE	1000
45194N-P100	45194-P100	46194-P100	22-18 GA.	.187 X .020	FEMALE	100
45193N	45193	46193	22-18 GA.	.250 X .032	FEMALE	1000
45193N-P100	45193-P100	46193-P100	22-18 GA.	.250 X .032	FEMALE	100
45384N	45384	46384	16-14 GA.	.187 X .020	MALE	1000
45384N-P100	45384-P100	46384-P100	16-14 GA.	.187 X .020	MALE	100
45383N	45383	46383	16-14 GA.	.250 X .032	MALE	1000
45383N-P100	45383-P100	46383-P100	16-14 GA.	.250 X .032	MALE	100
45394N	45394	46394	16-14 GA.	.187 X .020	FEMALE	1000
45394N-P100	45394-P100	46394-P100	16-14 GA.	.187 X .020	FEMALE	100
45393N	45393	46393	16-14 GA.	.250 X .032	FEMALE	1000
45393N-P100	45393-P100	46393-P100	16-14 GA.	.250 X .032	FEMALE	100
45483N	45483	46483	12-10 GA.	.250 X .032	MALE	500
45483N-P50	45483-P50	46483-P50	12-10 GA.	.250 X .032	MALE	50
45493N	45493	46493	12-10 GA.	.250 X .032	FEMALE	500
45493N-P50	45493-P50	46493-P50	12-10 GA.	.250 X .032	FEMALE	50



45383N



45393

Specialty Quick Disconnects

NYLON CAT NO:	VINYL CAT NO:	WIRE RANGE	TAB SIZE	STYLE	PKG. QTY.
45177N	45177	22-18 GA.	.250 X .032	FEMALE FLAG	1000
45177N-P100	45177-P100	22-18 GA.	.250 X .032	FEMALE FLAG	100
45377N	45377	16-14 GA.	.250 X .032	FEMALE FLAG	1000
45377N-P100	45377-P100	16-14 GA.	.250 X .032	FEMALE FLAG	100
45477N	45477	12-10 GA.	.250 X .032	FEMALE FLAG	500
45477N-P50	45477-P50	12-10 GA.	.250 X .032	FEMALE FLAG	50
45191N	45191	22-18 GA.	.250 X .032	PIGGY BACK	1000
45191N-P100	45191-P100	22-18 GA.	.250 X .032	PIGGY BACK	100
45391N	45391	16-14 GA.	.250 X .032	PIGGY BACK	1000
45391N-P100	45391-P100	16-14 GA.	.250 X .032	PIGGY BACK	100



45391



45377N

Standard Solderless Terminals (Cont.)

Bullets/Receptacles



45368N



45378N

NYLON CAT NO:	VINYL CAT NO:	NON-INSULATED CAT NO:	WIRE RANGE	MATING SIZE	STYLE	PKG. QTY.
45169N	45169	46169	22-18 GA.	.156"	MALE	1000
45169N-P100	45169-P100	46169-P100	22-18 GA.	.156"	MALE	100
45168N	45168	46168	22-18 GA.	.180"	MALE	1000
45168N-P100	45168-P100	46168-P100	22-18 GA.	.180"	MALE	100
45179N	45179	-	22-18 GA.	.156"	FEMALE	1000
45179N-P100	45179-P100	-	22-18 GA.	.156"	FEMALE	100
45178N	45178	-	22-18 GA.	.180"	FEMALE	1000
45178N-P100	45178-P100	-	22-18 GA.	.180"	FEMALE	100
45369N	45369	46369	16-14 GA.	.156"	MALE	1000
45369N-P100	45369-P100	46369-P100	16-14 GA.	.156"	MALE	100
45368N	45368	46368	16-14 GA.	.180"	MALE	1000
45368N-P100	45368-P100	46368-P100	16-14 GA.	.180"	MALE	100
45379N	45379	-	16-14 GA.	.156"	FEMALE	1000
45379N-P100	45379-P100	-	16-14 GA.	.156"	FEMALE	100
45378N	45378	-	16-14 GA.	.180"	FEMALE	1000
45378N-P100	45378-P100	-	16-14 GA.	.180"	FEMALE	100

Pin Terminals



45465

NYLON CAT NO:	VINYL CAT NO:	NON-INSULATED CAT NO:	WIRE RANGE	PIN DIAMETER	PKG. QTY.
45165N	45165	46165	22-18 GA.	0.08	1000
45165N-P100	45165-P100	46165-P100	22-18 GA.	0.08	100
45365N	45365	46365	16-14 GA.	0.08	1000
45365N-P100	45365-P100	46365-P100	16-14 GA.	0.08	100
45465N	45465	46465	12-10 GA.	0.11	500
45465N-P50	45465-P50	46465-P50	12-10 GA.	0.11	50

Wire Taps & Specialty Connectors

CAT NO:	WIRE RANGE	COLOR	TYPE	PKG. QTY.
45900	22-14 GA.	CLEAR AND BLUE	Moisture resistant seal	50
45901	22-14 GA.	CLEAR	Dry Environment applications	50
45903	22-16 GA.	RED	Dual element action	100
45904	22-16 GA.	RED	Flame retardant tap	100
45905	18-14 GA.	LIGHT BLUE	Flame retardant tap	100
45906	18-14 GA.	TAN	Dry environment applications	500
45907	18-14 GA.	LIGHT BLUE	Tap and parallel	50
45908	18-14 GA.	DARK BLUE	Moisture resistant applications	25
45909	18-14 GA.	TAN	Dry environment applications	50
45910	18-14 GA.	BLACK	Disconnect	50
45911	18-14 GA. TAP; 12-10 GA. RUN	BROWN	Flame retardant tap	50
45912	12-10 GA.	YELLOW	Tap and parallel	50
45913	22-18 GA. TAP; 18-14 GA. RUN	RED	Flame retardant tap	50
45611	22-18 GA.	RED	T-tap disconnect	50
45610	18-14 GA.	BLUE	T-tap disconnect	50
45612	12 GA.	YELLOW	T-tap disconnect	50
45613	18-14 GA.	BLUE	Auto fuse holder	25
94145	Wire tap installation tool for all taps			1



45904



45908



45912



45611



45610



45612

Standard Solderless Terminals (Cont.)



Specialty Connectors: Vinyl Hard Shell

E CAT NO:	WIRE RANGE	COLOR	PKG. QTY.
41101	22-16 GA.	GRAY	100
41103	22-14 GA.	BLUE	100
41203	18-14 GA.	ORANGE	100
41205	18-10 GA.	YELLOW	100
41305	18-8 GA.	RED	100

Specialty Connectors: Vinyl with Skirt

CAT NO:	WIRE RANGE	COLOR	PKG. QTY.
41132	22-10 GA.	YELLOW	100
41134	18-10 GA.	RED	100
41136	14-8 GA.	GRAY	100
41138	12-6 GA.	BLUE	50

Specialty Connectors: Winged Wire Nuts



41146

CAT NO:	WIRE RANGE	COLOR	PKG. QTY.
41142	22-14 GA.	TAN	100
41144	22-12 GA.	YELLOW	100
41146	18-6 GA.	RED	100
41148	GROUNDING CONNECTOR	GREEN	50

Specialty Connectors: Combination with Flexible Skirt

CAT NO:	WIRE RANGE	COLOR	PKG. QTY.
41152	22-12 GA.	ORANGE/BLUE	100
41154	18-12 GA.	RED/YELLOW	100
41156	14-6 GA.	BLUE/GRAY	50

41152



41154



41156



Heat Shrink Tubing Guide



	Thin Wall	Low Temp. Thin Wall	Dual Wall	High Ratio Dual Wall
Shrink Ratio	2:1	2:1	3:1	4:1
Description	A flexible, non-adhesive lined general purpose tubing	A flexible non-adhesive lined general purpose tubing with a lower shrink temperature. Ideal for sensitive electronic applications	A flexible, adhesive lined tubing that provides a water-tight gas-tight seal for connectors and splices	A semi-rigid adhesive lined tubing that accommodates a wide variety of connector shapes and configurations
Colors Available	Black, Red, Clear, Blue, Green, White, Yellow	Black	Black, Red, Clear, Blue, Green, White, Yellow	Black & Clear
Diameters Available	3/64" – 4"	3/64" – 1"	1/8" – 1 1/2"	.225", .293", .427", .700"
Lengths Available	Bulk Spools, Small Spool, 48", 12", 6", 8" Disk Packs, & Special Lengths	Bulk Spools, Small Spool, 48", 12", 6" & Special Lengths	48", 12", 6" & Special Lengths	48", 12", 6" & Special Lengths
MIL-SPEC	MIL-DTL-23053/5C	MIL-DTL-23053/5C Class 1 & 3	MIL-DTL-23053/4 Class 3	MIL-DTL-23053/4 Class 3
UL Listed	UL224-VW-1 (Except Clear)	UL224-VW-1	-	UL File-E85381
Note: Additional Specifications on pages 39 & 40				

**Semi-Rigid
Dual Wall**

2.5:1

A semi-rigid, adhesive lined tubing that provides a water-tight gas-tight seal for connectors and splices

Black & Red
Color-Coded By Size

1/8" – 1"
1.5", 2"

48", 12", 6"
& Special Lengths

MIL-DTL-23053/4
Class I

UL File E157227

**Commercial
Heavy Wall**

3:1

A rigid, adhesive lined tubing ideal for lighter industrial and transportation applications

Black & Red

.40", .75", 1.1",
.75", 1.1", 1.5",
2", 2.7", 3.5", 4.7"

48", 12", 6", 1.5"
& Special Lengths

-

-

**Mil-Spec
Heavy Wall**

3:1

A rigid, adhesive lined tubing with a high flame resistance suitable for direct burial. Ideal for heavy duty applications

Black & Red

.30", .40", .50",
1.75", 2.75", 3.5"

48", 12", 6", 1.5"
& Special Lengths

MIL-DTL-23053/15

UL 486 B&D

**High Ratio
Heavy Wall**

6:1

A rigid, adhesive lined tubing with high shrink ratio to accommodate a wide variety of connector shapes and configurations

Black

.75", 1.3",

48", 12", & 6"
& Special Lengths

-

-

Heavy Wall Heat Shrink Tubing

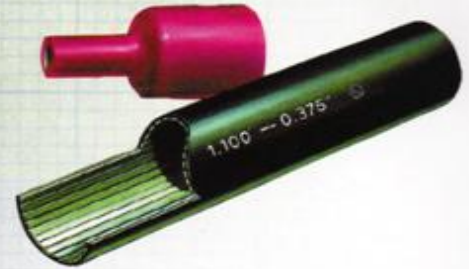

Heavy Wall MIL-SPEC Heat Shrink Tubing with Sealant

- For maximum protection in the harshest environments
- Rigid heavy wall with a 3:1 shrink ratio provides the highest strain relief, abrasion and corrosion resistance
- Flame retardant heavy wall tubing meets MIL Spec 23053/15 Class 1 requirements for flame retardancy
- UL listed 486-D Standard, and CSA certified for direct burial applications

48"	12"	6"	1 1/2"	I.D. IN INCHES		COLOR	WIRE RANGE	MAX. WALL THICKNESS
				EXP.	REC.			
21948	21912	21906		.300	.100	BLACK	18-14 GA.	.060"
21048	21012	21006		.300	.100	RED	18-14 GA.	.060"
21148	21112	21106		.400	.150	BLACK	14-6 GA.	.070"
21848	21812	21806		.400	.150	RED	14-6 GA.	.070"
20548	20512	20506	20501	.510	.160	BLACK	12-4 GA.	.080"
20548R	20512R	20506R	20501R	.510	.160	RED	12-4 GA.	.080"
21248	21212	21206	21201	.750	.220	BLACK	8-1 GA.	.090"
21348	21312	21306	21301	.750	.220	RED	8-1 GA.	.090"
21448	21412	21406	21401	1.10	.375	BLACK	2-4/0	.120"
21548	21512	21506	21501	1.10	.375	RED	2-4/0	.120"
21648	21612	21606		1.50	.500	BLACK	4/0-400MCM	.160"
20648	20612	20606		1.50	.500	RED	4/0-400MCM	.160"
21748	21712	21706		2.00	.750	BLACK	500-1000MCM	.160"
20748	20712	20706		2.00	.750	RED	500-1000MCM	.160"
20148	20112			2.70	.870	BLACK	600-1000MCM	.160"
20248	20212			3.50	1.20	BLACK	800-1300MCM	.160"
20348	20312			4.70	1.60	BLACK	1300-2300MCM	.170"

Please contact factory for additional cut lengths in any size.

Heavy Wall Commercial Grade Heat Shrink Tubing with Sealant

- Rigid 3:1 shrink ratio commercial grade tubing for lighter duty applications
- Provides excellent strain relief as well as high abrasion and corrosion resistance



48"	12"	6"	1 1/2"	I.D. IN INCHES		COLOR	WIRE RANGE	MAX. WALL THICKNESS
				EXP.	REC.			
27501-48	27501-12	27501-6		.400	.150	BLACK	14-6 GA.	.080"
27501R-48	27501R-12	27501R-6		.400	.150	RED	14-6 GA.	.080"
27502-48	27502-12	27502-6	27502-1.5	.750	.220	BLACK	8-1 GA.	.080"
27502R-48	27502R-12	27502R-6	27502R-1.5	.750	.220	RED	8-1 GA.	.080"
27503-48	27503-12	27503-6	27503-1.5	1.10	.400	BLACK	2-4/0	.080"
27503R-48	27503R-12	27503R-6	27503R-1.5	1.10	.400	RED	2-4/0	.080"
27505-48	27505-12	27505-6		1.50	.500	BLACK	4/0-400MCM	.080"
27505R-48	27505R-12	27505R-6		1.50	.500	RED	4/0-400MCM	.080"
27507-48	27507-12	27507-6		2.00	.750	BLACK	500-1000MCM	.080"
27507R-48	27507R-12	27507R-6		2.00	.750	RED	500-1000MCM	.080"

Please contact factory for additional cut lengths in any size.

High-Ratio Heavy Wall Heat Shrink Tubing with Sealant

- Extremely versatile 6:1 shrink ratio can accommodate a wide variety of connector shapes and configurations
- Rigid heavy wall and thermoplastic adhesive lining provides a gas-tight, water-tight seal for the toughest applications



48"	12"	6"	I.D. IN INCHES		COLOR	WIRE RANGE	MAX. WALL THICKNESS
			EXP.	REC.			
27100-48	27100-12	27100-6	.750	.125	BLACK	14-1 GA.	.123"
27101-48	27101-12	27101-6	1.30	.220	BLACK	8-4/0	.135"
27102-48	27102-12	27102-6	1.75	.290	BLACK	2-750MCM	.140"
27103-48	27103-12	27103-6	2.00	.330	BLACK	1/0-1000MCM	.170"
27104-48	27104-12	27104-6	2.75	.460	BLACK	3/0-1200MCM	.190"
27105-48	27105-12	27105-6	3.50	.673	BLACK	500-1300MCM	.170"

Please contact factory for additional cut lengths in any size.

Heavy Wall Heat Shrink Tubing – Railless Repair Sleeves with Sealant

- A wraparound 3:1 shrink ratio insulation that easily installs in repair and splice applications
- No need to shut down equipment or disconnect electrical connection to environmentally protect application



36"	12"	I.D. IN INCHES		COLOR	WIRE RANGE	MAX. WALL THICKNESS
		EXP.	REC.			
27201-36	27201-12	1.20	.240	BLACK	8-3/0	.080"
27202-36	27202-12	1.80	.600	BLACK	2/0-400MCM	.080"
27203-36	27203-12	2.70	.950	BLACK	400-1000MCM	.080"
27204-36	27204-12	3.60	1.30	BLACK	1000-2000MCM	.080"
27205-36	27205-12	4.95	1.65	BLACK	Multiple Conductor	.080"
27206-36	27206-12	6.75	2.50	BLACK	Multiple Conductor	.080"

Heavy Wall Heat Shrink Tubing – End Caps with Sealant

- Quick and effective method for sealing cable, pipe and conduit ends
- Superior resistance to weathering and moisture contamination
- 3:1 shrink ratio



CAT NO:	LENGTH	I.D. IN INCHES		COLOR	MAX. WALL WIRE RANGE	THICKNESS
		EXP.	REC.			
21268	3.50"	.750	.220	BLACK	8-4/0	.135"
21468	4.00"	1.30	.430	BLACK	4/0-500MCM	.140"
21768	4.50"	2.05	.750	BLACK	400-1000MCM	.170"

Heavy Wall Heat Shrink Tubing Kit

- Assortment of our most popular MIL-SPEC heavy wall sizes and colors
- Handy plastic case keeps your tubing organized and stores easily



CATALOG NO: 27095

KIT CONSISTS OF THE FOLLOWING 6" LENGTHS

QUANTITY	ITEM	COLOR	I.D. IN INCHES	
			EXP.	REC.
10	21106	BLACK	.400	.150
10	21806	RED	.400	.150
4	21206	BLACK	.750	.220
4	21306	RED	.750	.220
4	21406	BLACK	1.10	.375
4	21506	RED	1.10	.375



Dual Wall Heat Shrink Tubing with Sealant: Black

- A flexible alternative to heavy wall tubing for light duty applications
- Provides environmental and flame retardant protection for electrical and electronic connections
- Ideal for a variety of applications including automotive, truck, and marine harnesses

BLACK

48"	12"	6"	I.D. IN INCHES		WIRE RANGE	MAX. WALL THICKNESS
			EXP.	REC.		
29004-48	29004-12	29004-6	1/8" (.125)	.040	30-18 GA.	.040"
29005-48	29005-12	29005-6	3/16" (.187)	.060	20-14 GA.	.040"
29006-48	29006-12	29006-6	1/4" (.250)	.080	18-10 GA.	.040"
29008-48	29008-12	29008-6	3/8" (.375)	.125	12-6 GA.	.060"
29009-48	29009-12	29009-6	1/2" (.500)	.160	8-4 GA.	.070"
29010-48	29010-12	29010-6	3/4" (.750)	.250	4-2/0	.070"
29011-48	29011-12	29011-6	1" (1.00)	.320	2-4/0	.100"
29012-48	29012-12	29012-6	1 1/4" (1.25)	.416	1-250MCM	.100"
29013-48	29013-12	29013-6	1 1/2" (1.50)	.510	2/0-350MCM	.100"

Additional cut lengths are available in all sizes. Consult factory for details.

Dual Wall Heat Shrink Tubing with Sealant: Clear

- Clear tubing allows for visual inspection of underlying material

CLEAR

48"	12"	6"	I.D. IN INCHES		WIRE RANGE	MAX. WALL THICKNESS
			EXP.	REC.		
29004C-48	29004C-12	29004C-6	1/8" (.125)	.040	30-18 GA.	.040"
29005C-48	29005C-12	29005C-6	3/16" (.187)	.060	20-14 GA.	.040"
29006C-48	29006C-12	29006C-6	1/4" (.250)	.080	18-10 GA.	.040"
29008C-48	29008C-12	29008C-6	3/8" (.375)	.125	12-6 GA.	.060"
29010C-48	29010C-12	29010C-6	3/4" (.750)	.250	4-2/0	.070"
29011C-48	29011C-12	29011C-6	1" (1.00)	.320	2-4/0	.100"
29012C-48	29012C-12	29012C-6	1 1/4" (1.25)	.416	1-250MCM	.100"
29013C-48	29013C-12	29013C-6	1 1/2" (1.50)	.510	2/0-350MCM	.100"

Additional cut lengths are available in all sizes. Consult factory for details.



Dual Wall Heat Shrink Tubing with Sealant: Colors

- Provides effective method for color-coding electrical harnesses

COLORS

48"	12"	6"	I.D. IN INCHES		COLOR	WIRE RANGE	MAX. WALL THICKNESS
			EXP.	REC.			
29004(cc)-48	29004(cc)-12	29004(cc)-6	1/8" (.125)	.040	Specify	30-18 GA.	.040"
29005(cc)-48	29005(cc)-12	29005(cc)-6	3/16" (.187)	.060	Specify	20-14 GA.	.040"
29006(cc)-48	29006(cc)-12	29006(cc)-6	1/4" (.250)	.080	Specify	18-10 GA.	.040"
29008(cc)-48	29008(cc)-12	29008(cc)-6	3/8" (.375)	.125	Specify	12-6 GA.	.060"
29009(cc)-48	29009(cc)-12	29009(cc)-6	1/2" (.500)	.160	Specify	8-4 GA.	.070"
29010(cc)-48	29010(cc)-12	29010(cc)-6	3/4" (.750)	.250	Specify	4-2/0	.070"
29011(cc)-48	29011(cc)-12	29011(cc)-6	1" (1.00)	.320	Specify	2-4/0	.100"
29012(cc)-48	29012(cc)-12	29012(cc)-6	1 1/4" (1.25)	.416	Specify	1-250MCM	.100"
29013(cc)-48	29013(cc)-12	29013(cc)-6	1 1/2" (1.50)	.510	Specify	2/0-350MCM	.100"

To determine color, replace (cc) with color suffix listed below:

R RED **BL BLUE** **Y YELLOW** **W WHITE** **G GREEN**

(example: For Blue 1/4" Exp. ID. 6" Length; catalog number is 29006BL-6)

Additional cut lengths are available in all sizes and colors. Consult factory for details.

High-Ratio Dual Wall Heat Shrink Tubing with Sealant: Black

- Extremely versatile 4:1 shrink ratio can accommodate a wide variety of connector shapes and configurations
- Semi-rigid flame retardant tubing that shrinks to 25% of it's original size

BLACK

48"	12"	6"	I.D. IN INCHES		WIRE RANGE	MAX. WALL THICKNESS
			EXP.	REC.		
27601-48	27601-12	27601-6	.225	.050	28-12 GA.	.047"
27602-48	27602-12	27602-6	.293	.065	20-8 GA.	.060"
27603-48	27603-12	27603-6	.427	.095	14-4 GA.	.075"
27604-48	27604-12	27604-6	.700	.175	12-1/0	.095"

Additional cut lengths are available in all sizes. Consult factory for details.

High-Ratio Dual Wall Heat Shrink Tubing with Sealant: Clear

- Extremely versatile 4:1 shrink ratio can accommodate a wide variety of connector shapes and configurations
- Clear semi-rigid tubing allows for visual inspection of underlying material

CLEAR

48"	12"	6"	I.D. IN INCHES		WIRE RANGE	MAX. WALL THICKNESS
			EXP.	REC.		
27601C-48	27601C-12	27601C-6	.225	.050	28-12 GA.	.047"
27602C-48	27602C-12	27602C-6	.293	.065	20-8 GA.	.060"
27603C-48	27603C-12	27603C-6	.427	.095	14-4 GA.	.075"
27604C-48	27604C-12	27604C-6	.700	.175	12-1/0	.095"

Additional cut lengths are available in all sizes. Consult factory for details.

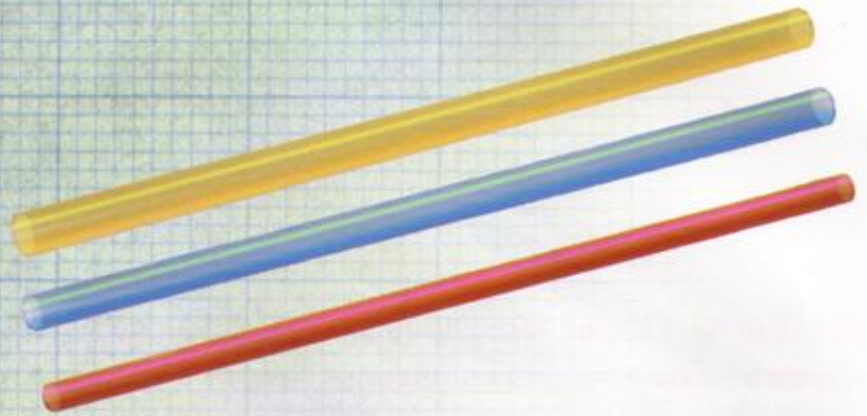

Dual Wall Heat Shrink Tubing with Sealant: Translucent.

- Translucent tubing allows for visual inspection of underlying material
- Color-coded to industry standard
- Semi-rigid 3:1 shrink ratio

NEMA COLOR CODED – TRANSLUCENT

12"	6"	1 1/2"	I.D. IN INCHES		COLOR	WIRE RANGE	MAX. WALL THICKNESS
			EXP.	REC.			
24112	24106	24115	.187" (3/16)	.075	RED	22-18 GA.	.047"
24212	24206	24215	.250" (1/4)	.100	BLUE	16-14 GA.	.047"
24312	24306	24315	.312" (5/16)	.125	YELLOW	12-10 GA.	.050"

Semi-Rigid Dual Wall Heat Shrink Tubing with Meltable Inner Wall: Black.

- Semi-rigid 2.5:1 shrink ratio

BLACK

48"	12"	6"	I.D. IN INCHES		WIRE RANGE	MAX. WALL THICKNESS
			EXP.	REC.		
27804-48	27804-12	27804-6	1/8" (.125)	.030	26-18 GA.	.036"
27805-48	27805-12	27805-6	3/16" (.187)	.060	22-16 GA.	.043"
27806-48	27806-12	27806-6	1/4" (.250)	.080	16-12 GA.	.047"
27808-48	27808-12	27808-6	3/8" (.375)	.130	12-8 GA.	.050"
27809-48	27809-12	27809-6	1/2" (.500)	.195	8-4 GA.	.055"
27810-48	27810-12	27810-6	3/4" (.750)	.313	4-1/0	.065"
27811-48	27811-12	27811-6	1" (1.00)	.400	2-4/0	.075"

Additional cut lengths are available in all sizes. Consult factory for details.



Semi-Rigid Dual Wall Heat Shrink Tubing with Meltable Inner Wall: Color-Coded

- Provides effective method for color-coding electrical harnesses to industry standard
- Semi-rigid 2.5:1 shrink ratio

COLOR-CODED BY SIZE

48"	12"	6"	I.D. IN INCHES		COLOR	WIRE RANGE	MAX. WALL THICKNESS
			EXP.	REC.			
27804BR-48	27804BR-12	27804BR-6	1/8" (.125)	.030	BROWN	26-18 GA.	.036"
27805GY-48	27805GY-12	27805GY-6	3/16" (.187)	.060	GRAY	22-16 GA.	.043"
27806W-48	27806W-12	27806W-6	1/4" (.250)	.080	WHITE	16-12 GA.	.047"
27808R-48	27808R-12	27808R-6	3/8" (.375)	.130	RED	12-8 GA.	.050"
27809BL-48	27809BL-12	27809BL-6	1/2" (.500)	.195	BLUE	8-4 GA.	.055"
27810Y-48	27810Y-12	27810Y-6	3/4" (.750)	.313	YELLOW	4-1/0	.065"
27811-48	27811-12	27811-6	1" (1.00)	.400	BLACK	2-4/0	.075"

Additional cut lengths are available in all sizes. Consult factory for details.

Dual Wall Heat Shrink Tubing Kit

- Assortment of our most popular dual wall sizes and colors
- Handy plastic case keeps your tubing organized and stores easily

CATALOG NO: 29095

KIT CONSISTS OF THE FOLLOWING 6" LENGTHS

QUANTITY	ITEM	COLOR	I.D. IN INCHES	
			EXP.	REC.
25	29006-6	BLACK	.250	.080
25	29006R-6	RED	.250	.080
15	29008-6	BLACK	.375	.125
15	29008R-6	RED	.375	.125
10	29009-6	BLACK	.500	.160
10	29009R-6	RED	.500	.160
5	29010-6	BLACK	.750	.320
5	29010R-6	RED	.750	.320



Kynar Heat Shrink Tubing: Transparent

- The ideal tubing for applications demanding superior chemical solvent resistance
- The transparent tubing allows easy view of connection with a 2:1 shrink ratio
- Excellent cut-through and abrasion resistance
- Highly flame retardant

48"	12"	6"	I.D. IN INCHES		WIRE RANGE	MAX. WALL THICKNESS
			EXP.	REC.		
26404-48	26404-12	26404-6	1/8" (.125)	.062	24-20 GA.	.025"
26405-48	26405-12	26405-6	3/16" (.187)	.093	22-18 GA.	.025"
26406-48	26406-12	26406-6	1/4" (.250)	.125	16-14 GA.	.030"
26408-48	26408-12	26408-6	3/8" (.375)	.187	12-10 GA.	.030"
26409-48	26409-12	26409-6	1/2" (.500)	.250	8-6 GA.	.030"
26410-48	26410-12	26410-6	3/4" (.750)	.375	6-1/0	.045"
26411-48	26411-12	26411-6	1" (1.00)	.500	1-3/0	.050"



Thin Wall Heat Shrink Tubing: Black

- Outstanding tubing for light duty applications
- Effective for wire bundling, abrasion resistance, and strain relief

BLACK

BULK SPOOL	SMALL SPOOL				I.D. IN INCHES		MAX. WALL THICKNESS
		48"	12"	6"	EXP.	REC.	
26001-BRL	26001-600 (50')	26001-48	26001-12	26001-6	3/64" (.046)	.023	.016"
26002-BRL	26002-600 (50')	26002-48	26002-12	26002-6	1/16" (.063)	.031	.017"
26003-BRL	26003-600 (50')	26003-48	26003-12	26003-6	3/32" (.093)	.046	.020"
26004-BRL	26004-600 (50')	26004-48	26004-12	26004-6	1/8" (.125)	.062	.020"
26005-BRL	26005-600 (50')	26005-48	26005-12	26005-6	3/16" (.187)	.093	.020"
26006-BRL	26006-600 (50')	26006-48	26006-12	26006-6	1/4" (.250)	.125	.025"
26007-BRL	26007-600 (50')	26007-48	26007-12	26007-6	5/16" (.312)	.156	.025"
26008-BRL	26008-600 (50')	26008-48	26008-12	26008-6	3/8" (.375)	.187	.025"
26009-BRL	26009-600 (50')	26009-48	26009-12	26009-6	1/2" (.500)	.250	.025"
26010-BRL	26010-300 (25')	26010-48	26010-12	26010-6	3/4" (.750)	.375	.030"
26011-BRL	26011-300 (25')	26011-48	26011-12	26011-6	1" (1.000)	.500	.035"
26013-BRL	26013-300 (25')	26013-48	26013-12	26013-6	1 1/2" (1.500)	.750	.040"
26014-BRL	26014-300 (25')	26014-48	26014-12	26014-6	2" (2.000)	1.00	.045"
26015-BRL		26015-48	26015-12	26015-6	3" (3.000)	1.50	.050"
26016-BRL		26016-48	26016-12	26016-6	4" (4.000)	2.00	.055"

Additional cut lengths are available in all sizes. Consult factory for details and bulk spool put-ups.

Thin Wall Heat Shrink Tubing: Clear

- Clear tubing allows for visual inspection of underlying material

CLEAR

BULK SPOOL	SMALL SPOOL				I.D. IN INCHES		MAX. WALL THICKNESS
		48"	12"	6"	EXP.	REC.	
26001C-BRL	26001C-600 (50')	26001C-48	26001C-12	26001C-6	3/64" (.046)	.023	.016"
26002C-BRL	26002C-600 (50')	26002C-48	26002C-12	26002C-6	1/16" (.063)	.031	.017"
26003C-BRL	26003C-600 (50')	26003C-48	26003C-12	26003C-6	3/32" (.093)	.046	.020"
26004C-BRL	26004C-600 (50')	26004C-48	26004C-12	26004C-6	1/8" (.125)	.062	.020"
26005C-BRL	26005C-600 (50')	26005C-48	26005C-12	26005C-6	3/16" (.187)	.093	.020"
26006C-BRL	26006C-600 (50')	26006C-48	26006C-12	26006C-6	1/4" (.250)	.125	.025"
26007C-BRL	26007C-600 (50')	26007C-48	26007C-12	26007C-6	5/16" (.312)	.156	.025"
26008C-BRL	26008C-600 (50')	26008C-48	26008C-12	26008C-6	3/8" (.375)	.187	.025"
26009C-BRL	26009C-600 (50')	26009C-48	26009C-12	26009C-6	1/2" (.500)	.250	.025"
26010C-BRL	26010C-300 (25')	26010C-48	26010C-12	26010C-6	3/4" (.750)	.375	.030"
26011C-BRL	26011C-300 (25')	26011C-48	26011C-12	26011C-6	1" (1.000)	.500	.035"
26013C-BRL	26013C-300 (25')	26013C-48	26013C-12	26013C-6	1 1/2" (1.500)	.750	.040"
26014C-BRL	26014C-300 (25')	26014C-48	26014C-12	26014C-6	2" (2.000)	1.00	.045"
26015C-BRL		26015C-48	26015C-12	26015C-6	3" (3.000)	1.50	.050"
26016C-BRL		26016C-48	26016C-12	26016C-6	4" (4.000)	2.00	.055"

Additional cut lengths are available in all sizes. Consult factory for details and bulk spool put-ups.

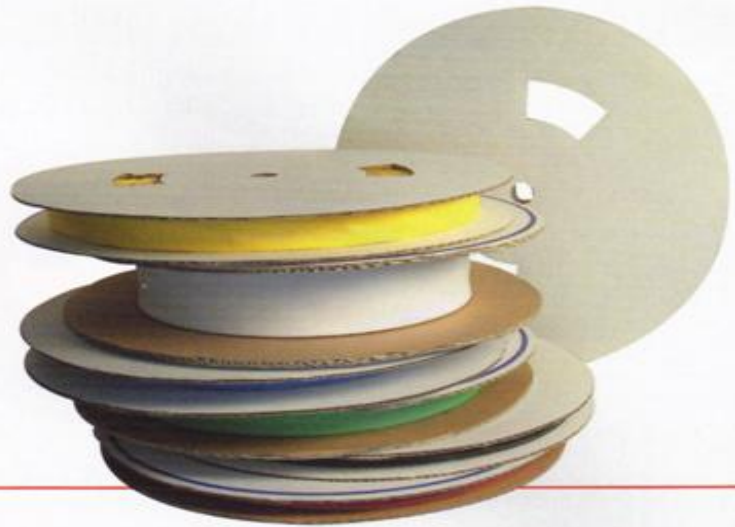

Thin Wall Heat Shrink Tubing: Colors

- Provides flexible method for color-coding electrical harnesses

COLORS

BULK SPOOL	SMALL SPOOL	48"	12"	6"	I.D. IN INCHES		MAX. WALL THICKNESS
					EXP.	REC.	
26001(cc)-BRL	26001(cc)-600 (50')	26001(cc)-48	26001(cc)-12	26001(cc)-6	3/64" (.046)	.023	.016"
26002(cc)-BRL	26002(cc)-600 (50')	26002(cc)-48	26002(cc)-12	26002(cc)-6	1/16" (.063)	.031	.017"
26003(cc)-BRL	26003(cc)-600 (50')	26003(cc)-48	26003(cc)-12	26003(cc)-6	3/32" (.093)	.046	.020"
26004(cc)-BRL	26004(cc)-600 (50')	26004(cc)-48	26004(cc)-12	26004(cc)-6	1/8" (.125)	.062	.020"
26005(cc)-BRL	26005(cc)-600 (50')	26005(cc)-48	26005(cc)-12	26005(cc)-6	3/16" (.187)	.093	.020"
26006(cc)-BRL	26006(cc)-600 (50')	26006(cc)-48	26006(cc)-12	26006(cc)-6	1/4" (.250)	.125	.025"
26007(cc)-BRL	26007(cc)-600 (50')	26007(cc)-48	26007(cc)-12	26007(cc)-6	5/16" (.312)	.156	.025"
26008(cc)-BRL	26008(cc)-600 (50')	26008(cc)-48	26008(cc)-12	26008(cc)-6	3/8" (.375)	.187	.025"
26009(cc)-BRL	26009(cc)-600 (50')	26009(cc)-48	26009(cc)-12	26009(cc)-6	1/2" (.500)	.250	.025"
26010(cc)-BRL	26010(cc)-300 (25')	26010(cc)-48	26010(cc)-12	26010(cc)-6	3/4" (.750)	.375	.030"
26011(cc)-BRL	26011(cc)-300 (25')	26011(cc)-48	26011(cc)-12	26011(cc)-6	1" (1.000)	.500	.035"
26013(cc)-BRL	26013(cc)-300 (25')	26013(cc)-48	26013(cc)-12	26013(cc)-6	1 1/2" (1.500)	.750	.040"
26014(cc)-BRL	26014(cc)-300 (25')	26014(cc)-48	26014(cc)-12	26014(cc)-6	2" (2.000)	1.00	.045"
26015(cc)-BRL		26015(cc)-48	26015(cc)-12	26015(cc)-6	3" (3.000)	1.50	.050"
26016(cc)-BRL		26016(cc)-48	26016(cc)-12	26016(cc)-6	4" (4.000)	2.00	.055"

To determine color, replace (cc) with color suffix listed below:

(example: For Blue 1/4" Exp. ID. 6" Length; catalog number is 26006BL-6)

Additional cut lengths are available in all sizes and colors. Consult factory for details.



Low Shrink Temperature Thin Wall Heat Shrink Tubing: Black

- Ideal for use with sensitive electronic connections

BLACK

BULK SPOOL	SMALL SPOOL	48"	12"	6"	I.D. IN INCHES		MAX. WALL THICKNESS
					EXP.	REC.	
26301-BRL	26301-600 (50')	26301-48	26301-12	26301-6	3/64" (.046)	.023	.016"
26302-BRL	26302-600 (50')	26302-48	26302-12	26302-6	1/16" (.063)	.031	.017"
26303-BRL	26303-600 (50')	26303-48	26303-12	26303-6	3/32" (.093)	.046	.020"
26304-BRL	26304-600 (50')	26304-48	26304-12	26304-6	1/8" (.125)	.062	.020"
26305-BRL	26305-600 (50')	26305-48	26305-12	26305-6	3/16" (.187)	.093	.020"
26306-BRL	26306-600 (50')	26306-48	26306-12	26306-6	1/4" (.250)	.125	.025"
26307-BRL	26307-600 (50')	26307-48	26307-12	26307-6	5/16" (.312)	.156	.025"
26308-BRL	26308-600 (50')	26308-48	26308-12	26308-6	3/8" (.375)	.187	.025"
26309-BRL	26309-600 (50')	26309-48	26309-12	26309-6	1/2" (.500)	.250	.025"
26310-BRL	26310-300 (25')	26310-48	26310-12	26310-6	3/4" (.750)	.375	.030"
26311-BRL	26311-300 (25')	26311-48	26311-12	26311-6	1" (1.000)	.500	.035"

Additional cut lengths are available in all sizes. Consult factory for details and bulk spool put-ups.



Thin Wall Heat Shrink Tubing: 8' Disk Packs

- Convenient dispenser pack allows for easy storage and cutting eliminating waste
- Attractive packaging and descriptive labels perfect for showroom displays

BLACK CAT NO:	I.D. IN INCHES		MAX. WALL THICKNESS
	EXP.	REC.	
28101	3/64"	(.046)	.023
28102	1/16"	(.063)	.031
28103	3/32"	(.093)	.046
28104	1/8"	(.125)	.062
28105	3/16"	(.187)	.093
28106	1/4"	(.250)	.125
28107	5/16"	(.312)	.156
28108	3/8"	(.375)	.187
28109	1/2"	(.500)	.250
28110	3/4"	(.750)	.375
28111	1"	(1.000)	.500

Thin Wall Heat Shrink Tubing: 8' Disk Packs

Available in three colors to NEMA color-code standard to easily and correctly identify connections

NEMA COLOR CODED		I.D. IN INCHES		MAX. WALL THICKNESS
CAT NO:	COLOR	EXP	REC.	
28115	RED	3/16"	(.187)	.093
28116	BLUE	1/4"	(.250)	.125
28117	YELLOW	5/16"	(.312)	.156

Thin Wall Heat Shrink Tubing Kit

- Assortment of our most popular thin wall sizes and colors
- Handy plastic case keeps your tubing organized and stores easily



CATALOG NO: 28005

KIT CONSISTS OF THE FOLLOWING 6" LENGTHS QUANTITY	ITEM	COLOR	I.D. IN INCHES		MAX. WALL THICKNESS
			EXP	REC.	
30	26005-6	BLACK	3/16"	(.187)	.093
28	26006W-6	WHITE	1/4"	(.250)	.125
20	26008R-6	RED	3/8"	(.375)	.125
14	26009-6	BLACK	1/2"	(.500)	.250
6	26010W-6	WHITE	3/4"	(.750)	.375

HEAT-SHRINK TUBING SPECIFICATION

SPECIFICATION	HEAVY WALL	HEAVY WALL-Commercial Grade	6:1 HIGH RATIO
UL MIL SPEC. CSA	UL 486 B&D MIL-DTL-23053/15 MEETS C22.2 NO.198.2	- - -	- - -
Continuous Operating Temperature Minimum Shrink Temperature	-55° C to 110° C 120° C	-55° C to 110° C 120° C	-55° C to 110° C 120° C
Tensile Strength Heat Shock (No Cracking or Flowing) Elongation	2100 psi 4 Hours @ 225° C 600%	2100 psi 4 Hours @ 225° C 550%	2100 psi 4 Hours @ 225° C 600%
Low Temp. Flexibility (No Cracking) Longitudinal Change Flame Retarded	4 Hours @ -55° C 1%,-10% Yes	4 Hours @ -55° C - No	4 Hours @ -55° C 1%,-10% No
Dielectric Strength Volume Resistivity	500 V/Mil 10E16 ohm-cm	500 V/Mil 10E16 ohm-cm	500 V/Mil 10E16 ohm-cm
Corrosion Resistance Fungis Resistance Fluid Resistance	Non-Corrosive Non-Nutriant Excellent	Non-Corrosive Non-Nutriant Excellent	Non-Corrosive Non-Nutriant Excellent
SPECIFICATION	REPAIR SLEEVES	END CAPS	
UL MIL-SPEC. CSA	- - -	- - -	
Continuous Operating Temperature Minimum Shrink Temperature	-55° C to 110° C 120° C	-55° C to 110° C 120° C	
Tensile Strength Heat Shock (No Cracking or Flowing) Elongation	2700 psi 4 Hours @ 225° C 600%	2100 psi 4 Hours @ 225° C 600%	
Low Temp. Flexibility (No Cracking) Longitudinal Change Flame Retarded	- - No	4 Hours @ -55° C - Yes	
Dielectric Strength Volume Resistivity	700 V/Mil 1.9E18 ohm-cm	500 V/Mil 10E16 ohm-cm	
Corrosion Resistance Fungis Resistance Fluid Resistance	Non-Corrosive No Growth Excellent	Non-Corrosive Non-Nutriant Excellent	

HEAT-SHRINK TUBING SPECIFICATIONS (cont.)

SPECIFICATION	DUAL WALL	HIGH RATIO DUAL WALL	SEMI-RIGID DUAL WALL
UL MIL SPEC. CSA	- MIL-DTL-23053/4, Class 3 -	UL FILE-E85381 - -	UL FILE-E157227 MIL-DTL-23053/4, Class 1 -
Continuous Operating Temperature Minimum Shrink Temperature	-55° C to 110° C 120° C	-40° C to 130° C 135° C	-55° C to 110° C 135° C
Tensile Strength Heat Shock (No Cracking or Flowing) Elongation	2200 psi 4 Hours @ 250° C 400%	1300 psi 4 Hours @ 225° C 200%	2200 psi 4 Hours @ 250° C 400%
Low Temp. Flexibility (No Cracking) Longitudinal Change Flame Retarded	4 Hours @ -55° C 1%, -15% Jacket Only (Except Clear)	4 Hours @ -40° C 0%, -10% Yes	4 Hours @ -55° C - No
Dielectric Strength Volume Resistivity	600 V/Mil 10E16 ohm-cm	350 V/Mil 10E12 ohm-cm	900 V/Mil 10E15 ohm-cm
Corrosion Resistance Fungis Resistance Fluid Resistance	Non-Corrosive Non-Nutrient Excellent	Non-Corrosive Non-Nutrient Excellent	Non-Corrosive Non-Nutrient Excellent
SPECIFICATION	KYNAR	THIN WALL	LOW TEMP. THIN WALL
UL MIL SPEC. CSA	UL224-VW-1 MIL-DTL-23053/18 Class 1; MIL-DTL-23053/8 CSA FILE LR38227 OFT	UL224-VW-1 MIL-DTL-23053/5C, Class 1 & 3 -	UL224-VW-1 MIL-DTL-23053/5C, Class 1 & 3 -
Continuous Operating Temperature Minimum Shrink Temperature	-55° C to 175° C 175° C	-55° C to 135° C 120° C	-55° C to 135° C 90° C
Tensile Strength Heat Shock (No Cracking or Flowing) Elongation	5500 psi 4 Hours @ 250° C 350%	1500 psi 4 Hours @ 250° C 200%	1500 psi 4 Hours @ 250° C 200%
Low Temp. Flexibility (No Cracking) Longitudinal Change Flame Retarded	4 Hours @ -55° C 0%, -10% YES (UL224-VW-1)	4 Hours @ -55° C 5%, -5% YES (UL224-VW-1)	4 Hours @ -55° C 1%, -15% YES (UL224-VW-1)
Dielectric Strength Volume Resistivity	900 V/Mil 10E14 ohm-cm	600 V/Mil 10E14 ohm-cm	600 V/Mil 10E14 ohm-cm
Corrosion Resistance Fungis Resistance Fluid Resistance	Non-Corrosive No Growth Excellent	Non-Corrosive Non-Nutrient Excellent	Non-Corrosive Non-Nutrient Excellent



Battery Terminals

• Patent pending bi-metal design
(Copper to Copper), (Lead to Lead)

- Exceeds SAE conductivity standard, J163
- Pure tubular copper barrel permits easier crimping and provides a copper to copper connection with the cable

STRAIGHTS

CAT No.:	SIZE	POLARITY	TOOL DIE	QTY. PKG.
15128	4	UNIVERSAL	GRAY J-H	10
15143	1-2	NEGATIVE	PINK H-H	10
15144	1-2	POSITIVE	PINK H-H	10
15163	1/0	NEGATIVE	BLACK E-A	10
15164	1/0	POSITIVE	BLACK E-A	10
15173	2/0	NEGATIVE	ORANGE A-C	10
15174	2/0	POSITIVE	ORANGE A-C	10
15183	3/0	NEGATIVE	PURPLE A-B	10
15184	3/0	POSITIVE	PURPLE A-B	10
15193	4/0	NEGATIVE	YELLOW A-A	10
15194	4/0	POSITIVE	YELLOW A-A	10



15164



15183

RIGHT ELBOWS

CAT No.:	SIZE	POLARITY	TOOL DIE	QTY. PKG.
15263	1/0	NEGATIVE	BLACK E-A	10
15264	1/0	POSITIVE	BLACK E-A	10
15273	2/0	NEGATIVE	ORANGE A-C	10
15274	2/0	POSITIVE	ORANGE A-C	10
15283	3/0	NEGATIVE	PURPLE A-B	10
15284	3/0	POSITIVE	PURPLE A-B	10

LEFT ELBOWS

CAT No.:	SIZE	POLARITY	TOOL DIE	QTY. PKG.
15363	1/0	NEGATIVE	BLACK E-A	10
15364	1/0	POSITIVE	BLACK E-A	10
15373	2/0	NEGATIVE	ORANGE A-C	10
15374	2/0	POSITIVE	ORANGE A-C	10
15383	3/0	NEGATIVE	PURPLE A-B	10
15384	3/0	POSITIVE	PURPLE A-B	10

FLAGS

CAT No.:	SIZE	POLARITY	TOOL DIE	QTY. PKG.
15463	1/0	NEGATIVE	BLACK E-A	10
15464	1/0	POSITIVE	BLACK E-A	10
15473	2/0	NEGATIVE	ORANGE A-C	10
15474	2/0	POSITIVE	ORANGE A-C	10
15483	3/0	NEGATIVE	PURPLE A-B	10
15484	3/0	POSITIVE	PURPLE A-B	10

Sand Cast Post Top Battery Terminals

A complete line of battery terminals and accessories designed for fast, easy installation and dependable performance.

All terminals are not created equal! 93% copper terminals are the most conductive sand cast terminals available.

Straights

CAT. NO. LEAD PLATED		CAT. NO. TIN PLATED		CABLE SIZE	POLARITY	TOOL DIE CODES
STANDARD	COLOR CODED	STANDARD	COLOR CODED			
12122	12128	12522	12528	4	UNIVERSAL	GREEN J-H
12140	12143	12540	12543	1-2	NEGATIVE	PINK H-H
12141	12144	12541	12544	1-2	POSITIVE	PINK H-H
12160	12163	12560	12563	1/0	NEGATIVE	BLACK E-A
12161	12164	12561	12564	1/0	POSITIVE	BLACK E-A
12170	12173	12570	12573	2/0	NEGATIVE	ORANGE A-C
12171	12174	12571	12574	2/0	POSITIVE	ORANGE A-C
12180	12183	12580	12583	3/0	NEGATIVE	PURPLE A-B
12181	12184	12581	12584	3/0	POSITIVE	PURPLE A-B
12190	12193	12590	12593	4/0	NEGATIVE	YELLOW A-A
12191	12194	12591	12594	4/0	POSITIVE	YELLOW A-A



12570

Right Elbows

CAT. NO. LEAD PLATED		CAT. NO. TIN PLATED		CABLE SIZE	POLARITY	TOOL DIE CODES
STANDARD	COLOR CODED	STANDARD	COLOR CODED			
12260	12263	12760	12763	1/0	NEGATIVE	BLACK E-A
12261	12264	12761	12764	1/0	POSITIVE	BLACK E-A
12270	12273	12770	12773	2/0	NEGATIVE	ORANGE A-C
12271	12274	12771	12774	2/0	POSITIVE	ORANGE A-C
12280	12283	12780	12783	3/0	NEGATIVE	PURPLE A-B
12281	12284	12781	12784	3/0	POSITIVE	PURPLE A-B



12770

Left Elbows

CAT. NO. LEAD PLATED		CAT. NO. TIN PLATED		CABLE SIZE	POLARITY	TOOL DIE CODES
STANDARD	COLOR CODED	STANDARD	COLOR CODED			
12360	12363	12860	12863	1/0	NEGATIVE	BLACK E-A
12361	12364	12861	12864	1/0	POSITIVE	BLACK E-A
12370	12373	12870	12873	2/0	NEGATIVE	ORANGE A-C
12371	12374	12871	12874	2/0	POSITIVE	ORANGE A-C
12380	12383	12880	12883	3/0	NEGATIVE	PURPLE A-B
12381	12384	12881	12884	3/0	POSITIVE	PURPLE A-B



12870

Flags

CAT. NO. LEAD PLATED		CAT. NO. TIN PLATED		CABLE SIZE	POLARITY	TOOL DIE CODES
STANDARD	COLOR CODED	STANDARD	COLOR CODED			
12460	12463	12960	12963	1/0	NEGATIVE	BLACK E-A
12461	12464	12961	12964	1/0	POSITIVE	BLACK E-A
12470	12473	12970	12973	2/0	NEGATIVE	ORANGE A-C
12471	12474	12971	12974	2/0	POSITIVE	ORANGE A-C
12480	12483	12980	12983	3/0	NEGATIVE	PURPLE A-B
12481	12484	12981	12984	3/0	POSITIVE	PURPLE A-B
12490	12493	12990	12993	4/0	NEGATIVE	YELLOW A-A
12491	12494	12991	12994	4/0	POSITIVE	YELLOW A-A



12970

Stud Top Battery Terminals

Professional Crimp Tools
(94284-BM Page 66 & 67)



Power Terminals – Tin Plated

CAT. NO. STANDARD	CAT. NO. COLOR CODED	CABLE SIZE	POLARITY	TOOL DIE CODES
13922	13928	4	UNIVERSAL	GRAY J-H
13952	13958	1-2	UNIVERSAL	PINK H-H
13962	13968	1/0	UNIVERSAL	BLACK E-A
13972	13978	2/0	UNIVERSAL	ORANGE A-C
13982	13988	3/0	UNIVERSAL	PURPLE A-B
13992	13998	4/0	UNIVERSAL	YELLOW A-A



13972

Power Splice (Flag)-Tin Plated

CAT. NO. STANDARD	CAT. NO. COLOR CODED	CABLE SIZE	POLARITY	TOOL DIE CODES
13562	13568	1/0	UNIVERSAL	BLACK E-A
13572	13578	2/0	UNIVERSAL	ORANGE A-C
13582	13588	3/0	UNIVERSAL	PURPLE A-B
13592	13598	4/0	UNIVERSAL	YELLOW A-A



13572

Cast Terminals-Straights

CAT. NO. LEAD PLATED		CAT. NO. TIN PLATED		CABLE SIZE	POLARITY	TOOL DIE CODE
STANDARD	COLOR CODED	STANDARD	COLOR CODED			
13322	13328	13122	13128	4	UNIVERSAL	GREEN J-H
13352	13358	13152	13158	1-2	UNIVERSAL	PINK H-
13362	13368	13162	13168	1/0	UNIVERSAL	BLACK E-A
13372	13378	13172	13178	2/0	UNIVERSAL	ORANGE A-C
13382	13388	13182	13188	3/0	UNIVERSAL	PURPLE A-
13392	13398	13192	13198	4/0	UNIVERSAL	YELLOW A-A



13372

Cast Terminals-Splices (Flags)

CAT. NO. LEAD PLATED		CAT. NO. TIN PLATED		CABLE SIZE	CABLE POLARITY	TOOL DIE CODES
STANDARD	COLOR CODED	STANDARD	COLOR CODED			
13862	13868	13262	13268	1/0	UNIVERSAL	BLACK E-A
13872	13878	13272	13278	2/0	UNIVERSAL	ORANGE A-C
13882	13888	13282	13288	3/0	UNIVERSAL	PURPLE A-B
13892	13898	13292	13298	4/0	UNIVERSAL	YELLOW A-A



13272

Lugs and Splices



Heavy Duty Power Lugs



91767

CAT. NO	CABLE SIZE	STUD SIZE	TOOL DIE CODES	QTY. PKG.
91705	8	1/4"	RED M-K	10
91706	8	5/16"	RED M-K	10
91707	8	3/8"	RED M-K	10
91709	8	1/2"	RED M-K	10
91715	6	1/4"	BLUE K-K	10
91716	6	5/16"	BLUE K-K	10
91717	6	3/8"	BLUE K-K	10
91719	6	1/2"	BLUE K-K	10
91725	4	1/4"	GRAY J-H	10
91726	4	5/16"	GRAY J-H	10
91727	4	3/8"	GRAY J-H	10
91729	4	1/2"	GRAY J-H	10
91745	1-2	1/4"	PINK H-H	10
91746	1-2	5/16"	PINK H-H	10
91747	1-2	3/8"	PINK H-H	10
91749	1-2	1/2"	PINK H-H	10
91756	1/0	5/16"	BLACK E-A	10
91757	1/0	3/8"	BLACK E-A	10
91759	1/0	1/2"	BLACK E-A	10
91766	2/0	5/16"	ORANGE A-C	10
91767	2/0	3/8"	ORANGE A-C	10
91769	2/0	1/2"	ORANGE A-C	10
91776	3/0	5/16"	PURPLE A-B	10
91777	3/0	3/8"	PURPLE A-B	10
91779	3/0	1/2"	PURPLE A-B	10
91786	4/0	5/16"	YELLOW A-A	10
91787	4/0	3/8"	YELLOW A-A	10
91789	4/0	1/2"	YELLOW A-A	10

Heavy Duty Power Splices



91870

CAT. NO. TIN PLATED	CABLE SIZE	TOOL DIE CODES	QTY. PKG.
91800	8	RED M-K	10
91810	6	BLUE K-K	10
91820	4	GRAY J-H	10
91840	1-2	PINK H-H	10
91850	1/0	BLACK E-A	10
91860	2/0	ORANGE A-C	10
91870	3/0	PURPLE A-B	10
91880	4/0	YELLOW A-A	10

Light Duty Lugs and Splices

Starter Lugs

CAT. NO. UNPLATED	CAT. NO. TIN PLATED	CABLE SIZE	STUD SIZE	TOOL DIE CODES	QTY. PKG.
91104	91004	8	#10	RED	10
91105	91005	8	1/4"	RED	10
91106	91006	8	5/16"	RED	10
91107	91007	8	3/8"	RED	10
91109	91009	8	1/2"	RED	10
91114	91014	6	#10	BLUE M-K	10
91115	91015	6	1/4"	BLUE M-K	10
91116	91016	6	5/16"	BLUE M-K	10
91117	91017	6	3/8"	BLUE M-K	10
91119	91019	6	1/2"	BLUE M-K	10
91124	91024	4	#10	GRAY K-K	10
91125	91025	4	1/4"	GRAY K-K	10
91126	91026	4	5/16"	GRAY K-K	10
91127	91027	4	3/8"	GRAY K-K	10
91129	91029	4	1/2"	GRAY K-K	10
91135	91035	2	1/4"	BROWN J-H	10
91136	91036	2	5/16"	BROWN J-H	10
91137	91037	2	3/8"	BROWN J-H	10
91139	91039	2	1/2"	BROWN J-H	10
91145	91045	1	1/4"	GREEN J-H	10
91146	91046	1	5/16"	GREEN J-H	10
91147	91047	1	3/8"	GREEN J-H	10
91149	91049	1	1/2"	GREEN J-H	10
91155	91055	1/0	1/4"	PINK H-H	10
91156	91056	1/0	5/16"	PINK H-H	10
91157	91057	1/0	3/8"	PINK H-H	10
91159	91059	1/0	1/2"	PINK H-H	10
91165	91065	2/0	1/4"	BLACK E-A	10
91166	91066	2/0	5/16"	BLACK E-A	10
91167	91067	2/0	3/8"	BLACK E-A	10
91169	91069	2/0	1/2"	BLACK E-A	10
91175	91075	3/0	1/4"	ORANGE A-C	10
91176	91076	3/0	5/16"	ORANGE A-C	10
91177	91077	3/0	3/8"	ORANGE A-C	10
91179	91079	3/0	1/2"	ORANGE A-C	10
91185	91085	4/0	1/4"	PURPLE A-B	10
91186	91086	4/0	5/16"	PURPLE A-B	10
91187	91087	4/0	3/8"	PURPLE A-B	10
91189	91089	4/0	1/2"	PURPLE A-B	10



91167

Cable Splices: Tin Plated

CAT. NO.	CABLE SIZE	TOOL DIE CODES	QTY. PKG.
91200	8	RED	10
91210	6	BLUE M-K	10
91220	4	GRAY K-K	10
91230	2	BROWN J-H	10
91240	1	GREEN J-H	10
91250	1/0	PINK H-H	10
91260	2/0	BLACK E-A	10
91270	3/0	ORANGE A-C	10
91280	4/0	PURPLE A-B	10



91260

Yellow Brass Terminals



17180

Lead Plated Straights

CAT. NO.	CABLE SIZE	POLARITY	QTY. PKG.
17112	6	UNIVERSAL	10
17113	3-4	UNIVERSAL	10
17122	1-2	UNIVERSAL	10
17162	1/0	UNIVERSAL	10
17133	1/0	NEGATIVE	10
17132	1/0	POSITIVE	10
17180	2/0-3/0	NEGATIVE	10
17181	2/0-3/0	POSITIVE	10
17128	MARINE TERMINAL	NEGATIVE	10
17129	MARINE TERMINAL	POSITIVE	10



17129

Lead Plated Flags: Split Barrels

CAT. NO.	CABLE SIZE	POLARITY	QTY. PKG.
17120	4	UNIVERSAL	10
17101	1-2	UNIVERSAL	10
17126	1/0	NEGATIVE	10
17125	1/0	POSITIVE	10
17472	2/0	UNIVERSAL	10
17470	2/0	NEGATIVE	10
17471	2/0	POSITIVE	10
17480	2/0-3/0	NEGATIVE	10
17481	2/0-3/0	POSITIVE	10



17471



16016

Lead Plated Emergency Style

CAT. NO.	DESCRIPTION	CABLE SIZE	POLARITY	QTY. PKG.
16016	LIGHT DUTY	6-3/0	UNIVERSAL	10
16018	MEDIUM DUTY	6-3/0	UNIVERSAL	10
16020	HEAVY DUTY	6-3/0	UNIVERSAL	10
16023	SIDE MOUNT	6-3/0	UNIVERSAL	10



16023

Solder Accessories



17900



17901



17902



17903



17904



17905



17906

Solder Slugs Pellets

CAT. NO.	WIRE SIZE	COLOR	QTY. PKG.
17900	4	GRAY	25
17901	2	GREEN	25
17902	1	PINK	25
17903	1/0	BLACK	25
17904	2/0	ORANGE	25
17905	3/0	PURPLE	25
17906	4/0	YELLOW	25
17907	Flux for use with solder slugs		1

Solder-It Paste

CAT. NO.	DESCRIPTION	CONTENTS	QTY. PKG.
17999	SILVER BEARING SOLDER PASTE	7.1 GRAMS	1
17998	ALUMINUM SOLDER PASTE	7.1 GRAMS	1
17996	PLASTIC WELD PASTE - WHITE	10 GRAMS	1
17997	PLASTIC WELD PASTE - BLACK	10 GRAMS	1



Cast Lead Terminals



16012

Emergency Style Terminals

- Quick and simple way to repair battery cable ends
- No crimping tool needed



16022



16032

CAT. NO.	DESCRIPTION	CABLE SIZE	POLARITY
16009	Light duty	8 GA. - 1 GA.	Universal
16012	Standard duty	6 GA. - 3/0	Universal
16060	Standard duty - Black	6 GA. - 3/0	Universal
16061	Standard duty - Red	6 GA. - 3/0	Universal
16022	Heavy duty	1 GA. - 4/0	Universal

Side Post Terminal

- Universal connector for side terminal batteries

CAT. NO.	DESCRIPTION	CABLE SIZE	POLARITY
16032	Side post terminal	6- 2/0	Universal

Marine Terminal

- Converts standard battery post terminals to a marine stud connector
- Allows for easy removal of connector from battery



17138

CAT. NO.	DESCRIPTION	POLARITY
17138	Marine terminal	Negative
17139	Marine terminal	Positive

3-Way Fleet Terminal

- Allows for multiple cable configurations



16035

CAT. NO.	DESCRIPTION	CABLE SIZE	POLARITY
16035	3-Way fleet terminal	1- 4/0	Negative
16036	3-Way fleet terminal	1- 4/0	Positive

Side Terminal Adaptor

- Converts top terminal battery posts to accept side terminal cables
- Available separately or as a pair



16052

CAT. NO.	DESCRIPTION	POLARITY
16050	Side terminal adaptor	Negative
16051	Side terminal adaptor	Positive
16052	Side terminal adaptor set	Negative & Positive

SAFE-MATE™ BATTERY CONNECTORS



63243

Safe-Mate™ Industrial Battery Connectors

CAT. NO. COMPLETE UNIT	CAT.NO. HOUSING	CAT. NO. CONTACT	AMPERAGE RATING	HOUSING COLOR	CABLE SIZE	I.D. CONTACT	COMPLETE UNIT OR HOUSING QTY.	CONTACT QTY.
61813	61811	61812	50	GRAY	6	.221	1	10
61823	61811	61822	50	GRAY	12-10	.136	1	10
62803	62831	62802	175	GRAY	4	.297	1	10
62813	62831	62812	175	GRAY	1-2	.340	1	10
62233	62231	62832	175	RED	1/0	.437	1	10
62333	62331	62832	175	ORANGE	1/0	.437	1	10
62433	62431	62832	175	YELLOW	1/0	.437	1	10
62633	62631	62832	175	BLUE	1/0	.437	1	10
62833	62831	62832	175	GRAY	1/0	.437	1	10
63243	63241	63842	350	RED	2/0	.484	1	10
63443	63441	63842	350	YELLOW	2/0	.484	1	10
63543	63541	63842	350	GREEN	2/0	.484	1	10
63643	63641	63842	350	BLUE	2/0	.484	1	10
63843	63841	63842	350	GRAY	2/0	.484	1	10
63853	63841	63852	350	GRAY	3/0	.578	1	10
63863	63841	63862	350	GRAY	4/0	.641	1	10

Safe-Mate™ Accessories

CAT. NO.	DESCRIPTION	AMPERAGE	COLOR	PKG. QTY.
61004	MOUNTING HANDLE	50	RED	1
62004	MOUNTING HANDLE	175	RED	1
63004	MOUNTING HANDLE	350	RED	1
61007	DUST COVER	50	BLACK	1
62007	DUST COVER	175	BLACK	1
63007	DUST COVER	350	BLACK	1

61007



61004



BATTERY ACCESSORIES

Stud Top: Cross-Over Cable Assemblies



95246

95247

CAT. NO.	LENGTH	CABLE SIZE	POLARITY	PKG. QTY.
95242	8"	1/0	NEGATIVE	1
95243	8"	1/0	POSITIVE	1
95262	16"	1/0	NEGATIVE	1
95263	16"	1/0	POSITIVE	1
95246	8"	2/0	NEGATIVE	1
95247	8"	2/0	POSITIVE	1
95266	16"	2/0	NEGATIVE	1
95267	16"	2/0	POSITIVE	1

Post Top: Cross-Over Cable Assemblies



95342

95901

CAT. NO.	LENGTH	CABLE SIZE	POLARITY	PKG. QTY.
95342	8"	2/0	UNIVERSAL	1
95352	12"	2/0	UNIVERSAL	1

Ground Straps



CAT. NO.	DESCRIPTION	PKG. QTY.
95901	4 GA. GROUND STRAP 12" LENGTH	1
95902	4 GA. GROUND STRAP 18" LENGTH	1

Side Mount Battery Terminals: Tin Plated Copper Terminal



14062

CAT. NO	CABLE SIZE	POLARITY	TOOL DIE CODES
14022	4	UNIVERSAL	GRAY K-K
14032	2	UNIVERSAL	BROWN J-H
14052	1	UNIVERSAL	GREEN J-H
14062	1/0	UNIVERSAL	PINK H-H

Side Mount Bolts



99001

99001L

99002

99013

CAT. NO.	DESCRIPTION	PKG. QTY.
99001	SIDE-MOUNT BOLT, OEM, STEEL, ZINC-PLATED	10
99001L	SIDE-MOUNT BOLT, OEM, STEEL, ZINC PLATED-LONG	10
99002	SIDE-MOUNT BOLT LONG WITH SCREW, STEEL, ZINC-PLATED	10
99013	SIDE-MOUNT BOLT WITH 3/8" ACCESSORY BOLT, BRASS	10

Nut and Bolt

CAT. NO. NUT & BOLT	CAT. NO. NUT ONLY	CAT. NO. BOLT ONLY	DESCRIPTION	PKG. QTY.
99051	99053	99055	5/16-18 x 1 1/4" BOLT & SHOULDER NUT, STEEL, LEAD PLATED	50
99052	99054	99056	5/16-18 x 1 1/4" BOLT & SHOULDER NUT, STEEL, ZINC PLATED	50
99057	99053	99058	5/16-18 x 1 1/2" BOLT & SHOULDER NUT, STEEL, LEAD PLATED	50
99513	99054	99502	5/16-18 x 1 1/2" BOLT & SHOULDER NUT, STEEL, ZINC PLATED	50



Stud Nuts group 31 batteries

CAT. NO.	DESCRIPTION	POLARITY	PKG. QTY.
99003	BLACK AMODEL	NEGATIVE	10
99004	RED AMODEL	POSITIVE	10
99005	STAINLES STEEL	UNIVERSAL	10



Stud to Post Converter Solid Lead

CAT. NO.	DESCRIPTION	POLARITY	PKG. QTY.
99010	CONVERTER	UNIVERSAL	10
99007	SET OF 1 NEGATIVE AND 1 POSITIVE CONVERTER		10



Anti-Corrosion Rings

CAT. NO.	BATTERY TYPE	COLOR/POLARITY	PKG. QTY.
99014	POST TOP	GREEN/NEGATIVE	50
99015	POST TOP	RED/POSITIVE	50
99015S	STUD TOP	GRAY/UNIVERSAL	50
99018	SIDE MOUNT	BLACK/UNIVERSAL	100



99018

Mechanical Flasher

CAT. NO.	PRONGS	AMPERAGE	PKG. QTY.
79900	2	20	1



BATTERY TERMINAL BRUSHES AND BATTERY CARRIERS

BATTERY TERMINAL BRUSHES

Clean and polish corroded battery terminals & posts with FTZ's complete line of battery brushes.

Post & Terminal Brush

94070 **Plastic**
94071 **Steel**

- Two-piece corrosion-resistant brush available in metal or plastic
- Inner circular bristles clean all sides of battery posts
- Tapered top brush cleans battery terminal barrels and clamps

3-Way Post & Terminal Brush

94072

- Three-piece corrosion-resistant brush provides three tools in one
- Inner circular bristles clean battery posts
- Tapered brush cleans battery terminal barrels and clamps
- Large rectangular brush ideal for terminals, cables, and fasteners

Power Drill Post & Terminal Brush

94073
94074
94075

Battery Post Brush
Terminal & Clamp Brush
Terminal & Clamp Brush

- Brushes securely fit in all standard power drills for fast cleaning
- Made with a heavy duty durable injection molded housing

Battery Carriers

FTZ battery carriers make the removal, installation, and transport of batteries quick and easy.

94078

Adjustable battery carrier

- High quality battery carrier for all battery types and sizes
- Comfort grip handles and sidewall pads provide secure and easy battery removal
- Adjustable notch system guarantees proper fit

94079
94080

Scissors style battery carrier with padded grips
Scissors style battery carrier with metal grips

- Fits up through Group 31 batteries
- Padded grips easily and securely used to lift and install batteries

Aerosols

CAT. NO.

DESCRIPTION

PKG. QTY.

99011
99012

TERMINAL CLEANER AND ACID DETECTOR
TERMINAL PROTECTOR

6
6

99011

99012

WIRE AND CABLE

Our copper battery cable and welding cable offer highly conductive flexible connections even in extreme conditions. Our welding cable's extra stranding provides superior flexibility. The battery cable is color-coded for easy identification and selection.

To simplify measuring and cutting, the cable size repeats at one foot intervals.

Battery Cable

- Conforms to SAE J1127 specifications
- Thermoplastic insulation rated at 105°C
- Insulation is color-coded to match correct die code



CAT. NO. BLACK	CAT. NO. RED	CABLE SIZE	# STRANDS / STRAND SIZE	O.D.	AMPERAGE	LENGTH
92121	92121R	4	133/.017	.270	120	50'
92131	92131R	2	133/.023	.345	240	50'
92141	92141R	1	247/.018	.385	300	50'
92151	92151R	1/0	247/.020	.430	360	50'
92161	92161R	2/0	333/.020	.500	450	50'
92171	92171R	3/0	259/.022	.545	540	50'
92181	92181R	4/0	361/.024	.601	540	50'

Welding Cable

- Specially-formulated insulation protects even in the most extreme temperatures and provides superior solvent resistance
- Super-fine stranding insures maximum flexibility and is highly conductive-PVC insulation



CAT. NO. BLACK	CAT. NO. RED	CABLE SIZE	# STRANDS/ STRANDS SIZE	LENGTH
92105	92105R	8	168/.010	50'
92115	92115R	6	266/.010	50'
92125	92125R	4	420/.010	50'
92135	92135R	2	665/.010	50'
92145	92145R	1	836/.010	50'
92155	92155R	1/0	1064/.010	50'
92165	92165R	2/0	1330/.010	50'
92175	92175R	3/0	1666/.010	50'
92185	92185R	4/0	2107/.010	50'

Multi-Conductor Truck and Trailer Cable

CAT. NO.	CONDUCTOR	WIRE SIZE	COLOR	LENGTH
92400	2	14 GA.	GRAY	100'
92401	2	14 GA.	WHITE	100'
92402	2	16 GA.	GRAY	100'
92403	2	16 GA.	WHITE	100'
92404	2	10 GA.	GRAY	100'
92405	2	12 GA.	GRAY	100'
92406	2	12 GA.	WHITE	100'
92407	3	14 GA.	WHITE	100'
92408	3	12 GA.	WHITE	100'
92409	4	14 GA.	BLACK	100'
92410	6	14 GA.	BLACK	100'
92412	7	6/12 GA., 1/10 GA.	BLACK	100'
92413	ABS 7	4/12 GA., 2/10 GA., 1/8 GA.	GREEN	100'



Primary Wire – Type GXL

- Conforms to SAE J1128 specifications
- Chemically cross-linked insulation rated at 125°C

CAT. NO.	CABLE SIZE	LENGTH
92318	18	100'
92316	16	100'
92314	14	100'
92312	12	100'
92310	10	100'



Available colors: Black-BK, Red-R, White-W, Green-G, Brown-BR, Blue-BL, Yellow-Y, Orange-O. Add suffix to above part number when ordering: e.g. 92314-R is red 14 ga. wire.

BK BLACK	R RED	W WHITE	G GREEN
BR BROWN	BL BLUE	Y YELLOW	O ORANGE

FTZ offers a new complete line of nylon cable ties in lengths from 4" to 48" and are available in natural, UV Black and assorted colors in select sizes. Our wide range of cable ties can accommodate bundle diameters from .75" to 15" and provides loop tensile strengths from 18 lbs. to 250 lbs.

CABLE TIES



Standard Cable Ties

CAT. NO.	PKG. QTY.	COLOR	TENSILE STRENGTH	LENGTH	WIDTH	BUNDLE DIAMETER
93110	100	NATURAL	18 LBS.	4.0"	0.10"	.75"
93110M	1000	NATURAL	18 LBS.	4.0"	0.10"	.75"
93210	100	UV BLACK	18 LBS.	4.0"	0.10"	.75"
93210M	1000	UV BLACK	18 LBS.	4.0"	0.10"	.75"
93120	100	NATURAL	40 LBS.	5.7"	0.14"	1.25"
93120M	1000	NATURAL	40 LBS.	5.7"	0.14"	1.25"
93220	100	UV BLACK	40 LBS.	5.7"	0.14"	1.25"
93220M	1000	UV BLACK	40 LBS.	5.7"	0.14"	1.25"
93130	100	NATURAL	50 LBS.	8"	0.19"	2.0"
93130M	1000	NATURAL	50 LBS.	8"	0.19"	2.0"
93230	100	UV BLACK	50 LBS.	8"	0.19"	2.0"
93230M	1000	UV BLACK	50 LBS.	8"	0.19"	2.0"
93150	100	NATURAL	50 LBS.	11.8"	0.19"	3.0"
93150M	1000	NATURAL	50 LBS.	11.8"	0.19"	3.0"
93250	100	UV BLACK	50 LBS.	11.8"	0.19"	3.0"
93250M	1000	UV BLACK	50 LBS.	11.8"	0.19"	3.0"
93160	100	NATURAL	50 LBS.	14.6"	0.19"	4.0"
93160M	1000	NATURAL	50 LBS.	14.6"	0.19"	4.0"
93260	100	UV BLACK	50 LBS.	14.6"	0.19"	4.0"
93260M	1000	UV BLACK	50 LBS.	14.6"	0.19"	4.0"
93170	100	NATURAL	120 LBS.	14.5"	0.30"	4.0"
93170D	500	NATURAL	120 LBS.	14.5"	0.30"	4.0"
93270	100	UV BLACK	120 LBS.	14.5"	0.30"	4.0"
93270D	500	UV BLACK	120 LBS.	14.5"	0.30"	4.0"
93185	100	NATURAL	120 LBS.	28"	0.30"	8.0"
93185D	500	NATURAL	120 LBS.	28"	0.30"	8.0"
93285	100	UV BLACK	120 LBS.	28"	0.30"	8.0"
93285D	500	UV BLACK	120 LBS.	28"	0.30"	8.0"

Heavy Duty Cable Ties

CAT. NO.	PKG. QTY.	COLOR	TENSILE STRENGTH	LENGTH	WIDTH	BUNDLE DIAMETER
93180	100	NATURAL	175 LBS.	25.0"	0.35"	7.0"
93280	100	UV BLACK	175 LBS.	25.0"	0.35"	7.0"
93195	50	NATURAL	175 LBS.	36.5"	0.35"	10.7"
93295	50	UV BLACK	175 LBS.	36.5"	0.35"	10.7"
93199	50	NATURAL	175 LBS.	48.0"	0.35"	15.0"
93299	50	UV BLACK	175 LBS.	48.0"	0.35"	15.0"

Super Heavy Duty Cable Ties

CAT. NO.	PKG. QTY.	COLOR	TENSILE STRENGTH	LENGTH	WIDTH	BUNDLE DIAMETER
93190	100	NATURAL	250 LBS.	22.0"	0.50"	6.0"
93290	100	UV BLACK	250 LBS.	22.0"	0.50"	6.0"
93196	100	NATURAL	250 LBS.	34.0"	0.50"	10.1"
93296	100	UV BLACK	250 LBS.	34.0"	0.50"	10.1"

Colored Cable Ties

CAT. NO.	PKG. QTY.	COLOR	TENSILE STRENGTH	LENGTH	WIDTH	BUNDLE DIAMETER
93110-R	100	RED	18 LBS.	4.0"	0.10"	.75"
93230-R	100	RED	50 LBS.	8"	0.19"	2.0"
93110-GR	100	GREEN	18 LBS.	4.0"	0.10"	.75"
93230-GR	100	GREEN	50 LBS.	8"	0.19"	2.0"
93110-Y	100	YELLOW	18 LBS.	4.0"	0.10"	.75"
93230-Y	100	YELLOW	50 LBS.	8"	0.19"	2.0"
93110-BL	100	BLUE	18 LBS.	4.0"	0.10"	.75"
93230-BL	100	BLUE	50 LBS.	8"	0.19"	2.0"
93110-OR	100	ORANGE	18 LBS.	4.0"	0.10"	.75"
93230-OR	100	ORANGE	50 LBS.	8"	0.19"	2.0"

Mounting Head Cable Ties

CAT. NO.	PKG. QTY.	COLOR	TENSILE STRENGTH	LENGTH	WIDTH	BUNDLE DIAMETER
93310	100	NATURAL	18 LBS.	4.5"	.10"	.62"
93410	100	UV BLACK	18 LBS.	4.5"	.10"	.62"
93320	100	NATURAL	40 LBS.	5.9"	.14"	1.25"
93420	100	UV BLACK	40 LBS.	5.9"	.14"	1.25"
93340	100	NATURAL	50 LBS.	8"	.19"	2"
93440	100	UV BLACK	50 LBS.	8"	.19"	2"
93350	100	NATURAL	50 LBS.	12.6"	.19"	3"
93450	100	UV BLACK	50 LBS.	12.6"	.19"	3"
93380	100	NATURAL	50 LBS.	15"	.19"	4"
93480	100	UV BLACK	50 LBS.	15"	.19"	4"
93390	100	NATURAL	120 LBS.	15"	.30"	4"
93490	100	UV BLACK	120 LBS.	15"	.30"	4"

Push Mount Cable Ties

CAT. NO.	PKG. QTY.	COLOR	TENSILE STRENGTH	LENGTH	WIDTH	BUNDLE DIAMETER
93345	100	NATURAL	50 LBS.	7.9"	.19"	2"
93445	100	UV BLACK	50 LBS.	7.9"	.19"	2"

Releasable Cable Ties

CAT. NO.	PKG. QTY.	COLOR	TENSILE STRENGTH	LENGTH	WIDTH	BUNDLE DIAMETER
93620	100	NATURAL	50 LBS.	5.9"	.30"	1.2"
93720	100	UV BLACK	50 LBS.	5.9"	.30"	1.2"
93640	100	NATURAL	50 LBS.	7.8"	.30"	2"
93740	100	UV BLACK	50 LBS.	7.8"	.30"	2"
93650	100	NATURAL	50 LBS.	10.5"	.30"	3"
93750	100	UV BLACK	50 LBS.	10.5"	.30"	3"

In-line Cable Ties

CAT. NO.	PKG. QTY.	COLOR	TENSILE STRENGTH	LENGTH	WIDTH	BUNDLE DIAMETER
93794	100	UV BLACK	50 LBS.	7.2"	0.35"	1.7"
93795	100	UV BLACK	50 LBS.	10.5"	0.35"	2.7"
93796	100	UV BLACK	50 LBS.	14.1"	0.35"	3.7"

CABLE TIES (Cont.)**Stainless Steel Cable Ties**

CAT. NO.	PKG. QTY.	COLOR	TENSILE STRENGTH	LENGTH	WIDTH	BUNDLE DIAMETER
93804	100	SS Steel	100	8"	.18"	2"
93808	100	302/304	100	14"	.18"	4"
93812	100	302/304	100	20"	.18"	6"
93805	100	SS Steel	100	8"	.30"	2"
93809	100	302/304	100	14"	.30"	4"
93813	100	302/304	100	20"	.30"	8"

Mounting Bases

CAT. NO.	COLOR	LENGTH	WIDTH	HEIGHT	HOLE SIZE	SLOT SIZE	PKG. QTY.
93511	NATURAL	.75"	.75"	.205"	#6	.05"	100
93513	UV BLACK	.75"	.75"	.205"	#6	.05"	100
93510	NATURAL	1.0"	1.0"	.215"	#8	.07"	100
93512	UV BLACK	1.0"	1.0"	.215"	#8	.07"	100
93514	NATURAL	12.0"	2.0"	300"	#6 & #8	.30"	100
93515	UV BLACK	12.0"	2.0"	300"	#6 & #8	.30"	100

Cable Tie Installation Tool

CAT. NO.	COLOR	DESCRIPTION
94400	RED	Installation and cutoff tool for standard cable ties 18-50 lbs

**Cable Tie Kit**

CAT. NO.	KIT INCLUDES:	DESCRIPTION:	QTY. IN KIT
93403	94400	CABLE TIE INSTALLATION TOOL	1
	93230	8" UV BLACK 50 LB. CABLE TIES	50
	93120	5.7" NATURAL 40 LB. CABLE TIES	100
	93510	1" x 1" NATURAL MOUNTING BASES	10



CABLE CLAMPS

Light Duty Nylon Cable Clamps

CAT. NO.	QTY. PER BAG	COLOR	CABLE DIAMETER	HOLE DIAMETER	WIDTH
60301	100	NATURAL	.187" (3/16)	.17"	.37"
60301BK	100	UV BLACK	.187" (3/16)	.17"	.37"
60302	100	NATURAL	.250" (1/4)	.17"	.37"
60302BK	100	UV BLACK	.250" (1/4)	.17"	.37"
60304	100	NATURAL	.375" (3/8)	.17"	.37"
60304BK	100	UV BLACK	.375" (3/8)	.17"	.37"
60306	100	NATURAL	.500" (1/2)	.17"	.37"
60306BK	100	UV BLACK	.500" (1/2)	.17"	.37"



60306



60306BK

Heavy Duty Nylon Cable Clamps

CAT. NO.	QTY. PER BAG	COLOR	CABLE DIAMETER	HOLE DIAMETER	WIDTH
60402	100	NATURAL	.250" (1/4)	.20"	.50"
60402BK	100	UV BLACK	.250" (1/4)	.20"	.50"
60404	100	NATURAL	.375" (3/8)	.20"	.50"
60404BK	100	UV BLACK	.375" (3/8)	.20"	.50"
60406	100	NATURAL	.500" (1/2)	.20"	.50"
60406BK	100	UV BLACK	.500" (1/2)	.20"	.50"
60408	100	NATURAL	.750" (3/4)	.20"	.50"
60408BK	100	UV BLACK	.750" (3/4)	.20"	.50"
60410	100	NATURAL	1.000" (1)	.20"	.50"
60410BK	100	UV BLACK	1.000" (1)	.20"	.50"
60411	100	NATURAL	1.25" (1-1/4)	.20"	.50"
60411BK	100	UV BLACK	1.25" (1-1/4)	.20"	.50"

Steel Cable Clamps

- Vinyl-dipped or EPDM rubber cushion protects cable
- Mounts quickly and easily

CAT. NO.	HOLDING DIAMETER	STUD SIZE	CUSHION	PKG. QTY.
60102-14	1/4"	1/4"	RUBBER	100
60104-14	3/8"	1/4"	RUBBER	100
60106-38	1/2"	3/8"	RUBBER	100
60107-38	5/8"	3/8"	RUBBER	50
60108-38	3/4"	3/8"	RUBBER	50
60110-38	1"	3/8"	RUBBER	25
60112-38	1 1/2"	3/8"	RUBBER	25
60114-38	2"	3/8"	RUBBER	25
60202-14	1/4"	1/4"	VINYL DIPPED	100
60204-14	3/8"	1/4"	VINYL DIPPED	100
60206-38	1/2"	3/8"	VINYL DIPPED	100
60207-38	5/8"	3/8"	VINYL DIPPED	50
60208-38	3/4"	3/8"	VINYL DIPPED	50
60210-38	1"	3/8"	VINYL DIPPED	25
60212-38	1 1/2"	3/8"	VINYL DIPPED	25
60214-38	2"	3/8"	VINYL DIPPED	25



60108-38



60208-38

SPLIT LOOM**Polyethylene Split Loom**

- Thick wall offers superior crush-resistance and a tight seam enclosure
- Temperature rating: -15° F to 195° F (-26° C to 90° C)
- Flexible cable routing and easy break-out
- Rounded edges prevent cutting cable

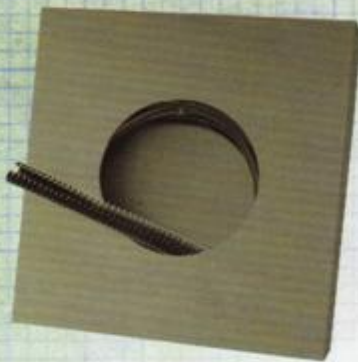

DISPENSER BOX



FASTENED COIL

CAT. NO.	SIZE	LENGTH	PACKAGE
80002-25BOX	1/4"	25'	DISPENSER BOX
80002-25COIL	1/4"	25'	FASTENED COIL
80002-100COIL	1/4"	100'	FASTENED COIL
80002-BRL	1/4"	GAYLORD*	BULK BOX
80004-25BOX	3/8"	25'	DISPENSER BOX
80004-25COIL	3/8"	25'	FASTENED COIL
80004-100COIL	3/8"	100'	FASTENED COIL
80004-BRL	3/8"	GAYLORD8	BULK BOX
80005-25BOX	7/16"	25'	DISPENSER BOX
80005-25COIL	7/16"	25'	FASTENED COIL
80005-100COIL	7/16"	100'	FASTENED COIL
80005-BRL	7/16"	GAYLORD*	BULK BOX
80006-25BOX	1/2"	25'	DISPENSER BOX
80006-25COIL	1/2"	25'	FASTENED COIL
80006-100COIL	1/2"	100'	FASTENED COIL
80006-BRL	1/2"	GAYLORD*	BULK BOX
80007-25BOX	5/8"	25'	DISPENSER BO
80007-25COIL	5/8"	25'	FASTENED COIL
80007-100COIL	5/8"	100'	FASTENED COIL
80007-BRL	5/8"	GAYLORD*	BULK BOX
80008-25BOX	3/4"	25'	DISPENSER BOX
80008-25COIL	3/4"	25'	FASTENED COIL
80008-100COIL	3/4"	100'	FASTENED COIL
80008-BRL	3/4"	GAYLORD*	BULK BOX
80010-25BOX	1"	25'	DISPENSER BOX
80010-25COIL	1"	25'	FASTENED COIL
80011-25COIL	1 1/4"	25'	FASTENED COIL
80012-15COIL	1 1/2"	15'	FASTENED COIL

Consult factory for current Gaylord quantities

SPLIT LOOM ACCESSORIES

Split Loom Tee

- Quick and easy solutions for wire bundling and abrasive resistance

CAT. NO.	SIZE	QTY. PER PKG.
85001	.413" x .413" x .413"	10 PCS
85002	.413" x .350" x .350"	10 PCS
85004	.500" x .350" x .750"	10 PCS
85005	.750" x .350" x .750"	10 PCS
85006	.750" x .500" x .750"	10 PCS
85007	.750" x .750" x .500"	10 PCS
85008	.500" x .500" x .500"	10 PCS



SPLIT LOOM TEE

Loom Outlet Fitting

CAT. NO.	SIZE	QTY. PER PKG.
86004	.413" x .413"	10 PCS
86005	.413" x .500"	10 PCS
86006	.500" x .500"	10 PCS



OUTLET FITTING

Loom Rosebud Clip

CAT. NO.	SIZE	QTY. PER PKG.
87003	.350"	10 PCS
87004	.413"	10 PCS
87006	.500"	10 PCS
87008	.750"	10 PCS



ROSEBUD CLIP

Loom Rosebud Clip Offset

CAT. NO.	SIZE	QTY. PER PKG.
88003	.350"	10 PCS
88006	.413"/.500"	10 PCS

1/4"

Depressed Center Wheels



A24N - Fast Grinding

- Aluminum oxide grain
- Soft bond for fast stock removal

METAL Ferrous Metals (iron, steel, welds, etc.)

STAINLESS Low grade stainless steel

A24R - Long Life

- Aluminum oxide grain
- Our most popular wheel
- For general purpose grinding
- Longer life for fewer wheel changes

METAL Ferrous Metals (iron, steel, welds, etc.)

A24T - Edge Grinding

- Aluminum oxide grain
- Hard bond designed for edge and bevel grinding and other applications where a harder wheel is preferred
- Longer life for fewer wheel changes

METAL Ferrous Metals (iron, steel, welds, etc.)

GT Quick Tip
The "softer" a grinding wheel is (A24N) the faster it will remove metal.

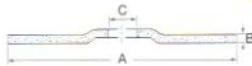

Size			Max RPM	Grades Available			Qty Per Box	Qty Per Ctn	Lbs Per Box
A Dia.	B Width	C Bore		Part Number					
3	3/16	3/8	18,000	20001	-	-	25	100	3
3	1/4	3/8	18,000	20002	20005	-	25	100	4
4	3/16	3/8	13,500	20010	-	-	25	100	5
4	1/4	3/8	13,500	20012	20019	-	25	100	7
4	1/4	5/8	13,500	20015	20013	-	25	100	7
4-1/2	3/16	7/8	13,300	20050	-	-	25	100	8
4-1/2	3/16	5/8-11	13,300	20150	-	-	10	40	6
4-1/2	1/4	7/8	13,300	20060	20063	20065	25	100	8
4-1/2	1/4	5/8-11	13,300	20160	20163	20165	10	40	6
5	1/4	7/8	12,200	20070	20073	20075	25	100	10
5	1/4	5/8-11	12,200	20170	20173	20175	10	40	6
6	1/4	7/8	10,200	20078	20079	20280	25	50	15
6	1/4	5/8-11	10,200	20178	20076	20180	10	40	10
7	1/4	7/8	8,500	20081	20080	20285	25	50	24
7	1/4	5/8-11	8,500	20085	20086	20185	10	40	14
9	1/4	7/8	6,600	20091	20090	20295	25	50	39
9	1/4	5/8-11	6,600	20095	20096	20195	10	40	20



GENERAL PURPOSE



- Virgin aluminum oxide grain assures consistent high stock removal for tough applications
- All sizes are made with uniform grain throughout, no filler grain used in the backing
- All wheels internally reinforced with the highest quality fiberglass for maximum safety
- Super-Lock™ Hub on all 5/8-11 threaded wheels is the safest, vibration-free design



Die Grinder

Thin High Speed Cut-off Wheels

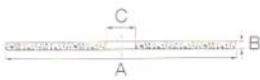

A24R - General Purpose

- Aluminum oxide grain
- General purpose, long life

METAL Ferrous metals (iron, steel, welds, etc.)

A36T - Fast Cutting

- Aluminum oxide grain
- Hard bond for aggressive cutting on rough applications

METAL Ferrous metals (iron, steel, welds, etc.)

STAINLESS Stainless steel

A60S

.045

- Thin .045 width
- Use with reusable 5/8-11 adaptor to fit angle grinders

- Extremely fast cutting with long life

METAL Ferrous and/or non-ferrous metals (iron, steel, welds, etc.)

A60T - Burr Free

- Hard bond for smooth cutting
- For use in nuclear, aerospace, automotive, foundry industries, and plant maintenance

METAL Ferrous metals (iron, steel, welds, etc.)

STAINLESS High tensile metals



Quick Tip

Try .045 sizes for longer life and better value

1/4" Shank adaptors available on page 149

GENERAL PURPOSE

A Dia.	B Width	C Bore	Max RPM	Grades Available Part Numbers				Qty Per Box	Qty Per Ctn	Lbs Per Box
				A24R	A36T	A60S	A60T			
2	1/16	1/4	30,558	-	23004	-	23005	50	50	1
2	1/16	3/8	30,558	-	23002	-	23003	50	50	1
2	.035	1/4	30,558	-	23012	-	23013	100	100	1
2	.035	3/8	30,558	-	23010	-	23011	100	100	1
2-1/2	1/16	1/4	24,446	-	23022	-	23023	50	50	2
2-1/2	1/16	3/8	24,446	-	23020	-	23021	50	50	2
2-1/2	.035	1/4	24,446	-	23032	-	23033	100	100	2
2-1/2	.035	3/8	24,446	-	23030	-	23031	100	100	2
3	1/16	1/4	25,000	-	23042	-	23043	50	50	3
3	1/16	3/8	25,000	-	23040	-	23041	50	50	3
3	.035	1/4	25,000	-	23052	-	23053	100	100	3
3	.035	3/8	25,000	-	23050	-	23051	100	100	3
3	1/8	3/8	20,372	23060	-	-	-	25	100	2
4	1/16	1/4	19,000	-	23067	-	23068	50	50	5
4	1/16	3/8	19,000	-	23065	-	23066	50	50	5
4	1/16	5/8	19,000	-	23061	-	23062	50	50	5
4	.035	1/4	19,000	-	23071	-	23072	100	100	5
4	.035	3/8	19,000	-	23069	-	23070	100	100	5
4	.035	5/8	19,000	-	23063	-	23064	100	100	5
4	.045	5/8	19,000	-	-	23099	-	50	200	4
4	1/8	3/8	15,278	23075	-	-	-	25	100	4
4-1/2	.045	7/8	13,300	-	-	23101	-	50	200	4
5	.045	7/8	12,200	-	-	23103	-	25	25	2
6	1/16	1/2	10,186	-	23202	-	23203	50	50	8
6	1/16	5/8	10,186	-	23200	-	23201	50	50	8
6	.035	1/2	10,186	-	23206	-	23207	50	50	5
6	.035	7/8	10,186	-	23210	-	23211	50	50	5
6	.035	5/8	10,186	-	23204	-	23205	50	50	5
6	.045	5/8	10,200	-	-	23105	-	50	200	4
6	.045	7/8	10,200	-	-	23106	-	50	200	4
7	1/16	1-1/4	8,732	-	23250	-	23251	50	50	12
7	1/16	5/8	8,732	-	23265	-	23266	50	50	6
7	.035	1-1/4	8,732	-	23252	-	23253	50	50	4
7	.045	5/8	8,500	-	-	23107	-	50	200	4
8	1/16	5/8	7,640	-	23275	-	23276	50	50	7
8	1/16	1-1/4	7,640	-	23277	-	23278	50	50	7



- Type 1 shape for square, burr-free cutting
- Externally reinforced with fiberglass layers to provide ultimate safety in a thin wheel
- Wide range of grit sizes available for aggressive action to burr-free cutting

TYPE 1 Chop Saw Wheels

Cutting



Stud King®

- Aluminum oxide grain
- General purpose cool cutting on thin metals
- Burr-free finish

METAL Metal studding, thin rebar, light gauge metals

Iron Worker™

- Aluminum oxide grain
- **Fast cutting**
- Excellent for use on angle iron, channel iron, heavy rebar, and other ferrous metals

METAL Structural metal applications

Saitech Steel Worker®

New & Improved Formula for 14"

- Formulated with 3M Cubitron grain
- Extremely fast, burr-free cutting

STAINLESS Stainless steel, high tensile alloys

METAL Ferrous metals (steel, iron, welds, etc.)

Non-Ferrous Metals (Aluminum)

- Aluminum oxide grain
- Special **non-loading** formulation

METAL Non-ferrous metals (aluminum, bronze, brass, etc.)

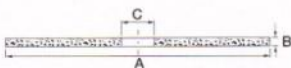

Size			Max RPM	Grades Available				Qty Per Box	Qty Per Ctn	Lbs Per Box
A Dia.	B Width	C Bore		Part Numbers						
				S.K.	I.W.	Saitech™	Alum.			
10	3/32	5/8	6,100	24035	-	-	-	25	50	20
12	3/32	1	5,100	24030	24031	-	-	10	50	11
12	3/32	1	5,100	-	-	24033	-	10	50	11
14	3/32	1	4,400	24050	24051	-	-	10	20	16
14	3/32	1	4,400	-	-	24053	-	10	20	16
14	3/32	1	4,400	-	-	-	24052	10	20	16
16	3/32	1	3,700	24010	24011	-	-	10	20	23
16	3/32	1	3,700	-	-	24013	-	10	20	23



- Specially formulated for use on low horsepower chop saw machines for fast cutting with minimal pressure
- Four specialty formulas give you the exact wheel for your cutting application
- Externally reinforced with the highest quality fiberglass to withstand the toughest applications

SPECIALTY

BENCH WHEELS

Grinding



Bench Grinder

A

- Aluminum oxide grain
- General purpose
- For sharpening tools and light stock removal

METAL Ferrous metals
(carbon steel, steel, iron, forgings, etc.)

GC

- Green silicon carbide grain
- Extremely sharp grain for faster, burr-free cutting
- Use on carbide tipped tools, cast iron

METAL Ferrous and/or non-ferrous metals



Reduction bushings enclosed with each wheel

6", 7"	3/4, 5/8, 1/2
8"	3/4, 5/8
10"	1, 3/4
12", 14"	1-1/4, 1

Aluminum Oxide

Size			Max RPM	Grades Available					Lbs Per Box
A Dia.	B Width	C Bore		Part Numbers					
6	1/2	1	4,138	-	28003	-	28004	28005	1-1/2
6	3/4	1	4,138	-	28000	-	28001	28002	2
6	1	1	4,138	-	28006	-	28007	28008	2-1/2
7	3/4	1	3,600	-	28010	-	28011	28012	2-1/2
7	1	1	3,600	-	28013	-	28014	28015	3-1/2
8	3/4	1	3,600	-	28020	-	28021	28022	3-1/2
8	1	1	3,600	-	28023	-	28024	28025	4-1/2
10	1	1-1/4	2,483	-	28040	28043	28041	28042	7
10	1-1/2	1-1/4	2,483	-	28050	28053	28051	28052	10
12	2	1-1/2	2,069	28060	28063	28061	28062	-	19-1/2
14	2	1-1/2	1,773	28070	28073	28071	28072	-	28

Green Silicon Carbide

Size			Max RPM	Grades Available			Lbs Per Box
A Dia.	B Width	C Bore		Part Numbers			
6	3/4	1	4,138	28100	28101	28102	1-1/2
6	1	1	4,138	28103	28104	28105	2
7	1	1	3,600	28113	28114	28115	2-1/2
8	1	1	3,600	28123	28124	28125	3-1/2
10	1	1-1/4	2,483	28140	28141	28142	6-1/2
10	1-1/2	1-1/4	2,483	28150	28151	28152	10
12	2	1-1/2	2,069	28160	28161	28162	19-1/2
14	2	1-1/2	1,773	28170	28171	28172	28



- Vitrified bond for long life
- Available in two formulations for a wide range of applications
- Individually packaged for safety and convenience

VITRIFIED

Aluminum Oxide

LAMINATED DISCS



Portable Grinder



SAIT-LOK™

All-metal attachment on disc ensures a secure fit to the backing pad (see page 89 for photo)

SAIT-LOK-R™

Nylon screw threaded hub for easy mounting to the backing pad

See page 151 for backing pads

2A

- Aluminum oxide grain
- **General purpose, long life**
- Easy disc changes by twisting to unlock backing pad

- METAL** Ferrous and/or non-ferrous metals
- WOOD** Wood, plastic, fiberglass, etc.

3A

- Premium aluminum oxide grain
- Cooling agents for cool cutting and long life
- **Fast stock removal**
- Easy disc changes by twisting to unlock backing pad

- STAINLESS** Stainless steel, high tensile steel, titanium
- METAL** Ferrous and/or non-ferrous metals

Size	Grit	SAIT-LOK™ Part No.		SAIT-LOK-R™ Part No.		Qty Per Box
		2A	3A	2A	3A	
1"	36	52208	50208	-	-	100
	40	52209	50209	-	-	100
	50	52210	50210	-	-	100
	60	52211	50211	-	-	100
	80	52212	50212	-	-	100
	100	52213	50213	-	-	100
1-1/2"	120	52214	50214	-	-	100
	36	52215	50215	52264	50264	100
	40	52216	50216	52265	50265	100
	50	52217	50217	52266	50266	100
	60	52218	50218	52267	50267	100
	80	52219	50219	52268	50268	100
2"	100	52220	50220	52269	50269	100
	120	52221	50221	52270	50270	100
	36	52222	50222	52271	50271	100
	40	52223	50223	52272	50272	100
	50	52224	50224	52273	50273	100
	60	52225	50225	52274	50274	100
3"	80	52226	50226	52275	50275	100
	100	52227	50227	52276	50276	100
	120	52228	50228	52277	50277	100
	36	52229	50229	52278	50278	50
	40	52230	50230	52279	50279	50
	50	52231	50231	52280	50280	50
3"	60	52232	50232	52281	50281	50
	80	52233	50233	52282	50282	50
	100	52234	50234	52283	50283	50
	120	52235	50235	52284	50284	50

LAMINATED DISCS



- 2-ply construction is rugged enough for contoured surfaces or flat surfaces
- Quick-change backings make for fast easy disc changes and less downtime
- Universal backings fit most major backing pad brands on the market

High Performance

FLAP DISCS



Angle Grinder

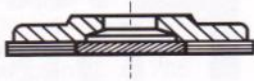

Saitlam (flat shape)

- Available in 2A aluminum oxide, 3A aluminum oxide, and Z zirconium
- **Nylon 6/6 backing** - a non-scratching, high strength backing resistant to temperature extremes, common chemicals, and solvents
- Provides an even "finish ready" surface
- Excellent for miter joints, corners, and edges



Saitlam K (conical shape)

- Available in 2A aluminum oxide and Z zirconium
- Nylon 6/6 backing - a non-scratching, high strength backing resistant to temperature extremes, common chemicals, and solvents
- **Conical shape ideal when working with large surfaces or complex work shapes**
- Working angle is "built in"

PROPER MOUNTING

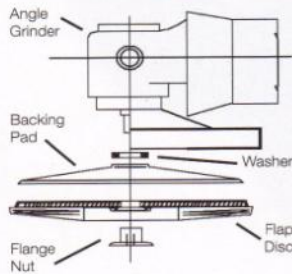

Saitlam

Mat'l	Size		Grit	Part No.
	Dia.	Arbor		
2A	4	5/8	40	73240
	4	5/8	60	73260
	4	5/8	80	73280
	4	5/8	120	73220
	4-1/2	7/8	40	73440
	4-1/2	7/8	60	73460
	4-1/2	7/8	80	73480
	4-1/2	7/8	120	73420
	6-1/2	7/8	36	73636
	6-1/2	7/8	50	73650
3A	4	5/8	40	73040
	4	5/8	60	73060
	4	5/8	80	73080
	4	5/8	120	73020
	4-1/2	7/8	40	73340
	4-1/2	7/8	60	73360
	4-1/2	7/8	80	73380
	4-1/2	7/8	120	73320
	6-1/2	7/8	36	73836
	6-1/2	7/8	50	73850
Z	4	5/8	40	73140
	4	5/8	50	73150
	4	5/8	60	73160
	4	5/8	80	73180
	4-1/2	7/8	40	73540
	4-1/2	7/8	50	73550
	4-1/2	7/8	60	73560
	4-1/2	7/8	80	73580
	6-1/2	7/8	36	73736
	6-1/2	7/8	50	73750
6-1/2	7/8	60	73760	
6-1/2	7/8	80	73780	

Packaging

- 4" 10/box with nut
- 4-1/2" 10/box with nut
- 6-1/2" 10/box with backing pad and nut

RPM's for Saitlam / Saitlam K

- 4" 13,000
- 4-1/2" 11,000
- 6-1/2" 8,600

NOTE: 4" and 4-1/2" Saitlam and Saitlam K must be used with nut
6-1/2" must be used with backing pad and nut

See page 152 for additional pads and nuts

Saitlam K

Mat'l	Size		Grit	Part No.
	Dia.	Arbor		
2A	4-1/2	7/8	40	73490
	4-1/2	7/8	60	73491
	4-1/2	7/8	80	73492
Z	4-1/2	7/8	120	73493
	4-1/2	7/8	40	73590
	4-1/2	7/8	50	73591
	4-1/2	7/8	60	73592
	4-1/2	7/8	80	73593

FLAP DISCS

FLAP DISCS

High Performance



Saitlam F (conical shape, fiberglass backing)

- Available in 2A, 3A aluminum oxide and Z zirconium
- Fiberglass backing for lighter, more silent operation
- Fiberglass backing will not splinter or smear on the workpiece
- Backing wears with the abrasive cloth
- Go from stock removal to finishing with one disc



Mat'l	Size		Grit	Part No. Saitlam F
	Dia.	Arbor		
2A	4-1/2	7/8	40	75440
	4-1/2	7/8	50	75450
	4-1/2	7/8	60	75460
	4-1/2	7/8	80	75480
	4-1/2	7/8	120	75420
	4-1/2	5/8-11	40	76440
	4-1/2	5/8-11	50	76450
	4-1/2	5/8-11	60	76460
	4-1/2	5/8-11	80	76480
	4-1/2	5/8-11	120	76420
	5	7/8	40	75540
	5	7/8	50	75550
	5	7/8	60	75560
	5	7/8	80	75580
	5	7/8	120	75520
	5	5/8-11	40	76540
	5	5/8-11	50	76550
	5	5/8-11	60	76560
	5	5/8-11	80	76580
	5	5/8-11	120	76520
7	7/8	40	75740	
7	7/8	50	75750	
7	7/8	60	75760	
7	7/8	80	75780	
7	7/8	120	75720	
7	5/8-11	40	76740	
7	5/8-11	50	76750	
7	5/8-11	60	76760	
7	5/8-11	80	76780	
7	5/8-11	120	76720	
3A	4-1/2	7/8	40	73341
	4-1/2	7/8	60	73361
	4-1/2	7/8	80	73381
	4-1/2	7/8	120	73321
	4-1/2	5/8-11	40	74341
	4-1/2	5/8-11	60	74361
	4-1/2	5/8-11	80	74381
	4-1/2	5/8-11	120	74321
	5	7/8	40	73804
	5	7/8	60	73806
	5	7/8	80	73808
	5	7/8	120	73802
	5	5/8-11	40	74804
	5	5/8-11	60	74806
	5	5/8-11	80	74808
	5	5/8-11	120	74802
	7	7/8	40	73704
	7	7/8	50	73705
	7	7/8	60	73706
	7	7/8	80	73708
7	7/8	120	73702	
7	5/8-11	40	74704	
7	5/8-11	50	74705	
7	5/8-11	60	74706	
7	5/8-11	80	74708	
7	5/8-11	120	74702	

RPM's

4-1/2"	13,300
5"	12,200
7"	8,500

Packaging

4-1/2" x 7/8	10/box
4-1/2" x 5/8-11	10/box
5" x 7/8	10/box
5" x 5/8-11	10/box
7" x 7/8	10/box
7" x 5/8-11	10/box

Mat'l	Size		Grit	Part No. Saitlam F
	Dia.	Arbor		
Z	4-1/2	7/8	40	73940
	4-1/2	7/8	50	73950
	4-1/2	7/8	60	73960
	4-1/2	7/8	80	73980
	4-1/2	7/8	120	73920
	4-1/2	5/8-11	40	74940
	4-1/2	5/8-11	50	74950
	4-1/2	5/8-11	60	74960
	4-1/2	5/8-11	80	74980
	4-1/2	5/8-11	120	74920
	5	7/8	40	73941
	5	7/8	50	73951
	5	7/8	60	73961
	5	7/8	80	73981
	5	7/8	120	73921
	5	5/8-11	40	74941
	5	5/8-11	50	74951
	5	5/8-11	60	74961
	5	5/8-11	80	74981
	5	5/8-11	120	74921
7	7/8	40	73942	
7	7/8	50	73952	
7	7/8	60	73962	
7	7/8	80	73982	
7	7/8	120	73922	
7	5/8-11	40	74942	
7	5/8-11	50	74952	
7	5/8-11	60	74962	
7	5/8-11	80	74982	
7	5/8-11	120	74922	

FLAP DISCS

General Purpose - Zirconium

FLAP DISCS



Fiberglass Backing

- Allows for lighter, quieter operation
- Will not splinter or smear on the workpiece
- Backing wears with the abrasives cloth



Saitlam UK (conical shape)

- Conical shape ideal for working with large surfaces or complex shapes
- Working angle is "built-in"
- For general purpose stock removal and finishing



Saitlam UP (flat shape)

- Flat shape ideal for use on miter joints, corners and edges
- Provides an even "finish ready" surface
- For general purpose stock removal and finishing



Plastic Backing

- A non-scratching, high strength backing resistant to temperature extremes, common chemicals and solvents



Saitlam KN (conical shape)

- Conical shape ideal for working with large surfaces or complex shapes
- Working angle is "built-in"
- For general purpose stock removal and finishing



Saitlam PN (flat shape)

- Flat shape ideal for use on miter joints, corners and edges
- Provides an even "finish ready" surface
- For general purpose stock removal and finishing

FLAP DISCS

Mat'l	Size			Part Nos.			
	Dia.	Arbor	Grit	Saitlam UK	Saitlam UP	Saitlam PN	Saitlam KN
Z	4-1/2	7/8	40	73685	73890	73502	-
	4-1/2	7/8	50	73686	73891	73503	-
	4-1/2	7/8	60	73687	73892	73504	-
	4-1/2	7/8	80	73688	73893	73505	-
	4-1/2	7/8	120	73689	73894	73506	-
	5	7/8	40	73694	73895	-	74212
	5	7/8	50	73695	73896	-	74213
	5	7/8	60	73696	73897	-	74214
	5	7/8	80	73697	73898	-	74215
	5	7/8	120	73698	73899	-	74216
	7	7/8	40	73714	-	-	-
	7	7/8	50	73715	-	-	-
	7	7/8	60	73716	-	-	-
	7	7/8	80	73717	-	-	-
7	7/8	120	73718	-	-	-	

Packaging

- 4-1/2" 10/box
- 5" 10/box
- 7" 10/box

SHOP ROLLS

Handy & Industrial



Industrial Rolls - EA-F

- Aluminum oxide grain
- Premium quality EA-F material for very high flexibility
- High tensile strength, extra durable backing
- Long life
- **Primarily for machine applications**

METAL Ferrous and/or non-ferrous metals (iron, aluminum, copper, normal and high tensile steel)

WOOD Wood, fiberglass, etc.

Handy Rolls - DA-F

- Aluminum oxide grain
- High quality DA-F material for high flexibility
- Medium tensile strength
- **Primarily for hand applications**

METAL Ferrous and/or non-ferrous materials (iron, aluminum, copper, normal and high tensile steel)

WOOD Wood, fiberglass, etc.



EA-F Industrial Rolls

Size Width	Grit	Part No.
1"	40	80415
	50	80515
	60	80615
	80	80815
	100	81015
	120	81215
	150	81515
	180	81815
	220	82215
	240	82415
1-1/2"	320	83215
	400	83415
	40	80416
	50	80516
	60	80616
	80	80816
	100	81016
	120	81216
	150	81516
	180	81816
2"	220	82216
	240	82416
	320	83216
	400	83416
	40	80430
	50	80530
	60	80630
	80	80830
	100	81030
	120	81230
2"	150	81530
	180	81830
	220	82230
	240	82430
	320	83230
	400	83430

DA-F Handy Rolls

Size Width	Grit	Part No.
1"	40	80405
	50	80505
	60	80605
	80	80805
	100	81005
	120	81205
	150	81505
	180	81805
	220	82205
	240	82405
1-1/2"	320	83205
	400	83405
	40	80406
	50	80506
	60	80606
	80	80806
	100	81006
	120	81206
	150	81506
	180	81806
2"	220	82206
	240	82406
	320	83206
	400	83406
	40	80420
	50	80520
	60	80620
	80	80820
	100	81020
	120	81220
2"	150	81520
	180	81820
	220	82220
	240	82420
	320	83220
	400	83420

Packaging
50 yd length, 1/box

Tech INFO

- Resin over resin construction for a strong bond resistant to heat and moisture
- Egyptian cotton cloth backing for superior durability
- Available in 2 tensile strengths for a wide range of applications
- Open coat structure prevents loading
- Box label UPC bar coded for easy identification and inventory maintenance

SHOP ROLLS

NON-WOVEN

Hand Pads



Hand Sander

Brown

- Heavy duty
- Excellent for removing heavy rust and cleaning welds

METAL Ferrous and/or non-ferrous metals

Maroon

- General purpose
- For removing light rust
- Excellent for cleaning and brightening

METAL Ferrous and/or non-ferrous metals

Black

- For blending and finishing
- Excellent for paint removal

STAINLESS Stainless steel

METAL Ferrous and/or non-ferrous metals

Green

- General cleaning
- Excellent for stripping paint and varnish

METAL Ferrous and/or non-ferrous metals

WOOD Paint, varnish

Gray

- Ultra fine
- For light finishing
- Excellent for sanding before/between finish coats

METAL Non-ferrous metals

WOOD Wood

White

- Light duty
- For light cleaning and polishing

WOOD Fiberglass, vinyl, plastic, formica

CONCRETE Ceramic



Size	Grade	Color	Part Nos.	Pads Per Box
6 x 9	Heavy Duty	Brown	77440	20
	General Purpose	Maroon	77447	20
	Stainless	Black	77446	20
	Stripper	Green	77496	20
	Ultra Fine	Gray	77448	20
	Light Duty	White	77486	20

Handle available for uniform finishing on page 151



- Non-woven synthetic fiber impregnated with abrasive grain for surface conditioning without damage to or removal of base material. Resists loading and heat build-up
- Wet/dry construction for use in a wide range of applications
- Available in a variety of grades from heavy duty to polishing applications
- Reusable and long lasting design for economical use
- Box label UPC bar coded for easy identification and inventory maintenance

NON-WOVEN

NON-WOVEN

Discs



Brown

- Heavy duty
- Excellent for deburring, blending, cleaning, polishing

STAINLESS Stainless steel

METAL Ferrous and/or non-ferrous materials

WOOD Fiberglass, gaskets

Maroon

- General purpose
- Excellent for deburring, blending, cleaning, polishing

STAINLESS Stainless steel

METAL Ferrous and/or non-ferrous materials

WOOD Fiberglass, gaskets

Blue

- Very fine
- Excellent for cleaning and finishing

STAINLESS Stainless steel

METAL Ferrous and/or non-ferrous materials

WOOD Fiberglass, gaskets



SAIT-LOK™

All-metal attachment on disc and backing pad ensures a safe fit

SAIT-LOK-R™

Nylon screw type threaded hub for easy mounting to backing pad



See page 151 for backing pads

Hook & Loop style discs in 4" - 8" available on page 126

Size	Grade	Color	SAIT-LOK™ Part No.	SAIT-LOK-R™ Part No.	Qty Per Box
1-1/2"	Coarse	Brown	77200	77300	50
	Medium	Maroon	77202	77302	50
	Very Fine	Blue	77203	77303	50
2"	Coarse	Brown	77206	77306	50
	Medium	Maroon	77208	77308	50
	Very Fine	Blue	77209	77309	50
3"	Coarse	Brown	77212	77312	25
	Medium	Maroon	77214	77314	25
	Very Fine	Blue	77215	77315	25

Tech INFO

- Non-woven synthetic fiber coated with aluminum oxide grain resists loading for long life
- Flexible construction for use on contoured surfaces
- Non-woven disc can be switched to laminated disc using same backing pads for less downtime
- Box label UPC bar coded for easy identification and inventory maintenance

NON-WOVEN

Bench/Large Cup



Bench Grinder



Angle Grinder

BRUSHES

Bench Wire Wheels

- Dense, compact crimped steel wire brush face
- **May be stacked to achieve wider work face**
- Primary application: For general scale removal, cleaning and surface preparation
- Standard 2" arbor, with adaptor to listed arbor
- Includes bushing pairs to adapt to variety of arbors

Additional arbors available

Part No.	Size
95201	2 x 1/2
95203	2 x 5/8
95204	2 x 3/4
95206	2 x 1
95207	2 x 1-1/4

** not available for part number 09558 and 09555



Size			Face Width	Trim Length	Max RPM	INDUSTRIAL		BLUE LINE™
Dia.	Wire	Arbor				Part No.	Std Pkg	Part No.
6	.014	5/8, 1/2	Wide	1-1/16"	6,000	09557	1	06557
6	.014	5/8, 1/2	Narrow	1-3/16"	6,000	09558**	1	06558
6	.008	5/8, 1/2	Narrow	1-1/16"	6,000	09555**	1	06555
7	.014	5/8	Wide	1-9/16"	6,000	09559	1	06559
8	.014	5/8	Wide	1-1/2"	4,000	01411	1	06556
10	.014	3/4	Wide	2"	3,600	09560	1	-

Packaging

Standard industrial packaging or Blue Line™ point of sale display packaging

Large Cup Brushes

- Available in the following wire types:
 - Knot wire for low to medium flexibility and aggressive cutting action
 - Crimped wire which has higher flexibility for light cleaning and removal, especially on irregular surfaces
- Primary application: **For fast cleaning of large surfaces**

Knot Wire

Size			Rows	Trim Length	Max RPM	INDUSTRIAL		BLUE LINE™
Dia.	Wire	Arbor				Part No.	Std Pkg	Part No.
4	.020	5/8-11	1	1-3/8"	9,000	03407	1	06407
4	.020	5/8-11	1	Stainless*	9,000	03406	1	06406
6	.020	5/8-11	1	1-3/4"	6,600	03409	1	06409
6	.035	5/8-11	1	1-3/4"	6,600	03410	1	06410
6	.020	5/8-11	2	1-3/4"	6,000	03411	1	06411
6	.035	5/8-11	2	1-3/4"	6,000	03412	1	06412
6	.020	5/8-11	1	Stainless*	6,000	03413	1	06413

Crimped Wire

4	.020	5/8-11	-	1-1/8"	9,000	09551	1	06551
5	.020	5/8-11	-	1-1/2"	8,000	09552	1	-
5	.020	5/8-11	Stainless*	1-1/2"	8,000	09554	1	06554
6	.020	5/8-11	-	1-1/2"	6,600	09553	1	06553



Packaging

Standard industrial packaging or Blue Line™ point of sale display packaging

* 302 stainless steel wire used

BRUSHES**Scratch/Miscellaneous**

Hand Brush

Hand Brush

**Scratch Brushes**

- Excellent for light scale removal
- Available in the following wire types:
 - Carbon steel wire for general purpose cleaning
 - Stainless steel wire is carbon free
 - Brass wire for general purpose cleaning
- Primary application: Maintenance cleaning

*302 stainless steel wire used

Size Rows	Wire Size	Type	Part No.	Std Pkg
3 x 19	.014	Curved Handle	05751	12
3 x 19	.014	Curved Handle w/Scraper	05760	12
3 x 19	.012	Curved-Stainless*	05755	12
3 x 14	.014	V-Groove Scratch	05764	12
3 x 14	.012	V-Groove Scratch-Stainless*	05765	12
4 x 16	.014	Shoe Handle	05753	12
4 x 16	.014	Shoe Handle w/Scraper	05761	12
4 x 16	.012	Shoe Handle-Stainless*	05763	12
4 x 19	.014	Curved Handle	05752	12
3 x 7	.006	Small Cleaning Brush-Stainless*	05759	12
3 x 7	.006	Small Cleaning Brush w/Plastic Handle-Stainless*	05766	12
3 x 7	.006	Small Cleaning Brush-Brass	05762	12
3 x 7	.006	Small Cleaning Brush w/Plastic Handle-Brass	05768	12
3 x 15	-	Chipping Hammer Brush	05757	12

Miscellaneous Brushes**Metal Chip Brush**

- Durable, long lasting
- For cleaning metal chips from work surfaces

Acid Brushes

- Quality horsehair bristles
- Machine trimmed and crimped to specification

Paint Brushes

- Quality horsehair bristles
- Wood handle



Brush Type	Width	Trim Length	Overall Length	Part No.	Std Pkg
Metal Chip	1-1/2"	1-1/2"	5-5/16"	00510	12 pcs
	3/8"	3/4"	6"	00501	1 gross
Acid Brush	7/16"	3/16"	6-1/2"	00502	1 gross
	9/16"	7/8"	6-1/8"	00503	1 gross
	1/2"	1-1/2"	7"	00511	72 pcs
Paint Brush	1"	1-1/2"	7-1/2"	00512	72 pcs
	1-1/2"	1-1/2"	7-1/2"	00513	72 pcs
	2"	1-1/2"	7-1/2"	00514	72 pcs
	3"	1-1/2"	8"	00515	48 pcs
	4"	2-1/4"	9-1/2"	00516	12 pcs

BRUSHES

AEF Absorbents

100% fibre-locked/needlepunched polypropylene sorbents in pads, pillows, booms, rolls, sweeps, and caterpillars for the most efficient, convenient and economical removal of oil and chemical spills from land or water.

- **MOST REUSABLE** — the only truly reusable sorbents . . . wringable, spinnable and washable hundreds of times. Greatest waste-stream minimizers . . . most recyclable.
- **STRONGEST** — non-tearing and non-shredding. **Fibre-lock/needlepunch** construction guarantees greatest durability for toughest jobs. **Sewn seams** on pillows and booms allow for rugged and repeated use.
- **MOST ABSORBENT** — pick up significantly more oil than melt-blown sorbents. The only sorbents that absorb no. 6 (Bunker C) oil. Absorb up to 25 times their own weight.
- **FASTEST WORKING** — highest rate of absorption for quickest spill pickup.
- **MOST ECONOMICAL** — save money on expensive waste removal costs by reusing tough, durable **AEF ABSORBENTS** . . . your best choice in spill control.



AEF Absorbents Are Available In Many Convenient Forms



PADS

For marine or land based spills. Excellent for industrial plants, loading docks, machine and maintenance shops, fire departments, municipal spill response or anywhere liquid, chemical or oil spills occur. Also available in "LF" series for light fuel spills—deisel, gasoline, kerosene, jet fuel.

STYLE	SIZE	PACKAGING
A-200 - Standard Pack	18" x 18"	100 pads
A-200 - Double Pack	18" x 18"	200 pads
A-100 - Standard Pack	18" x 18" double wgt.	50 pads
A-100 - Double Pack	18" x 18" double wgt.	100 pads
A-5036	36" x 36" double wgt.	50 pads
A-200LF (light fuel)	18" x 18"	200 pads
A-100LF (light fuel)	18" x 18"	100 pads



ROLLS

Primarily for in-plant use or wherever oil or spills can be tracked by employees. Rolls can be easily cut for custom "pads" in and around machinery. Keeps work area clean. In hydrophobic form, can be used as a "sweep" to absorb oil from water. Also available in "G" series **industrial carpet** (grey heat-set) for heavy duty in-plant use and with vinyl backing to prevent leaking.

STYLE	SIZE	PACKAGING
A-36150R	36" x 150'	1 roll
A-36300R	36" x 300'	1 roll
A-72150R	72" x 150'	1 roll
A-72300R	72" x 300'	1 roll
A-36150H	36" x 150' double wgt.	1 roll
A-36300H	36" x 300' double wgt.	1 roll
A-72150H	72" x 150' double wgt.	1 roll
A-72300H	72" x 300' double wgt.	1 roll
A-36150R-VB	36" x 150' vinyl backed	1 roll
A-36150H-VB	36" x 150' dbl. wgt.-vinyl backed	1 roll
A-36150RLF (light fuel)	36" x 150'	1 roll
A-36150HLF (light fuel)	36" x 150' double wgt.	1 roll
A-36150G (grey) <i>all purpose only</i>	36" x 150' industrial carpet	1 roll



MINI BOOMS

Primarily for industrial, on-land use in plants, terminals, airports. 5' x 10' and 5' x 6' booms are designed especially for around machinery, or wherever leaks occur. **NEW:** Reeled **flat boom** for excellent laydown around machinery. **Sewn seams** for extra strength.

STYLE	SIZE	PACKAGING
A-4MB	5' x 10'	4 booms
A-4MB6	5' x 6'	4 booms
A-FB	4½" x 50'	1 reeled boom



BOOMS

Primarily for marine use. 8" x 10' boom has **grommets** and **fastener** for linking booms to create a containment barrier. Good for spills or discharge in streams, lagoons, settlement ponds, harbors, rivers, or for shoreline protection. **Sewn seams** for extra strength.

STYLE	SIZE	PACKAGING
A-4B	8" x 10'	4 booms



SWEEPS

For oil-on-water spills. Tough polypropylene cord can be anchored to shore, boat or in-place containment boom. "Sweeps" oil from water efficiently.

STYLE	SIZE	PACKAGING
A-S	18" x 100' w/polypropylene cord	1 sweep



PILLOWS

For spills or leaks requiring more absorption than pads. Especially good for water catch basins, sumps, or in combination with booms. **Sewn seams** for extra strength.

STYLE	SIZE	PACKAGING
A-10	18" x 20"	10 pillows

AEF SPECIALTIES

BILGE BOOMS

8" x 15" with cord for absorbing oil in boat bilges. Sewn seams for extra strength.

STYLE	SIZE	PACKAGING
A-BB	8" x 15" bilge boom w/cord	4 booms

CATERpillARS

3 and 6 foot absorbent "mops" for hard to reach areas. Especially good for **no. 6 oil spill** pickup. Can also be used as sweeps in water or holding tanks.

STYLE	SIZE	PACKAGING
A-CAT3	3' caterpillar	2 caterpillars
A-CAT6	6' caterpillar	2 caterpillars

SPILL KITS

Available in many combinations. Can be **custom** designed for special needs.

STYLE	SIZE	PACKAGING
A-SK	many options	1 spill kit

BARREL COVERS

22" diameter double-weight covers for absorbing oil and chemicals from on top of 55 gallon **drums**. Clean and durable.

STYLE	SIZE	PACKAGING
A-BC	22" dia. barrel covers-dble. wgt.	25 covers

Available in **All-purpose** (for liquids, oils, and aqueous based chemicals) or **Hydrophobic** (non-aqueous; absorb oil, not water).
PLEASE SPECIFY YOUR PREFERENCE. NOTE: Used AEF Absorbents must be disposed according to applicable Federal, State, and Local laws.

CLEANER- POLISHES



Lite Finish™ Polishing Cleaner

Removes swirl marks and produces amazing brilliance when used alone or in conjunction with Tru-Grit, Perflex or Rapid Cut compounds. Lite Finish produces deep, lustrous, long-lasting gloss without waxes or fillers.

32 fl. oz. 110132
1 gal. 110101

Restore-It™ Cleaner / Glaze

Removes swirls, micro-scratches and light oxidation. It produces outstanding gloss on all surfaces, especially dark colors. Restore-It contains no scratch-filling waxes, resins or silicones for an honest, long-lasting gloss. Use as a machine glaze with a wool finishing or soft foam pad.

32 fl. oz. 116632
1 gal. 116601

Swirl Remover

Designed to remove swirls from both fresh and cured paint surfaces. Because it contains no fillers, waxes or silicones, Swirl Remover produces a clean, high-gloss finish that doesn't wash away. Use with a wool finishing pad on cured paint finishes; use with a foam pad on fresh paint finishes.

32 fl. oz. 190232
1 gal. 190201

Glaze II Cleaner—Polish

Contains mild cleaners and color brighteners to produce a deep, lustrous shine with excellent water beading and detergent-resistant characteristics. Formulated for machine or hand use.

1 gal. 110601

MAG™ 2 Polish & Glaze

Removes light scratch defects. MAG 2 is designed to be used after MAG 1 Compound. However, on paints with only minor surface damage, MAG 2 can be the starting product in the paint restoration process. Use MAG 2 with foam or blended wool polishing pads.

1 gal. 119901

Headlight Lens Repair Polish

Restores headlights to a like-new condition in under 5-minutes. Safely removes discoloration, light-to-medium scratches and dirt & grime. Also great for plastic, plexiglass, acrylic and boat windshields

16 fl. oz. 128216

NON-VOC WAXES &



Imperial Paste Wax

Provides long-lasting protection with a durable shine. This premium, #1 Carnauba paste wax contains special anti-swirl agents that make it ideal for dark finishes.

32 fl. oz. 114014

Flash™ Liquid Paste Wax

Flash is a liquefied paste wax manufactured with premium, natural carnauba wax and DuPont Zonyl®. This easy-to-use product is easily applied, dries quickly and comes off easily, resulting in a deep, long-lasting gloss. When you need a great finish in a hurry, get it done fast with Flash!

32 fl. oz. 114432
64 fl. oz. 114464
1 gal. 114401

VOC WAXES & SEALANTS



VOC Compliant Imperial Paste Wax

This premium, carnauba paste wax utilizes the same anti-swirl agents and provides the same long lasting protection and shine as our regular Imperial Paste Wax, but in a VOC compliant formula. Features a fresh watermelon scent.

14 oz. 125214

Polyshine™ Polymer Wax

Creates a durable and beautiful high-gloss finish on all types of automotive paints. This premium blend of natural and synthetic waxes and resins is formulated to provide users easy application, fast removal and outstanding paint protection.

1 gal. 121901

Enhancer® Premium Cream Wax

Easy-to-use product applies and dries quickly, leaving a fast-wiping haze. Its unique blend of the finest carnauba wax and other premium ingredients delivers a long-lasting shine that resists repeated washings.

32 fl. oz. 120232
1 gal. 120201

VOC Compliant Cherry Flash

This liquefied paste wax utilizes the same premium carnauba wax and DuPont Zonyl® and provides the same deep, long-lasting gloss as our regular Flash™, but in a VOC compliant formula. Features a fresh cherry scent.

32 fl. Oz. 124832
64 fl. Oz. 124864
1 gal. 124801

Cherry Flash Aerosol

Make hand waxing even faster and easier with this aerosol version of our popular VOC Compliant Cherry Flash.

14 oz. 124820

ONE-STEP PRODUCTS



Nano Care™ Polishing Crème

Usint Nano technology, this one-step polish, specially formulated for dark colored vehicles, creates deep gloss and a glass-like finish. Nano Care Polishing Crème features easy-on/easy-off application and works great when used by hand or by machine. Bring great gloss back to aged, oxidized or environmentally damaged vehicle surfaces quickly and easily. Polishing Crème meets all 2005 California and Ozone Transportation Commission (OTC) VOC standards.

32 fl. oz. 128332
1 gal. 128301

Rejuvenator™ One-Step Paint Restoration

Specially formulated product contains premium carnauba wax for long-lasting protection and rich, deep gloss. Rejuvenator's fast acting formula and one-step convenience speed vehicle paint restoration. Use with wool or foam pads.

32 fl. oz. 111732
1 gal. 111701

WASH & WAXES



Ultimate Foaming Orange™ Wash & Wax

Thick, rich suds, lemon scent and high gloss shine combine to create an out-of-this-world car washing experience. The powerful, high-foam formula removes road film, dirt and grime, leaving a vehicle surface protected from harmful pollutants with a clean, glossy finish. Dilute 1:46.

1 gal. 124001
5 gal. 124005

Ultra Violet™ Premium Wash 'N Wax

Provides durable high-gloss shine in one easy step. Advanced cleaning agents and waxes work together to remove the toughest soils and leave a rich, lustrous shine. Great grape scent. Dilute 1:20.

64 fl. Oz. 107164
1 gal. 107101
5 gal. 107105
30 gal. 107130

HAND GLAZE



Plum Crazy™ Hand Glaze

Removes minor scratches and swirl marks. Plum Crazy produces an easy-on/easy-off high gloss shine on both old and newly painted surfaces. Use this grape-scented, purple crème on all acrylic enamels, acrylic lacquers, urethanes and basecoat/clearcoat finishes.

32 fl. oz. 114732
1 gal. 114701

SPRAY WAXES



Showroom Shine™ Spray Wax

Quickly removes dust, smudges and fingerprints from auto finishes and leaves a bright, glossy, protective shine. Showroom Shine can be used to clean and shine all glass, metal and exterior painted surfaces.

22 fl. oz. 110422
1 gal. 110401
5 gal. 110405

CAR WASH



CW-37™ Premium Car & Truck Wash Concentrate

This environmentally friendly formula produces large quantities of hard working suds. Dilutable up to 1:400.

1 gal. 105701
5 gal. 105705
55 gal. 105755

Liquid Car Wash Concentrate

This biodegradable and phosphate-free concentrate produces thick, rich suds that lift away dirt and oily road film. Dilutable up to 1:128.

1 gal. 102001
5 gal. 102005
55 gal. 102055

Mist-It™ Spray 'N Shine

Easy-to-use surface enhancer. Mist-It is designed to create rich, wet-looking gloss. It is ideal for pre-delivery cleanups and as a lubricant when using overspray clays.

18 fl. oz. 121820
1 gal. 121801
5 gal. 121805

DEODORIZERS



Odor Eliminators
Contain special ingredients that neutralize unpleasant odors and leave behind pleasant scents. Gallon sizes available in the following scents.

Cherry Scent	122201
New Car	122401
Xtrax Scent	122101
Gree Apple Scent	122301

Odor Eliminating Foggers
Can be used for total release fogging or spot spraying. These foggers are not cover-ups; they eliminate smoke and other strong odors at their source. Each 5 oz. can deodorizes up to 6,000 cubic feet of space. They are available in the following scents:

Xtrax	124123	Cinnamon	124122
Citrus	124121	New Leather	124124
Original Bubble Gum	124120	Actuator Tip	800151

ALL PURPOSE CLEANERS



Potent Purple™ Super Duty Cleaner & Degreaser
Designed to meet the greatest cleaning challenges at an economical price. This versatile, caustic cleaner will cut through the heaviest accumulations of grease and oily dirt and leave surfaces clean and film-free. Can be diluted up to 1:3.

5 gal.	120305
55 gal.	120355

GLASS CLEANERS



Glass Cleaner Concentrate
Fast-drying, easy-to-use formula can be diluted as necessary for year-round use. This powerful product dissolves road film, bugs and haze on glass, chrome and other hard glossy surfaces without leaving streaks or deposits.

1 gal.	105501
---------------	--------

Pink Mist™ Glass Cleaner
Removes all soils and film from glass, chrome, stainless steel, porcelain and ceramic tile. This ammonia-free formula can be diluted for greater economy.

1 gal.	170301
---------------	--------

Windshield Solvent Concentrate
Specially formulated, methanol-based mixture prevents solution from freezing. This non-foaming formula cuts through dirt and road film to leave windows clean and haze-free.

1 gal.	106701
5 gal.	106705
55 gal.	106755

RTU Glass Cleaner
Formulated to cut through tobacco film, soap scum and oily soils. This ammonia-free formula is ideal for non-porous, hard surfaces such as glass, tile, chrome, stainless steel, ceramics, porcelain, vinyl, plastic or rubber moldings.

1 gal.	107901
5 gal.	107905
55 gal.	107955

Foaming Glass Cleaner
Clings to glass for better cleaning. Special ammoniated formula cuts through haze and dirt to leave glass, chrome, appliances and stainless steel clean and streak-free. Not recommended for use on aftermarket tinted windows.

19 oz.	105520
---------------	--------

Glass Cleaner
Ammonia-free cleaner powers away grime and film to leave glass, chrome, tile and mirrors clean and streak-free. Safe for use on aftermarket tinted windows.

19 oz.	113820
---------------	--------

Foaming Carpet & Upholstery Cleaner
Features a special nozzle for vertical application. Its rich foam formula dries quickly. This makes cleaning of carpeting and seat bottoms fast and easy.

18 oz.	101720
---------------	--------

Spray Upholstery, Fabric & Carpet Cleaner
Removes soils and stains from all types of colorfast, fibered materials. Convenient, ready-to-use formula dries residue-free to prevent resoiling and leaves behind a fresh, clean scent.

22 oz.	101716
---------------	--------

Red Thunder® Biodegradable Cleaner and Degreaser
Removes a wide variety of soils from most hard and soft surfaces. This highly concentrated, non-caustic and aluminum-safe all purpose cleaner excels as an engine degreaser. It's also great on whitewalls, carpet and upholstery. Can be diluted up to 1:10.

1 gal.	102301
5 gal.	102305
55 gal.	102355

Clean & Shine
Clean & Shine powers away grease, grime and dirt from leather, vinyl and plastic while restoring a rich gloss to the surface. In just one step, this ready-to-use formula cleans, beautifies and protects. Meets all 2005 California and Ozone Transportation Commission (OTC) VOC standards.

22 fl. Oz.	125922
1 gal.	125901
5 gal.	125905



INTERIOR CLEANERS



Enzyme Cleaner
The newest innovation in stain removal for carpet and upholstery utilizes a patent-pending formulation technology and promicrobial action to enhance cleaning and provide long-lasting odor control. Highly effective on organic matter such as blood, vomit, urine and feces.

1 gal.	102901
---------------	--------

Instant Out, Spot & Stain Remover
Highly effective on both oil and water-based stains. This fast acting spotter removes tough spots and stains from carpet without rubbing or scrubbing. Use it to remove ink, grease, oil, cola, coffee, pet stains, shoe polish and lipstick.

19 oz.	126419
---------------	--------

Xtrax™ Carpet & Upholstery Cleaner
Features a special foaming all-fabric formula and the clean, fresh Xtrax fragrance. This easy-to-use product lifts soils without leaving an oily film behind. Use it for all carpet and upholstery cleaning.

18 oz.	124720
---------------	--------

Carpet & Upholstery Cleaner Concentrate
Lifts and dissolves soils and stains for complete cleaning. Carpet & Upholstery Cleaner can be used on synthetic and natural fiber carpet and upholstery. Can be diluted up to 1:20.

1 gal.	101801
5 gal.	101805

Carpet Plus™
Designed for horizontal application. This makes cleaning upright areas, such as seat backs, much easier. The cleaners in this aerosol do not leave behind sticky residues that can attract dirt and speed resoiling. This aerosol can also be used to clean headliners.

18 oz.	110220
---------------	--------

HAND CLEANER

Lotion Hand Cleaner
Cleans the dirtiest hands without solvents or abrasives. It contains a blend of anti-bacterial and skin-care ingredients to condition the skin and guard against infection.

1 gal.	102101
---------------	--------



AEROSOL DRESSINGS & CONDITIONERS



Shine-It™ Aerosol Dressing
Top grade silicone dressing/protectant. Shine-It leaves a deep, lasting shine on rubber, leather, vinyl, wood and painted surfaces. Its "fan-shaped" aerosol spray pattern can be positioned to discharge horizontally or vertically to dress difficult-to-reach areas.

11 oz.	111516
---------------	--------

Xtrax™ Interior Dressing
Xtrax Interior Dressing creates outstanding gloss on vinyl, plastic, rubber, leather and painted interior and exterior auto surfaces. Use this fine mist to shine hard-to-reach areas such as vents.

11oz.	124620
--------------	--------

Perfect 10™
Shines and protects vinyl, plastic, leather, rubber, metal and wood surfaces. A special blend of silicones and fast-drying solvents make treatment of intricate vent and dash surfaces easy. A super-fine mist coats surfaces evenly without sticky buildups.

12 oz.	114520
---------------	--------

SOLVENT-BASED SILICONE DRESSINGS



Blue Blazes™ All Purpose Premium Dressing
Produces a high-gloss shine on all plastic, rubber, vinyl and leather. Blue Blazes dries quickly to a non-sticky gloss and helps prevent fading, shrinking and cracking.

22 fl. oz.	114822
1 gal.	114801
5 gal.	114805
55 gal.	114855

Ultra Cote 2™ Premium Dressing
Restores gloss to weathered and oxidized vinyl, rubber, plastic and leather surfaces. The pleasant piña colada scent and rich, lustrous gloss make Ultra Cote 2 a good choice for classic performance at a reasonable price.

1 gal.	103001
5 gal.	103005

WATER-BASED DRESSINGS



Aqua-Bead Silicone Suspension Dressing
Aqua Bead is a VOC compliant, premium, water-based, silicone suspension dressing formulated to perform like a solvent-based dressing. Aqua Bead's high-gloss and durability combined with its superior water-repellant properties make it ideal for tires, engines, bumpers, trim and moldings. It's great on interiors too!!

1 gal.	129601
5 gal.	129605

Appeal™ Super Concentrated Dressing
Premium concentrated dressing that can be diluted up to 1:5. Create different levels of gloss ranging from a semi-gloss, satiny finish to a wet, dazzling shine. This durable, silicone-based, aqueous emulsion dressing offers ease of use and convenience.

1 gal.	118001
---------------	--------

SPECIALTY DRESSINGS



Clear Blue Dressing—VOC
This ready-to-use dressing provides durable, high-gloss shine. Use it to protect and preserve the beauty of interior and exterior surfaces.

1 gal.	125101
5 gal.	125105
55 gal.	125155

VOC Compliant Tire Nu Dressing
VOC Compliant Tire Nu is a non-silicone dressing formulated for use in body shops. It produces a dazzling, high-gloss shine on plastic, leather, vinyl and rubber and restores faded surfaces to a like-new finish.

1 gal.	125301
5 gal.	125305

SPECIALTY AEROSOLS



Aero Thunder All Purpose Cleaner
Powers through heavy grease and grime. This strong all purpose cleaner is designed to remove a wide variety of soils from both hard and soft surfaces. Use it to clean carpet, upholstery, whitewalls, engines and all painted surfaces.

19 oz.	126319
---------------	--------

Spray Citra Clean
Excels as an all-purpose cleaner with the added benefit of aerosol convenience. This versatile cleaner lifts and dissolves oily soil, making it the perfect cleaner for just about any washable surface.

19 oz.	108720
---------------	--------

XTRAX™ XTRACTION CHEMICALS



Xtrax™ Liquid Fabric Cleaner & Deodorizer

Designed for use in hot and cold extraction machines. This low-foam formula leaves carpet and upholstery clean, soft and fresh-smelling.

1 gal. 118701
5 gal. 118705

Xtrax™ Dry

Formulated with color-safe peroxide bleach to make stain and odor removal fast and easy. This carpet and upholstery cleaner is designed for use with hot and cold extraction machines.

10 lb. 118810
30 lb. 118830

XTRAX™ XTRACTORS



Malco's Xtrax™ Xtractors Feature:

- Rotomolded, cross-linked polyethylene for extreme durability
- Stainless steel solution tanks for outstanding heat retention, corrosion-resistance and durability
- Comprehensive warranty (The best in the business!)
- 15-amp operation so only one plug is needed
- Long solution and vacuum hoses (15' each) reach all corners of every vehicle
- Stainless steel hand tool
- 25' heavy duty extension cord
- Non-marking wheels
- Heavy duty motors and pumps

Model 1200 Xtrax™ Xtractor

Huge 9 gal. solution tank. Dual, two-stage vacuums create 150" of water lift and 100 psi of 190° F cleaning solution.

1 unit 800062

Model 600 Xtrax™ Xtractor

Large 4.5 gallon solution tank with 1500-watt heaters. Single, three-stage vacuum providing 137" of water lift and 60 psi solution pump. Lift-off recover tank for easy emptying.

1 unit 800184



Xtrax™ Stainless Steel Floor Tool

1 unit 800187

Xtrax™ Clear Nylon Hand Tool

1 unit 80027A

Xtrax™ Stainless Steel Hand Tool

1 unit 800185

Xtrax™ Stainless Steel Crevice Tool

1 unit 800139

ACCESSORIES

Cleaning Accessories

A. Hornet Wipeout Detailing Cloth	800135
B. Huck Glass Towels	810103
C. Hand Towels, Cotton	810044
D. Large Wash Mitt	810008
E. Round Wax Applicator Pad	800082
F. Square Wax Applicator Pad	810011
G. EZIDRY Auto Squeegee	810080
H. Foam Tip Cleaners (10/Pack)	810100
I. Doo-All Scrubber	810081
J. Hydra Wipe	810067
K. Water Sprite (5' in a tube)	800033
L. Large Synthetic Chamois	810010
M. Hornet Gray Scuff Pads	840002
N. 100% Cotton Polishing Cloth	800111

Bottles & Sprayers

O. 32 fl. oz. Spray Bottle	810082
P. 12 fl. oz. Polish/Ketchup Bottle	810038
Cap for 16oz. Polish Bottle	810034CAP
R. Malco Trigger Sprayer	800026
S. Solvent Resistant Trigger Sprayer	845001
T. Heavy Duty Trigger Sprayer	810026

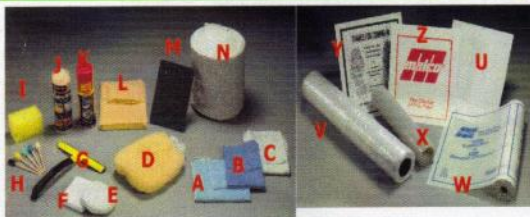

Floor Mats & Seat Covers

U. Unprinted Kodak Floor Mats (500 per roll)	800165
V. Plastic Seat Covers (500 per roll)	800030
W. Plastic Floor Mats (500 per roll)	800029
X. Self-Adhesive Floor Mats (100/roll)	800147
Y. Disposable Latex Floor Mats (500/case)	800163
Z. Kodak Floor Mats (500/case)	800164

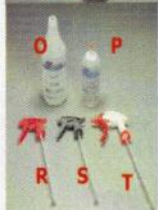

WHEEL & TIRE CLEANERS



Power Brite™ Concentrated Wire Wheel Cleaner

Cleans and shines chrome-plated surfaces in one easy step. Power Brite is an extremely strong acidic concentrate that removes rust, road dirt, brake dust and oily films. Not for use on aluminum or magnesium.

1 gal. 106001
5 gal. 106005

Ultra Shine™ Concentrated Mag & Aluminum Wheel Cleaner

Safe for clear coated and uncoated aluminum wheels. Fortified with grease-cutting surfactants and acids that cut through oxidation, road dirt and brake dust to leave wheels clean and looking like new.

1 gal. 105801

Whitewall Cleaner Concentrate

Removes dirt and grease to clean and brighten whitewalls and raised letters. Dilute 1:3.

1 gal. 100201
5 gal. 100205
55 gal. 100255

Complete Wheel & Tire Cleaner Non-Acid Formula

Hydrofluoric acid-free formula works quickly and leaves wheels and tires clean and bright. This ready-to-use product contains a unique blend of cleaners that dissolve and loosen burned-on brake pad dust, grease, oil and dirt from the entire wheel. Safe for use on all types of wheels.

1 gal. 122901
5 gal. 122905

Brake Off™ Non-Acid Wheel Cleaner

Removes brake dust, road film and dirt from aluminum and light alloy wheels. This powerful non-acid, alkaline cleaner is ideal for cleaning intricate cast and machined wheels, including Mercedes, Volvo and BMW aluminum and alloy wheels.

1 gal. 119401
5 gal. 119405
55 gal. 119455

SYSTEM I™

Controlling costs and quality is important to any business, but to a rental agency working on slim margins, cost containment is critical. The System I™ Cleaning Center dramatically reduces chemical costs per vehicle while improving cleaning quality by providing products in a hyper-concentrate form and by controlling the amount of product used to clean each vehicle.



SYSTEM I™ PRODUCTS

Car Soap Concentrate

Makes 900 gallons of car wash
5 gal. 115705

General Purpose Cleaner

Makes 55-105 gallons of cleaner
5 gal. 115605

Engine Degreaser

Makes 40-55 gallons of degreaser
5 gal. 115405

Dressing

Makes 15 gallons of RTU dressing
5 gal. 121305

Glass Cleaner Concentrate

Makes 85 gallons of RTU glass cleaner
5 gal. 115505

SYSTEM I™ HARDWARE

Select Six Plus™ Proportioner	800084
High Flow Single Proportioner	800086
Low Flow Single Proportioner	800085
Dressing Proportioner	800104
System I™ Cabinet	800052
System I™ Bottle Kit	810039

We are an authorized dealer and installer of Rotary and Challenger lifts. We can also supply you with any replacement cylinders, pads, arms, cables, accessories, etc. that you may need for your current lifts. We also sell tire changers, wheel balancers, compressors, etc. as well as used equipment.

Features and Benefits



Shown: SPOA10
10,000 lbs. capacity
asymmetrical lift



Shown: S10i
10,000 lbs. capacity
symmetrical lift with
inbay® package



Shown: S15i
15,000 lbs. capacity
symmetrical lift with
inbay package

Engineered for Productivity

For decades, Rotary® has been the recognized leader in vehicle service lifts. This legendary reputation has set the standard for quality, durability, reliability and attention to safety throughout the automotive service market.

Service and Support

With Rotary lifts, you have the service and support you need. Our world-wide network of service companies are always standing by.

Lift Safety Standards

Most of our lifts are third party tested by ETL and certified by ALI to meet or exceed strict ANSI standards such as cable cut and deformation tests. Be sure the lift you buy has the gold ALI/ETL label that assures your lift has been tested to meet these standards.

Key Productivity Features

The three-stage arm increases overall arm sweep and minimum arm reach to precisely lift vehicles that have:

- Uni-body construction**
- Visually marked pick-up points on the vehicle
- Wider vehicle treadwidth and lower profile (min. adapter height 4 3/4")
- A short or long wheelbase



Controls on each column with 110V electric and air outlets right on the lift make this two-post lift the ultimate choice for productivity seeking technicians and managers.



Higher Capacity!

10,000 lbs. capacity is standard on asymmetrical and symmetrical lifts!

Dual Controls!

inbay lifts have operation controls on each column



Shown: A10i
10,000 lbs. capacity
shown with inbay,
additional equipment and accessories

** To lift trucks and other frame type vehicles Rotary recommends using the FJ6182 adapter. Kit FJ6197



www.rotarylif.com



Increased Rise!

3" higher rise
(25 cubic feet*) increases technician workspace under vehicle!

Standard Rise on EH Models - 81"
Normal rise - 78"

3"

Technician Productivity Features

- Unlike most other lifts, Rotary® power units are designed, tested and built by Rotary, for Rotary lifts. We don't use 3rd party power units which are for universal applications.
- Adjustable height options on two-post column extensions gives you flexibility to lift and service taller vehicles.
- The patented "Double S" single piece construction column design provides a channel for the bearings to travel that maximizes the strength of the column and surface contact area of the bearing. 
- Slider block bearings of Tivar® 1000 polyethylene are self-lubricating and maintenance free. 
- High-pressure cylinders in each column provide maximum lifting force and smooth operation.
- Arm restraints make positioning of arms easy. They engage when the lift is raised and automatically disengage when the lift is fully lowered. 
- Overhead padded switch bar to prevent damaging a vehicle by raising it too high.

• Standard three-position flip-up adapters allow for quick and easy contact with pickup points on a variety of vehicles. We offer the highest standard adapter reach in the industry, often avoiding the need for additional adapters. Low profile arm design on all 10,000 lbs. capacity models (4 3/4" from floor to flip-up adapter min. height) accommodate more vehicles. 

* 25 cubic feet is based on an average sedan raised 3" higher than standard lift.



Standard Features and Benefits



Engineered for Productivity

For decades, Rotary® has been the recognized leader in vehicle service lifts. This legendary reputation has set the standard for quality, durability, reliability and attention to safety throughout the automotive service market.

Service and Support

Our sales force attends intensive training on our products and the issues that face service repair facilities. Rotary representatives can help you evaluate which lift best meets your needs. With a world-wide network of highly-trained Rotary Authorized Installers and Distributors, service support is always close at hand.

1/2" steel cable for greater lifting capacity

Non-skid surface allows sure grip of tires and a "sure foot" for technicians standing on the lift.

5/16" thick (SM014) steel one-piece runway with non-welded track that is part of the runway for strength and durability.

Filter/regulator/lubricator for clean, lubricated air which will extend the life of your lift and air powered tools.

The power unit is located in the front of the lift allowing us to place the latch air release on the same column. This allows the technician to work more efficiently in the bay and have better access to the controls. The universal bracket allows mounting on the front or the side of the column.

Unlike most other lifts, Rotary® power units are designed, built and tested by Rotary, for Rotary lifts.

Shown: SM014



14,000 lbs. capacity
shown with open front

www.rotarylif.com



Lift Safety Standards

A majority of our general service four-post lifts are third party tested by ETL and certified by ALI to meet or exceed strict ANSI standards such as 1.5 times rated capacity load test, engagement lock test, cable cut and deformation tests. Be sure the lift you buy has the gold ALI/ETL label that assures your lift has been tested to meet these standards.

Adjustable latch bars ensure the runways are level when resting on the latch bars at any of the multiple locking positions.



Redesigned one piece runways to handle higher capacity vehicles and longer wheelbases up to 212 1/2".

A dual function Sentinel Lock™ system features a patented (U.S. Patent No. 6,446,757) slack cable guide arm that stays "on guard" to manage the lock latch. In a slack cable situation, the lock system kicks the lock into position. Fewer parts means less opportunity for service issues and more peace of mind.

Locating the cylinder (no chains) under the runway eliminates any opportunity for vehicle door or mirror damage.

Protective strips on ramp ends eliminate floor gouging.

Automatic ramp chocks engage when the lift is raised. Clearance holes allow the ramp chocks to clear runways bolts with less noise on vehicle approach.

assistPRO™
professional facility planning assistance



Rotary works directly with you, your local distributor, equipment program managers and architects to develop an efficient and capable service area to fit your needs. Our assistPRO™ service provides:

- Product selection and analysis
- Vehicle turning radius and traffic flow analysis

- Customized layout for each facility with final drawings in the format of your choice
- Detailed CAD blocks available to architects
- CSI three-part written specifications
- Continuing education for architects

Look for us in ARCAT's Spec Wizard.



Standard Features and Benefits



NEW 14K Alignment Racks

The NEW 14,000 lbs. capacity alignment lift features redesigned runways, 1/2" thick steel cable in the columns, an air filter/regulator/lubricator and an internal airline. Extended lift models are available, accommodating wheel-bases up to 212 1/2", and four wheel alignments up to 158". Rotary's AR/ARO14 lifts are also compatible with the new technology alignment systems on the market today.

Service and Support

Our sales force attends intensive training on our products and the issues that face service repair facilities. Rotary representatives can help you evaluate which lift best meets your needs. With a world-wide network of highly-trained Rotary Authorized Installers and Distributors, service support is always close at hand.

NEW
1/2" steel cable for greater lifting capacity

Stainless steel turning radius gauges standard

5/16" thick (AR/ARO14) steel one-piece runway with non-welded track that is part of the runway for strength and durability.

Filter/regulator/lubricator for clean, lubricated air which will extend the life of your lift and air powered tools

Alignment lifts come standard with two 7,000 lbs. capacity rolling jacks.

Roll back bar allows the radius gauge to be placed in the front or back of the slot while keeping a flat runway surface.

The power unit is located in the front of the lift allowing us to place the latch air release on the same column. This allows the technician to work more efficiently in the bay and have better access to the controls. The universal bracket allows mounting on the front or the side of the column.

Shown: ARO14
14,000 lbs. capacity alignment rack shown with open front



Lift Safety Standards

Our Alignment Lifts are third party tested by ETL and certified by ALI to meet or exceed strict ANSI standards such as 1.5 times rated capacity load test, engagement lock test, cable cut and deformation tests. Be sure the lift you buy has the gold ALI/ETL label that assures your lift has been tested to meet these standards.

Adjustable latch bars ensure the runways are level when resting on the latch bars at any of the multiple locking positions.

NEW

Longer slip plate redesigned to accommodate four wheel alignments up to 158"

Non-skid surface allows sure grip of tires and a "sure foot" for technicians standing on the lift.

A dual function Sentinel Lock™ system

features a patented (U.S. Patent No. 6,446,757) slack cable guide arm that stays "on guard" to manage the lock latch. In a slack cable situation, the lock system kicks the lock into position. Fewer parts, less opportunity for service issues and more peace of mind.

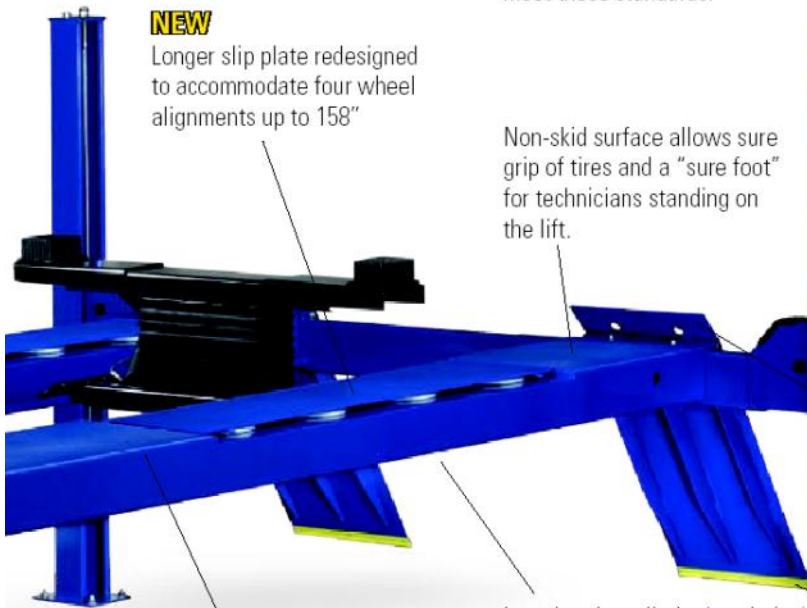

Automatic ramp chocks engage when the lift is raised. Clearance holes allow the ramp chocks to clear runway bolts with less noise on vehicle approach.

NEW

Redesigned runways to handle higher capacity vehicles and longer wheelbases up to 212 1/2"

Locating the cylinder (no chains) under the runway eliminates any opportunity for vehicle door or mirror damage.

Protective strips on ramp ends eliminate floor gouging.

assistPRO™
professional facility planning assistance



Rotary works directly with you, your local distributor, equipment program managers and architects, using the latest tools and techniques, to develop an efficient and capable service area to fit your needs. Our assistPRO™ service provides:

- Product selection and analysis
- Vehicle turning radius and traffic flow analysis

- Customized layout for each facility
- Detailed CAD blocks are available to architects
- Final drawings in the format of your choice
- Written specifications for approval and quoting process
- Continuing education for architects



Standard Equipment

Rolling Jacks

Increase your service opportunities with hydraulic operating rolling jacks by lifting front, rear or all wheels off the runways for brake, tire, suspension and two or four-wheel alignment work. (Two RJ7000 rolling jacks come standard with AR/ARO series lifts.)



Shown: RJ7000
7,000 lbs. capacity
4,500 lbs. capacity also available

Alignment Equipment

Your AR/ARO14 alignment rack comes standard with 2 rear slip plates and 2 stainless steel turning radius gauges that are compatible with the new technology 3-D alignment equipment on the market today.



Internal Airline

Standard Internal airline connections let two rolling jacks operate simultaneously, and provides air outlet on the runway.



Air Filter/Regulator/Lubricator

The AR/ARO14 comes standard with a filter/regulator/lubricator for clean, lubricated air which will extend the life of your lift and air powered tools.



Standard/Optional Features

Standard Feature	●
Optional Feature	○

Feature	AR14	ARO14
14,000 lbs. Capacity	●	●
ALI Certified	●	●
Open-end design		●
Cylinder located under the runway	●	●
Dual function Sentinel Lock™ System	●	●
Air filter/regulator/lubricator	●	●
Multiple runway lengths available (S, L & EL)	○	○
Adjustable latch bars	●	●
One piece non-welded runway	●	●
Power unit on front column	●	●
Internal airline and air tool connection	●	●
Comes with rolling jacks, stainless steel radius gauges, rollback bar and rear slip plates	●	●
Compatible with the new technology alignment systems on the market today	●	●

Optional Accessories

Swing Air Jacks

Swing air jacks add versatility and utility to your lifts enabling technicians to do a wider variety of service work at their current locations.

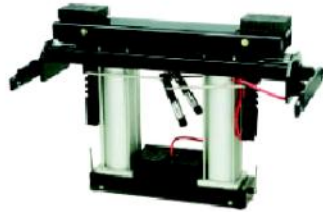

Shown: SJ6000
6,000 lbs. capacity swing air jack pivots and lays flat between the runways when not in use

Oil Drain Pan

Low profile rolling drain pans with splash guard, drain valve and dust cap. An eight foot oil drain hose with quick connect fitting is also available.



Air/Electric Utility Box

- Two 110v electric outlets and air connection
- Mounts easily on any column and provides quick access to utilities
- The filter/regulator/lubricator helps extend the life of your air tools



Ramp Kits

- Allows for drive-thru capability
- Oil resistant, non-skid coating
- Includes two ramps and hardware
- Extended length also available.



Removable Work Steps

Fits all four-post lifts. Support lugs bolt to runways (drilling and tapping required).



Additional Lift Models *revolution*

Revolution® brand four-post lifts are your source for residential storage and maintenance.

Professional grade lifts built by Rotary - specifically designed for the home enthusiast.

- Storage -Double your garage parking capacity
- Versatility - Store almost anything including lawn mowers, boats, bicycles etc. on top to make more room in your garage
- Two wheelbase options available

General Service Four-Post Lifts

- **NEW** 14,000 lbs. capacity
- Air filter/regulator/lubricator keeps your air clean and regulated to extend the life of your air tools
- Cylinder located under the runway to eliminate any opportunity for vehicle door/mirror damage
- Locking latches every 3 inches with patented Sentinel Lock™
- Non-skid surface on runways
- Open front design available
- Bolt-on alignment kit available
- Three wheelbase length options

Heavy-Duty Four-Post Lifts

Rotary® Heavy-Duty Four-Post lifts are a great value, an investment that is easy to own and operate because they are engineered to perform and built to last. Our heavy-duty lifts accommodate a wide range of vehicles, making routine vehicle service and maintenance with a Rotary four-post lift just the ticket.

Take advantage of the quick set-up for undercarriage repairs and wheel service maintenance. These four-post lifts are proven, durable and require little to no maintenance. (Available capacities: 18,000, 30,000, 40,000, 50,000 and 60,000 lbs.)



Shown: RFP7-XLT
7,000 lbs. capacity



Shown: SM014L
14,000 lbs. capacity with optional rolling jacks



Shown: 40000HDL
40,000 lbs. capacity



Features and Benefits

CL10series

10,000 lb. capacity



- 1** Maximize service capabilities and revenue potential
- 2** Reduces stress on equalization system and increases cable life
- 3** Decreases load on bearing
- 4** Allows lift to be placed in standard service bay with 12' ceiling
- 5** Prevents vehicle damage from being raised too high
- 6** Reduces column deflection
- 7** Allows technician to disengage both columns simultaneously

 The Automotive Lift Institute (ALI) certifies that the CL10 described herein complies with the applicable provisions of the American National Standards ANSI/ALI ALCITV 2006 and are Third Party Validated by the ETL Testing Laboratory.

CL10 — offset 2-stage arms



- » Wide arm sweep with excellent arm retraction and reach
- » Meets OEM recommended pick up points of most vehicles
- » Offset front arms provide single sweep spotting of virtually any vehicle
- » Lifts vehicles with a symmetric center of gravity



Versymmetric® Technology

The CL10's specially engineered Versymmetric® arms safely lift both symmetrically and asymmetrically within the same service bay.



Features and Benefits

HD 2-Post

12,000 lb., 15,000 lb., & 18,000 lb. capacities

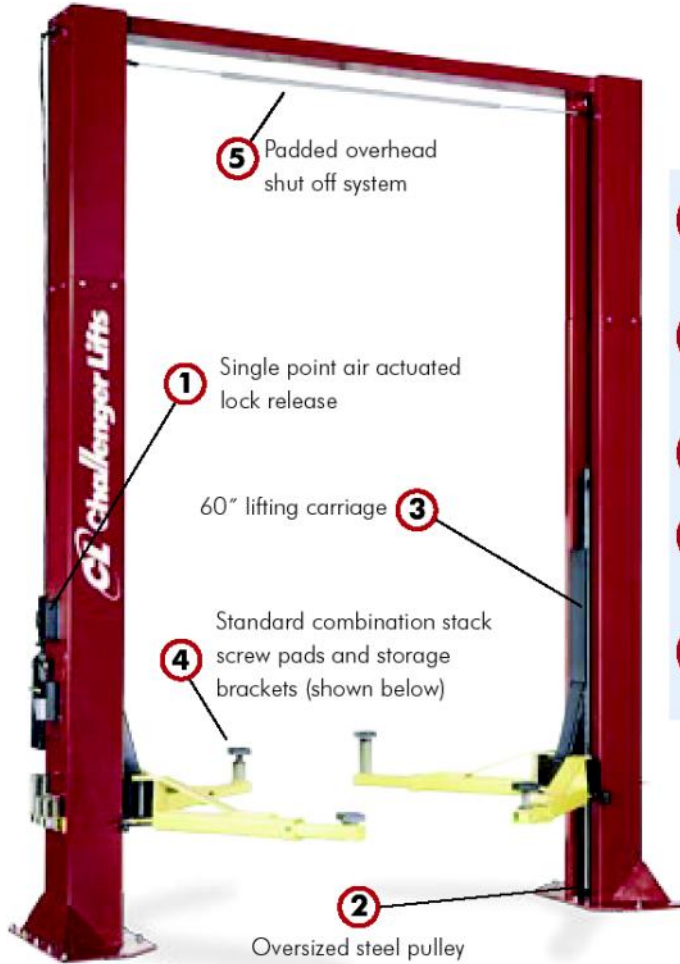

- 1 Allows technician to disengage both columns simultaneously
- 2 Reduces stress on equalization system and provides increased durability
- 3 Lessens column stress by dispersing load
- 4 Accommodate a wide range of vehicle pick up points
- 5 Prevents vehicle damage from being raised too high



The Automotive Lift Institute (ALI) certifies that the Heavy Duty 2-Post Lifts (12000, 15000, & 18000 series) described herein complies with the applicable provisions of the American National Standards ANS/ALI ALCV 2006 and are Third Party Validated by the ETL Testing Laboratory.

Maximize Productivity

Our single push button power unit raises lift and a release valve handle lowers it.

Challenger's arm restraints automatically disengage when lift is fully lowered for easy positioning of arms and securely engage when lift is raised.

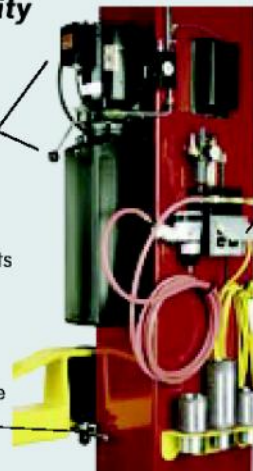

Turn your lift into a workstation with our optional air/electric service station. (Part#: B10264)

Our single piece adapter organizer prevents adapters from being misplaced.



Standard Stack Adapters

Challenger Lifts Heavy-Duty lifts come complete with 4 standard adapters, 4 medium extensions, and 2 high extensions to reach a wide range of vehicle pick up points.



Features and Benefits

40series

12,000 lb. capacity

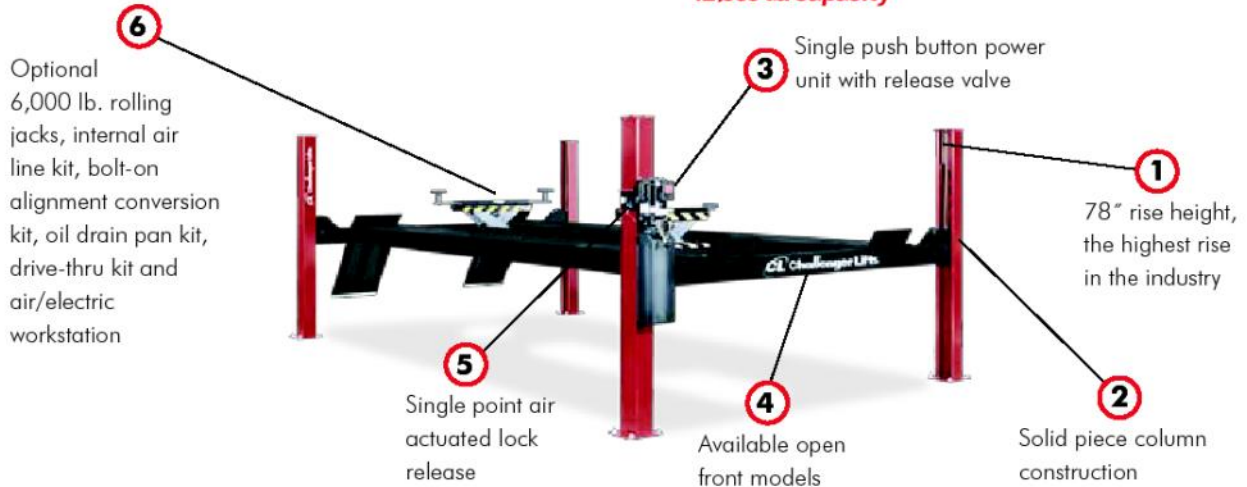

The Automotive Lift Institute (ALI) certifies that the 40series Lifts described herein complies with the applicable provisions of the American National Standards ANSI/ALI ALCTV 2006 and are Third Party Validated by the ETL Testing Laboratory.

- 1 Provides maximum head room for working underneath vehicles
- 2 Provides rigidity and stability for rigorous servicing needs
- 3 Provides convenience and safety when lifting and lowering vehicles

- 4 Enable easy access to front end service
- 5 Allows technician to disengage all four columns simultaneously
- 6 Provides complete optimization for your 4-Post servicing needs

Open-Front Models

Challenger Lifts' 40series 4-Post lifts are available in open-front models. This configuration allows easy access for front end work and provides unobstructed workflow.



Rolling Jacks - RJ6

Optional 6,000 lb. capacity rolling jacks allow brake and wheel access, broadening potential service revenue.



Features and Benefits

AR40series

12,000 lb. capacity

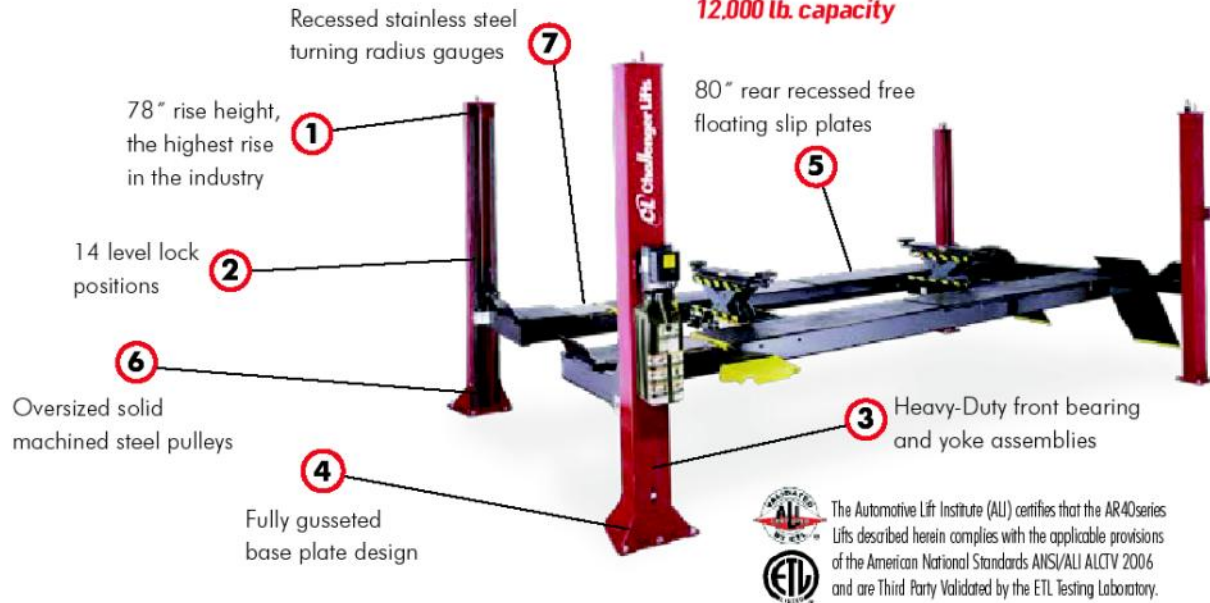

- 1** Provides maximum head room for working underneath vehicles
- 2** Allows technician to work at an ergonomic working height to increase productivity and minimize fatigue
- 3** Distribute contact load to reduce column stress for longer product life

- 4** Reduces column deflection
- 5** Offer a wider range of 4 wheel alignment capacities
- 6** Prolong pulley and cable life
- 7** Provide more precise alignment readings

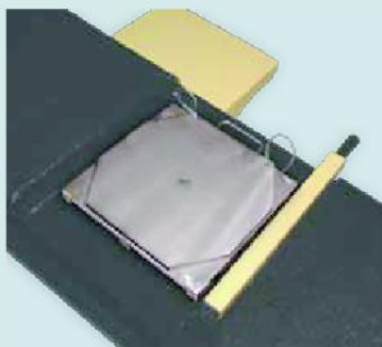

Stainless Steel Radius Gauges

Challenger Lifts' AR40series alignment racks come complete with corrosion resistant stainless steel turning radius gauges. These gauges are compatible with today's latest 3D alignment systems.



Rolling Jacks - RJ6

Two 6,000 lb. capacity rolling jacks are included providing the complete alignment package.

COATS



Model 5040 Tire Changer

The Coats 5040A/E Rim Clamp® is a highly capable, cost effective tire changer for today's busy shops.

Clamps Wheels Externally Up to 21".

Wheels keep getting bigger and more easy to damage. The Coats 5040A/E allows you to service larger assemblies up to 21" while providing the speed you need to keep the work moving through the shop. **So you can work quickly on a variety of applications.**

The Power You Need at Every Step.

The 5040 has conveniently-placed foot pedals that give you precise control over every step of the changing process. The Coats 1.5 hp motor (air model) helps smoothly install performance tire beads without damage. A powerful bead loosener has three support blocks and a sculpted blade to make quick work of even the most stubborn tires. **Smooth operation provides faster floor to floor times and "on times".**

Legendary Performance.

The Coats Rim Clamp® platform has become the industry standard for speed, durability, and ease of use. **Count on your shop staying more productive, year after year.**

Protect Those Expensive, Delicate Wheels.

The Coats 5040A/E provides protection for wheels at **every step of the process.** Bead loosener socks, clamp booties, and lift tool protection prevent metal-to-metal contact that causes scratching or marring.

- 1 **High Torque X-Shaped Turntable (Air or Electric)**
Pedal controlled for more careful tire mounting/dismounting or high volume. Lessens the risk of tire damage.
- 2 **Built in Bead Sealing Jets**
Quickly seals even loose beads while tabletop inflation provides faster workflow.
- 3 **Coats X-Shaped Tabletop**
Holds wheels firmly in place during operation.
- 4 **Manual Swing Arm**
Adjusts horizontal tool head position. Spring assisted vertical height adjustment locks in place with lever.
- 5 **Powerful 1.5 HP Motor**
This air drive system provides plenty of power plus infinite wheel control.
- 6 **Pressure Limiter**
For inflation control and enhanced safety.
- 7 **Bead Loosener**
Three support blocks and sculpted blade provide wheel protection and ensures contact with tire beads at the proper angle.
- 8 **Inflation Gauge**
Easy to read gauge accurately displays tire pressure.
- 9 **Compact Chassis**
Fits easily into limited space applications.



COATS**MODEL 5040A/E
TIRE CHANGER****Wheel Capability**

Steel, many alloys, and some performance applications.

Tool Head Offset Adjustment

Spring assisted lift, set back, and lock.

Shape of Tabletop

"X"-shaped for rigid perimeter support of the wheel.

Wheel Clamping Method

Four self centering clamps in table top actuated by pneumatic cylinder.

Bead Loosening System

Foot control actuates cylinder that handles wheels up to 10.5" wide.

Electric Drive System

110v, 30A single phase.

Pressure Limiter

Standard.

Bead Seating Reservoir

3.4 gal. separate tank, pressure protected.

Inflation Gauge

Easily calibrated 0 to 60 PSI gauge with protection to 200 PSI. Damage resistant Lexan faceplate.

Filter Lubricator

Standard with automatic drain and large capacity lubricator bowl.

Clamping Range

10" - 21" External.
12" - 24" Internal.

Maximum Tire Width

10.5 inches.

Maximum Tire Diameter

50 inches.

Required Air Source

110 to 175 PSI
14 to 15 SCFM at 150 PSI

Chassis Footprint

35" wide x 44" deep x 70" high.

Shipping Weight

585 lbs.

An ideal volume tire changer that handles routine jobs faster and many performance applications.

Flexibility is the key to success.

The Coats Model 5040A/E Tire Changer is designed to work on a wide variety of applications, including virtually all OE fitments. Available in air (A) or electric (E) drive, the Model 5040A/E is the latest platform in the shop proven, Coats Rim Clamp® Tire Changer line. The 5040A/E provides the best value and performance in its class whether you are just entering the tire business or need another changer to add critical capacity.

Even if you have never used a Coats Rim Clamp® Tire Changer before, you and your crew will feel right at home on this straightforward, easy to operate machine. All the controls are logically placed for stationary work without excess reaching, walking, or bending. This means you can turn more jobs in a day— and turn profits upward.

The Capacity You Need

Easier operation and simpler control selection.

**X-Shaped Table Top**

Handles the biggest custom tire and wheel assemblies.

**Logical Pedal Controls**

Makes it easier for the operator to select the right pedal operation for desired function.

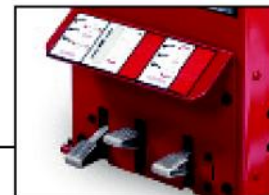
**Protection Accessories**

Bead loosener, tire tool, and clamp booties provide an extra measure of protection for delicate alloy wheels.

**HENNESSY**

Manufacturer of Ammco®, Coats® and BADA® Automobile Service Equipment, Tools and Accessories.

1601 J.P. Hennessy Drive
LaVergne, TN 37086-3565
800-688-6496 or 615-641-7533

Hennessy Canada

2430 Lucknow Drive, Unit #9
Mississauga, Ontario L5S 1V3
905-672-9440 Printed in USA.

www.ammcoats.com

Part No. 941275 Rev.2 5/09

COATS

VERSATILITY

SPEED

5040 A/E Rim Clamp®

The 5040A/E is a highly capable, cost effective changer designed to service a variety of applications- including most OE fitments.

- Clamps wheels externally up to 21".
- 1.5 HP air drive or 1.0 HP Electric motor.
- Pedal activated X-shaped tabletop, clamps and bead loosener.
- Perfect choice for busy shops who require flexibility and volume.

Speed: Self centering clamps and bead loosening system add speed through simple operation.

Accuracy: Precision gauges mean accurate inflation, and our X-shaped tabletop provides the right clamping pressure for even the most delicate alloy wheels without damage.

Durability: Super-tough fiber reinforced composite air cylinders virtually never wear out. Bead loosener has extra support blocks for extra protection and durability.

Ease of Use: Foot controls are positioned for easy access. Built-in bead sealing jets and table top inflation simplify job completion.

5000 Series Tire Changers

Our 5000 Series Tire Changers are the workhorses of the tire service business. They're easy to use, incredibly durable, and fast.



5065 AX/EX Rim Clamp®

The 5065 AX/EX is the industry standard for tire service because of its speed, versatility, and value. You may also add an Inflation Guard for additional operator protection.

- Exclusive pedal-actuated X-shaped tabletop provides support for the most delicate wheels.
- Handles broad range of wheels and tires, from 6" to 26" in diameter and rims up to 14" wide.
- One-control manual swing arm adjusts horizontal tool head position while easy second control adjusts vertical height.
- 1.5 HP air drive system provides plenty of power plus infinite wheel control.
- Extra storage places everything at operator's fingertips.
- The extended tabletop services a broader range of wheels.
- Bead loosener has three support blocks for extra protection and durability.
- Built in bead sealing jets and tabletop inflation for faster work.
- Easy operation allows for fast training and high productivity.



5000 SERIES TIRE CHANGERS

ACCESSORIES

See accessory catalog or web for more choices.



New extended reach Robo-Arm™ retrofit can make changing low profiles and runflats fast and almost effortless. (#85009943)



Bump-N-Roll saves time and effort in bead loosening by making it easy to put heavier wheels in place. (#8183491)



Bead loosener and lift tool socks help give you total alloy wheel protection from start to finish.



X-Out-clamps externally clamp wheels from 13 to 24 inches. (#8184327)



Optional inflation guard kit helps protect operator in case of tire explosions. (#8184177)

HENNESSY MANUFACTURING, INC.
 Manufacturer of Ammco®, Coats® and BADA® Automobile Service Equipment, Tools and Accessories.
 1601 J.P. Hennessy Drive
 LaVergne, TN 37086-3565
 800-688-6496 or 615-641-7533
Hennessy Canada
 2430 Lucknow Drive, Unit #9
 Mississauga, Ontario L5S 1V3
 905-672-9440 Printed in USA.

www.ammcoats.com
 Part No. 941065 Rev.5 05/09

Note: "A" designation = Air Drive "E" = Electric Drive
 "AX" = Air Drive/Extended Tabletop.
 "EX" = Electric Drive/Extended Tabletop.

FEATURES to be compared

	5065 AX & EX	5040 A & E
WHEELS HANDLED: Alloy and steel	•	•
MOUNT/DEMOUNT MECHANISM: Manually swings away from wheel	•	•
TOOL HEAD OFFSET: Manual	•	•
X-SHAPED TABLETOP: For perimeter support of wheel	•	•
EXTENDED TABLETOP: For rims up to 22" external, 26" internal	•	
CLAMPING: Four wheel clamps actuated by 3-3/4" fiber/composite cylinder	•	•
BEAD LOOSENING SYSTEM: Foot control; handles wheels 2" to 12"		•
Foot control; handles wheels 2" to 17"	•	
DRIVE SYSTEM OPTIONS: 1.5 HP air drive	•	•
110v single phase-60 cycle electric drive	•	•
PRESSURE LIMITER: Standard	•	•
BEAD SEATING RESERVOIR: 3.8 gal. capacity in vertical tower	•	•
INFLATION GAUGE: Permanent in upper tower, 0 to 60 PSI	•	•
AIR SUPPLY GAUGE (CAL OSHA): 0 to 300 PSI	•	•
WATER FILTER: Standard	•	•
STORAGE TRAY: Standard	•	
Optional		•
INFLATION GUARD SYSTEM: Standard		
Optional	•	•

SPECIFICATIONS

	5065 AX & EX	5040 A & E
Rim Diameter	6"-22" External; 8"-26" Internal	10"-21" External; 12"-24" Internal
Rim Width	14" Max	10-1/2" Max
Tire Diameter	50" Max	50" Max
Drive System	Air and Electric	Air and Electric
Air Source	110 to 175 PSI 14 to 15 SCFM @ 150 PSI	110 to 175 PSI 14 to 15 SCFM @ 150 PSI
Chassis Footprint	35"w x 44"d x 75"h	35"w x 44"d x 70"h
Shipping Weight	585 lbs.	585 lbs.

Specifications subject to change without notice. Units may not be exactly as pictured.

GOATS



Model 775

- 1 **Integrated LED Matrix Display**
Easy-to-read visual cues and keypad promote proper balancing techniques and faster bay turnaround times.
- 2 **10 Balancing Modes**
Multiple static, dynamic, and alloy modes.
- 3 **Self-Calibrating**
Provides balancing accuracy within 1/100 of an ounce.
- 4 **Space Saving Design**
Put your balancing station virtually anywhere.
- 5 **Tape-A-Weight and Hidden Weight Capability**
Comes standard on both platforms.
- 6 **40 mm Shaft**
Uses all standard Coats accessories!

Model 875

- 7 **Automatic Distance & Diameter Entry**
Automatic measurement of two parameters with manual control back-ups.
- 8 **Auto Start Hood**
Balancing cycle begins when you lower the hood.
- 9 **Expanded Storage**
A 17-pocket weight tray provides easily reachable, abundant storage.
- 10 **Direct Tape-A-Weight Placement**
Audible beep guides you to perfect placement, every time.

Model 875 & 775 Wheel Balancers

Discover Coats® Light and Medium Duty Balancers.

These little dynamos get you started in a big way.

Offering wheel balancing to your customers is a great way to add new revenue to your business. You stay more competitive and keep balancing service in your shop... where it belongs.

The Coats® 775 is a great place to start. This unit is designed for low volume occasional balancing of OE fitments but offers features you will find on much more elaborate machines.

The Coats® 875 offers a step up to medium volume of OE fitments with more features like Automatic Distance & Diameter Entry and Direct Tape-A-Weight Placement—so you speed up your process to meet increasing demand.

Both of these innovative balancers will give you years of rugged durability, dependability, and performance... all for a value price.

Integrated LED Matrix Display

With a convenient, easy-to-read keypad entry system and self calibration accuracy within 1/100 of an ounce, balancing is fast and efficient even for a rookie. Can handle standard OEM tires up to 40" diameter and 100 lbs. (130 lbs. on the Model 875)

Space Saving Design

The 775 and 875 balancers are "small footprint" so they will fit almost anywhere. That also gives you the flexibility to fine tune your workflow process as you grow more easily.

Tape-A-Weight and Hidden Weight Capability

These features, usually found on much bigger balancers, come standard on both models. These modes help keep weights out of sight for OE alloys.



Model 775



Model 875

Direct Tape-A-Weight Placement

Audible beeps indicate exact placement of Tape-A-Weights and take the guesswork out of those tricky behind-the-spoke balances.

Automatic Distance & Diameter Data Entry

Automatic offset and diameter measurements make every balancing job quick and precise.

Hood with Integrated Auto Start

Lowering the protective hood starts the balancing process and offers additional protection.



MODEL 775 & 875 WHEEL BALANCERS

Specifications

- Part Number**
85007775 (Model 775)
85008875 (Model 875)
- Balancing Modes**
10
- Maximum Tire Diameter**
34" to 40"
- Rim Width**
2" to 20"
- Rim Diameter**
Up to 30"
- Maximum Tire Weight**
100 lbs. to 130 lbs.
- Shaft Diameter**
40 mm
- Balancing Speed**
100 RPM
- Motor**
110v, 1Ph
- Shipping Weight**
198 lbs. (Model 775)
213 lbs. (Model 875)

Standard 40 mm Accessories

- Small Cone
- Medium Cone
- Large Cone
- Light Truck Back Cone
- Calipers
- Premium Wheel Weight Hammer
- Hub Nut
- Small Pressure Cup & Rubber Lip
- Spring
- Stub Shaft

Optional 40 mm Accessories

- Slide Nut Kit - 8113328
- In-Between Cone Set - 8113795
- Light Truck Front Cone Kit - 8113277C

HENNESSY INDUSTRIAL, INC.

Manufacturer of Ammco®, Coats® and BADA® Automobile Service Equipment, Tools and Accessories.
1601 J.P. Hennessy Drive
LaVergne, TN 37086-3565
800-688-6496 or 615-641-7533
Hennessy Canada
2430 Lucknow Drive, Unit #9
Mississauga, Ontario L5S 1V3
905-672-9440 Printed in USA.

www.ammcoats.com
Part No. 85008943 Rev.1 11/07

The Coats® 775 and 875 Balancers bring professional balancing service to your lineup.

Whether you own a brake shop, muffler shop, or are just starting out with a couple of bays, the 775 and 875 models are a cost effective way to provide wheel balancing for your customers. It is a profitable part of any shop that can pay for itself in short order while encouraging repeat business. And Coats® will help you get started without breaking the bank. These models offer big league features in a compact size and the built-in dependability from the leader in the tire service business – Coats.



Integrated LED Matrix Display
Model 875



Integrated LED Matrix Display
Model 775



Auto Start Hood



17-Pocket Weight Tray

FEATURES to be compared	MODELS	
	775	875
SELF-CALIBRATING	●	●
AUTOMATIC DISTANCE & DIAMETER ENTRY		●
HOOD START		●
TAPE-A-WEIGHT CAPABILITY	●	●
HIDDEN WEIGHT CAPABILITY	●	●
DIRECT TAPE-A-WEIGHT PLACEMENT		●
WHEEL GUARD		●
BALANCER SHAFT: 40 MM	●	●
MAX TIRE WEIGHT: 100 LBS.	●	
130 LBS.		●
SHIPPING WEIGHT: 198 LBS.	●	
213 LBS.		●
OZ/GRAM SELECTABLE	●	●

COATS Tire Service Solutions

A Solid High Volume Solution

The Model 1000 Balancer has the mechanical and electronic power to be a key tool in high volume shops.

- 1½ horsepower direct-drive motor and 16-bit microprocessor provide super-fast five second cycle times.
- Eight separate balancing modes (static and dynamic modes, RV and four different alloy modes, plus match mount).
- Operator "A" and "B" feature so two technicians can use at once.
- Convenient keypad entry
- Keyboard activated "hood start"
- Ounce/gram selectable readings with roundoff.
- Self calibration.
- Ergonomic weight and adapter storage.



SPECIFICATIONS:

Balancing Modes:	8
Tire Diameter:	Up to 40"
Rim Width:	2" to 19.9"
Max. Tire Weight:	150 lbs.
Shaft Diameter:	28mm
Shaft Length:	6-5/8"
Resolution (Oz.):	0.01
Resolution (Degrees)	1.4
Accuracy (Oz.):	.01
Power Requirement:	220v AC 1-3 Phase
Footprint:	57" w x 50" d
Shipping Weight:	586 lbs.

HENNESSY INDUSTRIES, INC.

Manufacturer of Ammco®, Coats® and BADA® Automobile Service Equipment, Tools and Accessories

1601 J.P. Hennessy Drive LaVergne, TN 37086-3565 800-688-6496 or 615-641-7533

Hennessy Canada: 2430 Lucknow Drive, Unite 9, Mississauga, Ontario L5S 1V3 905-672-9440

www.ammcoats.com

COATS XR SERIES WHEEL BALANCERS

THE ULTIMATE RIDE MANAGEMENT SYSTEM

The Coats XR Series offers a total balancing solution - minimizing downtime, maximizing shop productivity, and delivering years of dependable service.

All Coats XR Series Balancers come fully equipped with the following:



SIMPLE, INTERACTIVE USER INTERFACE

Speeds technician input and mode selection.

POSITIONING PEDAL

Clamps wheel into stable position for easy weight placement.

2-D OR 3-D AUTO DATA ENTRY

Collects parameters for analyzing balance. Just drop the hood and the balancer begins its cycle.

DIRECT TAPE-A-WEIGHT® LOCATOR

Eliminates guesswork. Can do most Tape-A-Weights in just one spin.

SLIDE NUT

For faster mounting, automatically starting when the hood is dropped.

12 BALANCING MODES

Several alloy options, behind the spoke (the best in class), lug patch balance, and PAX.

MULTIPLE OPERATOR FEATURE

Allows up to four techs to work at once.

CUSTOMIZABLE ADAPTER KITS

MUST PICK ONE. Pick the adapter kit that best fits your shop. (See listing on back for further details.)



Real-time 3-D Data

Real-time 3-D animated graphics and visual cues provide a simple user interface that promotes proper balancing techniques and faster floor-to-floor times.



Adapter Tree

All models utilize the adapter tree next to the hood for convenient storage.



Static on Screen™ Display

Simultaneous display of static and dynamic data identifies any excess residual static imbalance.



coats.

FEATURED ITEMS

Model XR 1750

The affordable balancing solution

The Coats XR 1750 is the cost-effective solution for shops needing operator convenience and speed, without diagnostics.

- Highly accurate width sonar system on 3D and 3Di versions.
- Video display for clear instructions and weight placement.
- Flexible for either top dead center or direct weight placement, your choice.
- Three Configuration Options:
 XR 1750-3Di: 3-D auto data entry, onboard inflation, and all standard features.
 XR 1750-3D: 3-D auto data entry and all standard features.
 XR 1750-2D: 2-D auto data entry and all standard features. Value priced.



Model XR 1800

Ultimate balancer performance with diagnostics

The Coats XR 1800 is sensitive enough to solve the most complex balancing challenge, and tough enough to use all day long.

- Diagnose vibration issues beyond balancing with automatic radial run out sensor.
- 2-3 second diagnostic cycle time - fast enough to use with every balance.
- Highly accurate sensor system replaces an outer arm, increasing productivity and reducing machine wear.
- Onboard inflation for quicker rotation and balance jobs.
- Optional XR 1800-EB with Econo Balance.



Model XR 1850

The total ride management system

The Coats XR 1850 Ride Management System provides both radial and lateral runout diagnostics, extending the performance of our award-winning XR 1800.

- Complete diagnostic suite for radial runout and other key issues.
- 2-3 second diagnostic cycle time - fast enough to use with every balance.
- On-board printer allows you to keep a permanent record of serviced wheels.
- A simultaneous display of static and dynamic data identifies any residual imbalance.
- Onboard inflation for quicker rotation and balance jobs.
- Adapter storage tree, high-volume weight tray, and side storage pegs mean accessories are easily reachable.
- Includes Econo Balance mode.



COATS XR SERIES WHEEL BALANCERS

XR SERIES SPECIFICATIONS

	XR 1750 (All)	XR 1800	XR 1850
Balancing Modes	12	12	12
Tire Diameter	Up to 44"	Up to 44"	Up to 44"
Rim Width Range	2" to 20"	2" to 20"	2" to 20"
Maximum Tire Weight	160 lbs.	160 lbs.	160 lbs.
Shaft Diameter	40mm	40mm	40mm
Shaft Length	8-5/8"	8-5/8"	8-5/8"
Resolution (Round Off Mode)	0.01 oz, position 1.4	0.01 oz, position 1.4	0.01 oz, position 1.4
Power Requirements	115v, 1ph @ 50/60 Hz	115v, 1ph @ 50/60 Hz	115v, 1ph @ 50/60 Hz
Auto Parameters	Distance/Diameter/Width on 3D & 3Di	Distance/Diameter/Width	Distance/Diameter/Width
Width Sonar	on 3D & 3Di	Yes	Yes
Stop on Top	Yes	Yes	Yes
Radial Runout	No	Yes	yes
Lateral Runout	No	No	Yes
Footprint	60" w x 52" d	60" w x 52" d	60" w x 52" d
Shipping Weight	680 lbs.	685 lbs.	690 lbs.
Interface	LCD Video	LCD Video	LCD Video
Printer	No	No	Yes

XR SERIES PART NUMBERS

	XR 1850	XR 1800	XR 1750
Models with EB	85606451	85606447	
Premium 3Di		85000011	850000124
Fast 3D			850000129
Base 2D			850000123

XR SERIES AVAILABLE ADAPTER KITS

Coverage Required	Passenger Cars (Package 1)	Passenger Cars and Light Trucks (Package 2)	Passenger Cars, Light and Medium Duty Trucks (Package 3)
Standard Cone Kit 4 Cones 1.75" - 5"	•	•	•
Wheel Weight Hammer	•	•	•
Calipers	•	•	•
40mm Pin Plate System		•	•
Application Chart		•	•
Hole Gauge		•	•
Balancer Mate Storage System		•	•
Light Cone Truck Kit: 4.8" - 6.8" (8113277)			•
Balancer Chuck			•
Adapter Kit Part Number	8113428	8113593	8113594

XR SERIES PACKAGE 1



XR SERIES PACKAGE 2



XR SERIES PACKAGE 3



OPTIONAL ACCESSORIES

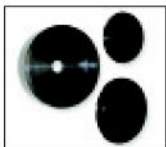

Deep Offset Kit
8113042

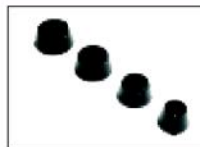

In-Between Cone Set
8113795

COATS.

Coats, We're Changing More Than Tires!

www.ammcoats.com

Part No. 85606509
© 2009 Hennessy Industries, Inc.

1601 J.P. Hennessy Drive, LaVergne, TN 37086 (800) 688-6496 or (615) 641-7533
Hennessy Canada: 2430 Lucknow Drive, Unit 9, Mississauga, Ontario L5S 1V3 (905) 672-9440



CEMB
BALANCING MACHINES

SM 815 RIM CLAMP TIRE CHANGER



CEMB USA



***"QUALITY MACHINE
TIRE SHOP TESTED"***

FEATURES

- Air Tank in Tower
- Dual Clamping Cylinders
- Semi-Automatic Swing Arm
- Inflater Jets on Each Clamp
- Inserts Protect Aluminum Wheels
- Dual Acting Bead Breaker
- Oiler & Water Separator Protected
- Totally Enclosed 1HP Motor

TECHNICAL DATA

- Inside Clamping 12" - 22"
- Outside Clamping 10" - 20"
- 24" With Optional Adaptors
- Maximum Tire Outside 39"
- Maximum Rim Width 13"
- Bead Breaker Force 5500lbs
- Power Requirement 115 volt
- One Year Parts & Onsite Labor



SM915TI PASSENGER & LT. TRUCK TIRE CHANGERS



FEATURES

- Air Tank in Tower
- Dual Clamping Cylinders
- Semi-Automatic Swing Arm
- Inflator Jets on Each Clamp
- Inserts Protect Aluminum Wheels
- Adjustable Bead Breaker
- Low Profile Mounting Helper (JUMBO)
- Bead Suppressing Tool (JUMBO)

TECHNICAL DATA

- Inside Clamping 13-24" (MAXI); 14-26" (JUMBO)
- Outside Clamping 12" - 22" (MAXI) 12"-24" (JUMBO)
- 26" Outside w/ optional clamps (MAXI) 28" (JUMBO)
- Maximum Tire Outside 47"
- 5500 lbs of Bead Breaker Force
- Maximum Rim Width 15"
- Power Requirements 115 volt

STANDARD ON JUMBO



#9208633 BEAD SUPPRESSOR

CEMB USA

SM915TI "JUMBO" TIRE MACHINE



FEATURES

- AIR TANK IN TOWER
- INFLATOR JETS ON EACH CLAMP
- INSIDE CHUCKING 14-26"
- OUTSIDE CHUCKING 12-24"
- 28" WITH OPTIONAL CLAMPS
- DUAL CLAMPING CYLINDERS
- RUN FLAT & LOW PROFILE MOUNTING HELPER
- ADJUSTABLE BEAD BREAKER SHOE

TECHNICAL DATA

- POWER REQUIREMENTS 115 VOLT
- MAXIMUM TIRE OUTSIDE 47"
- MAXIMUM RIM WIDTH 15"
- 5500 LBS OF BEAD BREAKER FORCE

STANDARD ACCESSORY

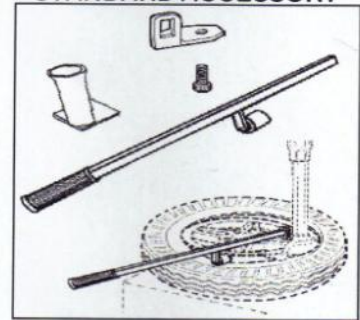

MANUAL BEAD SUPPRESSOR

OPTIONAL TCL-80 WHEEL & TIRE LIFT



OPTIONAL 4" EXTENSION CLAMPS

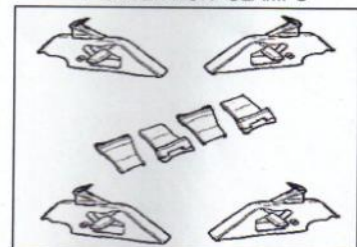

OPTIONAL ATV/MOTORCYCLE CLAMPS

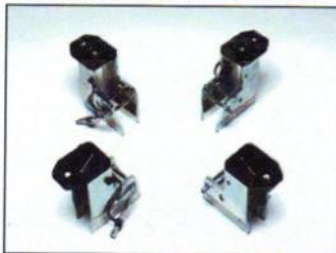

OPTIONAL QUICK CHANGE UNION KIT

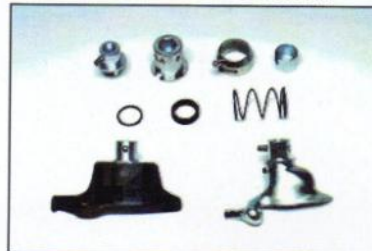



SM935TI TILT BACK TIRE CHANGER



FEATURES

- Dual Clamping Cylinders
- Tilt Tower For Greater Rigidity
- Inflator Jets On Each Clamp
- Inserts Protect Aluminum Wheels
- New Extended Bead Breaker
- Dual Action Bead Breaker Piston
- "TWO" Low Profile Mounting Helpers



TECHNICAL SPECIFICATIONS

- Inside Clamping 14-24"
- Outside Clamping 12-22"
- 26" With Optional Adaptors
- Maximum Tire Outside 39"
- Maximum Rim Width 15"
- Bead Breaker Force 5500 LBS
- Power Requirements 115 Volt

OPTIONAL ACCESSORIES

FOUR INCH EXTENSION JAWS

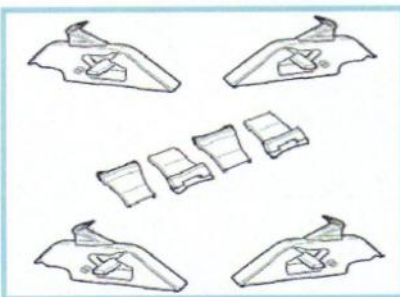

WHEEL LIFT

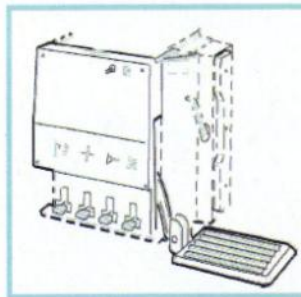

QUICK UNION KIT

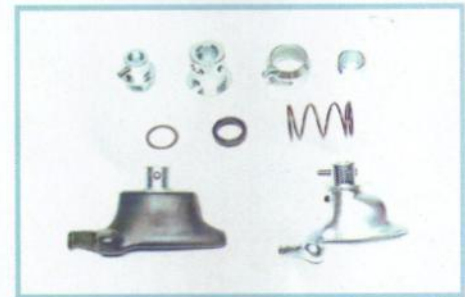



TRUCK TIRE CHANGERS

UNIVERSAL TIRE CHANGER
FOR TRUCK & BUS WHEELS 13"- 27"

CM-27T

FEATURES

- Mobile cable control unit
- Two speed hydraulic pump motor
- Bi-directional rotation
- Self centering universal wheel chuck
- Rim pliers and rim lever standard
- Optional (alloy wheel protectors)
- Optional tubeless roller

TECHNICAL SPECS

- Maximum wheel weight 3300 lbs
- Maximum wheel width 31"
- Maximum wheel diameter 63"
- Power requirement 230 volt 1-phase
- Gross weight 1346 lbs



UNIVERSAL TIRE CHANGER
FOR TRUCK, BUS, AGRICULTURE AND
EARTH MOVING VEHICLES 14" - 56"

SM-56T

FEATURES

- Mobile cable control unit
- Two speed hydraulic pump motor
- Bi-directional rotation
- Self centering universal wheel chuck
- Rim pliers and rim lever standard
- Optional (alloy wheel protectors)
- Optional tubeless roller

TECHNICAL SPECS

- Maximum wheel weight 3300 lbs
- Maximum wheel width 42"
- Maximum wheel diameter 90.5 "
- Power requirements 230 volt 3-phase
- Gross weight 1795 lbs
- 56" adaptors included





K-8 COMPUTERIZED WHEEL BALANCER



FEATURES

- Self Calibrating and Self Diagnostics
- Manual data entry
- SPLIT weight program
- Optimization program for tire & rim unbalance
- Aluminum program for alloy rims
- Static program
- Menu program for rapid selection of options
- Standard quick nut with 40mm shaft

TECHNICAL DATA

- Standard power supply 115Volt
- Balancing accuracy to 1 gram
- Rim width 1.5" - 20"
- Rim diameter 10"-30"
- Maximum wheel weight 165lbs

CEMB USA



Cemb USA (BL-Systems Inc)
 5012 Bristol Industrial Way Buford, Ga. 30518
 Phone 877-259-4335 Fax 770-271-8917
 E-mail sales@bl-systems.com Web www.cemb-usa.com

"COMPARE THESE FEATURES"

- Automatic Distance Diameter Entry
- Automatic Direct Stick-On Weight Locator
- One Button Split And Hidden Weight Program
- One Button Ounce And Gram Selector
- Quality "Italian Built" By CEMB

K-9 Wheel Balancer

"Take a bite out of the competitor with the K-9"

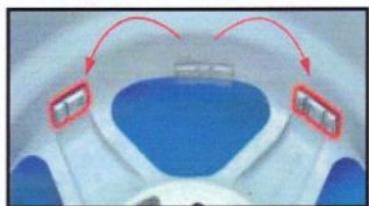

SPLIT & HIDDEN WEIGHT PROGRAM

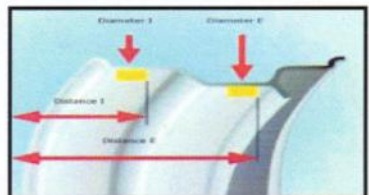

STICK-ON WEIGHT LOCATION PROGRAM



OTHER FEATURES

- Self Calibrating and Self Diagnostics
- Optimization program for tire & rim unbalance
- Aluminum program for alloy rims
- Static program
- Menu program for rapid selection of options
- Standard quick nut with 40mm shaft

TECHNICAL DATA

- Standard power supply 115Volt
- Balancing accuracy to 1 gram
- Rim width 1.5" - 20"
- Rim diameter 10"-30"
- Maximum wheel weight 165lbs



BG 1/21/08

Specifications subject to change without notice



C-71EVO COMPUTERIZED WHEEL BALANCER

With the new and exclusive VDD measuring (Virtual Direct Drive) a CEMB patent, which obtains reliable unbalance measurements in nearly half the cycle time of other balancers in this range

UNIQUE FEATURES

- One button split & hidden weight program
- One button ounce and gram selectable
- Self-diagnosis and self-calibrating
- Optimization program for reducing the amount of weight used
- Automatic input of distance and diameter
- Foot brake when placing weights
- Splash guard hood standard
- Automatic direct weight location program (no repositioning of stick-on weights)
- Direct drive, no belts or pulleys
- Almost twice as fast as other balancers
- User friendly multi-color display
- Fully automatic braking
- Lift shown optional

TECHNICAL DATA

- Power requirements 115V
- Rim width 1.5-20"
- Rim diameter 10-30"
- Maximum wheel weight 165 lbs
- Balancing accuracy to 1 gram
- Reads grams or ounces
- Comes standard with 40MM shaft



incredible speed

AUTOMATICALLY DETECTS ALUMINUM WHEELS

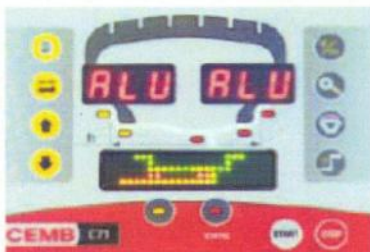

SPLITS WEIGHT WITH THE PUSH OF ONE BUTTON



PLACES STICK-ON WEIGHT ELECTRONICALLY

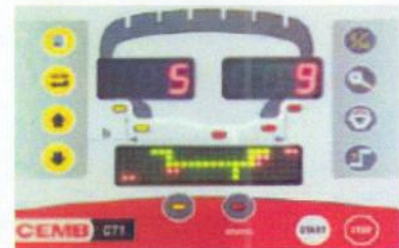



C-73L VIDEO WHEEL BALANCER

FEATURES

- HD high definition 15" LCD flat screen video monitor
- 3D Automatic input of distance, diameter and width (optional)
- Optimization program for ride quality and weight reduction
- "Intelligent" averaging system for residual static in-balance
- No need for a roller to get radial run-out
- Reads radial run-out on every spin (optional)
- Automatic start and automatic braking
- Alum "S" program for alloy wheels
- Direct placement program for stick-on weights
- One button split and hidden weight program
- Four operator function
- Self-diagnostic and self-calibrating
- Space saving hood
- Options available:
Pneumatic chucking
Width and radial run-out sonar,
Wheel lift, truck cone sets
Lug hole adaptor plates
Motorcycle adaptor sets



Optional Wheel Lift (pneumatic)

TECHNICAL DATA

- Maximum wheel weight----- 165 lbs
- Standard power supply-----115 volt
- Balancing accuracy-----. 5 gr.
- Rim width-----1.5" – 20"
- Rim Diameter -----10" – 30"
- Maximum tire diameter-----42"
- Cycle time -----6 sec.

One Button Split & Hidden Weight Program



Automatic Direct Weight Placement Program

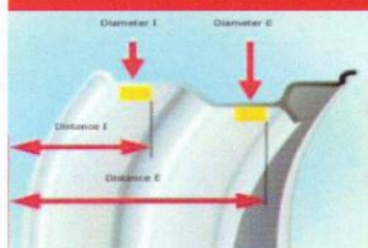

Optional : Radial run-out reading on every spin

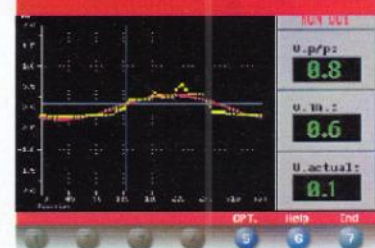



TRUCK AND BUS WHEEL BALANCER

Automatic 3D Video wheel balancer for heavy commercial vehicles and car wheels. This off-the-vehicle wheel balancers allows you to balance all the wheels dynamically, rear wheels included with extreme accuracy. This can increase up to 20% of your tire life. This balancer comes standard with accessories that can handle 98% of everything on the highway with four or more wheels and with the optional motorcycle adaptors can handle motorcycle and ATV's as well. We guarantee extreme accuracy even for motorcycle and car wheels.



FEATURES

- Eccentricity (run-out) capable
- TFT 17" flat screen monitor
- Multiple languages
- Integrally mounted pneumatic lift
- "Soft action type" lift / pedal operated
- Fully automatic cycle with braking
- Electro-pneumatic stationary brake
- Automatic input of distance and diameter
- Automatic detection of alloy rims
- Shows static and dynamic unbalance
- Comes with car & lt. truck wheel adaptors
- Split & hidden weight program for spoke wheels
- Optimization program to compensate the tire unbalance with the rim unbalance
- Self diagnosis and self calibrating

TECHNICAL SPECS

- Power supply 115 Volt
- Balancing speed <70 RPM (truck) <100 RPM (car)
- Balancing accuracy 10g truck; 1g car
- Cycle time 8—20 seconds
- Wheel diameter 10"—30"; Rim width 1.5"—20"
- Maximum wheel diameter 51"
- Maximum wheel weight 550 lbs
- Gross weight 554 lbs

C-218 is supplied with a pedal operated powerful built-in pneumatic lift with a moveable trolley for operator safety and wheel placement. Also this lift is a "soft action" type lift for minimum operator force to center and lock the wheels.

Optional: Eccentricity (run-out) sonar for detecting total wheel run-out in order to compensate before mounting especially on front axle wheels. This can reduce tire wear as well as ride related problems caused by tire hopping on out of round wheel assemblies.

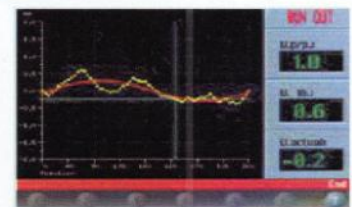
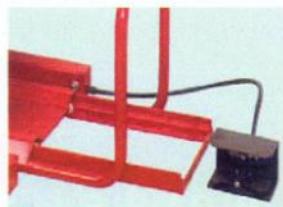



DWA 1000R

8 CAMERA CCD SENSOR WHEEL ALIGNMENT MACHINE FOR CARS AND LIGHT TRUCKS

STANDARD HARDWARE AND SOFTWARE FEATURES

- Blue tooth wireless alignment heads
- Lithium ion batteries
- Connecting cables also included
- Shock resistance heads (no moving parts)
- Accelerometers (newest measuring technology)
- Linux based trouble free software
- Standard 19" monitor, keyboard and printer
- 24" wheel clamping range (30" optional) does not mean rim diameter
- Complete vehicle and customer data base
- Alignment specification 30 years
- Two front turntables
- Steering wheel and brake pedal lock
- Multiple languages

PROCEDURE FEATURES

- User friendly guided program
- Function controls at measuring heads
- Two wheel alignment capable with 2 heads only
- Run-out compensation lifted or rolled 90° or 180°
- Measures SAI, toe out on turns and set-back
- Lock and hold adjustments for lifted wheels
- View all adjustments of one axle on one screen
- Measures under spoilers without extensions

OPTIONAL ACCESSORIES

- 30 " rim extension kit
- Drop down kit for tires over 40" in diameter
- Jaw extension kit for dual wheel trucks
- Wheel grabber kit



Standard wheel clamps



Shock resistant "Blue Tooth" Measuring Heads

Fast caster sweep selectable



Live front axle alignment readings



Lifted or rolling run-out selectable





**DWA 1000R
LIGHT**

8 CAMERA CCD SENSOR WHEEL ALIGNMENT SYSTEM FOR CARS AND LIGHT TRUCKS

STANDARD HARDWARE AND SOFTWARE FEATURES

- Four blue tooth wireless rechargeable alignment heads
- Lithium ion batteries for long life
- Connecting cables included for continual operation
- Accelerometers (newest measuring technology)
- PC based software with multiple languages
- 24" wheel clamping range (30" optional) does not mean rim diameter
- Power supply and USB Bluetooth antenna
- Complete vehicle and customer data base
- Alignment specification 30 years
- Steering wheel and brake pedal lock
- 8 cameras allows blocked beams and calibration check during every alignment
- User friendly software guides technician through each alignment

PROCEDURE FEATURE

- Function controls at measuring heads
- Two wheel alignment capable with 2 heads only
- Run-out compensation lifted or rolled 90° or 180°
- Measures SAI, toe out on turns and set-back
- Lock and hold adjustments for lifted wheels
- View all adjustments of one axle on one screen
- Front and rear spoiler mode allows heads to be tilted into view
- Zoom screen from each head to increase viewing range
- All front and rear readings are live

OPTIONAL ACCESSORIES

- 30" rim extension kit
- Drop down kit for tires over 40" in diameter
- Jaw extension kit for dual wheel trucks
- Wheel grabber kit

Four "Shock Resistant" Blue Tooth Rechargeable Alignment Heads



Brake Pedal And Steering Wheel Lock

Four Standard Wheel Clamps



Storage Rack With Power Supply And Blue Tooth Antenna



NOTE

Minimum Requirements Of The Computer (not supplied by Cemb)
Windows XP-SP2 or Vista;
Ram 512M; 1-GHz Processor;
Two Open USB Ports

Fast caster sweep selectable



Live Front axle alignment readings



Lifted or rolling run-out selectable



Chem Nut Equipment

7 County Street
Lakeville, MA 02347

Phone: 508-946-3479
Mobile: 508-208-6170