



*Rediframe® Fixed*  
*Rediflex® Adjustable*  
*Kerfed Frames*  
*Sidelites*  
*Borrowed Lites*  
*Specialty Frames*



PREFINISHED STEEL DOOR FRAMES





# The ORIGINAL Prefinished, Fire-Rated Steel Door Frame

Rediframe® has dedicated itself to quality workmanship and long-term customer satisfaction by producing the finest prefinished steel door frames. Rediframe's unique, strong-as-the-wall design is available in fixed (Rediframe®) and adjustable (Rediflex®) designs.

## Installation

The success of Rediframe® lies in the ease of installation, saving time and money. **Rediframe® is pre-finished, so installation occurs AFTER the wall is finished. Rediframe's Certified Installers Program develops trained, experienced installers to assure a worry-free project.**

## Innovation

Rediframe's continuing innovation has produced an adjustable strike, a patented casing corner bracket to hold miters tight and true, and the Universal Hinge Prep, S56 safety guard emboss, 4-1/2" extra heavy hinge prep (.180), and an ABH 1000 / GJ100 series concealed overhead holder and stop.

## Security\*

**Rediframe® is designed to sleeve the wall, becoming an integral part of the wall system.** In comparative impact testing 18 ga. Rediframe® withstood 850 impacts, over 500 more than hollow metal. The difference is the anchoring system. Not only does Rediframe® sleeve the wall, but it anchors to the wall using at least 30 fasteners. Hollow metal anchors to the wall from the frame throat using only 8 anchors that hold the frame away from the inherent strength of the wall.

## Durability\*

Rediframe® carries a **Certification of Level A 1,000,000 cycles (ANSI 250.5-1994).**

## Testing

Rediframe® pledges to stay ahead of the field when it comes to fire ratings. We have taken the initiative to pass the most stringent and difficult tests to acquire the Warnock Hersey standard in **both neutral (UL 10B) and positive (UL 10C) pressure fire ratings.**

## Delivery

Rediframe® delivers a 3-week lead time for standard or custom colors (custom colors after approval of paint chip). The best customer service in the industry.

\*Test results available upon request.



## Rediframe® Fixed Frame 16, 18 (standard) and 20 Gauge Steel

Rediframe® is a prefinished fixed throat steel door frame designed for interior and exterior applications where the strength of a steel door frame is desired. Especially suited for new construction and light commercial applications: hotel/motel, assisted living, or residential.

- 1-3/8" and 1-3/4" doors
- 17 Standard wall sizes
- Over 70 custom profiles available, from 2-5/8" to 15"
- 5/8" stop height
- Demountable without damage to the finished wall, door or frame
- Standard frame is cold-rolled steel per ASTM A1008M-16
- Standard casing is 22-gauge cold-rolled steel per ASTM A1008M-16.
- 3-1/2", 4" and 4-1/2" hinge preps
- 2-3/4" T-strike prep
- Embossed 90 minute neutral and positive pressure fire label; wood or steel stud.

### Options

- S56 Steel Colonial casing, aluminum casing, or wood casing prep.
- Galvanized Standard Casing (A-40)
- Galvanized Frame (A-40)
- Cased opening, Dutch, single swing, communicating and pair doors, pocket, borrowed lites, transom and sidelites.
- Special hinge or strike location
- Non-standard wall size
- Universal Hinge Prep (no charge)
- 4-7/8" Adjustable ASA strike prep (no charge)
- 2-3/4" Deadbolt strike (1-3/4" doors)
- 2-1/4" Full lip strike (1-3/4" doors)



## Kerf Rediframe® Fixed Frame for Weatherstripping 16, 18 (standard) and 20 Gauge Steel

Kerf profile option for Rediframe® is a fixed throat steel door frame designed for interior and exterior applications where the strength of a steel door frame is desired. Especially suited for new construction and light commercial applications: hotel/motel, assisted living, or residential.

- 1-3/4" doors only
- 12 Standard wall sizes
- Over 60 custom profiles available, ranging from 4" to 15"
- 5/8" stop height
- Demountable without damage to the finished wall, door or frame
- Standard frame is cold-rolled steel per ASTM A1008M-16
- Standard casing is 22-gauge cold-rolled steel per ASTM A1008M-16.
- 4" and 4-1/2" hinge preps
- 2-3/4" T-strike prep
- Embossed 90 minute neutral and positive pressure fire label; wood or steel stud.

### Options

- S56 Steel Colonial casing, aluminum casing, or wood casing prep.
- Galvanized Standard Casing (A-40)
- Galvanized Frame (A-40)
- Special hinge or strike location
- Non-standard wall size
- Universal Hinge Prep (no charge)
- 4-7/8" adjustable ASA strike prep (no charge)
- 2-3/4" Deadbolt strike (1-3/4" doors)
- 2-1/4" Full lip strike (1-3/4" doors)



301 MISSION STREET  
SAN FRANCISCO, CALIFORNIA  
SINGLE RABBET FRAMES WITH  
ROLLER LATCH PREP

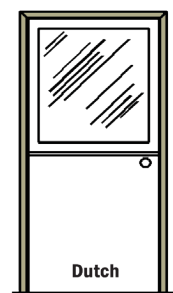
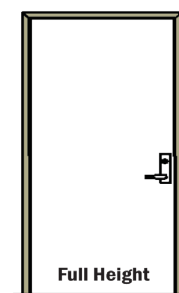
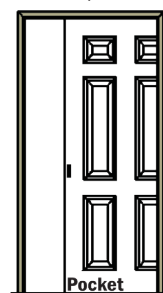
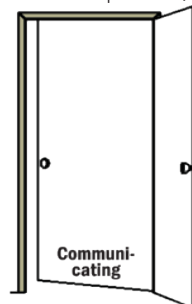





## Rediflex® Adjustable 16, 18 (standard) and 20 Gauge Steel\*

Rediflex® is an adjustable throat steel door frame designed for interior and exterior applications where varying wall sizes must be accommodated and for prehanging. Residential or light commercial, new or remodeling construction.

- 1-3/4", 1-3/8" doors
- 4" to 12-1/4" wall sizes (1-1/4" adjustment)
- 5/8" stop height
- Single and pair doors
- Demountable without damage to the finished wall, door or frame
- Standard frame is cold-rolled steel per ASTM A1008M-16
- Standard casing is 22-gauge cold-rolled steel per ASTM A1008M-16
- 4" and 4-1/2" hinge preps (1-3/4" doors only)
- 2-3/4" T-strike prep (1-3/4", 1-3/8")
- Embossed 90 minute neutral and positive pressure fire label; wood or steel stud.

### Options

- S56 Steel Colonial casing, aluminum casing, or wood casing prep.
- Galvanized Standard Casing (A-40)
- Galvanized Frame (A-40)
- Special hinge or strike location
- Dutch Door
- Universal Hinge Prep (no charge)
- 4-7/8" adjustable ASA strike prep (no charge, (1-3/4" doors only))
- 2-3/4" Deadbolt strike (1-3/4" doors only)
- 2-1/4" Full lip strike (1-3/4" doors only)

\*Base side: 18 or 20 gauge  
Closure side: 18 or 22 gauge

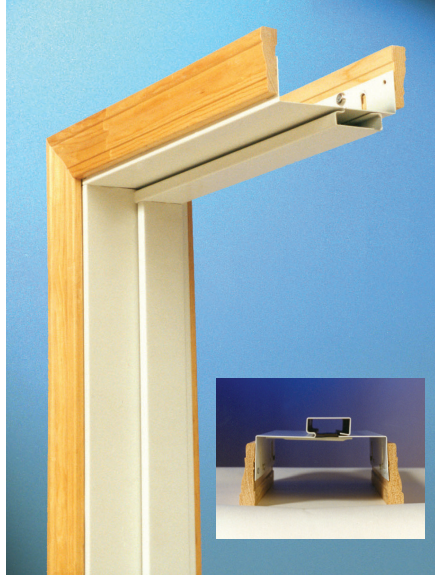

## Kerf Rediflex® Adjustable for Weatherstripping 16, 18 (standard) and 20 Gauge Steel\*

Kerf profile option for Rediflex® is an adjustable throat steel door frame designed for prehang applications. Residential or light commercial, new or remodeling construction.

- 1-3/4" doors
- 4" to 12-1/2" wall sizes (1" adjustment)
- 5/8" stop height
- Demountable without damage to the finished wall, door or frame
- Standard frame is cold-rolled steel per ASTM A1008M-16x
- Prepped with anchoring holes with vision slot for wood casing.
- 4" and 4-1/2" hinge preps
- 2-3/4" T-strike prep
- Embossed 90 minute neutral and positive pressure fire label; wood or steel stud.

### Options

- S56 Steel Colonial casing, aluminum casing, or steel casing prep optional.
- Galvanized Standard Casing (A-40)
- Galvanized Frame (A-40)
- Special hinge or strike location
- Accommodates non-standard wall size
- Universal Hinge Prep (no charge)
- 4-7/8" adjustable ASA strike prep (no charge)
- 2-3/4" Deadbolt strike
- 2-1/4" Full lip strike (1-3/4" doors)
- Threshold prep

\*Base side: 18 or 20 gauge  
Closure side: 18 or 22 gauge

Rediframe steel frames have been chosen to outfit hospitality, multi-family, condominiums, office buildings, and assisted living facilities. Our diversity is in our design. Rediframe is engineered to adapt to a variety of commercial and residential applications. Sidelites, Borrowed Lites, Pocket Doors, Communicating Doors ... try Rediframe first for special openings.

Rediframe is prefinished and can be specified to fit the hardware for any job. And, because it is prefinished, it installs over finished walls, creating a perfect jobsite finish.



ANNAPOLIS AREA CHRISTIAN SCHOOL  
SEVERN, MD



HOTEL PARK CENTRAL  
ALBUQUERQUE, NEW MEXICO



PASEO CONDOMINIUMS  
FORT MYERS, FLORIDA



MARRIOTT GRAND CHATEAU  
LAS VEGAS, NEVADA

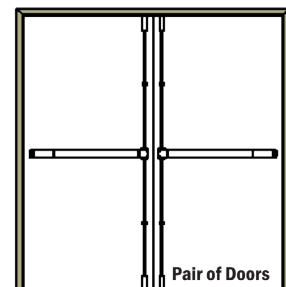
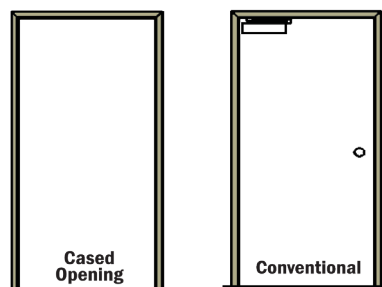



## Casing



**Steel**  
 Prefinished steel designed for ease of installation. Standard on all Rediframe products except Kerf Rediflex. (1-1/2" width)

**Aluminum**  
 Modern, sculptured lines in durable prefinished aluminum. Available in same color finishes as steel. (1-1/2" width)

**S56 Steel Colonial**  
 Specially designed corner clips align S56 to standard Rediframe casing clips. Available in same color finishes as steel. (2-1/4" width)

**S56 Rosette**  
 Elegant Rosette gives S56 Steel Colonial casing a polished, formal look. Available in same color finishes as steel. (2-1/4" width)

**Wood**  
 Finish Rediframe with decorative wood casing (supplied by others). Paint, stain ... whatever fits the decor (profile and width varies).

## Sidelites and Borrowed Lites

Rediframe is engineered to adapt to an array of design considerations, limited only by the imagination. Rediframe is easily reconfigured to produce custom borrowed lites and sidelites to specifications. Like all Rediframe products, these borrowed lites and sidelites are prefinished and designed to be installed after the walls are finished. Sidelites are fire-rated up to 45 minutes; borrowed lites are rated up to 60 minutes (See fire ratings page 6).

- Sidelite (single/double)
- Sidelite with mullion(s)
- Partial Sidelite
- Borrowed Lite
- Borrowed Lite with mullion(s)
- Transom
- Panel Over

Rediframe's Engineers can create a custom sidelite or borrowed lite application for your project.

### Sidelite and Borrowed Lite Options

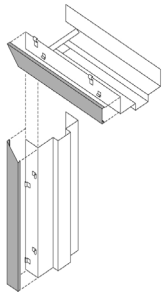

CORNER DETAIL

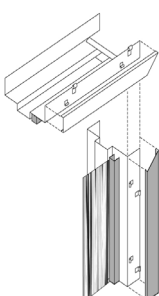

CORNER DETAIL WITH GLASS STOP

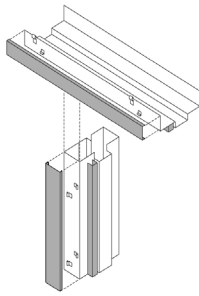

HEAD / MULLION DETAIL

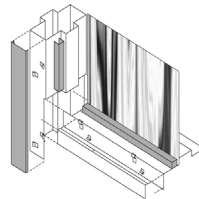

SILL / MULLION DETAIL WITH GLASS STOP

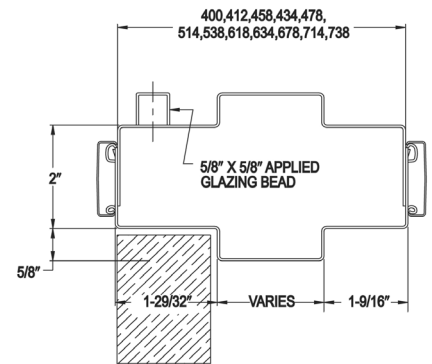



# Rediframe®

**REDIFRAME® INSTALLATION**  
 Sleeve header and upright over wall sections in opening. Pull header firmly down so that side jambs rest on floor. Install door, close; use as template to square frame.

**Apply fasteners** starting in middle of header and upper end of hinge jamb. Apply one fastener per lance.

**Apply steel, aluminum or S56 Colonial steel casing** by rolling over casing lance and snapping over bottom of clip.

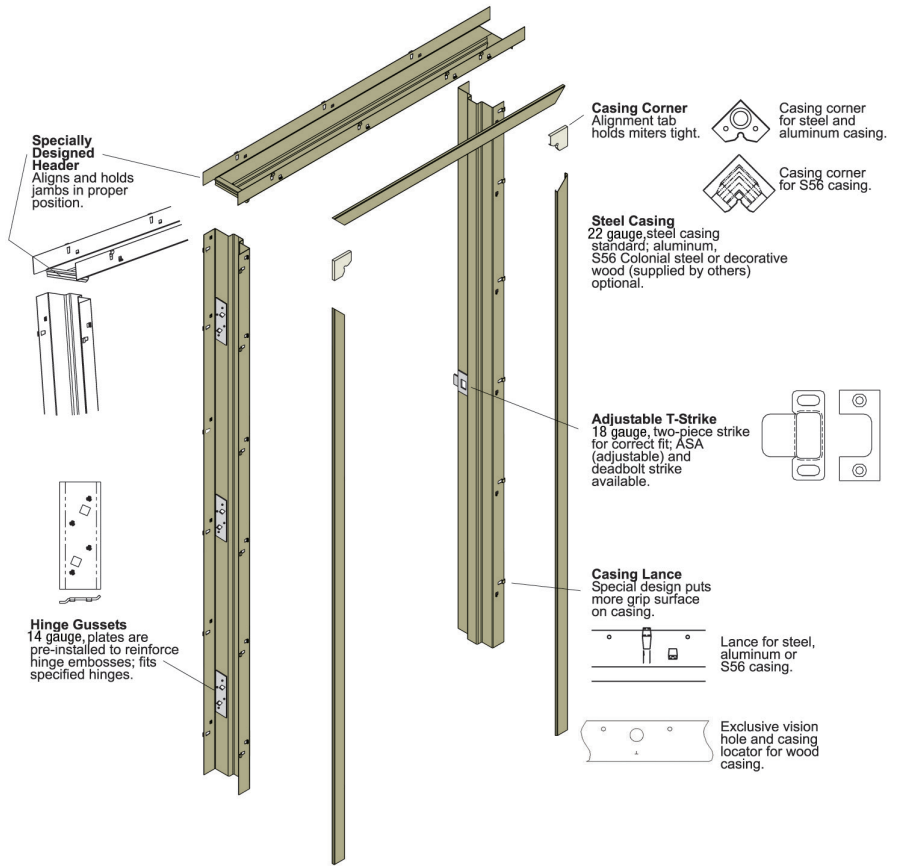

# Rediflex® Adjustable

**REDIFLEX® INSTALLATION**  
 Assemble base unit consisting of base header and uprights, threshold, and door. Rotate base unit into the opening.

**Install frame closure pieces** after setting clearances. Attach to wall using recommended fasteners.

**Apply wood casing** using the vision slots on the frame. Standard Steel, aluminum or S56 steel is applied same as Rediframe® with appropriate clip system.

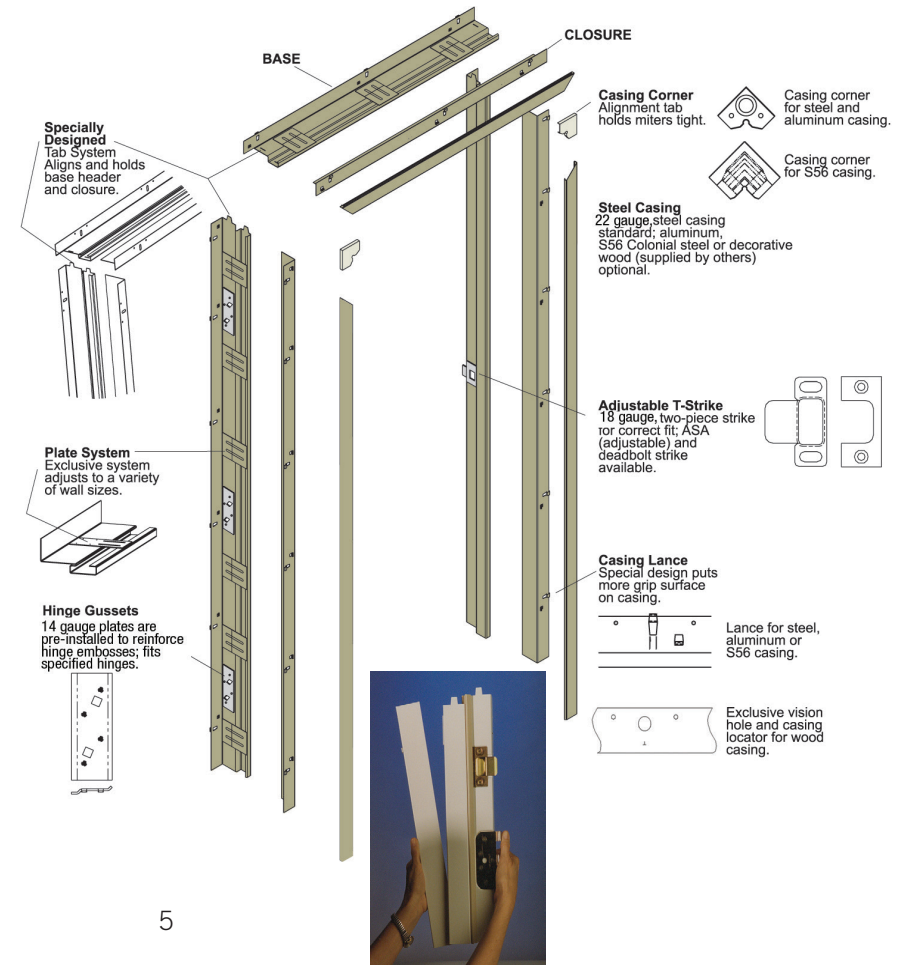



## Rough Openings

Measure rough opening for door frames and sidelites from finished floor. Frames may be conveniently installed after walls are finished and flooring application is laid.

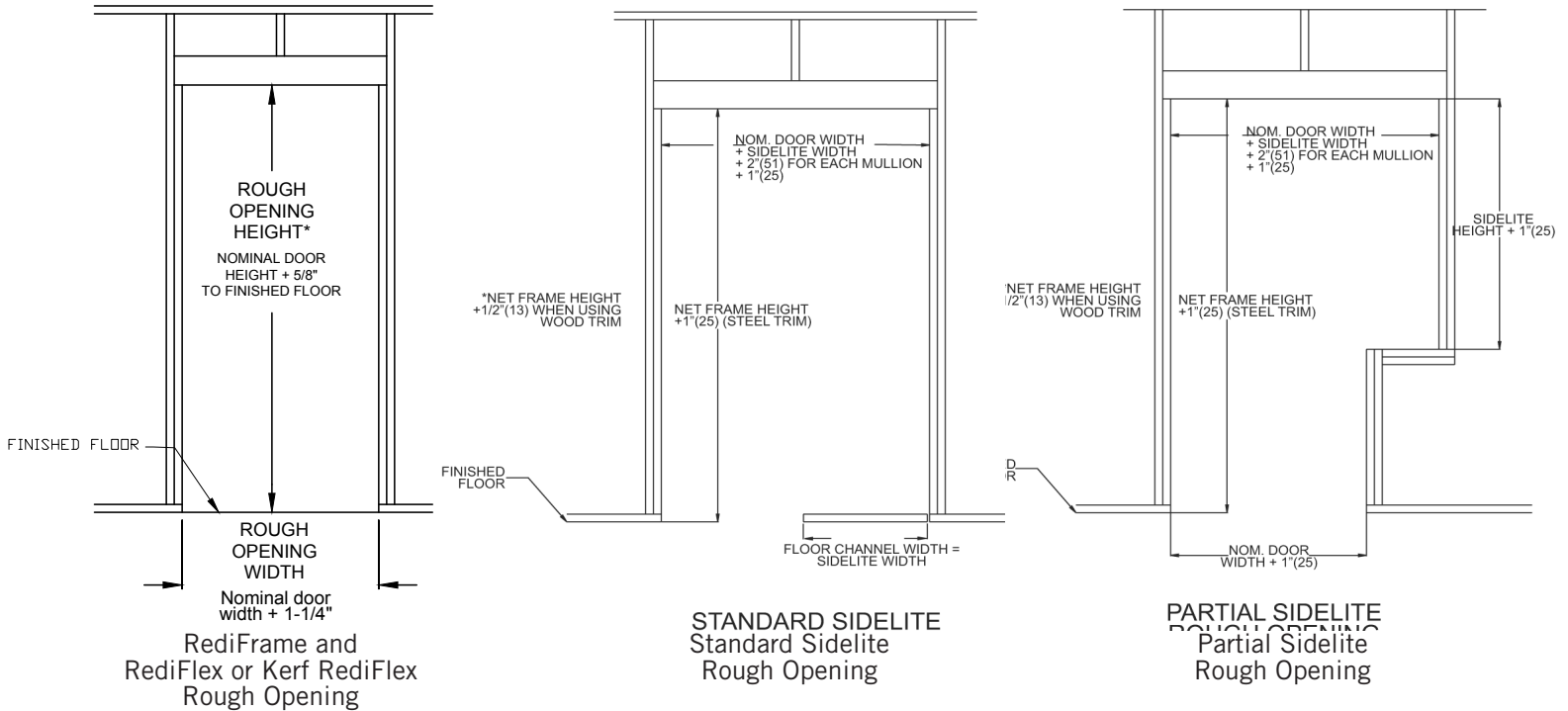

## Fire Ratings

UL 10B (NEUTRAL) and UL10C (POSITIVE) FIRE RATINGS

REDIFRAME® / KERF REDIFRAME® PREFINISHED DOOR FRAMES

\*SINGLE AND PAIR DOOR FRAMES (1-3/4" DOOR)

Rating	Maximum Opening Size	*Minimum Wall Size	Maximum Wall Size	Frame Gauge	Test Standard	Edge Seals
90 min.	4'0" x 9'0"	3-1/2"	15"	18 or 20	Neutral	Not Required
90 min.	8'0" x 9'0"	3-1/2"	15"	18 or 20	Neutral	Not Required
90 min.	4'0" x 9'0"	3-1/2"	15"	18 or 20	Positive***	*Listed Cat. A Doors: No additional edge seals required.
90 min.	8'0" x 9'0"	3-1/2"	15"	18 or 20	Positive***	*Listed Cat. B Doors: Additional Category G edge seals required.

\*4" Minimum Wall for Kerf Rediframe

"S" Smoke and Draft label; applicable only if listed Category H Smoke and Draft Control Gasket is applied.

SIDELITE / TRANSOM ASSEMBLY FRAMES (1-3/4" DOORS) MAXIMUM ASSEMBLY SIZE — 10' Width x 10' Height

Rating	Minimum Wall Size	Maximum Wall Size	Maximum Glass Width+	Maximum Glass Height+	Frame Gauge	Glass Type	Test Standard	Maximum Door Size	Glazing Material	Max. Assembly Size
45 min.	3-1/2"	13'	24"	106"	18 or 20	Wire	Neutral	3'0" x 9'0"	Not Required	10'0" x 10'0"
45 min.	3-1/2"	13'	36"	36"	18 or 20	Wire	Neutral	3'0" x 9'0"	Not Required	10'0" x 10'0"
45 min.	3-1/2"	13'	36"	94"	18 or 20	Ceramic	Neutral	3'0" x 9'0"	Listed	10'0" x 10'0"
45 min.	3-1/2"	13'	24"	106"	18 or 20	Wire	Positive***	3'0" x 9'0"	Listed	10'0" x 10'0"
45 min.	3-1/2"	13'	36"	94"	18 or 20	Ceramic	Positive***	3'0" x 9'0"	Listed	10'0" x 10'0"

+ Visible glass equals glass size - 2 X stop height (5/8") Example: 36" Glass Width = 34-3/4" Visible Glass

FIRE WINDOW FRAMES

Rating	Minimum Wall Size	Maximum Wall Size	Maximum Glass Width+	Maximum Glass Height+	Frame Gauge	Glass Type	Test Standard	Glazing Material	Max. Assembly Size
45 min.	3-1/2"	13'	24"	106"	18 or 20	Wire	Neutral	Not Required	10'0" x 10'0"
45 min.	3-1/2"	13'	36"	36"	18 or 20	Wire	Neutral	Not Required	10'0" x 10'0"
60 min.	3-1/2"	13'	36"	36"	18 or 20	Wire	Neutral	Listed	9'4" x 3'0"
45 min.	3-1/2"	13'	24"	106"	18 or 20	Wire	Positive***	Listed	10'0" x 10'0"
45 min.	3-1/2"	13'	36"	94"	18 or 20	Ceramic	Positive***	Listed	10'0" x 10'0"

+ Visible glass equals glass size - 2 X stop height (5/8") Example: 36" Glass Width = 34-3/4" Visible Glass

REDIFLEX® ADJUSTABLE FRAMES

Rating	Minimum Wall Size	Maximum Wall Size Kerf	Maximum Base Wall Size Non-Kerf	Closure Wall Size	Maximum Gauge	Test Gauge	Gauge	Frame Size	Standard	Edge Seals
90 min.	4"	12-1/2"	12-1/4"	18 or 20	22 or 18	3'6" x 7'1"	Neutral	Not Required		
90 min.	4"	12-1/2"	12-1/4"	18	22 or 18	3'0" x 8'0"	Neutral	Not Required		
90 min.	4"	12-1/2"	12-1/4"	18	22 or 18	6'0" x 7'0"	Neutral	Not Required		
60 min.**	4"	12-1/2"	12-1/4"	18	22 or 18	8'0" x 8'0"	Neutral	Not Required		
90 min.	4"	12-1/2"	12-1/4"	18 or 20	22 or 18	3'0" x 7'0"	Positive***	*Listed	Cat. A Doors: No add. edge seals reqd.	
90 min.	4"	12-1/2"	12-1/4"	18	22 or 18	3'0" x 8'0"	Positive***	*Listed	Cat. B Doors: Add. Category G edge seals reqd.	
90 min.	4"	12-1/2"	12-1/4"	18	22 or 18	6'0" x 7'0"	Positive***	*Listed		
60 min.**	4"	12-1/2"	12-1/4"	18	22 or 18	8'0" x 8'0"	Positive***	*Listed		

\*\*Reinforcing screws required

ALL RATINGS ARE SUITABLE FOR STEEL, ALUMINUM, S56 STEEL COLONIAL OR WOOD TRIM. \*\*\* Maximum 60 minutes with wood trim option





# Standard Hardware Locations

Contact factory for complete Standard Hardware Locations

## Hinge & Strike Locations for 4-1/2" hinges, 2-3/4" "T" Strike or 4-7/8" ASA Strike

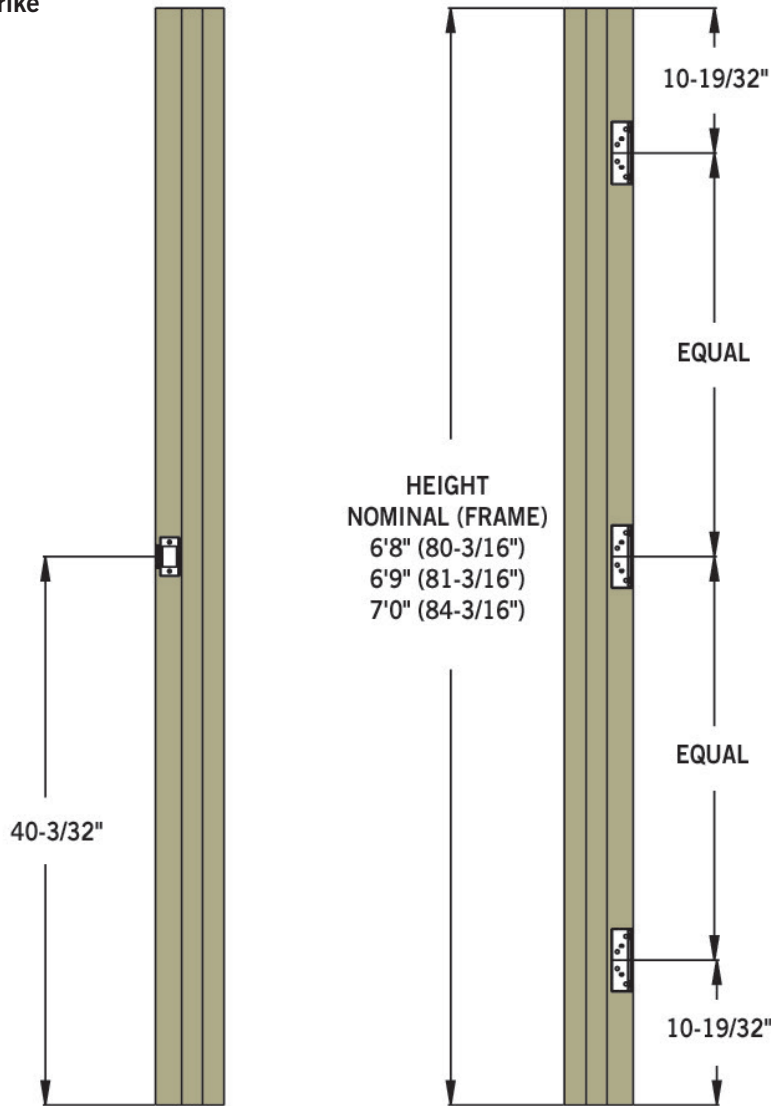

## Strike Preps



## Hinge Preps



## Special Preps

Special emboss for door guard application on S56 Colonial Casing. Provides a flat surface for hardware.

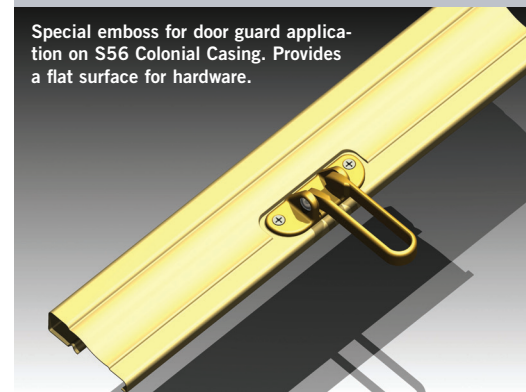

ABH 1000 / GJ100 series concealed overhead stop (Rediframe Only)

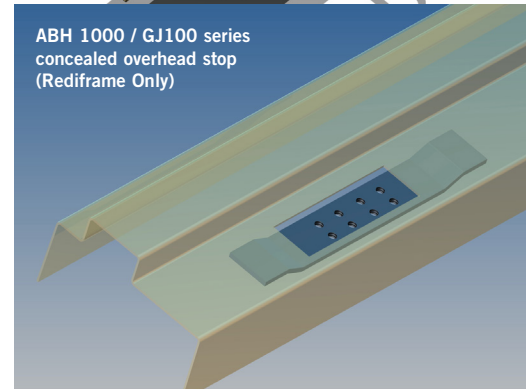

4-1/2" Heavy weight hinge prep (.180 thickness) (Rediframe Only)

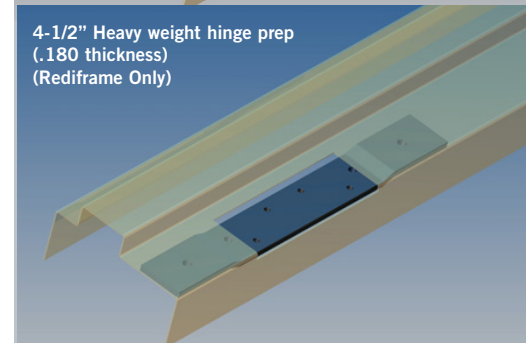

## Hinge Prep Specifications

Size	Type	Product			
		RF	Kerf RF	RFX	Kerf RFX
3-1/2"	1/4" Radius Corner (1-3/8" door)	■	—	■	—
3-1/2"	5/8" Radius Corner (1-3/8" door)	■*	—	■*	—
4"	1/4" Radius Corner	■	■	■	■
4"	5/8" Radius UHP°	■	■	■	■
4-1/2"	Square Corner (.134) Std. Weight	■	■	■	■
4-1/2"	Square Corner (.180) Heavy Weight	■**	■**	■**	■**
5"	Square Corner (.190) Heavy Weight	■**	■**	■**	■**

°UHP = Universal Hinge Prep; Adapts to Pease, Taylor, Therma Tru, Masonite, and standard template hinge patterns.

## Strike Prep Specifications

Size	Type	Product			
		RF	Kerf RF	RFX	Kerf RFX
1-1/4" x 2-3/4"	"T" Strike Emboss (1-3/8" door)	■	—	■	—
1-1/4" x 2-3/4"	"T" Strike Emboss (1-3/4" door)	■	■	■	■
1-1/4" x 4-7/8"	"ASA" Adjustable Strike Emboss (1-3/4" door)	■*	■*	■*	■*
1-1/8" x 2-3/4"	Deadbolt Strike Emboss (1-3/4" door)	■**	■**	■**	■**
1-1/2" x 2-1/4"	Full Lip Strike (1-3/4" doors only)	■*	■*	■*	■*

\* = Option / NC      \*\* = Option / Upcharge



# Finishes

Prefinished Rediframe® is available in eight standard colors. "Custom color" selections can be matched to ensure the finished product will meet specifications. Custom colors will ship three weeks after final approval.

Rediframe® is finished in a state-of-the-art paint assembly line with electrostatically-applied, baked-on enamel. Paint finish meets or exceeds 200 hour salt spray test per ASTM-B117-97. Painted finishes also finished 700 hour humidity test per ASTM-D1735-87.

Rediframe® is available in cold rolled steel or galvanized zinc coating.

## Standard Color Selections

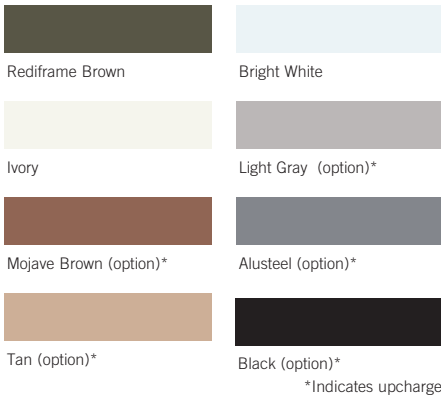

## Prime Colors



Prime Gray

## Custom Colors

Rediframe® can match your custom color to your specifications! Contact factory for lead times and pricing.

# Warranty

The Warranty for REDIFRAME® STEEL FRAMES manufactured by DUNBARTON DOOR AND ENTRY SYSTEMS is to the original consumer purchaser to be free from defects in material and workmanship for a period of one (1) year from the date of purchase.

REDIFRAME® products manufactured with galvanized steel are warranted against rusting for a period of one (1) year from the date of purchase, provided the finish has not been cut or abraded through the metal. Galvanized steel should be used for exterior applications and where air has a high salt content or in locations with high humidity; see specifications.

This warranty is applicable only when the product(s) covered by it have been installed in accordance with the recommended written installation instructions of REDIFRAME® and with established building practices, have been accorded treatment which is considered good practice in the building industry regarding storage and maintenance, and have been subject only to normal use. Because REDIFRAME® cannot control the manner in which its products are handled after leaving its premises, this warranty does not apply to the finish or accessories of any product.

ANY AND ALL IMPLIED WARRANTIES HERETO ARE LIMITED TO ONE (1) YEAR FROM THE DATE OF PURCHASE.

Some states do not allow limitations on how long an implied warranty lasts, so the above limitations may not apply to you. In the event the original consumer purchaser of any REDIFRAME® product believes that the frame or any parts thereof covered by this warranty are defective, a letter outlining the alleged defect should be sent postage prepaid to the following address:  
DUNBARTON DOOR AND ENTRY SYSTEMS  
P.O. Box 8577

Dothan, Alabama 36304-0577

Any REDIFRAME® product, or any parts thereof covered by this warranty which, upon inspection by an authorized representative of DUNBARTON, are found by said representative to be defective will be repaired, replace, or at the option of DUNBARTON, the purchase price of the frame or part will be refunded and does not include labor, installation costs, finishing costs, or indirect or consequential damages of any nature. Some states do not allow the exclusion or limitation of incidental or consequential damages, so the above limitation or exclusion may not apply to you.

This warranty gives you specific legal rights, and you may also have other rights which vary from state to state.

# Specifications

## PART 1 GENERAL

### 1.1 DESCRIPTION

- A. Furnish factory prefinished or primed steel door frames for interior and exterior doors. Refer to architectural drawings, schedules, and details for required types and sizes of frames.
- B. See Division 8 for information on doors, hardware, glazing, etc.

### 1.2 QUALITY ASSURANCE

- A. Prefinished or primed steel door frames shall be as manufactured by Rediframe® Products Division.
- B. Approved equal complying with product standards, features, and construction specified herein.
- C. Assembly and installation, including field modifications, shall be performed by qualified workmen who have been approved by the architect or owners' representative.

### 1.3 SUBMITTALS

- A. Submit manufacturer's specifications for fabrication showing details of design, construction, and installation substantiating that products comply with requirements specified.
- B. Submit shop drawings for architects approval including all necessary information for fabrication and installation of the work to be done in this section.
- C. Provide as prototypes, detail drawings, and color chips as needed for selection or approval by the architect.

### 1.4 DELIVERY, STORAGE, AND HANDLING

- A. Deliver prefinished or primed steel frames cartoned, stretch wrapped, and palletized to provide protection during transit and job storage.
- B. Inspect frames upon delivery for damage. Remove and replace damaged or defective frames prior to final inspection.
- C. Store frames at building site under cover. Place cartons on wood sills at least 4" high or otherwise store on floors in a manner that will prevent rust and damage.

## PART 2 PRODUCTS

### 2.1 FRAMES

- A. Roll form or break frames to sizes and shapes shown on approved drawings.
- B. Hinge jambs shall be embossed for template hinges and reinforced with a zinc plated 14-gauge gusset.

### C. Strike jambs shall be embossed for 2 3/4"

T-strike, 4 7/8"adjustable ASA strike or 2 3/4" deadbolt strike as specified.

### D. Each frame shall be punched around the perimeter of the face to anchor the frame to the wall.

### E. Frames shall be lanced on the face of the frame when snap-on casing is to be applied.

### F. Frames shall be punched for vision slot with nail holes only when wood molding is to be applied.

### G. Standard steel snap-on casing shall be manufactured in 22-gauge cold-rolled or galvanized (A40) (option) steel or .050" aluminum extrusion 6063T5 alloy. S56 steel colonial casing shall be manufactured in cold-rolled or galvanized (A40) (option) steel and be a minimum of 2-1/4" width.

### H. Wood molding to be supplied by others.

## 2.2 TYPES

### A. 16, 18 (standard) and 20 Gauge Steel cold-rolled or galvanized steel to be used in commercial applications.

### B. 18-gauge non-kerf adjustable throat frame, cold-rolled or galvanized steel.

### C. 20-gauge non-kerf adjustable throat frame, cold-rolled or galvanized steel.

### D. 18-gauge kerfed adjustable throat frame, cold-rolled or galvanized steel.

### E. 20-gauge kerfed adjustable throat frame, cold-rolled or galvanized steel.

## 2.3 FINISHES

### A. Rediframe® finish shall be electrostatically baked on enamel on a cleaned and phosphate-treated surface with paint film thickness approximately 1.0 mil.

### B. Provide touch-up paint for all factory prefinished frames.

## PART 3 EXECUTION

### A. Verify opening dimensions with the architectural plans and shop drawings.

### B. Install frames plumb and square using the door as a template to assure alignment of the door and frame.

### C. Secure the frame to the wall per manufacturer's specifications.

### D. Repair all damaged or defective frames prior to job closeout or final inspection.



ORCHARD HILLS APARTMENTS  
IRVINE, CALIFORNIA  
REDIFRAME



1101 Technology Drive | Dothan, Alabama 36303  
800.633.7553 | 334.794.9184 fax  
www.dunbarton.com | sales@dunbarton.com