



NATURAL WOVEN SHADES

PANEL TRACK

Effective September 17, 2018

design simplified™

TABLE OF CONTENTS

Product Overview

- Features & Benefits..... 2
- Color Charts 3

Product Specifications

- Product Characteristics 4
- Options and Features..... 4
- Product Specifications & Configurations 5-6

Pricing

- Price Group 17
- Price Group 28
- Price Group 39
- Price Group 410
- Options & Surcharges11

- Measuring and Installation Specifications12

Oversize Common Carrier Delivery

All orders with any quantity of shades or blinds or any continuous valance 96" or more in width are considered oversize. Therefore, a net shipping charge of \$95.00 per order will be assessed.

Oversized orders that require expedited shipping will be quoted and charged accordingly.

Please see General Information for additional freight and shipping charge information.

FEATURES & BENEFITS



- Offered in a nice selection of Natural Woven Wood, Select Weave, and Grass Weave styles featuring unique patterns and warm, rich tones
- Optional fixed translucent & room darkening liners provide additional privacy and a neutral outside appearance
- Twill edge-bindings frame the individual panels using a high-quality sewing process, adding a decorative finishing touch, and also providing additional panel structure and support
- Coordinated wood wand complements the natural look and provides convenient operation.
- Offers an excellent configuration to cover sliding glass doors and extra wide windows
- Available in side stack, split stack and free-floating panel configurations along with optional valances
- Limited Lifetime Warranty ensures your customers' satisfaction

COLOR CHARTS

WOVEN WOOD COLOR CHART

COLLECTION	COLOR #	COLOR NAME	TWILL EDGE-BINDING COLOR NAME	TWILL EDGE-BINDING* COLOR #
------------	---------	------------	-------------------------------------	-----------------------------------

Price Group 1 Panel Track

ELI	2104	Nagoya Harvest	Mocha	417 & 817
TER	2011	Sonora Desert	Mocha	417 & 418

Price Group 2 Panel Track

EXO	2052	Serengeti Sunrise	Mocha	417 & 817
EXO	2053	Serengeti Cocoa	Chocolate	418 & 818
CUL	2072	Hunan	Mocha	417 & 817
EXO	2150	Sumatra Surprise	Desert	412 & 812
EXO	2232	Taos	Steel	421 & 821

Price Group 3 Panel Track

EXO	2054	Indo Chic	Black	424 & 824
EXO	2068	Kiribati Jungle	Mocha	417 & 817
EXO	2069	Kiribati Rainforest	Chocolate	418 & 818

Price Group 4 Panel Track

CUL	2070	Tobago	Mocha	417 & 817
CUL	2085	Antiqua Maze	Desert	412 & 812
CUL	2086	Antiqua Surf	Jute	409 & 809
EXO	2096	Zulu	Espresso	419 & 819
ELI	2153	Sakura Etude	Espresso	419 & 819

Standard 5/8" twill edge-bindings are represented by the 4xx numbers.
Optional 1-1/2" twill edge-bindings are represented by the 8xx numbers.

** Note: Twill edge-binding colors White, Duck, Latte, and Silver are not available in 1-1/2" widths.

IMPORTANT NOTE ABOUT NATURAL WOVEN MATERIALS:

Our Woven Wood shades are uniquely constructed from natural bamboo, reeds, jutes, rattan, grasses and woods. Many materials, such as natural grasses, are hand tied and braided with expert care. Each woven wood shade is one of a kind. Slight cracks, wood imperfections and variations in color are all inherent in natural products and are not considered flaws.

SELECT & GRASS WEAVES COLOR CHART

COLLECTION	COLOR #	COLOR NAME	TWILL EDGE-BINDING COLOR NAME	TWILL EDGE-BINDING* COLOR #
------------	---------	------------	-------------------------------------	-----------------------------------

Price Group 1 Panel Track

GRW	2305	Coban Parchment	White	400**
GRW	2337	Singapore Bisque	Beige	408 & 808
GRW	2338	Singapore Talc	Dusk	405 & 805
GRW	2339	Singapore Cotton	White	400**
GRW	9410	Coban Gray	Silver	420**
GRW	9450	Singapore Gray	Steel	421 & 821
GRW	9474	Celebes Cornsilk	Dusk	405 & 805
GRW	9475	Celebes Seashell	Silver	420**
GRW	9476	Celebes Ivory	Silver	420**

Price Group 2 Panel Track

GRW	2304	Caracas Tortoise	Beige	408 & 808
GRW	2310	Granada Cinnamon	Jute	409 & 809
GRW	2311	Granada Ginger	Duck	403**
GRW	2312	Granada Nutmeg	Camel	410 & 810
GRW	2331	Nassau Pewter	Latte	404**
GRW	2340	St. Lucia Sand	Duck	403**
GRW	2343	St. Lucia Stom	Steel	421 & 821
GRW	2345	Zaire Camel	Duck	403**
GRW	2346	Zaire Earth	Jute	409 & 809
GRW	9420	Granada Bark	Espresso	419 & 819
GRW	9440	Nassau Cocoa	Chocolate	418 & 818

Price Group 3 Panel Track

GRW	2323	Luzon Whisper	White	400**
GRW	2324	Luzon Cornsilk	Duck	403**
GRW	2325	Luzon Greige	Silver	420**
GRW	9400	St. Kitts Dune	Dusk	405 & 805
GRW	9401	St. Kitts Greywood	Silver	420**
GRW	9460	Aruba Summer	White	400**
GRW	9461	Aruba Straw	Duck	403**
GRW	9462	Aruba Sand Dune	Beige	408 & 808
GRW	9463	Aruba Driftwood	Silver	420**
GRW	9464	Aruba Café	Espresso	419 & 819
GRW	9470	Martinique White Wash	White	400**
GRW	9471	Martinique Sea Grass	Duck	403**
GRW	9472	Martinique Surf	Silver	420**
GRW	9473	Martinique Coral	Jute	409 & 809
SLW	2420	Macau	Mocha	417 & 817
SLW	2423	Mali Tan	Duck	403**
SLW	2436	Tai White	White	400**
SLW	2438	Suva	Mocha	417 & 817
SLW	2526	Salvador Driftwood	Steel	421 & 821
SLW	2527	Cancun Light Gray	Duck	403**
SLW	2528	Cancun Off White	Natural	402 & 802
SLW	2529	Cano Cream	Sand	406 & 806
SLW	2530	Madeira Green	Jute	409 & 809
SLW	2531	Rio Gray	Silver	420**

Price Group 4 Panel Track

SLW	2411	Jaipur Natural	Natural	402 & 802
SLW	2417	Lagos	Duck	403**
SLW	2419	Lomaloma	Duck	403**
SLW	2431	Santos Natural	Duck	403**
SLW	2433	Sintra Dust	Duck	403**
SLW	2441	Tunisia	Natural	402 & 802

Standard 5/8" twill edge-bindings are represented by the 4xx numbers.
Optional 1-1/2" twill edge-bindings are represented by the 8xx numbers.

** Note: Twill edge-binding colors White, Duck, Latte, and Silver are not available in 1-1/2" widths.

PRODUCT CHARACTERISTICS

Product Characteristics

- Panels do not hang perfectly flat.
- Panel materials may have (billowing/waviness) effect.
- Pattern matching from panel to panel cannot be guaranteed, although the factory will make every effort to match patterns as close as possible.

• **NOTE: Material Stretching** – twill edge-bindings come standard to minimize the stretching effect; however you should anticipate that panels may still **stretch up to 1" length**; also, each panel may stretch differently causing panel bottoms to not be perfectly level from panel to panel

OPTIONS AND FEATURES

3-Sided Cotton Twill Edge-Binding

- 5/8" twill edge-binding comes standard.
- Optional 1-1/2" twill edge-binding available at **5%** additional charge.
- On panel sides, twill edge-binding is folded & sewn.
- On panel top, twill edge-binding is attached to front side of panel.
- No twill edge-binding on bottom hem.
- Color-coordinated twill edge-binding by factory, or specify optional tape color.

Natural characteristics of binding results in slight waviness

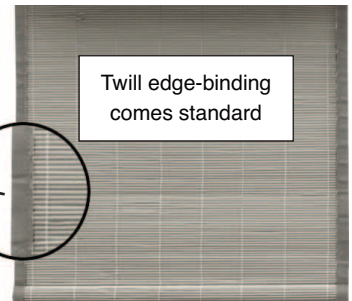

Attached Translucent and Room-Darkening Liner – 10% Additional Charge

- Provides additional light and privacy control.
- Neutral appearance to the outside.
- Refer to sample book for fixed liner colors.

Family	Color #	Color Name
Translucent	LF-1001	White
Translucent	LF-1002	Ivory
Translucent	LF-1003	Khaki
Room Darkening	RD-3008	Beige-Deluxe
Room Darkening	RD-3009	Taupe-Deluxe
Room Darkening	RD-2001	White
Room Darkening	RD-2002	Ivory
Room Darkening	RD-2003	Khaki
Room Darkening	RD-2004	Brown
Room Darkening	RD-2006	Black

Translucent fixed privacy liners are made of 100% Cotton.

Room-Darkening and Blackout fixed privacy liners are made of 30% Cotton and 70% Polyester.

Panel Attachment

- Heavy-duty Velcro sewn to backside of material.
- Provides easy panel installation & removal from carrier glides.



Bottom Hem

- Weighted enclosed bottom hem.



PRODUCT SPECIFICATIONS & CONFIGURATIONS

How To Order

Controls

- Must specify control type with order – cord, wand, free floating (with wands).
- Cord control length is 10" less than ordered length.
- Wand draw is available on all shades; Wood wand sizes: 36"
- Some configurations require dual wands. Lead panel on each side will come with a wand.

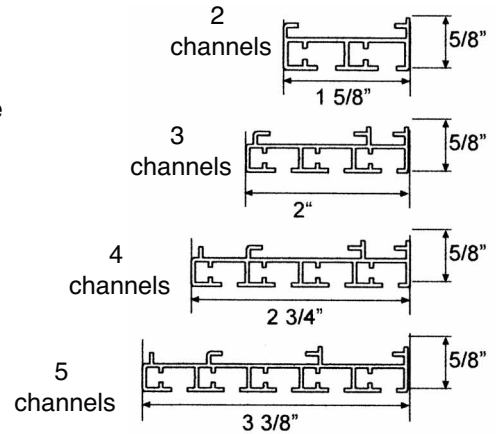

Panel Stack Configurations

- Specify panel configuration from choices below.
 - Approximately 3" material overlap when panels in fully closed position.
 - Each stacking side will have 1 fixed panel.
 - Optional **“free-floating”** panels available at **10% Additional Charge**.
 - Free-floating panels available on one-way up to 5 panels only.
- No split-draw or multi-stack configurations.

Each panel comes with wand.

Panels not interconnected with each other; each panel hand operated independently and can be positioned any place along the track.

Number of Panels	Select Weaves (Overall Width)	Woven Wood & Grass Weaves (Overall Width)	Stack Position / Configurations ("Room View" - Each stacking side will have 1 fixed panel)		
			Single Stack Left Stack	Single Stack Right Stack	Split Stack Note: Come with Dual Wand (if ordered with wand control)
2 Panels (1 overlap)	33" - 89"	21" - 89"	2L – two panels stack left (2 channel track) 	2R – two panels stack right (2 channel track) 	NA
3 Panels (2 overlaps)	48" - 132"	30" - 132"	3L – three panels stack left (3 channel track) 	3R – three panels stack right (3 channel track) 	NA
4 Panels (2 or 3 overlaps depending on number of stacks)	63" - 175"	39" - 175"	4L – four panels stack left (4 channel track) 	4R – four panels stack right (4 channel track) 	2L2R – two panels stack left, two panels stack right (2 channel track)
5 Panels (4 overlaps)	78" - 218"	48" - 218"	5L – five panels stack left (5 channel track) 	5R – five panels stack right (5 channel track) 	NA
6 Panels (5 overlaps)	93" - 261"	57" - 261"	NA	NA	3L3R – three panels stack left, three panels stack right (3 channel track)
8 Panels (7 overlaps)	123" - 261"	75" - 261"	NA	NA	4L4R – four panels stack left, four panels stack right (4 channel track)
10 Panels (9 overlaps)	152" - 261"	93" - 261"	NA	NA	5L5R – five panels stack left, five panels stack right (5 channel track)

PRODUCT SPECIFICATIONS

Panel Track Headrail

- White painted aluminum profile.
- See mounting depth requirements for panel track sizes.

Panel Track Splice

- Automatically comes with any window opening over 144" wide – track ships from factory in (2) equal size pieces.
- Recommended (request when placing order) with window openings over 100" wide to reduce risk of freight damage and to provide easier handling by installers.
- Splice plate easily & securely connects separate tracks together to operate as a single track unit.
- Installers prefer the convenience of handling smaller tracks onto the jobsite, then connecting together at installation.

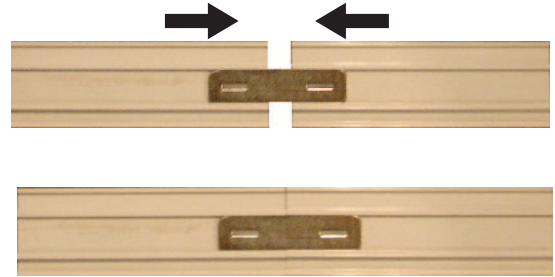

Panel Size / Stacking Width

- **18" Minimum Panel Width – Select Weaves**
- **12" Minimum Panel Width – all other styles**
- **46" Maximum Panel Width**
- Individual panel size varies depending on overall shade width & panel configuration.

NOTE: The smaller the panel width, the narrower the stacking space.

To calculate stacking width; overall width + (number of overlaps x 3) then divide by number of panels.

Example # 1 – 3 panel 112" W + 6 (2 overlaps x 3 = 6) = 118 divide by 3 panels = 39-3/8" stacking / panel width

Example # 2 – 4 panel 112" W + 9 (3 overlaps x 3 = 9) = 121 divide by 4 panels = 30-1/4" stacking / panel width

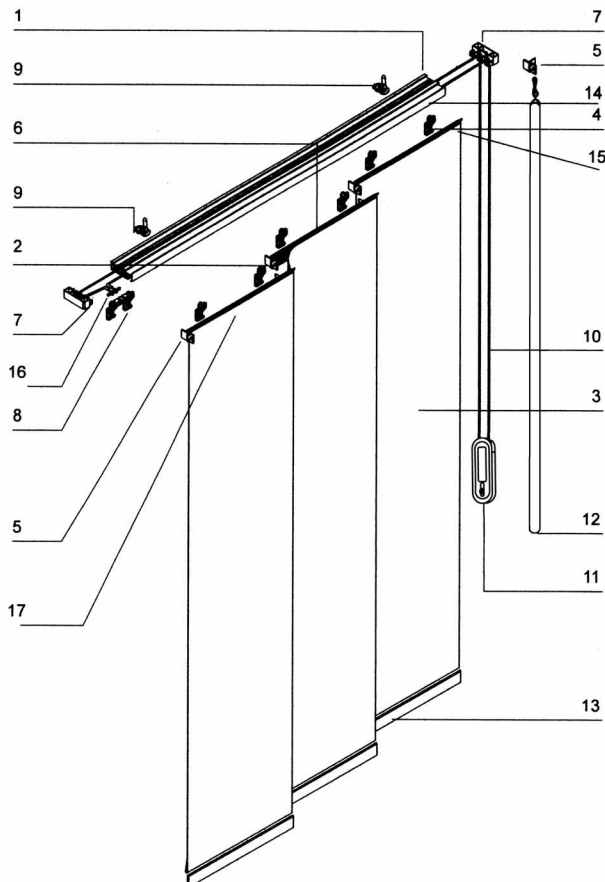

- | | |
|-----------------------------------|----------------------------|
| 1. Aluminum Track | 10. Cord |
| 2. Sliding Panel w/Velcro | 11. Tensioner |
| 3. Woven Material | 12. Control Wand |
| 4. Support w/Needle | 13. Flat Weight |
| 5. Double L Bracket Angle | 14. Panel Stop Screw |
| 6. L-Bracket Angle | 15. End Cap |
| 7. Channel Guide | 16. Brass Cord Locking Nut |
| 8. Double Support (front or Back) | 17. Velcro Velour |
| 9. Installation Clip | 18. Splice (not pictured) |

// Natural Woven Panel Track



NOTE: Panel Tracks over 144" wide are spliced together at installation.

- ② **ELI**
2104 Nagoya Harvest
- ② **GRW**
9474 Celebes Cornsilk
9476 Celebes Ivory
9475 Celebes Seashell
9410 Coban Gray
2305 Coban Parchment
2337 Singapore Bisque
2339 Singapore Cotton
9450 Singapore Gray
2338 Singapore Talc
- ② **TER**
2011 Sonora Desert

Price Group 1

2 PANEL ② min width = 21"

WIDTH TO:	36"	48"	60"	72"	84"	89"
HEIGHT TO:						
36"	\$368	422	478	554	608	628
48"	410	471	538	622	680	713
60"	456	519	596	698	763	791
72"	499	580	666	774	852	892
84"	535	621	713	827	906	950
96"	560	658	750	882	967	1012
108"	595	692	799	933	1028	1075
Track	236	258	285	326	349	360

3 PANEL ② min width = 30"

WIDTH TO:	36"	48"	60"	72"	84"	96"	108"	120"	132"
HEIGHT TO:									
36"	\$452	504	561	639	698	749	810	893	946
48"	496	558	626	715	782	852	909	996	1064
60"	542	616	692	789	871	935	1009	1114	1196
72"	595	675	758	868	961	1040	1122	1238	1334
84"	628	722	812	930	1034	1122	1211	1337	1410
96"	661	766	863	976	1089	1184	1293	1402	1520
108"	692	799	898	1032	1141	1257	1359	1495	1607
Track	298	322	349	394	423	447	473	523	549

4 PANEL ② min width = 39"

WIDTH TO:	48"	60"	72"	84"	96"	108"	120"	132"	144"	156"	168"	175"
HEIGHT TO:												
36"	\$580	635	721	784	845	897	989	1048	1102	1195	1248	1275
48"	639	706	804	871	933	1002	1110	1176	1234	1337	1387	1434
60"	701	774	889	959	1038	1110	1218	1310	1374	1469	1556	1589
72"	763	852	968	1058	1148	1233	1342	1441	1531	1636	1715	1771
84"	813	898	1031	1125	1207	1315	1454	1543	1639	1752	1857	1895
96"	855	953	1085	1185	1289	1391	1526	1638	1742	1864	1973	2017
108"	896	1009	1146	1253	1371	1484	1613	1732	1841	1971	2086	2131
Track	\$381	411	457	487	513	542	598	621	652	702	730	740

PANEL ONLY ② min width = 12" max width = 46"

WIDTH TO:	12"	24"	30"	36"	46"
HEIGHT TO:					
36"	\$116	150	173	196	228
48"	131	171	198	226	262
60"	145	194	226	256	300
72"	158	217	253	288	337
84"	170	235	277	315	370
96"	182	254	295	338	401
108"	192	269	317	363	429

5 - 10 PANEL ② 5 Panel min width = 48" ② 6 Panel min width = 57" ② 8 Panel min width = 75" ② 10 Panel min width = 93"

WIDTH TO:	72"	84"	96"	108"	120"	132"	144"	156"	168"	180"	192"	204"	216"	228"	240"	252"	261"
HEIGHT TO:																	
36"	740	800	855	920	1002	1048	1110	1195	1248	1311	1375	1454	1503	1567	1645	1712	1755
48"	815	881	943	1015	1095	1162	1234	1322	1387	1455	1527	1613	1669	1736	1823	1901	1948
60"	886	959	1038	1110	1204	1294	1372	1469	1540	1618	1696	1793	1853	1934	2029	2115	2166
72"	968	1058	1148	1233	1326	1425	1510	1618	1696	1779	1865	1976	2066	2131	2235	2329	2385
84"	1027	1113	1207	1298	1418	1506	1599	1715	1816	1905	2003	2118	2189	2282	2395	2495	2555
96"	1071	1173	1274	1375	1489	1599	1700	1823	1909	2027	2104	2227	2327	2424	2546	2650	2715
108"	1125	1240	1341	1447	1574	1670	1798	1927	2017	2142	2224	2354	2462	2560	2690	2799	2870
Track	\$529	561	592	624	682	709	750	796	830	870	894	953	986	1009	1063	1095	1125

Separate Valance

WIDTH TO:	36"	48"	60"	72"	84"	96"	108"	120"	132"	144"
Inside 6" Valance	\$74	91	140	161	190	221	241	267	307	326
Outside 6" Valance	95	116	167	190	221	251	276	303	344	364
Each Additional 3" Height	14	18	23	26	29	31	34	36	40	40
Add Valance Liner	26	36	47	57	67	78	85	93	106	111

② **CUL**
2072 Hunan

② **EXO**
2052 Serengeti Sunrise
2053 Serengeti Cocoa
2150 Sumatra Surprise
2232 Taos

② **GRW**
2304 Caracas Tortoise
2310 Granada Cinnamon
2311 Granada Ginger
2312 Granada Nutmeg
9420 Granada Bark
2331 Nassau Bark
9440 Nassau Cocoa
2340 St. Lucia Sand
2343 St. Lucia Storm
2345 Zaire Camel
2346 Zaire Earth

NOTE: Select Weave fabrics maximum height is 96". Panel Tracks over 144" wide are spliced together at installation.

Price Group 2

2 PANEL ② min width = 21" 

WIDTH TO:	36"	48"	60"	72"	84"	89"
HEIGHT TO:						
36"	\$391	449	511	589	652	680
48"	437	504	581	677	749	775
60"	487	565	658	761	844	884
72"	543	638	734	853	950	993
84"	581	689	786	922	1027	1072
96"	616	728	842	981	1103	1151
108"	653	771	899	1054	1178	1227
Track	236	258	285	326	349	360

3 PANEL ② min width = 30" 

WIDTH TO:	36"	48"	60"	72"	84"	96"	108"	120"	132"
HEIGHT TO:									
36"	\$471	535	599	680	746	808	870	953	1010
48"	523	601	675	769	844	925	994	1087	1161
60"	581	665	747	867	950	1039	1116	1228	1304
72"	642	740	833	953	1058	1156	1252	1378	1465
84"	688	793	890	1031	1151	1248	1364	1487	1587
96"	724	832	956	1098	1211	1346	1457	1597	1712
108"	755	884	1012	1169	1290	1430	1551	1703	1830
Track	298	322	349	394	423	447	473	523	549

4 PANEL ② min width = 39" 

WIDTH TO:	48"	60"	72"	84"	96"	108"	120"	132"	144"	156"	168"	175"
HEIGHT TO:												
36"	\$612	675	759	825	889	960	1054	1119	1187	1282	1345	1372
48"	682	759	855	937	1004	1081	1197	1270	1346	1436	1521	1553
60"	755	837	952	1048	1136	1208	1343	1428	1514	1629	1707	1760
72"	830	930	1058	1156	1256	1360	1495	1587	1685	1828	1917	1974
84"	886	994	1130	1248	1363	1468	1620	1718	1824	1980	2077	2138
96"	931	1055	1201	1312	1443	1572	1723	1847	1959	2105	2209	2297
108"	987	1116	1266	1399	1536	1677	1843	1955	2096	2250	2363	2459
Track	\$381	411	457	487	513	542	598	621	652	702	730	740

② min width = 12"
max width = 46"

PANEL ONLY

WIDTH TO:	12"	24"	30"	36"	46"
HEIGHT TO:					
36"	\$121	162	188	216	248
48"	139	188	217	250	292
60"	154	214	250	288	338
72"	172	242	282	323	382
84"	185	262	311	355	423
96"	198	285	334	387	460
108"	211	307	362	419	494

5 - 10 PANEL

5 Panel ② min width = 48"
8 Panel ② min width = 75"

6 Panel ② min width = 57"
10 Panel ② min width = 93"

WIDTH TO:	72"	84"	96"	108"	120"	132"	144"	156"	168"	180"	192"	204"	216"	228"	240"	252"	261"
HEIGHT TO:																	
36"	777	840	906	972	1054	1119	1183	1282	1345	1412	1479	1564	1623	1695	1695	2006	2070
48"	860	937	1013	1094	1184	1256	1341	1436	1505	1582	1659	1756	1819	1901	1901	2295	2331
60"	953	1048	1125	1208	1329	1412	1492	1596	1690	1775	1864	1971	2043	2138	2138	2567	2619
72"	1053	1145	1242	1345	1464	1553	1659	1775	1880	1973	2070	2190	2294	2383	2383	2865	2951
84"	1122	1236	1335	1435	1567	1663	1782	1902	2015	2115	2217	2349	2462	2583	2583	3102	3195
96"	1181	1300	1413	1536	1666	1769	1915	2043	2164	2275	2387	2528	2619	2748	2748	3302	3404
108"	1253	1372	1505	1621	1762	1891	2025	2162	2293	2405	2528	2675	2803	2937	2937	3533	3642
Track	\$529	561	592	624	682	709	750	796	830	870	894	953	986	1009	1063	1095	1125

Separate Valance

WIDTH TO:	36"	48"	60"	72"	84"	96"	108"	120"	132"	144"
Inside 6" Valance	\$74	91	140	161	190	221	241	267	307	326
Outside 6" Valance	95	116	167	190	221	251	276	303	344	364
Each Additional 3" Height	14	18	23	26	29	31	34	36	40	40
Add Valance Liner	26	36	47	57	67	78	85	93	106	111

- ② **EXO**
2054 Indo Chic
2068 Kiribati Jungle
2069 Kiribati Rainforest
- ② **GRW**
2323 Luzon Whisper
2324 Luzon Cornsilk
2325 Luzon Greige
9400 St. Kitts Dune
9401 St. Kitts Greywood
9460 Aruba Summer
9461 Aruba Straw
9462 Aruba Sand Dune
9463 Aruba Driftwood
9464 Aruba Cafe
9470 Martinique White Wash
9471 Martinique Sea Grass
9472 Martinique Surf
9473 Martinique Coral
- ① **SLW**
2527 Cancun Light Gray
2528 Cancun Off White
2529 Cano Cream
2420 Macau
2530 Madeira Green
2423 Mali Tan
2531 Rio Gray
2526 Salvador Driftwood
2438 Suva
2436 Tai White

NOTE: Select Weave fabrics maximum height is 96". Panel Tracks over 144" wide are spliced together at installation.

Price Group 3

2 PANEL ① min width = 33"
 ② min width = 21"

WIDTH TO:	36"	48"	60"	72"	84"	89"
HEIGHT TO:						
36"	\$394	459	527	614	673	699
48"	447	526	601	708	782	808
60"	504	597	687	804	884	931
72"	561	665	774	899	1002	1043
84"	606	717	837	981	1094	1140
96"	648	773	904	1054	1174	1233
108"	688	827	973	1128	1263	1323
Track	236	258	285	326	349	360

3 PANEL ① min width = 48"
 ② min width = 30"

WIDTH TO:	36"	48"	60"	72"	84"	96"	108"	120"	132"
HEIGHT TO:									
36"	\$478	541	610	701	769	834	896	986	1058
48"	536	613	690	793	882	954	1033	1135	1212
60"	596	687	786	894	993	1094	1181	1295	1389
72"	664	770	875	1002	1114	1227	1322	1464	1558
84"	713	826	945	1084	1211	1326	1443	1580	1706
96"	757	883	1013	1175	1298	1428	1555	1713	1839
108"	799	934	1080	1248	1380	1520	1670	1828	1966
Track	298	322	349	394	423	447	473	523	549

4 PANEL ① min width = 63"
 ② min width = 39"

WIDTH TO:	48"	60"	72"	84"	96"	108"	120"	132"	144"	156"	168"	175"
HEIGHT TO:												
36"	\$617	688	781	848	915	983	1091	1158	1228	1322	1387	1430
48"	698	774	881	966	1045	1119	1238	1326	1406	1511	1584	1648
60"	780	863	990	1081	1182	1278	1404	1505	1596	1711	1813	1864
72"	867	967	1099	1214	1318	1435	1577	1689	1791	1917	2050	2107
84"	925	1043	1186	1311	1431	1550	1707	1829	1941	2077	2220	2282
96"	973	1106	1270	1404	1545	1676	1836	1967	2085	2250	2385	2451
108"	1042	1189	1350	1492	1645	1789	1964	2104	2229	2408	2553	2623
Track	\$381	411	457	487	513	542	598	621	652	702	730	740

PANEL ONLY ① min width = 18"
 ② min width = 12"
 max width = 46"

WIDTH TO:	12"	24"	30"	36"	46"
HEIGHT TO:					
36"	\$124	168	198	224	264
48"	142	197	231	262	314
60"	157	227	264	307	362
72"	179	256	300	348	414
84"	191	282	334	382	461
96"	206	307	362	419	508
108"	221	329	389	453	546

5 - 10 PANEL **5 Panel** ① min width = 78" ② min width = 48" **6 Panel** min width = 93" ② min width = 57"
8 Panel ① min width = 123" ② min width = 75" **10 Panel** min width = 152" ② min width = 93"

WIDTH TO:	72"	84"	96"	108"	120"	132"	144"	156"	168"	180"	192"	204"	216"	228"	240"	252"	261"
HEIGHT TO:																	
36"	816	887	961	1029	1116	1184	1263	1363	1430	1501	1573	1665	1713	1796	1897	1962	2006
48"	917	1004	1075	1157	1266	1356	1428	1542	1617	1699	1782	1895	1980	2036	2171	2222	2295
60"	1017	1124	1204	1306	1433	1521	1621	1727	1830	1921	2017	2136	2241	2336	2435	2540	2619
72"	1145	1238	1342	1450	1592	1689	1816	1953	2070	2172	2279	2391	2508	2624	2731	2865	2951
84"	1211	1337	1458	1565	1707	1829	1971	2096	2220	2352	2466	2590	2721	2844	2959	3102	3195
96"	1286	1417	1545	1694	1836	1967	2097	2250	2385	2530	2654	2788	2926	3060	3184	3336	3438
108"	1372	1505	1645	1789	1964	2104	2243	2408	2553	2701	2840	2981	3130	3271	3404	3569	3677
Track	\$529	561	592	624	682	709	750	796	830	870	894	953	986	1009	1063	1095	1125

Separate Valance

WIDTH TO:	36"	48"	60"	72"	84"	96"	108"	120"	132"	144"
Inside 6" Valance	\$74	91	140	161	190	221	241	267	307	326
Outside 6" Valance	95	116	167	190	221	251	276	303	344	364
Each Additional 3" Height	14	18	23	26	29	31	34	36	40	40
Add Valance Liner	26	36	47	57	67	78	85	93	106	111

NOTE: Select Weave fabrics maximum height is 96". Panel Tracks over 144" wide are spliced together at installation.

- ② **CUL**
2070 Tobago
2085 Antiqua Maze
2086 Antiqua Surf
- ② **ELI**
2153 Sakura Etude
- ② **EXO**
2096 Zulu
- ① **SLW**
2411 Jaipur Natural
2417 Lagos
2419 Lomaloma
2431 Santos Natural
2433 Sintra Dust
2441 Tunisia

Price Group 4

2 PANEL ① min width = 33"
② min width = 21"

WIDTH TO:	36"	48"	60"	72"	84"	89"
HEIGHT TO:						
36"	\$492	574	659	768	841	874
48"	557	658	751	884	978	1010
60"	630	746	858	1005	1104	1165
72"	701	832	967	1125	1253	1305
84"	757	896	1047	1228	1368	1424
96"	810	966	1130	1318	1467	1542
108"	859	1033	1216	1410	1578	1654
Track	236	258	285	326	349	360

3 PANEL ① min width = 48"
② min width = 30"

WIDTH TO:	36"	48"	60"	72"	84"	96"	108"	120"	132"
HEIGHT TO:									
36"	\$596	677	763	876	961	1043	1120	1233	1322
48"	669	767	863	991	1102	1192	1290	1418	1515
60"	745	858	982	1117	1241	1367	1475	1619	1736
72"	831	961	1094	1253	1392	1533	1652	1831	1948
84"	891	1032	1182	1355	1514	1659	1803	1975	2133
96"	947	1103	1267	1469	1622	1785	1944	2141	2299
108"	999	1168	1350	1561	1725	1900	2088	2284	2458
Track	298	322	349	394	423	447	473	523	549

4 PANEL ① min width = 63"
② min width = 39"

WIDTH TO:	48"	60"	72"	84"	96"	108"	120"	132"	144"	156"	168"	175"
HEIGHT TO:												
36"	\$771	859	976	1060	1144	1229	1363	1448	1535	1652	1733	1787
48"	872	967	1100	1207	1306	1398	1547	1659	1757	1889	1980	2060
60"	975	1079	1238	1351	1477	1598	1755	1882	1994	2138	2266	2331
72"	1084	1208	1374	1518	1647	1793	1971	2111	2239	2396	2563	2635
84"	1156	1303	1483	1639	1788	1936	2134	2286	2425	2596	2776	2853
96"	1216	1383	1587	1755	1931	2096	2295	2460	2605	2814	2982	3065
108"	1302	1487	1687	1865	2057	2237	2455	2630	2785	3010	3190	3279
Track	\$381	411	457	487	513	542	598	621	652	702	730	740

PANEL ONLY ① min width = 18"
② min width = 12"
max width = 46"

WIDTH TO:	12"	24"	30"	36"	46"
HEIGHT TO:					
36"	\$155	210	247	280	330
48"	177	247	288	328	392
60"	197	284	330	383	452
72"	224	319	375	435	518
84"	238	352	416	478	576
96"	258	383	452	523	634
108"	277	412	486	566	683

5 - 10 PANEL **5 Panel** ① min width = 78" ② min width = 48"
8 Panel ① min width = 123" ② min width = 75" **6 Panel** ① min width = 93" ② min width = 57"
10 Panel ① min width = 152" ② min width = 93"

WIDTH TO:	72"	84"	96"	108"	120"	132"	144"	156"	168"	180"	192"	204"	216"	228"	240"	252"	261"
HEIGHT TO:																	
36"	1020	1109	1202	1286	1396	1479	1578	1704	1787	1876	1966	2081	2141	2245	2372	2452	2507
48"	1146	1255	1345	1447	1582	1695	1785	1927	2021	2124	2227	2368	2475	2545	2712	2778	2868
60"	1271	1405	1505	1633	1790	1901	2027	2159	2288	2401	2522	2670	2801	2920	3044	3175	3273
72"	1431	1547	1677	1813	1991	2111	2270	2441	2587	2714	2849	2989	3135	3280	3414	3581	3688
84"	1514	1671	1822	1957	2134	2286	2463	2620	2776	2939	3082	3238	3400	3555	3699	3878	3995
96"	1608	1772	1931	2117	2295	2460	2621	2814	2982	3163	3318	3484	3657	3825	3980	4170	4298
108"	1716	1882	2057	2237	2455	2630	2804	3010	3190	3376	3551	3726	3913	4088	4255	4461	4596
Track	\$529	561	592	624	682	709	750	796	830	870	894	953	986	1009	1063	1095	1125

Separate Valance

WIDTH TO:	36"	48"	60"	72"	84"	96"	108"	120"	132"	144"
Inside 6" Valance	\$74	91	140	161	190	221	241	267	307	326
Outside 6" Valance	95	116	167	190	221	251	276	303	344	364
Each Additional 3" Height	14	18	23	26	29	31	34	36	40	40
Add Valance Liner	26	36	47	57	67	78	85	93	106	111

PANEL TRACK OPTIONS

Separate Valance Only

- Minimum width: 12" net
- Maximum width: 144"
- Standard valance height 6" – longer heights available (maximum height 24")

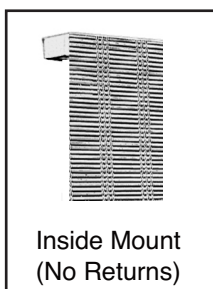

- 3/4" Dust Cover depth.
- Add liner to valance only at extra charge.
- Simple installation; pre-drilled opening in headrail; mount with hex head screws.

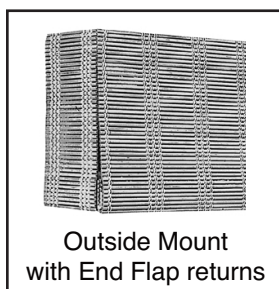

- Standard return depth 6".
- Minimum return depth: 5", maximum return depth 7".
- Add liner to valance only at extra charge.
- Simple installation; pre-drilled opening in headrail; mount with L-Bracket attached to a threaded bolt and wing nut.

Separate Valance

WIDTH TO:	36"	48"	60"	72"	84"	96"	108"	120"	132"	144"
Inside 6" Valance	\$74	91	140	161	190	221	241	267	307	326
Outside 6" Valance	95	116	167	190	221	251	276	303	344	364
Each Additional 3" Height	14	18	23	26	29	31	34	36	40	40
Add Valance Liner	26	36	47	57	67	78	85	93	106	111

Additional Surcharges (Add to base price of Panel Track)

LINERS

- Translucent lineradd 10%
- Room-Darkening lineradd 10%

COTTON TWILL EDGE-BINDING

- 5/8" trim come standardno charge
- 1 1/2" trim sizeadd 5%

MEASURING & INSTALLATION SPECIFICATIONS

Panel Track Brackets



(A)

Inside / Ceiling Mount
Used on 2 and 3 channel track
Bracket Clip
(Part #181-CA-00700)

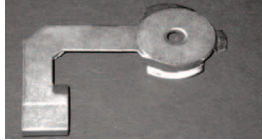

(B)

Inside / Ceiling Mount
Used on 4 and 5 channel track
Bracket Clip
(Part #181-CA-00600)



(C)

Outside / Wall Mount
Used on all tracks
Installation Bracket
(Part #30-CA-06600)

Mounting Depth Requirements

Number Track Channels	IB Mount Flush Mount Depth	IB Mount W/ Valance Flush Mount Depth	IB Mount Minimum Depth	OB Mount Wall Clearance	OB Mount Overall Projection
2	2-1/2"	3-1/2"	1-3/4"	2-1/2" – 3-1/8"	4-1/8" – 4-3/4"
3	2-3/4"	3-3/4"	1-3/4"	2-1/2" – 3-1/8"	4-1/2" – 5-1/4"
4	3-1/2"	4-1/2"	1-3/4"	2-1/2" – 3-1/8"	5-1/4" – 6"
5	3-1/2"	4-1/2"	2"	1-3/4" – 4"	5-1/8" – 7-3/8"

Deductions

	IB Mount	OB Mount
Headrail Width	- 1/4"	net
Panel Height Allowance	- 1/2"	net
Valance	- 1/8"	+2"

How To Measure

Note: Projection of window handles / cranks could interfere with panel track panels . . . refer to "mounting depth requirements" above for projection clearance

Inside Mount (IB) Installation - Window

To find width: Measure the opening across the top where the headrail is to be installed from inside of jamb on left to inside of jamb on right. **Round the measurement down to the nearest 1/8"**. Refer to mounting depth requirements.

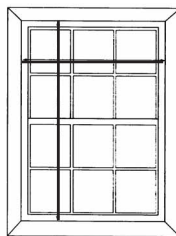

Inside Mount

To find height: Measure from the inside top of the opening on the left, at the center, and on the right to the sill; **round the measurement down to the nearest 1/8" and note the smallest dimension. Do not make any allowances: the factory will make all adjustments so the headrail will fit the opening properly and the panels will clear the sill by 1/2"**.

Outside Mount (OB) Installation - Window

To find width: Measure the width of the area to be covered at the place where the headrail will be installed to the nearest 1/8". Blind should overlap opening at least 4" on each side to ensure privacy. To calculate stack dimensions, refer to page 6.

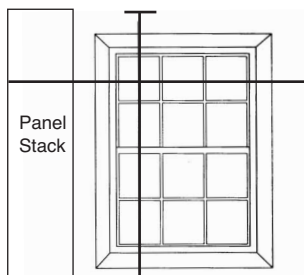

Outside Mount

To find height: Measure the height of the area to be covered and **round down to the nearest 1/8"**. Blind should extend at least 3" above and 3" below opening or window moulding.

Valance Brackets



Outside Mount
3" x 3" L-bracket
for 3-1/4" dust cap



Inside Mount
Hex Head Screw
1-1/2" #8



WARNING

Young children can STRANGLE in cord loops. They can also wrap cords around their necks and STRANGLE.

Child Safety Cord Tensioner

Attach the cord tensioner on the cord loop to the wall or window casement. This can prevent children from pulling cord loops around their necks.

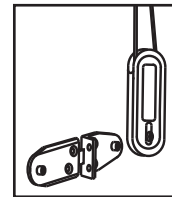

Outside Mount (OB) Installation - Patio Door / Room Divider

To find width: Measure the width of the area to be covered at the place where the headrail will be installed to the nearest 1/8". Blind should overlap opening at least 4" on each side.

To find height: Measure the height of the area to be covered and **round down to the nearest 1/8"**. Blind should extend at least 3" above opening or window moulding.

For ceiling-to-floor installations, deduct 1/2" for proper clearance.

Specifying OB measurement means the factory makes no allowances.

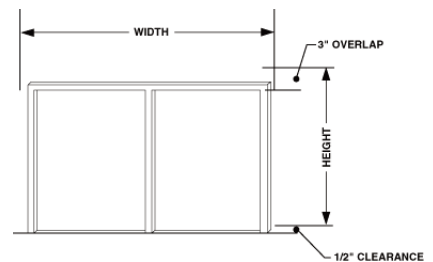

Special Measuring & Installation Considerations

Stretching of panel materials is probable:

IB Mount - we do not recommend IB mount due to probable stretching

OB Mount - extra adjustment recommended for placement of mounting brackets above the floor to anticipate panel material stretching:

- Material can stretch up to 1" length