

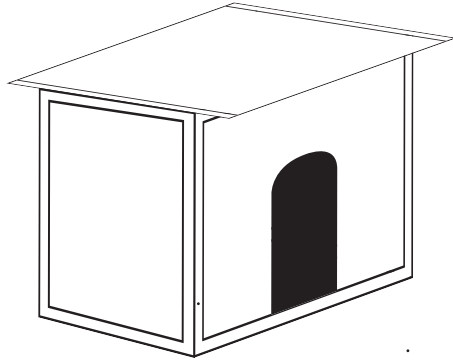

Wood Nesting Hutch
Assembly Instructions

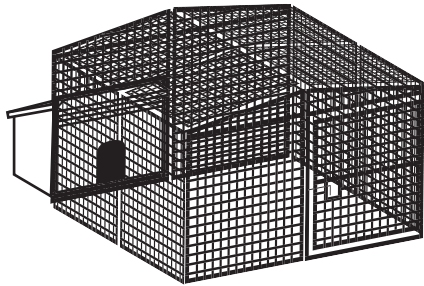

Complete your Wood Hutch by attaching to the Universal Welded Wired Pen!!



Shown with optional Universal Welded Wire Pen.







Important Notes:

Lay out all components prior to start of assembly.

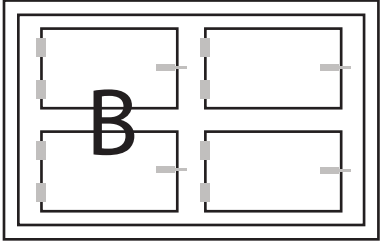
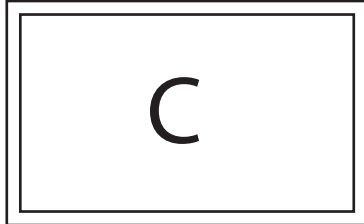
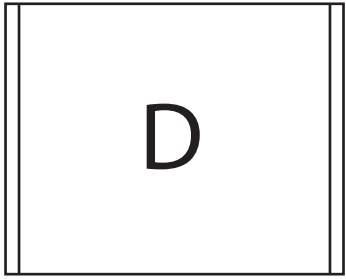
Flat level surface recommended for assembly.

If any components are missing or damaged do not return to retailer. Please call Rugged Ranch Products at: 760-734-3748.

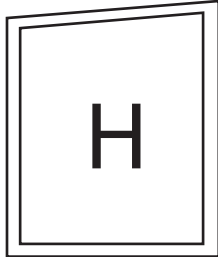
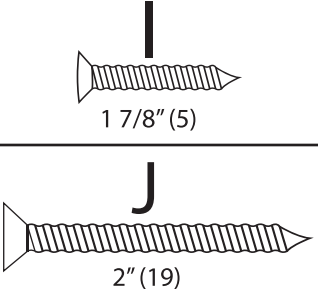
Please visit our website to see our complete line of Rugged Ranch Products.
www.ruggedranch.net

 <p>A</p> <p>Front Panel</p>	 <p>B</p> <p>Back Panel</p>	
 <p>C</p> <p>Bottom Panel</p>	 <p>D</p> <p>Roof Panel</p>	
 <p>E</p> <p>Nesting Box Floor (2)</p>	 <p>F</p> <p>Nesting Box Lip (2)</p>	
 <p>G</p> <p>Center Divide</p>	 <p>H</p> <p>Side Panel (2)</p>	 <p>I 1 7/8" (5)</p> <p>J 2" (19)</p>
 <p>2" x 10" Block (2) - These are used in conjunction with the Universal Welded Wire Pen. If you attach the Wood Hutch to the Welded Wire Pen, these blocks should be screwed on to the back edge to level the hutch and keep it off of the ground.</p>		

Step 1

Stand Front Panel (A) upright and attach both Side Panels (H) using pre-drilled holes in Front Panel (A). Two (2) screws (J) will be used for each side. Ensure that the ledge on Side Panels (H) are facing the inside of the box.

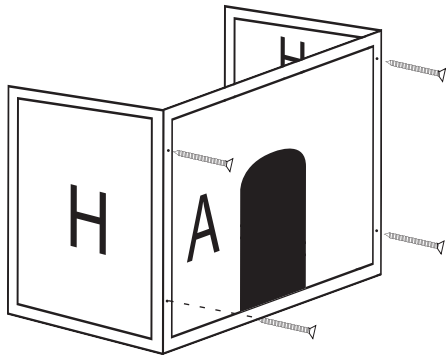

Step 2

Place Floor Panel (C) inside previously constructed panels. Next, attach Back Panel (B) to both Side Panels (H) using (4) screws (J). Two per side.

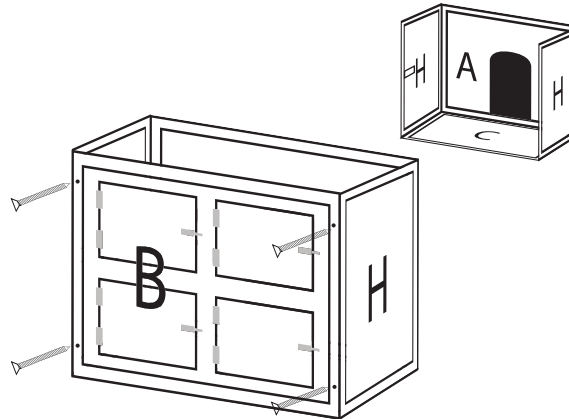

Step 3

Insert Center Divider Panel (G) and attach to Back Panel (B) using (1) screw (J) at pre-drilled hole on Back Panel (B).

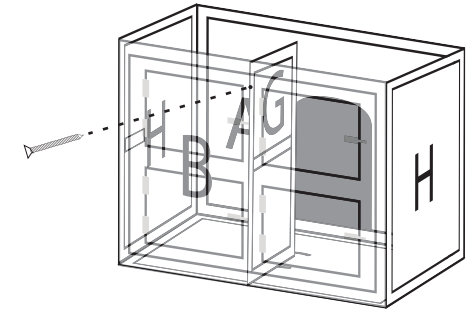

Step 4

Insert both Nesting Box Floor Panels (E) on either side of Center Divide Panel (G). No screws are necessary.

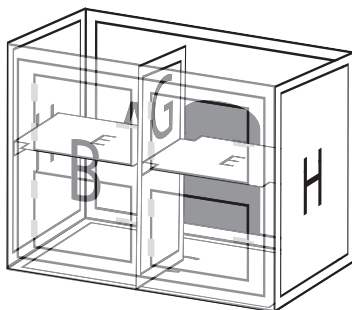

Step 5

Place one Nesting Box Lip (F) on one Center Divide Panel (G) on the Floor Panel (C) and attach using (2) screws (I). Repeat this step for the upper Nesting Box Lip Panel (F).

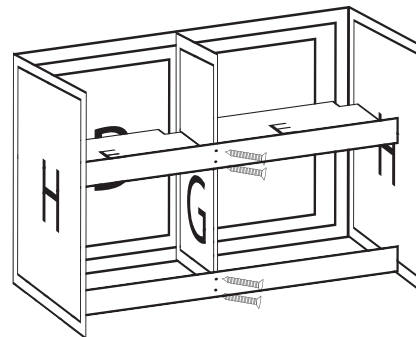

Step 6

Place Roof Panel (D) on top of Wood Hutch. The roof is meant to have overhang on the front and back. You can place it where it suits you and screw in place using (4) screws (J). Also, take the time to place (4) screws (J) into the pre-drilled holes at the bottom of the Front and Back Panels to secure them to the Bottom Panel. You will use (2) screws per side.

