



Prodigy
FORGING ELEGANCE
OMNIA

Timeless Appeal.
Impeccable Quality.

SINCE
1964



Prodigy

FORGED FROM
SOLID BRASS

For over 50 years, **OMNIA** has manufactured elegant, high-quality door hardware forged from solid brass. The **OMNIA Prodigy** collection continues in this legacy, with enduring beauty, durability and affordability in mind.

Inspired by some of our most popular designs, the **OMNIA Prodigy** selection of styles range from sleek metal to sparkling glass. Five different rose styles and **OMNIA's** gorgeous array of finishes allow for superb customization at an *incomparable* value.



Finishes

All OMNIA Prodigy designs are available in the finishes shown here, unless otherwise noted.



Available Roses

All designs are available in seven OMNIA finishes. Certain configurations are also available in US3A, US5 and US26D. **All roses are concealed screw mounted.** Thru-bolted roses for pre-drilled 2 1/8" hole.



Traditional (TD)
2 5/8" diameter



Modern (MD)
2 5/8" diameter



Arched (AR)
2 5/8" W x 3 1/4" H



Rectangular (RT)
2 5/8" W x 3" H



Square (SQ)
2 5/8" square

Latchset Component List

- | | | | |
|----------------------------------|--|--|--|
| A – Door Knob/Lever (2) | G – Tubular Latch Faceplate | L – Privacy Locking Block (For Privacy ONLY) | O – Privacy Locking Pin (For Privacy ONLY) |
| B – Set Screws (2) | H – Tubular Latch Strike Plate | M – Thru-bolts (2) | P – Washer Installation Tool |
| C – Nylon Threaded Washers (2) | I – Metal Spring Assist Sub-Rose | N – Finished Rose | Q – Emergency Release Key |
| D – Finished Rose | J – Privacy Locking Block Machine Screw (For Privacy ONLY) | | |
| E – Metal Spring Assist Sub-Rose | K – Privacy Locking Block Locking Stopper (For Privacy ONLY) | | |
| F – Tubular Latch | | | |

(55° Latch Parts)

- R – Adaptor R
 S – Spindle (Teardrop groove positioned towards set screw)
 T – Tubular Latch
 U – Tubular Latch Faceplate
 V – Adaptor V

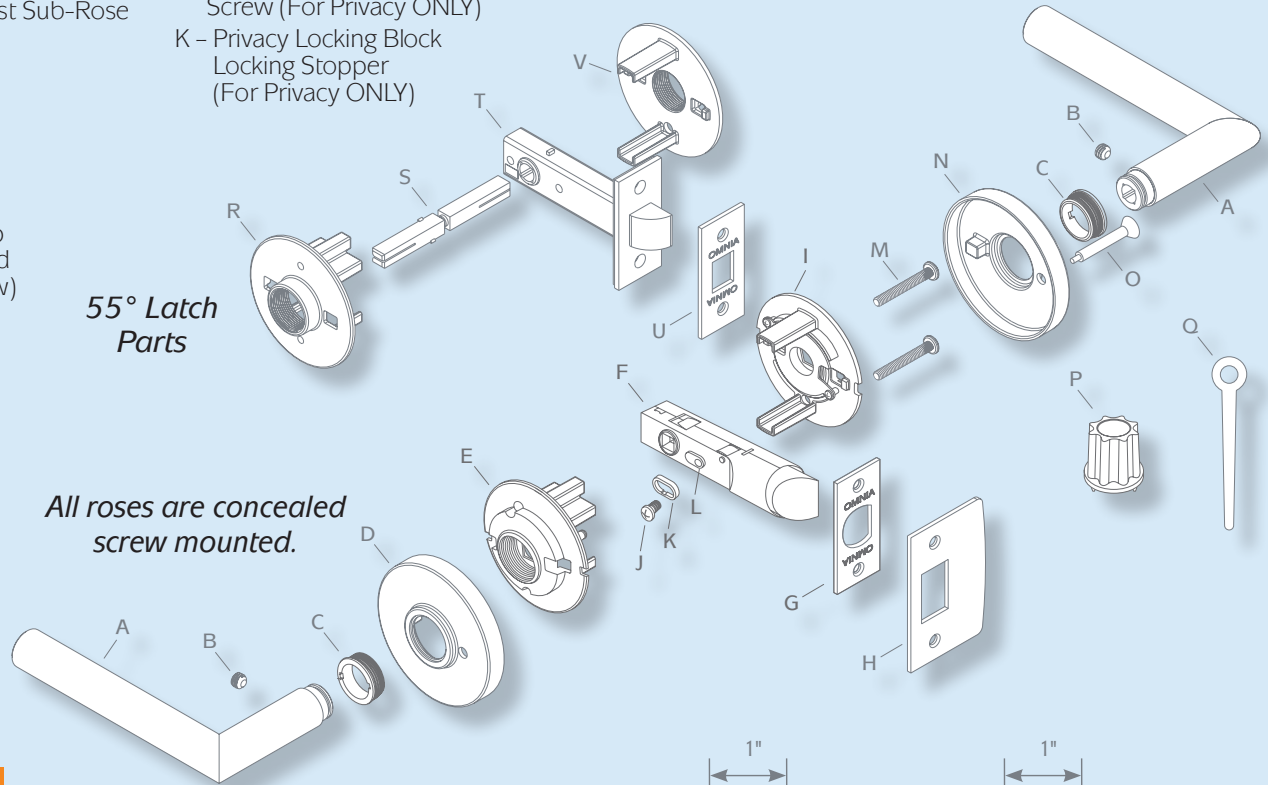

Product Data

Knob and Lever Latchset

- 2 3/8" (standard) and 2 3/4" backsets available.
- Supplied for both 1 3/8" and 1 3/4" door thickness as standard. The minimum door thickness is 1 1/4"; the maximum door thickness is 2 1/2" (*please specify*).
- All lever latchsets meet ADA accessibility requirements.

Each set consists of solid brass knobs or levers, thru-bolted rose mechanisms, finished rose covers, latch, strike, faceplate, spindle, all necessary mounting screws, installation template and instructions.

About Our Tubular Latch

- 55° rotation to retract latch. (For Knobs)
- 28° rotation to retract latch. (For Levers)
- Tough, non-rusting materials used throughout. Face covers and strikes are solid brass. No.014 "Full Lip" strike supplied as standard or No.013 "T" strike as an option. (*Please specify*).
- For over five decades, OMNIA's latches have been opening and closing hundreds of thousands of doors all around the world.

Functions

- **Passage:** Latch operates by knob or lever from either side of door.
- **Privacy:** Push pin provided for privacy inside room. Emergency release hole for outside room. Emergency release key also provided.
- **Single Dummy:** Trim on one side of door only. Available for surface mounting. Knob or lever with rose.
- **Pair Dummy:** Trim on both sides of door. Knob or lever with thru-bolted or concealed screw rose set.

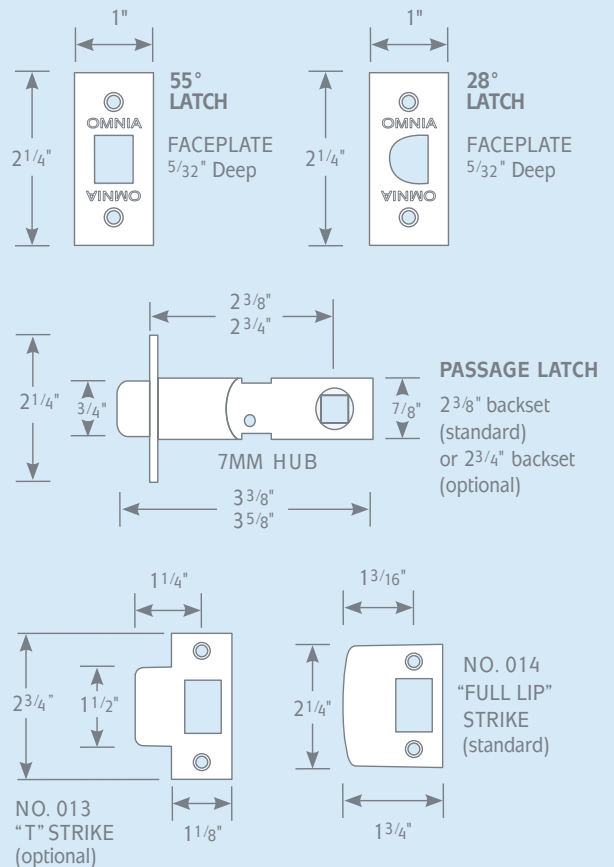

How to Order

PRODIGY options are shown below. To create your custom part number, make your selection from each column and enter its code number/letters on the line below it.



A - Design	B - Rose Option	C - Latch	D - Strike	E - Function	F - Finish
785	TD Traditional - 673 2 5/8" Dia.	2 3/8" Backset (Standard) 238	Full Lip (Standard) F - 014	PA PASSAGE - Latch operates by knob or lever from either side of the door	3 Polished Brass, Lacquered
895					3A Polished Brass, Unlacquered*
912	MD Modern - 679 2 5/8" Dia.	2 3/4" Backset (Optional) 234	(Optional) T - 013	PR PRIVACY - For bathroom or bedroom. Latch operates by knob or lever from either side of the door. Spindle locked by privacy block mechanism on inside rose; emergency release on outside rose.	4 Satin Brass, Lacquered
925					5 Antique Brass, Lacquered
930	AR Arched - 674 2 5/8" W x 3 1/4" H	2 3/4" Backset (Optional) 234	(Optional) T - 013	PD PAIR DUMMY - Trim on both sides of door. Knob or lever with thru-bolting or concealed screw rose set.	10B Oil-Rubbed Bronze, Lacquered
434					14 Polished Nickel Plated, Lacquered
458	RT Rectangular - 675 2 5/8" W x 3" H	2 3/4" Backset (Optional) 234	(Optional) T - 013	SD SINGLE DUMMY - Trim on one side of door only. Available for surface mounting or thru-bolting. Knob or lever with rose.	15 Satin Nickel Plated, Lacquered
565					26 Polished Chrome Plated
935	SQ Square - 678 2 9/16" Sq.	2 3/4" Backset (Optional) 234	(Optional) T - 013	NOTE: Thru-bolting dummy applications are recommended for commercial use.	26D Satin Chrome Plated**
566					TB Tuscan Bronze, Lacquered
936	SQ Square - 678 2 9/16" Sq.	2 3/4" Backset (Optional) 234	(Optional) T - 013	NOTE: Thru-bolting dummy applications are recommended for commercial use.	*3A Only available for 434, 458, 565 & 955 with Traditional rose.
955					**26D Only available for 912, 925, 930 & 935 with Modern, Rectangular or Square rose.
956					

EXAMPLE 895 AR / X 238 F PA 15
 A B (For Levers Only) C D E F

Example product order number would be **895AR/238F.PA15**

When ordering a 28° latch, please add "X" before the backset. (Example: 895AR/X238F.PA15)

Pricing

PA/PR = Passage/Privacy / Latch operates by knob or lever from either side of door.
PD = Pair Dummy / Trim on both sides of door.
SD = Single Dummy / Trim on one side of door only.

Pricing shown is suggested retail.

TIER 1

	Price	Lever	Knob
PA/PR	\$135	28° Latch	55° Latch
PD	\$130		
SD	\$65	785	434
		895	458
			565

Any Rose.
Any Finish.

TIER 2

	Price	Knob
PA/PR	\$145	55° Latch
PD	\$140	
SD	\$70	566
		936
		955
		956

Any Rose.
Any Finish.

TIER 3

	Price	Lever	Knob
PA/PR	\$155	28° Latch	55° Latch
PD	\$150		
SD	\$75	912	935
		925	
		930	

Any Rose.
Any Finish.

785



TD

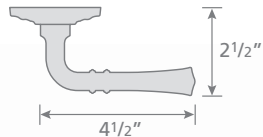

MD



AR



RT



SQ

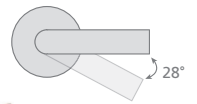

- US3
- US4
- US10B
- US14
- US15
- US26
- TB

28° Latch. Any Rose. Any Finish.

PA/PR \$135 PD \$130
SD \$65

895

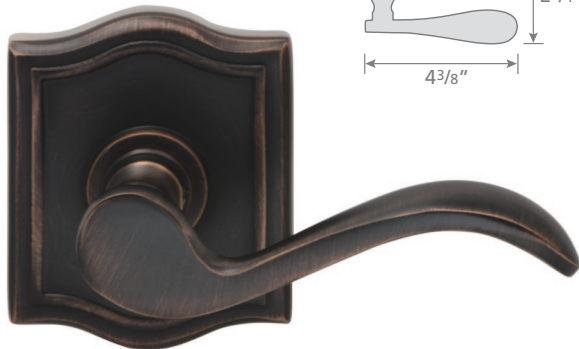

AR

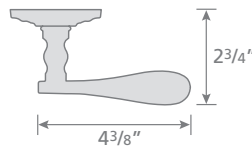

MD



TD



RT



SQ

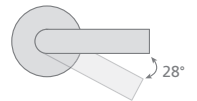

- US3
- US4
- US10B
- US14
- US15
- US26
- TB

28° Latch. Any Rose. Any Finish.

PA/PR \$135 PD \$130
SD \$65

434



RT



MD



AR



TD



SQ

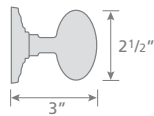

STANDARD: 55° Latch. Any Rose. Any Finish.
PA/PR \$135 PD \$130 SD \$65

OPTION: 28° Latch. Any Rose. Any Finish.
PA/PR \$155 PD \$150 SD \$75

- US3
- US3A*
- US4
- US10B
- US14
- US15
- US26
- TB

**US3A only available for TD rose.*

458



TD



MD



AR



RT



SQ

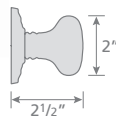

STANDARD: 55° Latch. Any Rose. Any Finish.
PA/PR \$135 PD \$130 SD \$65

OPTION: 28° Latch. Any Rose. Any Finish.
PA/PR \$155 PD \$150 SD \$75

- US3
- US3A*
- US4
- US10B
- US14
- US15
- US26
- TB

**US3A only available for TD rose.*

565



AR



MD



TD



RT



SQ

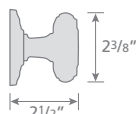

STANDARD: 55° Latch. Any Rose. Any Finish.
PA/PR \$135 PD \$130 SD \$65

OPTION: 28° Latch. Any Rose. Any Finish.
PA/PR \$155 PD \$150 SD \$75

- US3
- US3A*
- US4
- US10B
- US14
- US15
- US26
- TB

**US3A only available for TD rose.*

Matching glass cabinet hardware is available. See page 11.

566

US3
US4
US5
US10B
US14
US15
US26

STANDARD: 55° Latch. Any Rose. Any Finish.
 PA/PR **\$145** PD **\$140**
 SD **\$70**

OPTION: 28° Latch. Any Rose. Any Finish.
 PA/PR **\$165** PD **\$160**
 SD **\$80**

936

US3
US4
US5
US10B
US14
US15
US26

STANDARD: 55° Latch. Any Rose. Any Finish.
 PA/PR **\$145** PD **\$140**
 SD **\$70**

OPTION: 28° Latch. Any Rose. Any Finish.
 PA/PR **\$165** PD **\$160**
 SD **\$80**

955

US3
US3A*
US4
US5
US10B
US14
US15
US26
TB

STANDARD: 55° Latch. Any Rose. Any Finish.
 PA/PR **\$145** PD **\$140**
 SD **\$70**

OPTION: 28° Latch. Any Rose. Any Finish.
 PA/PR **\$165** PD **\$160**
 SD **\$80**

*US3A only available for TD rose.

956

US3
US4
US5
US10B
US14
US15
US26

STANDARD: 55° Latch. Any Rose. Any Finish.
 PA/PR **\$145** PD **\$140**
 SD **\$70**

OPTION: 28° Latch. Any Rose. Any Finish.
 PA/PR **\$165** PD **\$160**
 SD **\$80**

ROSE DESIGN: **TD** = Traditional / **MD** = Modern / **AR** = Arched / **RT** = Rectangular / **SQ** = Square
 All roses are concealed screw mounted. • See page 3 for enlarged images of all finishes.

912

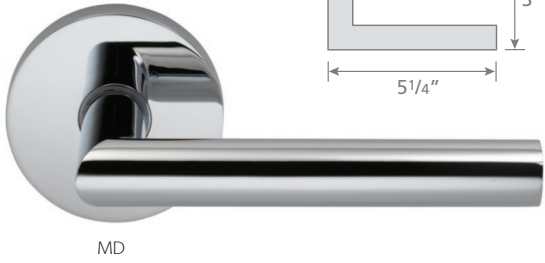

- US3
- US4
- US10B
- US14
- US15
- US26
- US26D
- TB

28° Latch. Any Rose. Any Finish.
 PA/PR \$155 PD \$150 SD \$75

925

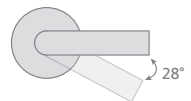
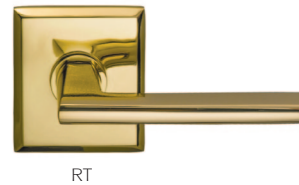
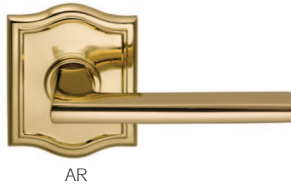
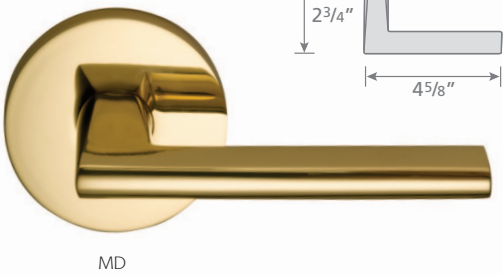

- US3
- US4
- US10B
- US14
- US15
- US26
- US26D
- TB

28° Latch. Any Rose. Any Finish.
 PA/PR \$155 PD \$150 SD \$75

930

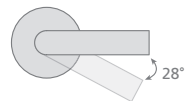
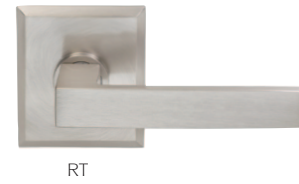
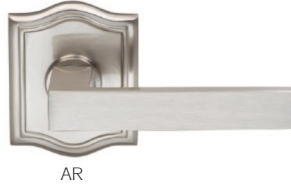
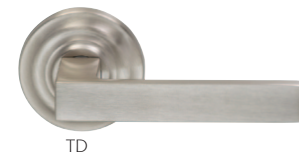
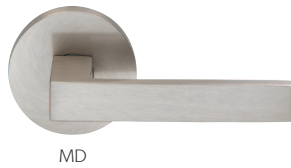
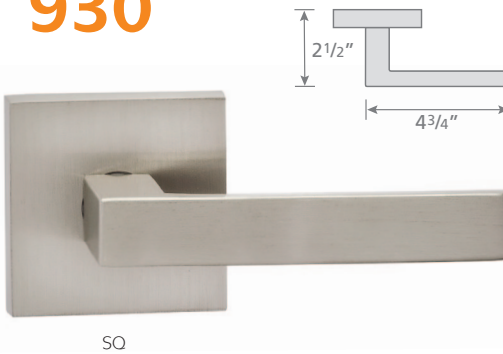

- US3
- US4
- US10B
- US14
- US15
- US26
- US26D
- TB

28° Latch. Any Rose. Any Finish.
 PA/PR \$155 PD \$150 SD \$75

935



- US3
- US4
- US10B
- US14
- US15
- US26
- US26D*
- TB

STANDARD: 55° Latch. Any Rose. Any Finish. PA/PR \$155 PD \$150 SD \$75
 OPTION: 28° Latch. Any Rose. Any Finish. PA/PR \$175 PD \$170 SD \$85

*US26D only available for MD, RT & SQ roses.

Auxiliary Deadbolt Kits

ALL KITS: Door Thickness: (Min) 1 3/8" (Max) 3"
Cylinders provided with Schlage C keyway.

These kits are used with a door that needs to be locked with a key. This locking function can be used where security is required and features a keyed cylinder on the exterior and a turnpiece on the interior side of the door.



Traditional TRADDB

\$135
Any Finish.

- Finishes: **US3, US4, US10B, US14, US15, US26, TB**
- 2 5/8" Diameter
 - 9/16" Exterior Projection
 - 1 3/8" Interior Turnpiece Projection

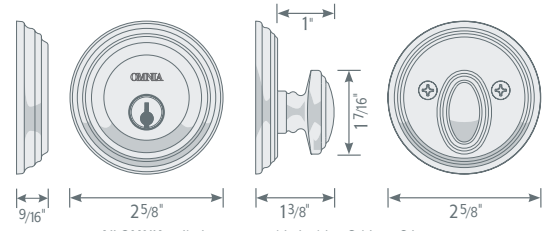

Rectangular RECTDB

\$135
Any Finish.

- Finishes: **US3, US4, US10B, US14, US15, US26, US26D, TB**
- 2 5/8" Square
 - 5/8" Exterior Projection
 - 1 3/8" Interior Turnpiece Projection

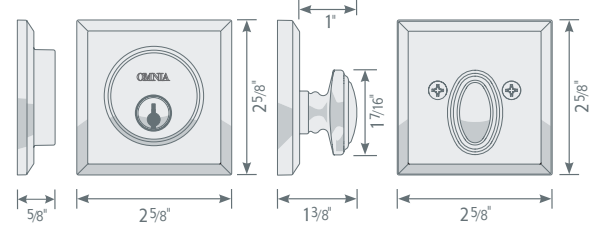

Arched ARCHDB

\$135
Any Finish.

- Finishes: **US3, US4, US10B, US14, US15, US26, TB**
- 2 3/4" H x 2 5/8" W
 - 5/8" Exterior Projection
 - 1 3/8" Interior Turnpiece Projection

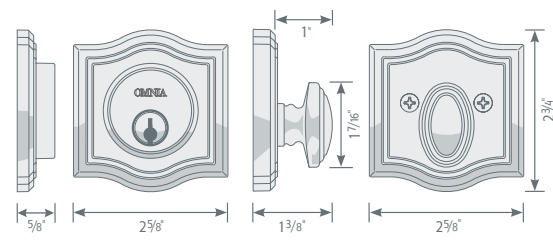

Modern MODDB

\$135
Any Finish.

- Finishes: **US3, US4, US10B, US14, US15, US26, US26D, TB**
- 2 5/8" Diameter
 - 9/16" Exterior Projection
 - 1 3/8" Interior Turnpiece Projection

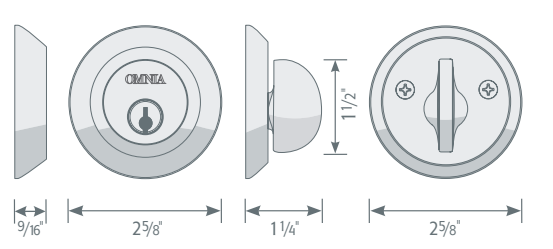

Square SORDB

\$135
Any Finish.

- Finishes: **US3, US4, US10B, US14, US15, US26, US26D**
- 2 5/8" Square
 - 5/8" Exterior Projection
 - 1 3/8" Interior Turnpiece Projection

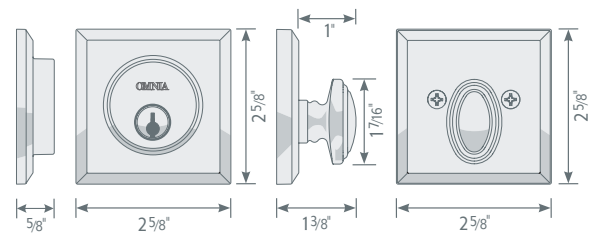

Colonial COLDB

\$135
Any Finish.

- Finishes: **US3, US3A, US4, US5, US5A, US10B, US14, US15, US26, SB, TB**
- 2 1/2" Diameter
 - 9/16" Exterior Projection
 - 1 3/16" Interior Turnpiece Projection

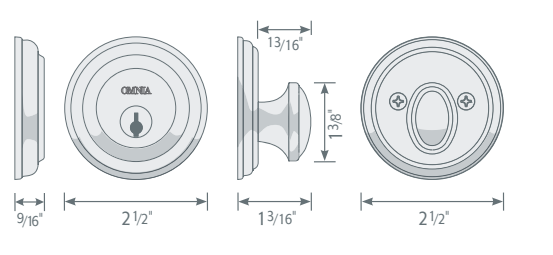

Glass Cabinet Hardware

See page 3 for enlarged images of all finishes.

9566



- US3
- US4
- US5
- US10B
- US14
- US15
- US26

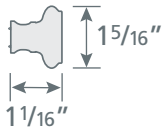

\$20.50

9936



- US3
- US4
- US5
- US10B
- US14
- US15
- US26

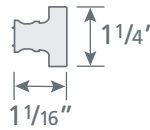

\$20.50

9955



- US3
- US4
- US5
- US10B
- US14
- US15
- US26

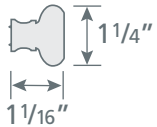

\$20.50

9956



- US3
- US4
- US5
- US10B
- US14
- US15
- US26

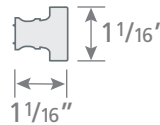

\$20.50

Hinges

Please refer to our complete Hinge Catalog for all hinge sizes and finishes.



985BB/4



985/35



985R/35



Finial Options



Since 1964, the OMNIA name has been synonymous with architectural hardware that is uniquely and stylishly designed while exceptionally functional. OMNIA prides itself on our attention given to every element, from quality to innovation, from service to marketing. A blending of traditions of excellence, coupled with a strong commitment to modern technologies, makes OMNIA your sound choice for any residential or commercial application.

Prodigy
FORGING ELEGANCE
OMNIA

OMNIA
INDUSTRIES, INC.

5 Cliffside Drive • Box 330
Cedar Grove, New Jersey 07009
tel 973.239.7272 / fax 973.239.5960
order desk fax 800.542.7611
www.OMNIAindustries.com

