

24 BAKER ST. P.O. BOX 100, HASTINGS ON KOL - 1Y0
 705-696-2385, 1-800-465-3433, FAX: 705-696-1922

14' X 28' OCTAGONAL

QTY.	LENGTH	RADIUS	TYPE
1	8'0"	NA	SKIMMER
3	8'0"	NA	PLAIN
2	7'0"	NA	RETURN
4	7'0"	NA	PLAIN
4	-	NA	30° OUTSIDE CORNER
4	-	NA	60° OUTSIDE CORNER
2	-	NA	A-FRAME
1	-	NA	N&B PKG
			S.A. 351 sq.ft.
			PER: 74'
14280CTC			DATE: 15-11-00

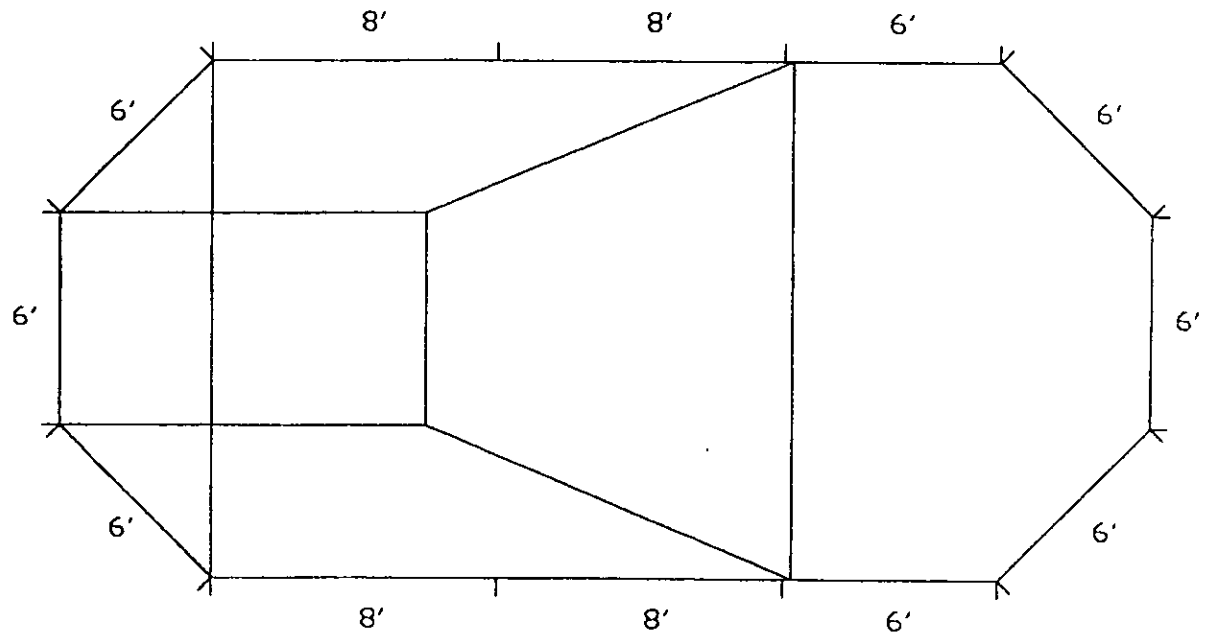

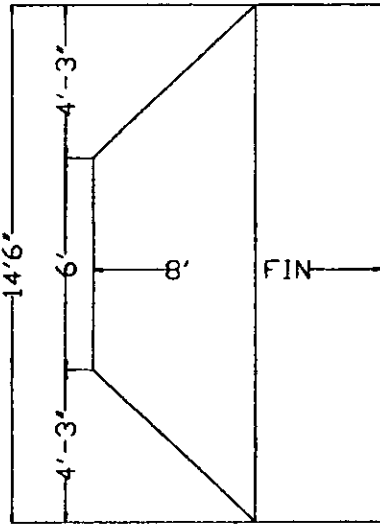

24 BAKER ST. P.O. BOX 100, HASTINGS DN. KOL-1Y0
 705-696-2385, 1-800-465-3433, FAX: 705-696-1922

15'X30' OCTAGONAL

QTY.	LENGTH	RADIUS	TYPE
2	8'0"	NA	RETURN
1	8'0"	NA	SKINNER
1	8'0"	NA	PLAIN
8	6'0"	NA	PLAIN
8	-	NA	45° OUTSIDE CORNER
4	-	NA	A-FRAME
1	-	NA	N&B PKG
			S.A.: 406 sq.ft.
			PER: 80'
15300CTC			DATE: 15-11-00

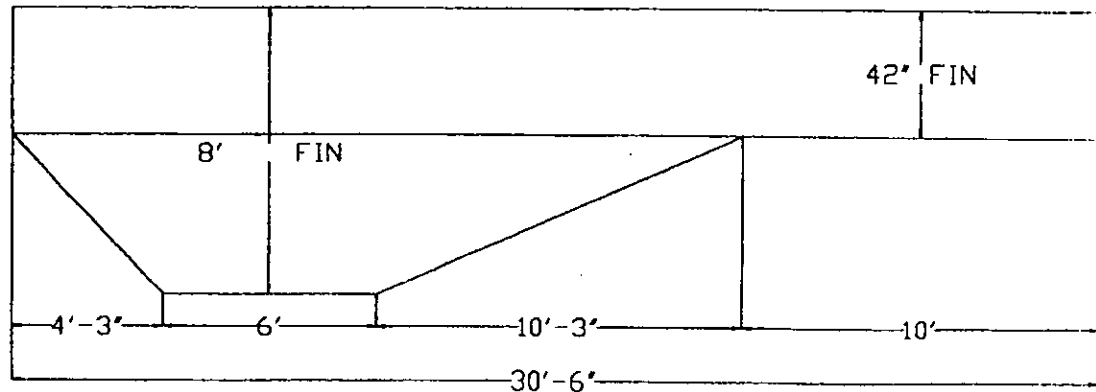

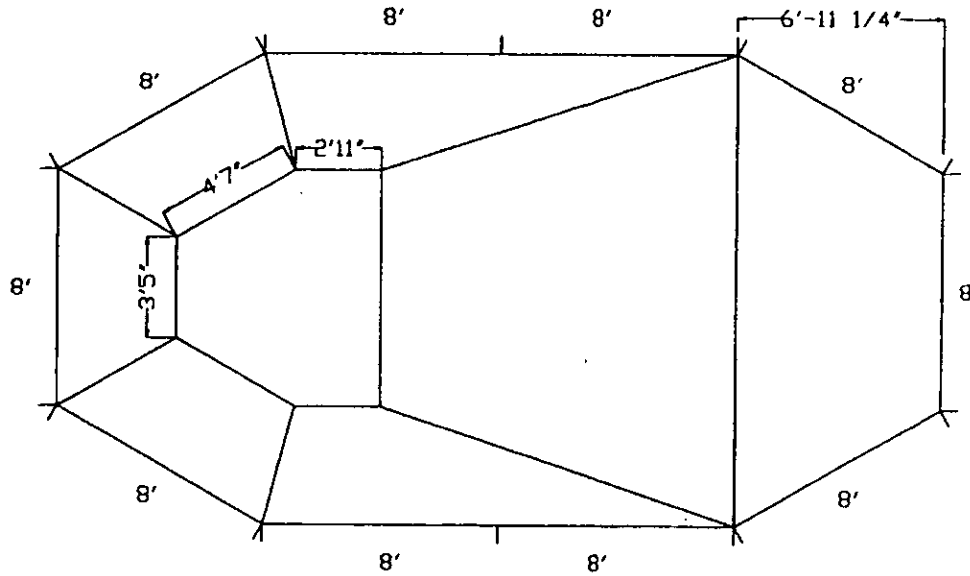
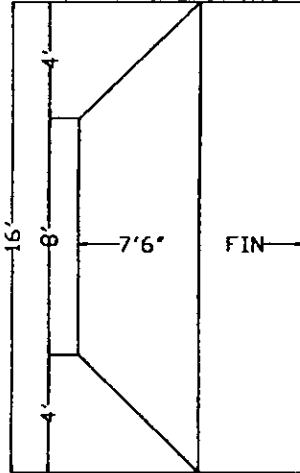

24 BAKER ST. P.O. BOX 100, HASTINGS ON KOL-1YO
 705-696-2385, 1-800-465-3433, FAX: 705-696-1922

16'X30' OCTAGONAL

QTY.	LENGTH	RADIUS	TYPE
1	8'0"	NA	SKIMMER
2	8'0"	NA	RETURN
7	8'0"	NA	PLAIN
4	-	NA	30° OUTSIDE CORNER
4	-	NA	60° OUTSIDE CORNER
2	-	NA	A-FRAME
1	-	NA	N&B PKG
			S.A.: 422 sq.ft.
			PER: 80'
16300CTC			DATE: 15-11-00

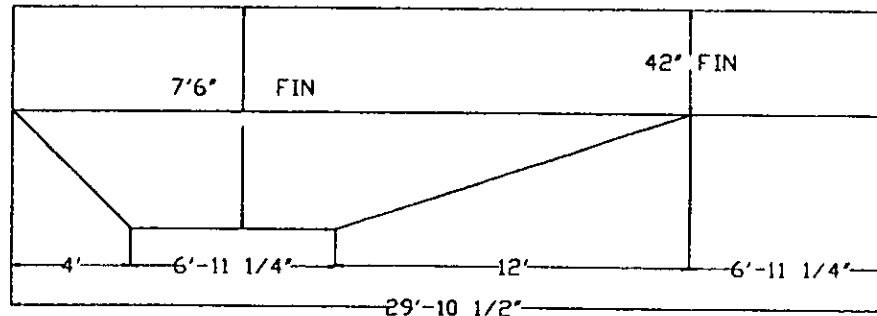

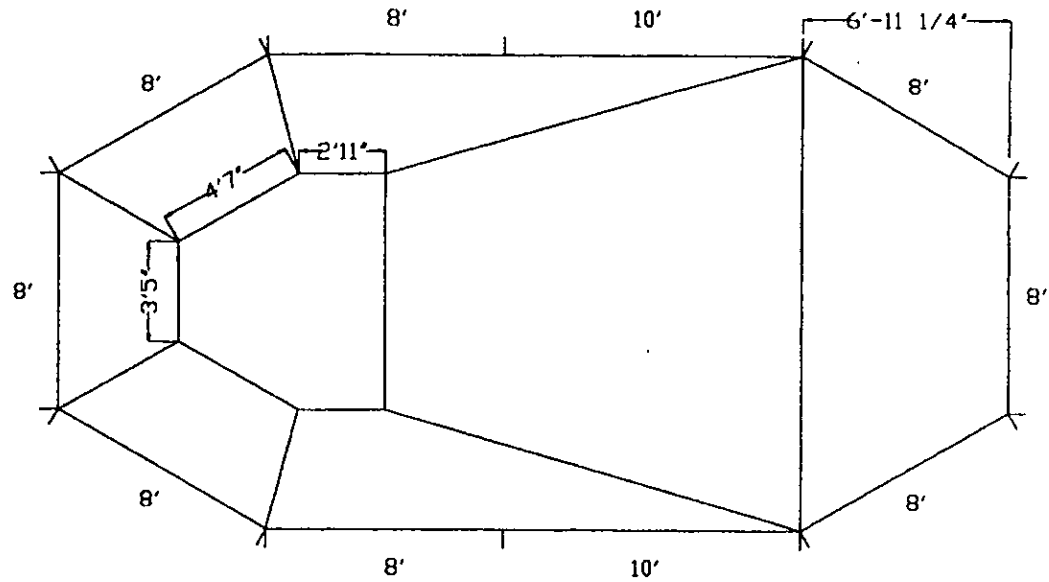
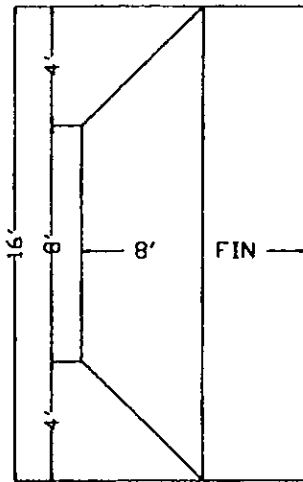

24 BAKER ST, P.O. BOX 100, HASTINGS DNKQL-1Y0
 705-696-2385, 1-800-465-3433, FAX: 705-696-1922

16'X32' OCTAGONAL

QTY.	LENGTH	RADIUS	TYPE
2	10'0"	NA	PLAIN
1	8'0"	NA	SKIMMER
2	8'0"	NA	RETURN
5	8'0"	NA	PLAIN
4	-	NA	30° OUTSIDE CORNER
4	-	NA	60° OUTSIDE CORNER
2	-	NA	A-FRAME
1	-	NA	N&B PKG
			S.A.: 454 sq.ft.
			PER: 84'
1632DCTC			DATE: 15-11-00

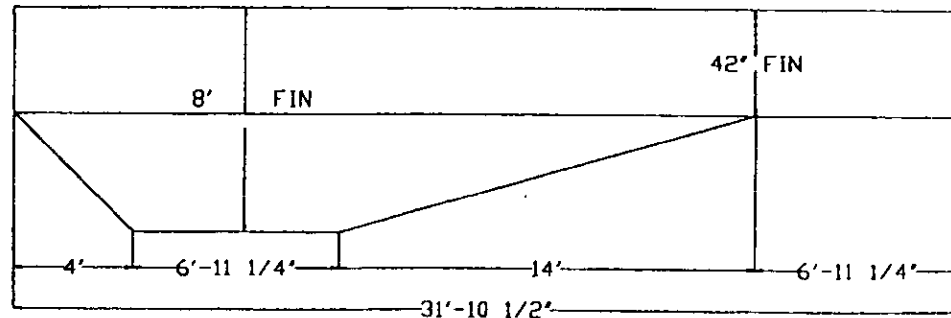

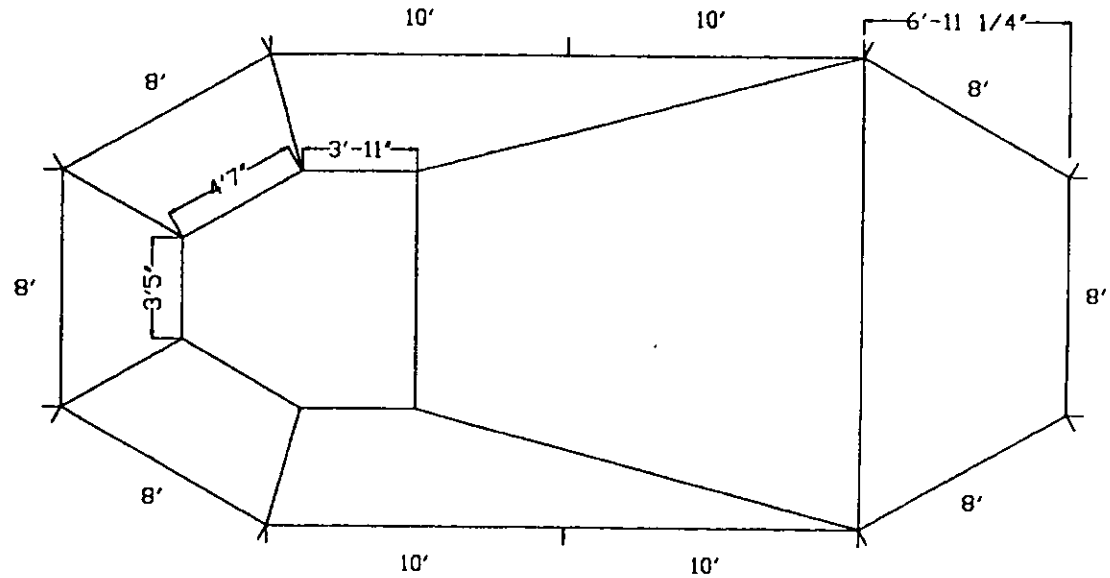
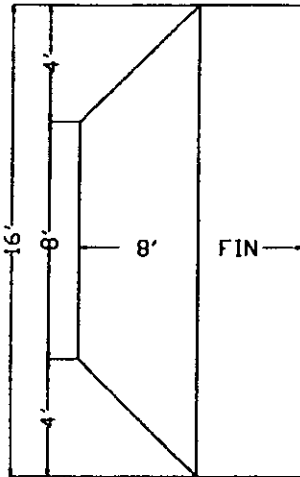

24 BAKER ST., P.O. BOX 100, HASTINGS ON KOL - 1Y0
 705-696-2383, 1-800-465-3433, FAX 705-696-1922

16' X 34' OCTAGONAL

QTY.	LENGTH	RADIUS	TYPE
3	10'	NA	PLAIN
1	10'	NA	SKIMMER
2	8'0"	NA	RETURN
4	8'0"	NA	PLAIN
4	-	NA	30° OUTSIDE CORNER
4	-	NA	60° OUTSIDE CORNER
2	-	NA	A-FRAME
1	-	NA	N&B PKG
			S.A.: 486 sq.Ft
			PER: 88'
16340CTC			DATE: 16-11-00

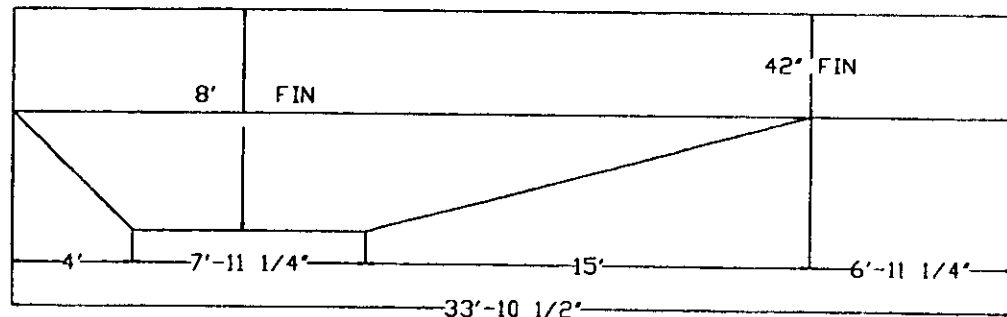

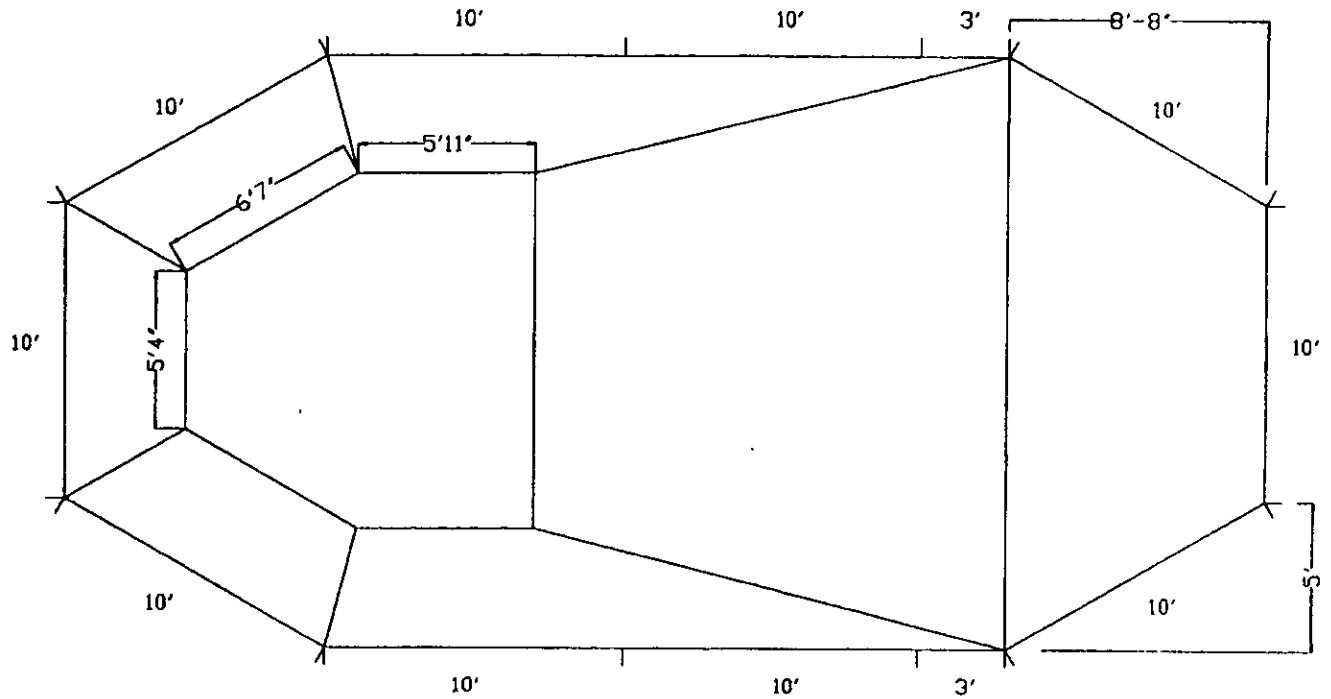
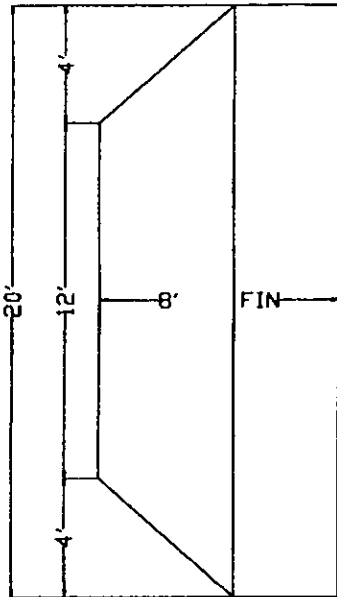

24 BAKER ST, P.O. BOX 100, HASTINGS ON KOL - 1Y0
 705-696-2385, 1-800-465-3433, FAX: 705-696-1922

20' X 40' OCTAGONAL

QTY.	LENGTH	RADIUS	TYPE
1	10'0"	NA	SKIMMER
2	10'0"	NA	RETURN
7	10'0"	NA	PLAIN
2	3'0"	NA	PLAIN
4	-	NA	30° OUTSIDE CORNER
4	-	NA	60° OUTSIDE CORNER
4	-	NA	A-FRAME
1	-	NA	N&B PKG
			S.A. 720 sq.ft.
			PER: 106'
20400CTC			DATE: 16-11-00

