

LIRT

LED INSET THRESHOLD LIGHT



COMPLIANCES

ICAO: Annex 14 - Volume I Fig. A2-3
FAA: L-850E(L) AC150/5345-46 and EB No.67
IEC: TS 61827
NATO: STANAG 3316
CAA: CAP 168
IAAE: TP312

APPLICATIONS

Threshold for ICAO CAT I, II and III, FAA and military runways

BENEFITS

- 60000 hours LED rated life at full intensity, but over 100000 hours in field operating conditions
- In new installation, LED lights mean lower loads, lower size of CCRs and transformers, thus low life cycle costs
- The light output is variable like a traditional halogen lamp, as indicated by the FAA "Engineering Briefing No.67"
- Colour emitted directly by LEDs: absence of coloured filters ensures no energy losses and no colour shifts
- Fully compatible with existing AFL infrastructure*
- Designed with simplicity allowing longer maintenance intervals and fewer spare parts
- No use of sealant to fix the prisms in the dome thanks to customized gaskets, making their replacement quick and easy
- No optical adjustment after LED module or prism replacement
- Valve for watertightness test after overhaul
- Operating with any topology of CCRs designed in compliance with IEC or FAA requirements

* For monitored fixtures, isolation transformer max size: 200VA

PERFORMANCES

- The electronic is strong-built and highly resistant to shock and vibration
- Automatic adaptation to the frequency of the supply current
- A surge protection device is provided in the electronics as required by the FAA "Engineering Briefing No.67"
- Immediate detection of an internal fault
- 6.35 mm protrusion strongly reduces vibrations to aircrafts and to light itself, increasing its lifetime
- Dome smooth outer profile makes the light less sensitive to snowplough blades
- Unidirectional, 12" dia.
- Drop-forged dome and cast aluminium lower cover make the fitting sturdy, but lightweight too for ease handling in the field
- Light output practically not affected by heavy rainfall thanks to the shallow channel in front of the prism windows
- O-Ring placed outside the dome to avoid dirt deposits between light and base
- Protection degree: IP67
- Temperature range: -55°C to +55°C

INSTALLATION

- Suitable for 12" dia. bases
- Specific tools available for easy and precise installation

PHOTOMETRIC PERFORMANCES

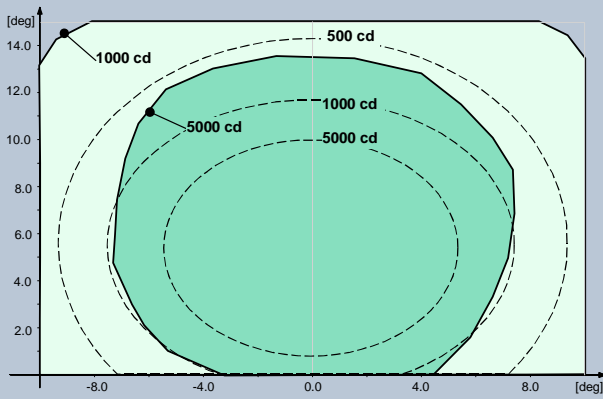

Fig. 1 ICAO A2-3 – Green

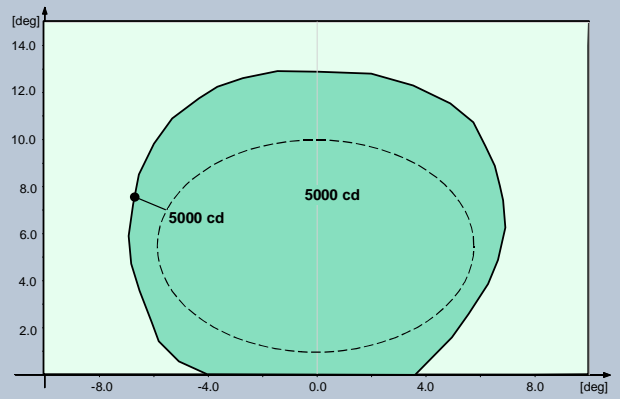
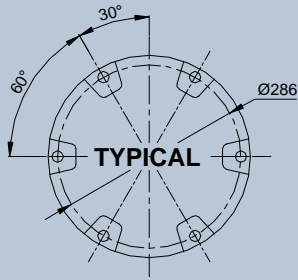

Fig. 2 FAA L-850E – Green

TABLES

POWER CONSUMPTION*	
Electrical System	1 Plug
Unidirectional (w/o Arctic Kit)	36 VA
Unidirectional (with Arctic Kit)	76 VA
* Measured at 6.6 A and referred to the highest consumption configuration	

POWER FACTOR		
Input Step	2.8 A	6.6 A
Power Factor	0.96	0.98



Light Fixture 12" dia.

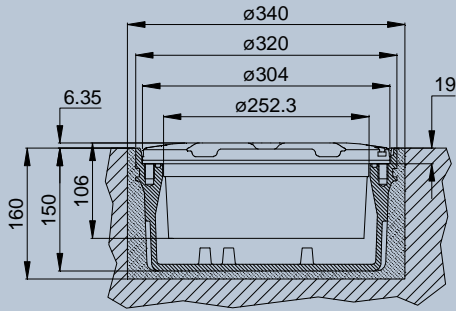

Shallow Base 12" dia.

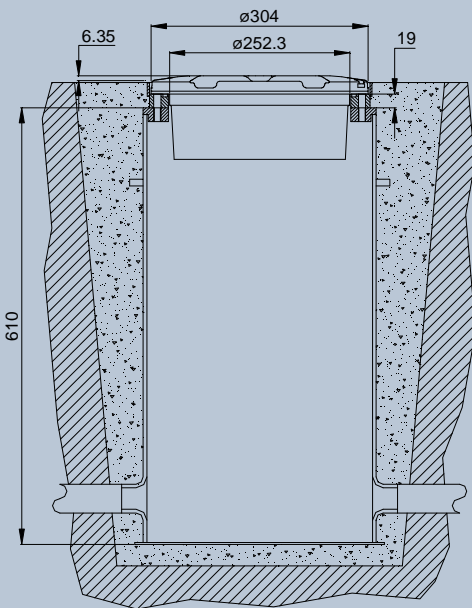

L-868 Deep Base 12" dia.

LIRT- F - L - M - A

Basic P/N: _____

Compliance*: _____

F = FAA

I = ICAO

Toe-in:** _____

R = Left

L = Right

S = Straight

Monitoring: _____

O = Without Monitoring

M = With Monitoring

Arctic Kit: _____

O = Without Arctic Kit

A = With Arctic Kit

* Compliance "F" must be combined with Toe-in "S" only

** The beam aiming is not field adjustable

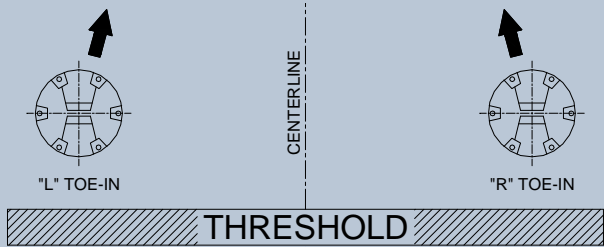

RENEWAL PARTS FOR LIGHT UNIT

- 1 Dome with prisms and gaskets
- 2 O-Ring for dome (external)
- 3 O-Ring for dome (internal)
- 4 O-Ring for lower cover
- 5 Arctic Kit heater
- 6 Reflector with hardware
- 7 LED module with accessories
- 8 Lower cover with electronic, plug and valve
- 9 Valve for watertightness test
- 10 FAA L-823 plug
- 11 Arctic Kit thermostat
- 12 Prism Gasket
- 13 Prism
- 14 Prism holder gasket
- 15 Mounting plate

Refer to the relevant technical manual for the complete list of the available spare parts

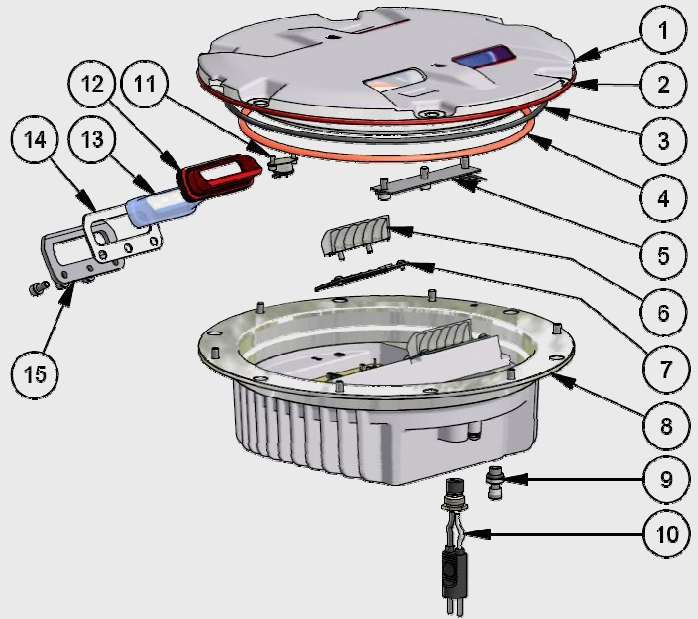

ACCESSORIES

- 315.1230 Base L-868 type, class IA, size B, 24" deep *
- 315.1420 Flange ring with pavement dam for L-868 base, size B, with O-Ring and bolts
- 152.8110 Shallow base, 12" dia., one cable lead, with gasket and hardware
- 712.1012 Setting material for shallow base, 5 l
- 712.1013 Setting material for shallow base, 20 l
- 332.4301 Positioning jig for 8"-12" dia. shallow base, without optical device
- 332.4351 Optical device for positioning jig to allow a very precise light unit orientation
- 332.4330 Watertight/shockproof plastic case complete with positioning jig for base and optical device
- 332.4140 Lifting tool (2 pieces to work properly)

* Sectional bases may be required depending upon the paving technique

For any information about isolating transformers and connectors, please see the specific catalogue pages

Shipping Weights and Volumes

	Light Unit	Shallow Base
Weight (kg)	7.3	7.3
Volume (m ³)	0.022	0.022

We reserve the right to change the design or specification data without notice