





## Operating instructions

### Digital tank contents indicator DTA 10

DTA 10 0 – 4.0 m fuel oil

DTA 10 0 – 3.5 m water

-  Read instructions before using device!
-  Observe all safety information!
-  Keep instructions for future use!



# Table of contents

1	This instruction manual.....	4
1.1	Precautions .....	4
1.2	Explanation of symbols and typeface .....	4
2	Safety .....	5
2.1	Intended use .....	5
2.2	Predictable incorrect application .....	5
2.3	Safe handling .....	5
2.4	Staff qualification.....	6
2.5	Modifications to the product.....	6
2.6	Usage of spare parts and accessories.....	6
2.7	Liability information .....	6
3	Product description.....	7
3.1	Scope of delivery.....	7
3.2	Properties .....	8
3.3	Application example .....	8
3.4	Measuring instrument.....	9
3.5	Overview of the menu structure .....	10
4	Technical specifications.....	11
4.1	Approvals, tests and conformities .....	11
5	Transport and storage .....	12
6	Mounting.....	12
6.1	Preparing mounting.....	12
6.2	Mounting the measuring instrument.....	13
6.3	Electrical connection .....	14
6.4	Mounting the measuring line to the tank.....	15
6.5	Mounting the measuring line to the measuring instrument.....	17
7	Adjusting the measuring instrument .....	18
7.1	Adjusting the language.....	18
7.2	Adjusting the medium.....	18
7.3	Setting the tank shape .....	19
7.4	Adjusting the tank height.....	19
7.5	Adjusting the tank volume .....	19
7.6	Adjusting the alarm .....	19
8	Operation.....	20
8.1	Starting a measurement.....	20
8.2	Battery status/software indication .....	21
8.3	Switching off the measuring instrument .....	22

9	Troubleshooting .....	23
10	Decommissioning, disposal .....	23
11	Spare parts and accessories .....	24
12	Warranty .....	24
13	Copyright .....	24
14	Customer satisfaction .....	24
15	Addresses .....	24



# 1 This instruction manual

This instruction manual is part of the product.

- ▶ Read this manual before using the product.
- ▶ Keep this manual during the entire service life of the product and always have it readily available for reference.
- ▶ Always hand this manual over to future owners or users of the product.

## 1.1 Precautions

**WARNING TERM**Type and source of the danger are shown here.



- ▶ Precautions to take in order to avoid the danger are shown here.

There are three different levels of warnings:

Warning term	Meaning
<b>DANGER</b>	Immediately imminent danger! Failure to observe the information will result in death or severe injuries.
<b>WARNING</b>	Possibly imminent danger! Failure to observe the information may result in death or severe injuries.
<b>CAUTION</b>	Dangerous situation! Failure to observe the information may result in minor or severe injuries as well as damage to property.

## 1.2 Explanation of symbols and typeface

Symbol	Meaning
<input checked="" type="checkbox"/>	Prerequisite for an activity
▶	Activity consisting of a single step
1.	Activity consisting of a several steps
↪	Result of an activity
•	Bulleted list
Text	Indication on display
<b>Highlighting</b>	Highlighting



## 2 Safety

### 2.1 Intended use

The digital tank contents indicator DTA 10 is suitable for level measurement of the following liquids:

- Fuel oil (density 0.84 g/cm<sup>3</sup>)
- Water (density 1 g/cm<sup>3</sup>)
- Variable (density adjustable from 0.5 – 1.5 g/cm<sup>3</sup>)  
No corrosive liquids may be used.

Any use other than the application explicitly permitted in this instruction manual is not permitted.

### 2.2 Predictable incorrect application

The digital tank contents indicator DTA 10 must never be used in the following cases:

- Hazardous area (Ex)  
If the device is operated in hazardous areas, sparks may cause deflagrations, fires or explosions.
- Use as safety equipment  
The digital tank contents indicator DTA 10 does **not** replace the function of a level sensor at the fuel oil tank.
- Use as overfill prevention system
- Use for billing purposes (DTA 10 is **not** officially calibrated)

### 2.3 Safe handling

This product represents state-of-the-art technology and is made according to the pertinent safety regulations. Each product is subjected to a function and safety test prior to shipping.

- ▶ Operate the product only when it is in perfect condition. Always observe the operating instructions, all pertinent local and national directives and guidelines as well as the applicable safety regulations and directives concerning the prevention of accidents.

Extreme environmental conditions have negative effects on the function of the product.

- ▶ Protect the digital tank contents indicator DTA 10 from shocks.
- ▶ Only use the measuring instrument in rooms.
- ▶ Protect the measuring instrument from humidity.



## 2.4 Staff qualification

The product may only be mounted, commissioned, operated, maintained, decommissioned and disposed of by qualified, specially trained staff.

Electrical work may only be performed by trained electricians and in compliance with all applicable local and national directives.

## 2.5 Modifications to the product

Changes or modifications made to the product by unauthorised persons may lead to malfunctions and are prohibited for safety reasons.

## 2.6 Usage of spare parts and accessories

Usage of unsuitable spare parts and accessories may cause damage to the product.

- ▶ Use only genuine spare parts and accessories of the manufacturer (see chapter 11, page 24).

## 2.7 Liability information

The manufacturer shall not be liable in any form whatsoever for direct or consequential damage resulting from failure to observe the technical instructions, guidelines and recommendations.

The manufacturer or the sales company shall not be liable for costs or damages incurred by the user or by third parties in the usage or application of this product, in particular in case of improper use of the product, misuse or malfunction of the connection, malfunction of the product or of connected products. The manufacturer or the sales company shall not be liable for damage whatsoever resulting from any use other than the use explicitly permitted in this instruction manual.

The manufacturer shall not be liable for misprints.



## 3 Product description

### 3.1 Scope of delivery

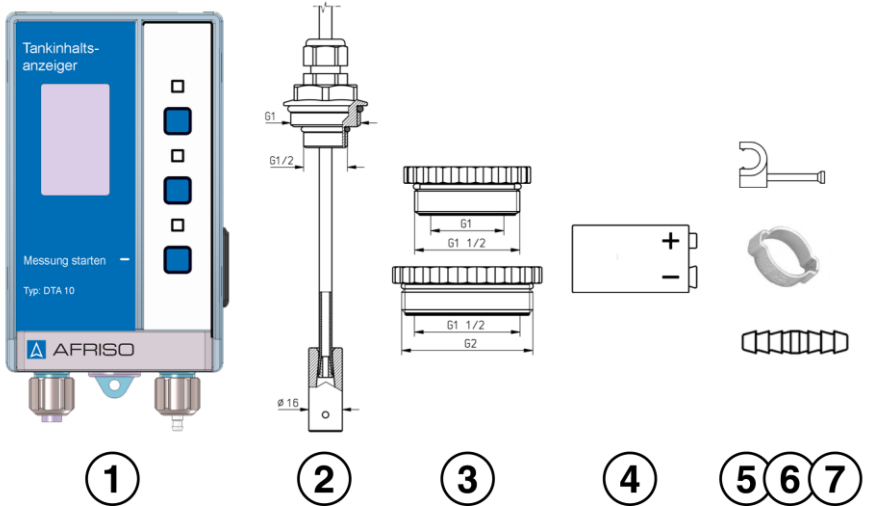

Fig. 1: Scope of delivery digital tank contents indicator DTA 10

- |   |   |   |   |
|---|---|---|---|
| 1 | Measuring instrument                      | 5 | Nail cable clips (25 pieces)  |
| 2 | Measuring line (20 m) with bottom part    | 6 | Hose clamps (2 pieces)  |
| 3 | Screw connector kit<br>G1½ x G1, G2 – G1½ | 7 | Hose adapter  |
| 4 | Monobloc battery 9 V                      |   | Bag of accessories (not shown) with 2 screws and 2 dowels for wall mounting |

### 3.2 Properties

The digital tank contents indicator DTA 10 consists of a measuring instrument with digital display.

The following information can be entered at the digital tank contents indicator DTA 10: medium (fuel oil, water and variable), the tank shape (linear, spherical and cylindrical horizontal), the tank height (in cm), the volume (in litres) and an alarm threshold (in percent).

If the device measures a value that is below an adjustable minimum level (adjustable in percent via the Alarm menu item), a visual alarm is triggered (the display changes/flashes).

---

**INFO**

**If the geometry of the tank differs from the geometries mentioned above (for example, battery tank), the information must be taken from the bearing chart of the tank manufacturer).**

---

### 3.3 Application example

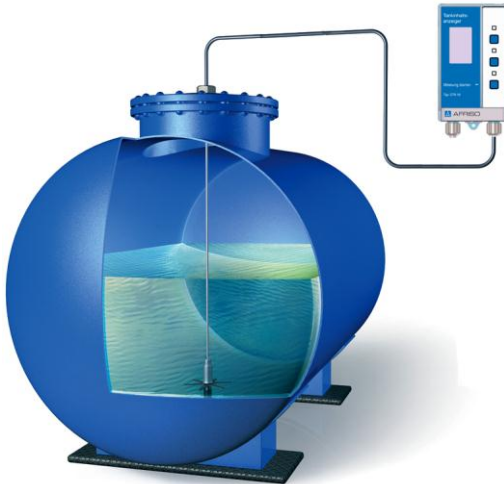

*Fig. 2: Application example digital tank contents indicator DTA 10*





### 3.4 Measuring instrument

The measuring instrument features an impact-resistant plastic housing.

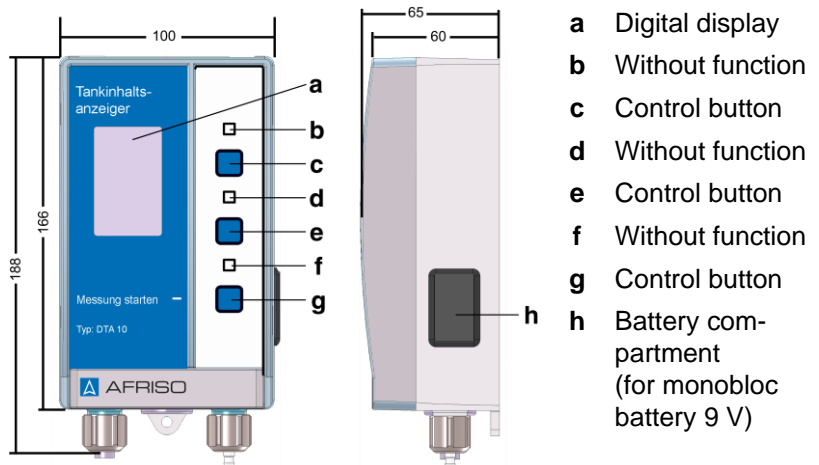

Fig. 3: Measuring instrument (dimensions in mm)



### 3.5 Overview of the menu structure

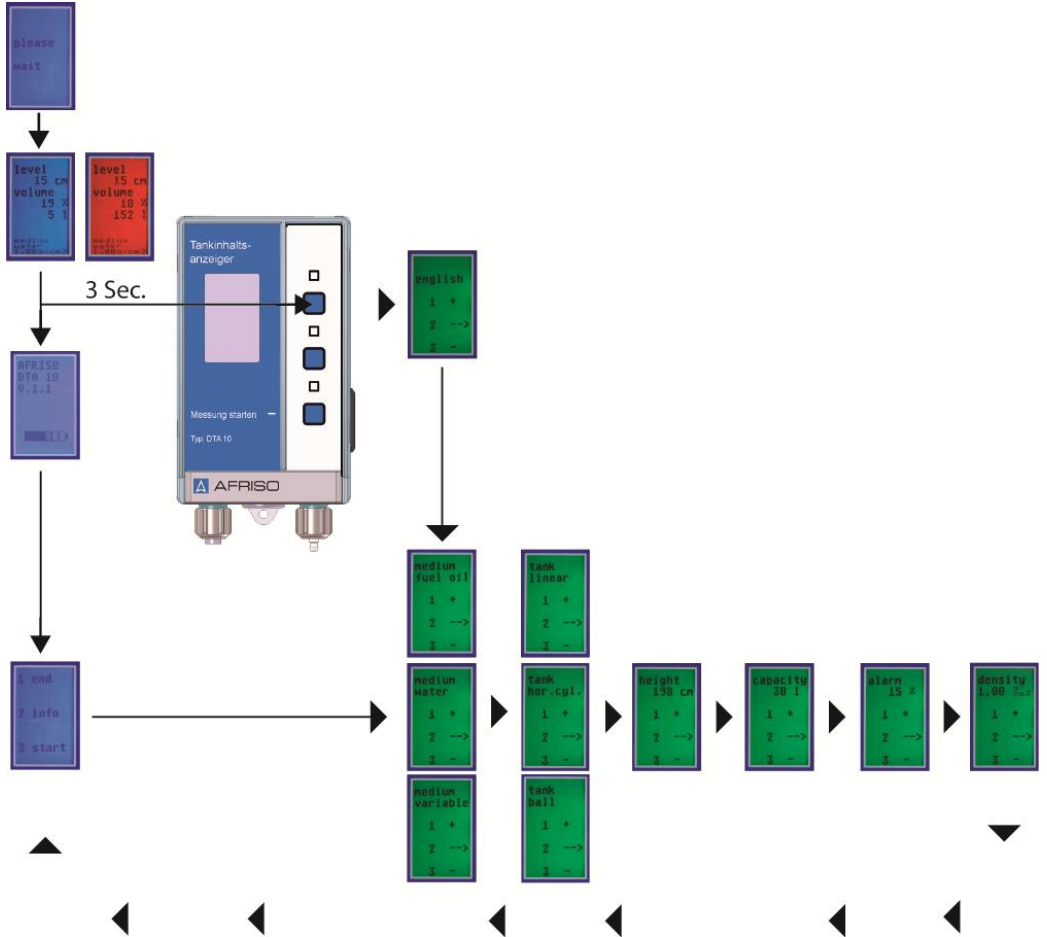

Fig. 4: Menu structure



## 4 Technical specifications

Table 1: Technical specifications

Parameters	Value
<b>General specifications</b>	
Dimensions housing (W x H x D)	100 x 188 x 65 mm
Measuring line	20 m
Housing material	Plastic, ABS
Accuracy	± 1.0 cm (liquid column)
<b>Operating temperature range</b>	
Ambient	0 °C to +50 °C
Storage	-20 °C to +65 °C
<b>Supply voltage</b>	
Nominal voltage	9 V monobloc battery
<b>Maximum tank height</b>	
Fuel oil	Max. 4.0 m
Water	Max. 3.5 m
<b>Electromagnetic compatibility (EMC)</b>	
Interference	As per EN 61000-6-3
Noise immunity	As per EN 61000-6-1

### 4.1 Approvals, tests and conformities

The digital tank contents indicator DTA 10 complies with the EMC Directive (2004/108/EC).



## 5 Transport and storage

---

**CAUTION****Damage to the product due to improper transport.**

- ▶ Do not throw or drop the product.

---

**CAUTION****Damage to the product due to improper storage.**

- ▶ Protect the product from shock when storing it.
- ▶ Store the product in a clean and dry environment.
- ▶ Only store the product within the permissible temperature range.

---

Do not operate products with visible damages.

## 6 Mounting

### 6.1 Preparing mounting

- ▶ Only use the measuring instrument in rooms.
- ▶ Protect the measuring instrument from humidity.
- ▶ Mount the measuring instrument to a plane, rigid and dry wall at eye level.
- ▶ Mount the measuring instrument in such a way that it is accessible and easy to oversee at all times.

---

**CAUTION****Damage to the measuring instrument**

- ▶ Never open the measuring instrument. To replace the battery, open the battery compartment located at the side of the measuring instrument.
-

## 6.2 Mounting the measuring instrument

1. Mount the measuring instrument to the wall.

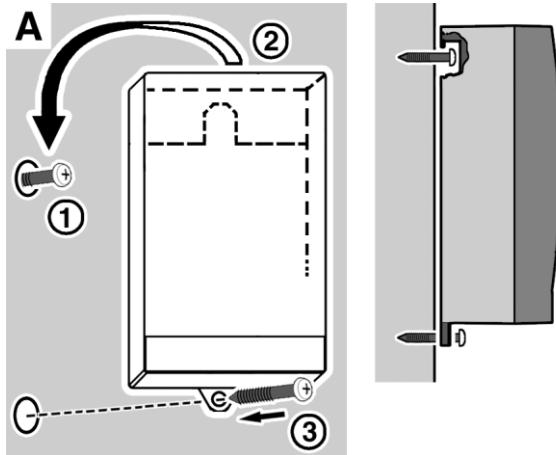

Fig. 5: Mounting the measuring instrument to the wall

- A**
- 1 Drill a hole ( $\varnothing$  5 mm) into the wall using a drill, insert the enclosed dowel and screw in the screw.
  - 2 Fit the measuring instrument.
  - 3 Mark a drilling hole at the position of the bottom lug, drill the hole ( $\varnothing$  5 mm) with a drill and insert the enclosed dowel. Fasten the measuring instrument by screwing the bottom lug to the wall.

## 6.3 Electrical connection

When the measuring instrument is delivered, the monobloc battery (9 V) is not installed (the battery is contained in the bag of accessories).

### Connecting and inserting the monobloc battery

1. Open the cover of the battery compartment using a slotted screwdriver.

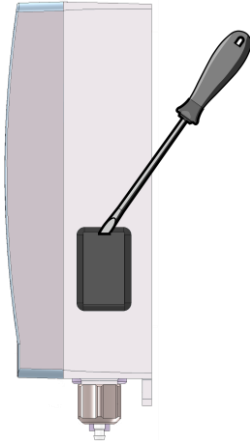

2. Connect the monobloc battery (9 V) and push the monobloc battery into the battery compartment as shown in the figure (ensure correct mounting position).

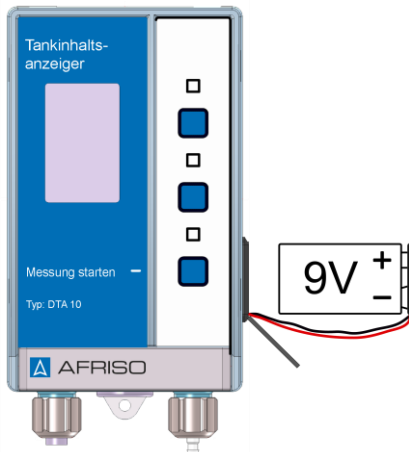

3. Close the cover of the battery compartment.

## 6.4 Mounting the measuring line to the tank

1. Select the threaded adapter (screw connector kit) suitable for the tank connection.

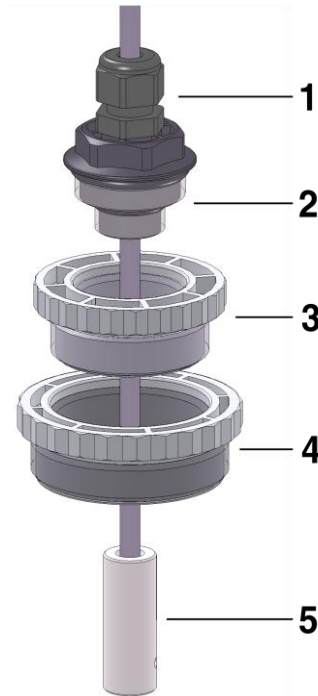

- 1 Screw connector for holding the measuring line.
- 2 Connection threads (G ½ and G1)
- 3 Threaded adapter (G1 to G1½)
- 4 Threaded adapter (G1½ to G2)
- 5 Bottom part

Fig. 6: Mounting to tank with screw connector kit

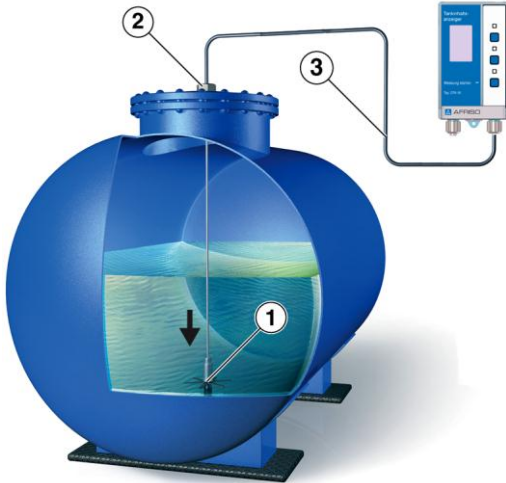

2. Lower the bottom part [1] to the bottom of the tank.
3. Tighten the screw connector [2] so that the measuring line can no longer be moved and that the connection is odour-tight.
4. Use the enclosed nail cable clips to fasten the measuring line [3].

---

**CAUTION**    **Damage to the measuring line**

- ▶ Never bend or damage the measuring line.



## 6.5 Mounting the measuring line to the measuring instrument

1. Shorten the measuring line [1] to the required length (if necessary).
2. Push the hose clamp [2] onto the measuring line [1].
3. Pull the measuring line [1] over the hose adapter [3] at the lower right end of the measuring instrument.
4. Clamp the hose clamp [2] onto the hose adapter [3] using suitable pliers.



---

### INFO

It is possible to connect the device to existing measuring lines (for example, of Unitop or Unitel) using the enclosed hose connector. The second hose clamp is enclosed for this purpose.

If you use existing measuring lines, verify that the measuring line extends to the bottom of the tank.

---

## 7 Adjusting the measuring instrument

The accuracy of the indicated measured values depends on the data entered.

- ▶ In order to display the adjustment menu, briefly press the centre control button (1 x).
- ↵ The measuring instrument switches to display mode after a few seconds.
- ▶ Then press the centre control button (for 3 seconds).

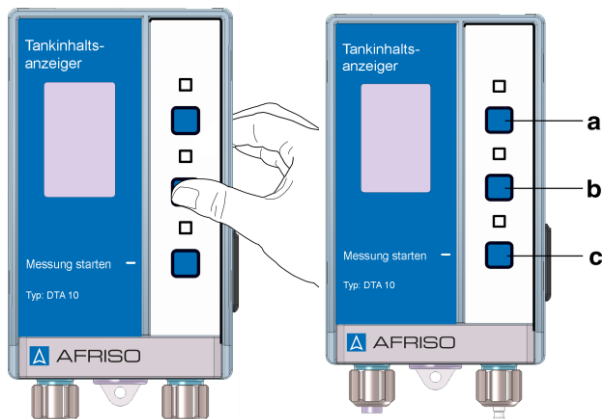

Fig. 7: Displaying adjustments

- a Control button (end)
- b Control button (info)
- c Control button (start)

### 7.1 Adjusting the language

One of the following languages can be selected:

- German
- English
- French

### 7.2 Adjusting the medium

The following media can be selected:

- Water (density 1 g/cm<sup>3</sup>)
- Fuel oil (density 0.84 g/cm<sup>3</sup>)
- Variable (density adjustable form 0.5 – 1.5 g/cm<sup>3</sup>)



### **7.3 Setting the tank shape**

The following tank shapes are available:

- Linear
- Spherical
- Cylindrical horizontal

### **7.4 Adjusting the tank height**

One of the following values can be selected:

- 0 cm to 400 cm

### **7.5 Adjusting the tank volume**

One of the following values can be selected:

- 0 litres to 99999 litres

### **7.6 Adjusting the alarm**

One of the following values can be selected:

- 0 % to 100 %



## 8 Operation

### 8.1 Starting a measurement

- ▶ Press the control button "Start Measurement" to start a measurement.
- ↪ The measured values are displayed after a few seconds.

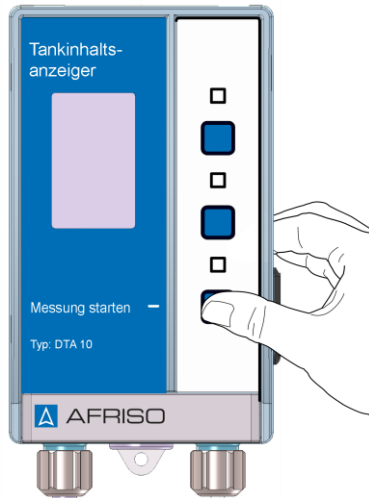

#### Sensor error

In the case of a measurement error (for example, if the measuring line is bent or clogged), the device indicates a *Sensor Error* and the digital display lights red.

## 8.2 Battery status/software indication

- ▶ Briefly press the centre control button (1 x) to display the battery status and software information.
- ↺ After a few seconds, the main display is shown by the measuring instrument.
- ▶ The briefly press the centre control button again (1 x).
- ↺ The battery status and software information of the measuring instrument are displayed.



### 8.3 Switching off the measuring instrument

- ▶ Briefly press the top control button (1 x) to switch off the measuring instrument.
- ▶ The measuring instrument is switched off after a few seconds if no other action is active.

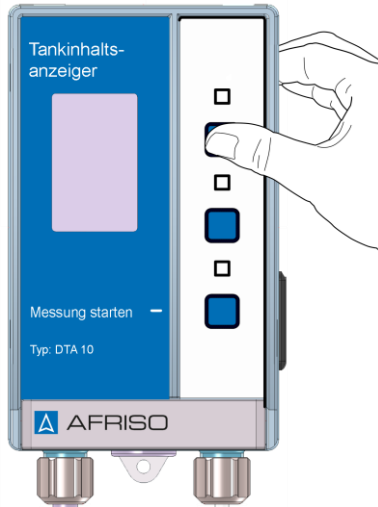

## 9 Troubleshooting

Repairs may only be performed by specially trained, qualified staff.

*Table 2: Troubleshooting*

Problem	Possible reason	Repair
Screen re- mains blank	Monobloc battery (9 V) is empty	▶ Insert a new monobloc battery (9 V)
Incorrect level indication	Incorrect tank data entered Incorrect tank shape entered Measuring line does not extend down to the tank bottom Leak in measuring line	▶ Correct tank data, see chapter 7, page 17 ▶ Check measuring line in tank
Sensor error	Measuring line interrupted/bent End of measuring line is clogged	▶ Check measuring line
Other malfunctions	–	▶ Contact the AFRISO service hotline

## 10 Decommissioning, disposal

### Replacing the battery

1. Remove the old batteries and connect the new battery (see chapter 6.3, page 14).
2. To protect the environment, batteries must not be disposed of together with normal household waste. Return empty batteries to the point of purchase or to special collecting points.

Stored settings are not lost when the battery is replaced.

3. Dismount the digital tank contents indicator DTA 10 (see chapter 6, page 12, reverse sequence of steps).
4. To protect the environment, this product must not be disposed of together with the normal household waste. Dispose of the product according to local directives and guidelines.





This product consists of materials that can be reused by recycling firms. The electronic inserts can be easily separated and the device consists of recyclable materials.

## 11 Spare parts and accessories

Part	Part no.
DTA 10	52145
Measuring line (20 m)	02 16 06 18
Reducer G1½ x G1	20905
Reducer G2 x G1½	20903

## 12 Warranty

The manufacturer's warranty for this product is 24 months after the date of purchase. This warranty shall be good in all countries in which this product is sold by the manufacturer or its authorised dealers.

## 13 Copyright

The manufacturer retains the copyright to these operating instructions. These operating instructions may not be reprinted, translated, copied in part or in whole without prior written consent.

We reserve the right to technical modifications with reference to the specifications and illustrations in this manual.

## 14 Customer satisfaction

Customer satisfaction is our prime objective. Please get in touch with us if you have any questions, suggestions or problems concerning your product.