



Kaskode One – Phono Preampfier



Owner's Manual

www.bandwidthaudio.com
sales@bandwidthaudio.com



WARNING



Configuration of the Kaskode One will require removing the cover of the unit. Before removing the cover for any reason, make sure to power off the unit and unplug from mains wall outlet.

Wait a minimum of 60 seconds for all voltage to dissipate before opening the cover.

FAILURE TO READ OWNER'S MANUAL BEFORE FIRST USE CAN VOID YOUR WARRANTY

	<p>CAUTION RISK OF ELECTRICAL SHOCK. DO NOT REMOVE COVER WITH POWER CONNECTED REPLACE FUSE WITH SAME TYPE AND RATING</p>
---	---

	<p>WARNING TO PREVENT FIRE AND SHOCK HAZARD, DO NOT EXPOSE THIS DEVICE TO RAIN OR MOISTURE. DO NOT OPERATE WITH COVER REMOVED. UNIT CONTAINS VOLTAGES WHICH MAY BE HAZARDOUS. REMOVE SOURCE OF POWER BEFORE SERVICE.</p>
---	---

CONTAINS LETHAL VOLTAGES

High voltage can be lethal. Do not remove cover while the preamplifier is connected to the Mains power source. For service, contact Bandwidth Audio.

HIGH VACUUM TUBE TEMPERATURES

Vacuum tubes can get extremely hot with bulb temperatures capable of reaching 200°C. Do not touch or attempt to remove the tubes while they are hot.

DO NOT ENCLOSE

This preamplifier will get warm from use. Make sure to place the equipment in a non-enclosed area with good ventilation and air flow.

Table of Contents

1.0 Kaskode Connections and Setup	6
1.1 Phono Preamplifier Placement.....	6
1.2 Mains AC Grounding.....	7
1.3 Powering ON & OFF.....	7
1.4 Installing Optional (MC) Moving Coil Module.....	9
1.5 Moving Coil Input Connections.....	10
1.5.1 Balanced / Unbalanced Input.....	10
1.6 Moving Magnet Input Connections.....	11
1.7 Kaskode One Input Wiring Diagram.....	11
1.8 Tonearm and Turntable Wiring.....	12
1.8.1 RCA Connection.....	12
1.8.2 XLR Connection (MC Only).....	13
1.9 Subsonic Filter.....	15
2.0 Cartridge Loading	16
2.1 MM Cartridge Loading Options.....	16
2.1.1 MM Input Resistance.....	16
2.1.2 MM Input Capacitance.....	16
2.2 MC Cartridge Loading Options.....	20
2.2.1 MC Input Resistance.....	20
2.2.2 Selecting the MC Step-up Ratio.....	23
2.2.3 Selecting the Rsl value for Cartridge Loading.....	26
3.0 Controls and Layout	28
3.1 Front Features.....	28
3.2 Back Features.....	29
4.0 Typical Specifications	31
5.0 Notes	33

List of Figures

Figure 1: White markers indicate correct MC orientation.....	9
Figure 2: Input Wiring Diagram	11
Figure 3: Turntable Wiring for RCA Input.....	12
Figure 4: XLR Pinout (Front View).....	13
Figure 5: Turntable Wiring for XLR Option 1.....	14
Figure 6: Turntable Wiring for XLR Option 2.....	14
Figure 7: Location of J3/J4 subsonic filter jumpers.....	15
Figure 8: MM frequency response with input capacitances.....	16
Figure 9: Location of S2 and S5 switches for setting the input capacitance	17
Figure 10: S2/S5 setting for 150pF.....	18
Figure 11: Input Network for MC Input.....	20
Figure 12: Location of Step-up ratio switches	24
Figure 13: Location of Rsl selection switches S1 and S4	26
Figure 14: S1/S4 Rsl setting for 10000 Ω	27

1.0 Kaskode Connections and Setup

From the factory, the Kaskode One is configured as follows:

- Subsonic filter is active
- MC Step up module (if installed) is configured for unbalanced operation
- MC Step up module (if installed) ratio is set 1:10
- Input capacitance is set to 150pF
- Rsl Cartridge loading is set to $10K\Omega$ = MC input resistance of 100Ω

Pre-Operation Checklist

- Before your first use, check that the Kaskode One is configured correctly for your phono cartridge.
 - To set the input loading for MM cartridge, see 2.1
 - To set the input loading and step up ratio for MC cartridge, see 1.0
- If using MC, check input connection type (Balanced or Unbalance) to match your setup, see 1.5
- If using MM, check input connection, see 1.5.11.6
- For turntable and tonearm wiring best practices, see 1.8
- To set Subsonic filter to your preference, see 1.9

1.1 Phono Preamplifier Placement

For the best operation and longest life of components, the preamplifier should be set up and used in a well-ventilated area with good air circulation. Do not use the amplifier in enclosed furniture as overheating can damage the amplifier, diminish tube life and cause risk of fire.

Due to the extremely high gain, phono preamplifiers are extremely sensitive to vibration. It is always recommended to place the phono preamplifier on a sturdy, substantial shelf to help minimize vibrations coupled in from the floor.

Radiating electromagnetic noise (EMI) from sources such as large transformers, cellphones and Wi-Fi routers can also cause audible noise from the speakers if this equipment is placed too close to phono circuitry. It is best to have this equipment located far away.

1.2 Mains AC Grounding

Always share the same AC mains ground circuit with all other audio equipment.

For lowest noise, it is always recommended to share the same AC mains ground circuit between all audio equipment in a system. The easiest and best way to achieve this is to share a common wall and use a quality power strip to power all pieces of equipment. This is most desirable to ensure the ground reference of all audio equipment is at the same potential.

Ground is used as a safety voltage reference and should not have any current flowing. However, it is likely that any 2 ground circuits in a building's wiring will have a small voltage differential across them. If these grounds are shared by audio equipment, a ground loop is formed and the small voltage differential can now drive a current through the audio ground, causing noise.

Faulty equipment on the AC line can also be a source of ground noise.

1.3 Powering ON & OFF

The Kaskode One is designed with a time delay start sequence to ensure that all operating voltages are stabilized and the preamplifier is ready to play audio before the output is active. This removes the chance of any pop and noise during power on and off. The Kaskode One can be turned on and off without any need for power sequencing with other equipment. The "Active" indicator on the front panel shows the status of the power-on sequence. The preamp output will be active approximately 60 seconds after powering on.

The power on sequences is as follows:

The Kaskode One "Power" indicator will illuminate. The "Mode" and "Mute" settings will also illuminate with their status. After a delay of approximately 60 seconds, the "Active" indicator will illuminate, indicating that the phono preamp is ready for use and music can be played.

1.4 Installing Optional (MC) Moving Coil Module

The Kaskode One features optional plug-in transformer modules to also support MC type cartridges. If your preamp was ordered with the MC option, these transformers have already been installed at the factory.

To install the MC modules:

Align the MC modules so that the white orientation markers are aligned on both the main preamp PCB and the PCB of the module.

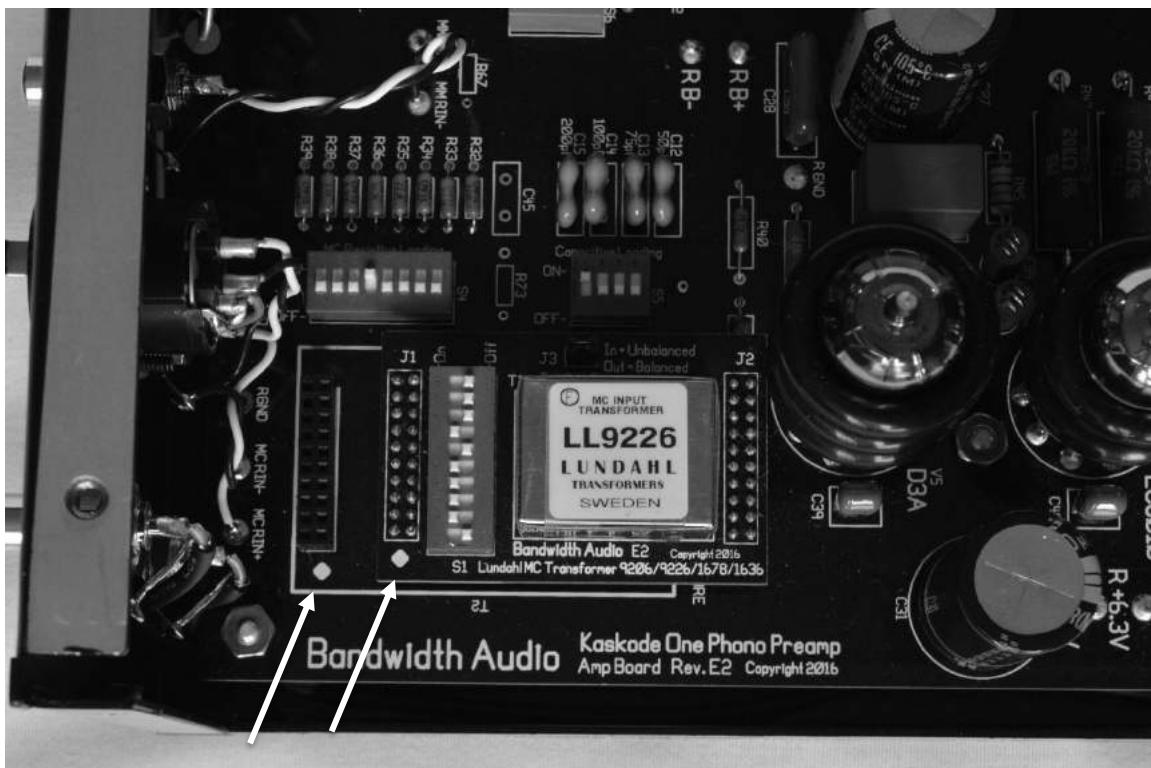

Figure 1: White markers indicate correct MC orientation

After the correct orientation has been found, carefully plug the modules into the female header pin sockets on the main PCB. Be careful not to misalign the pins. Press gently until the MC module is fully seated.

1.5 Moving Coil Input Connections

For MC input mode, additional gain is provided by optional step-up transformers. With the step-up module installed, either the RCA or XLR inputs labeled "MC" on the back of the unit can be used, provided the input "Mode" switch on the front is set to "Moving Coil." If no MC module is present, the MC inputs cannot be used.

1.5.1 Balanced / Unbalanced Input

Jumper J3, located on the optional MC module, is used to select between balanced or unbalanced input. Balanced input is achieved with jumper J3 removed by isolating the primary and secondary ground of the MC transformer. In balanced operation, the MC transformer will provide a high degree of common mode rejection, helping to remove noise picked up in the cabling between the preamplifier and turntable. Always disconnect the power cord before making any adjustments to the phono preamp. (See Figure 2: Input Wiring Diagram)

In balanced input mode, either the RCA or XLR input can be used; **however, the XLR input is recommended.** When using a high quality 3-conductor XLR cable, the positive (+) and negative (-) signals are a twisted wire pair covered by a metal shield. The +/- pair connects to the MC transformer and the shield is connected to the preamp chassis. Not only does the shield provide hum rejection, but the +/- twisted wire pair is naturally balanced such that any noise that penetrates the shield is removed by the common mode rejection of the MC transformer.

In contrast, an RCA cable is a 2-conductor unbalanced cable. The positive (+) signal flows through the center of the negative (-) shield. Therefore, the geometry and surface area of the + and - conductors are not identical, and noise will not couple uniformly on both conductors. Therefore, the transformer's common mode rejection will not help remove noise.

- **When using an RCA cable for the MC input, unbalanced connection is recommended.**
- **When using an XLR cable for the MC input, either unbalanced or balanced connection can be used.**
- **Remember to set J3 on both MC module boards.**

1.6 Moving Magnet Input Connections

For MM input, the RCA connectors labeled "MM" on the back of the unit should be used. These inputs bypass the MC step-up module as well as the resistive loading. Moving Magnet-type cartridges will require setting the capacitive loading.

1.7 Kaskode One Input Wiring Diagram

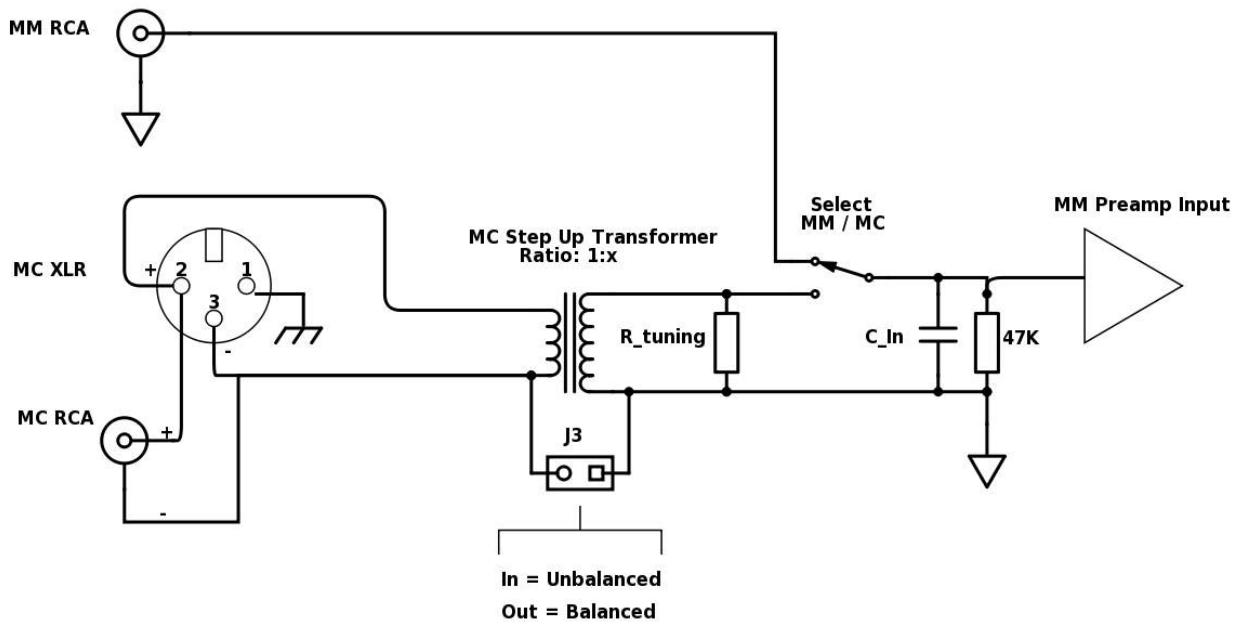

Figure 2: Input Wiring Diagram

Figure 2 above shows how the inputs for the MM and MC sections are wired. Notice that both the MC RCA and MC XLR inputs can be wired as unbalanced or balanced by connecting or removing jumper J3.

1.8 Tonearm and Turntable Wiring

It is critical that the turntable used with the phono preamplifier that has been properly wired to ensure lowest noise and best performance.

1.8.1 RCA Connection

When using RCA cables to connect the turntable to the Kaskode One, no part of the RCA connector on the turntable should be connected to the plinth or tonearm. The RCA connector should only connect to the cartridge. For most cartridges, a pair of RCA connectors is used for Left (L) and Right (R) stereo channels. The Left and Right signals should also be completely independent from each other with no shared connection.

With no cable connected to the turntable, use a multimeter set to measure resistance in Ohms (Ω) to check the continuity between the grounds (outer shell) of the L/R channel RCA connectors. Next, check between the RCA connector and any metal on the turntable plinth or tonearm, repeat for the other channel. In both cases, the meter should read an extremely high resistance ($M\Omega$), indicating no connection. If the meter does read a low resistance value, it is suggested to have your turntable rewired for correct operation.

Note: The plinth and tonearm should be connected to the turntable's external ground wire, which should also be connected to the "Ground" terminal of the Kaskode One.

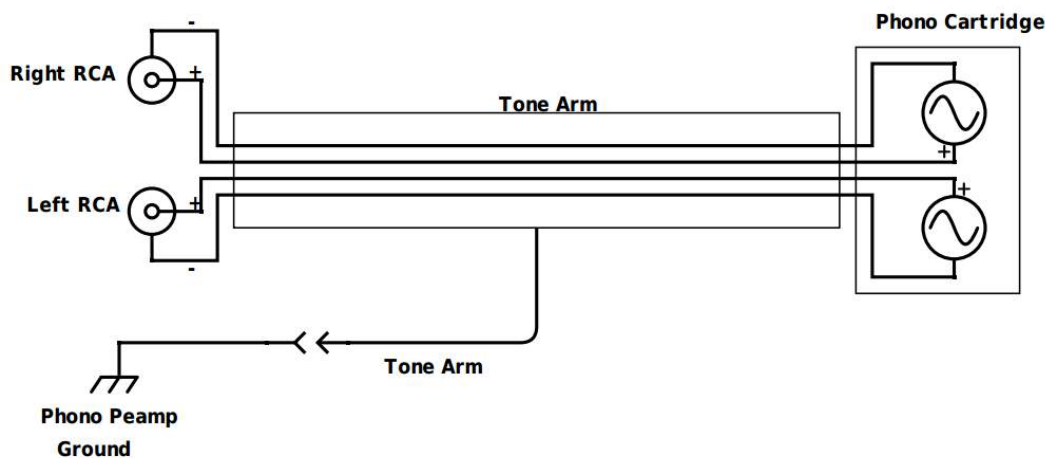

Figure 3: Turntable Wiring for RCA Input

Figure 3: Turntable Wiring for RCA Input above shows the correct wiring for RCA connection to the Kaskode One. Note that the RCA jacks are completely isolated from each other and from the tonearm. In this case, the tone arm is connected to the Kaskode One ground connection through a separate wire. The tonearm now acts as an electric shield around the wires that connect to the cartridge. This ground may or may not also connect to the plinth of the turntable.

1.8.2 XLR Connection (MC Only)

When using 3-pin XLR cables to connect the turntable to the Kaskode One, the Positive (+) and Negative (-) connections on the turntable XLR connector should be completely independent from each other. Also, there should be no shared connection between Left and Right channels. XLR cables also have an outer shield that is tied to earth ground.

Note: On the Kaskode One XLR input, Pin-1 is always tied to Earth ground. This will shield the entire length of the cable to suppress noise.

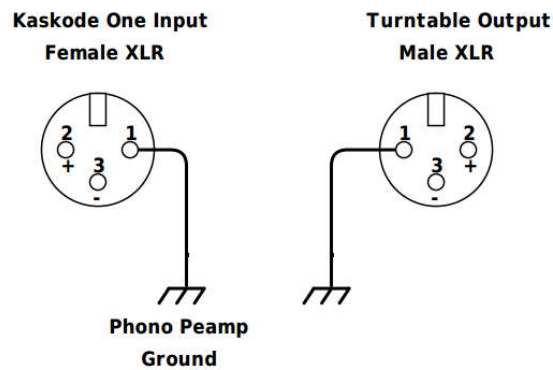

Figure 4: XLR Pinout (Front View)

It is perfectly acceptable to have the Pin-1 shield also connected to the plinth or tonearm at the turntable side of the cable. In this case, an external ground wire from the turntable plinth and tonearm to the Kaskode One ground lug is not required.

However, if the Pin-1 shield is not connected to the plinth or tonearm, external ground wire is required.

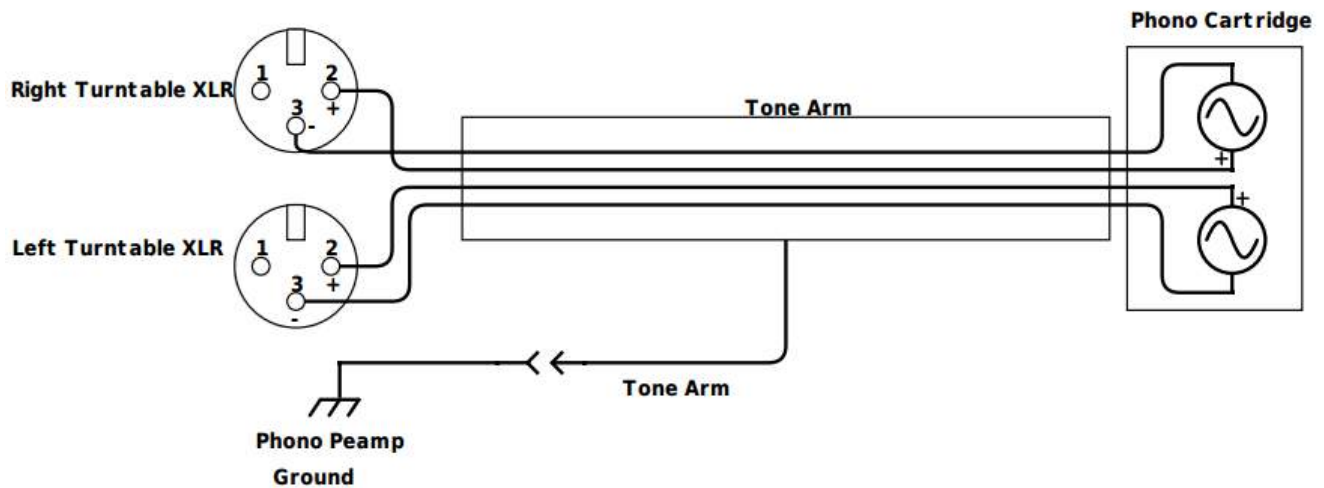

Figure 5: Turntable Wiring for XLR Option 1

Figure 5: Turntable Wiring for XLR Option 1 shows Option 1 of turntable wiring for XLR input, in this case Pin-1 on the turntable XLR connector is not connected. The XLR cable is still shielded through Pin-1 on the Kaskode One input XLR ground, so there is still hum rejection. However, the plinth and tonearm are floating, so a wire to connect these parts to the Kaskode One "Ground" terminal is required.

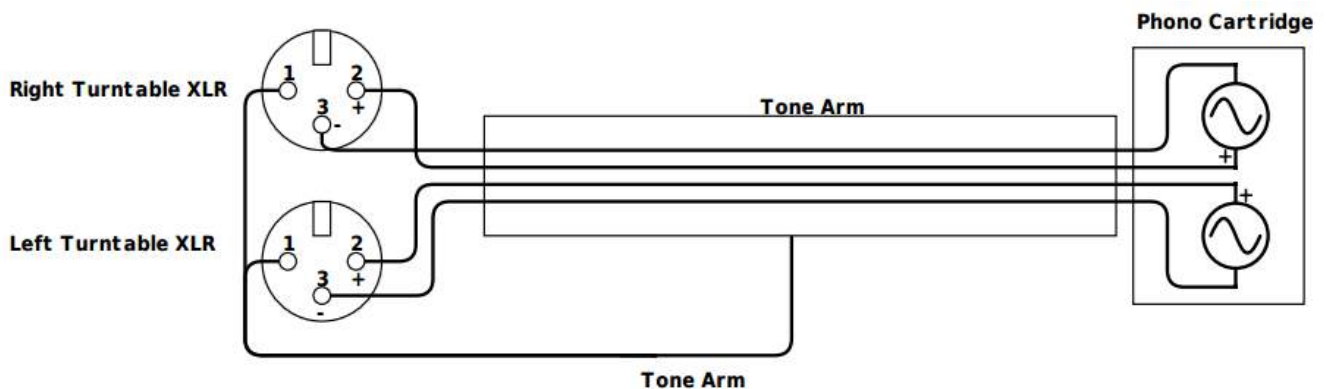

Figure 6: Turntable Wiring for XLR Option 2

Figure 6: shows a second option where pin-1 on the turntable XLR connector is connected to the plinth and tonearm. Therefore, it is also connected to the Kaskode One ground through the shield of the XLR cable. In this case, no external ground wire is required.

1.9 Subsonic Filter

The Kaskode One has a selectable subsonic filter to help remove any unwanted subsonic noise or rumble due to warped records and other low frequency mechanical noise. This is in accordance with the 1976 IEC Amendment for the RIAA equalization curve during playback. This is a 6dB slope filter placed at 7950uS or approximately 20Hz.

It is generally a good idea to use this filter so that inaudible low frequency noise is not passed to components downstream, consuming amplifier headroom and shifting the DC operating point of both the electronics and the speakers.

The filter is selected by installing or removing jumpers J3 and J4 on the main PCB.

J3/J4 Installed = No Subsonic Filter

J3/J4 Removed = Subsonic Filter Active

The figure below shows the location of jumper J3 and J4. **Note that the subsonic filter jumpers are from the factory, enabling the filter.**

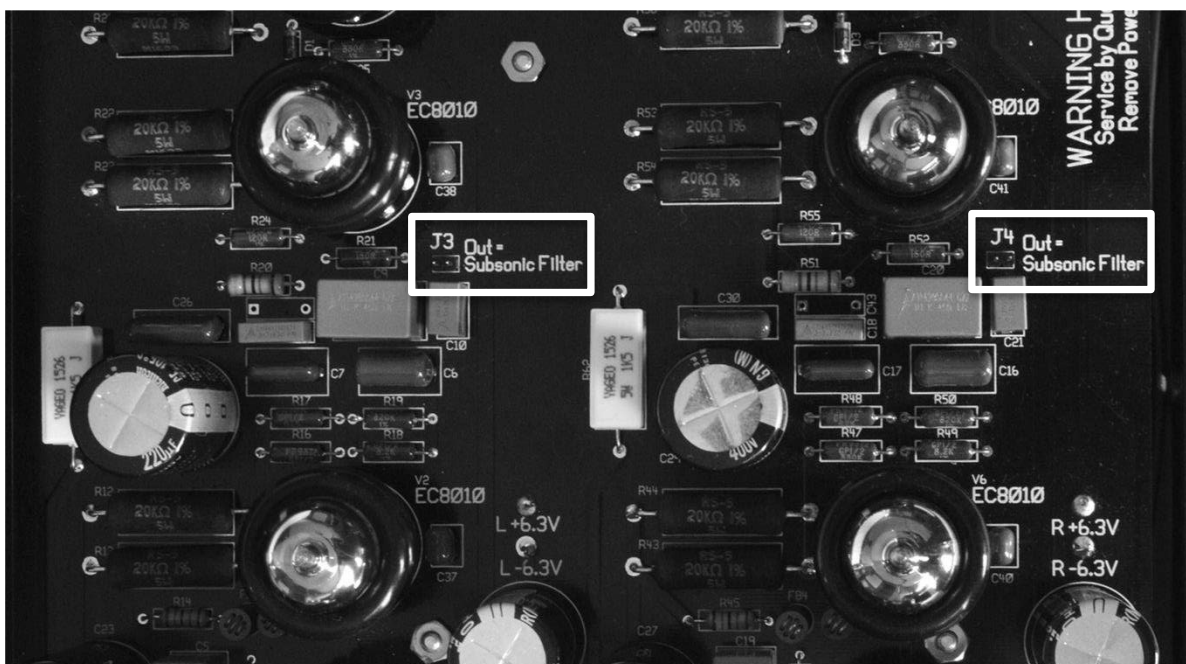

Figure 7: Location of J3/J4 subsonic filter jumpers

2.0 Cartridge Loading

Cartridge loading is one of the most critical aspects to obtaining the best sound from your records. A good loading will maximize the frequency response from your cartridge without any peaking at high frequencies.

2.1 MM Cartridge Loading Options

2.1.1. MM Input Resistance

Moving magnet cartridge types are typically designed to operate into a 47K Ω resistance. The MM input of the Kaskode One has been set to 47K Ω .

2.1.2. MM Input Capacitance (S2/S5)

Input capacitance loading for MM cartridge types is extremely important for best performance. The user will need to set the input capacitive loading for a Moving Magnet cartridge to optimize the frequency response. It is recommended to start with your cartridge manufacturer's recommended settings and then adjust as needed for best sound quality. If the input capacitance is too large, there is severe peaking in the high frequency response. If the input capacitance is too low, high frequency response is attenuated.

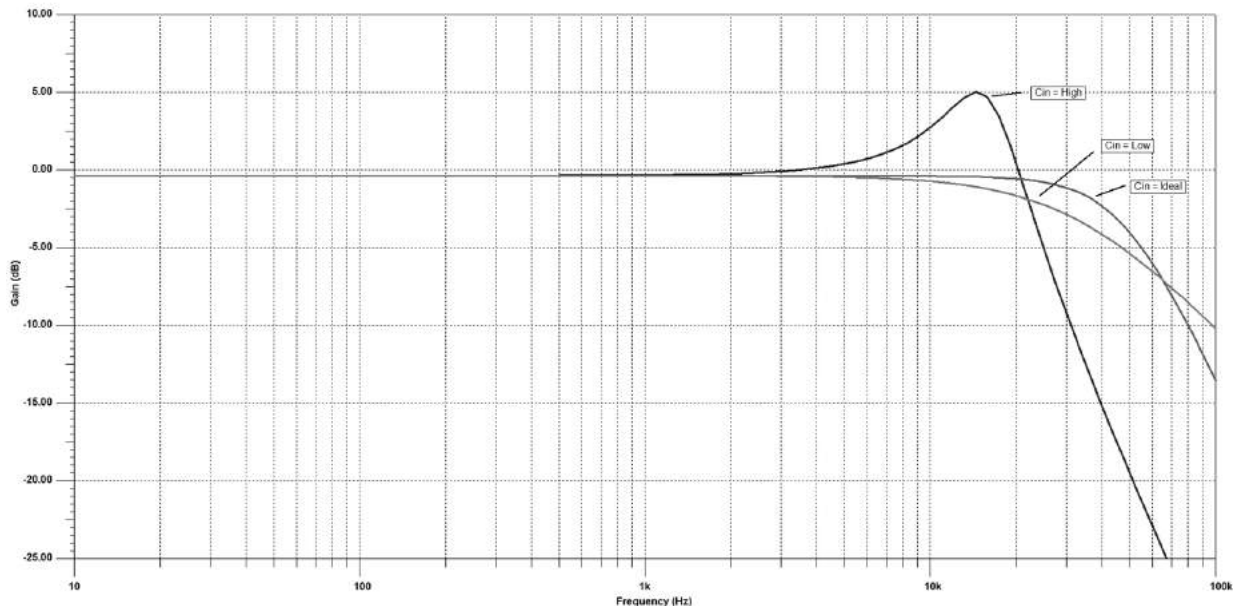

Figure 8: MM frequency response with input capacitances

Switches S2 and S5 are used to set the capacitive loading (S2 for the Right channel and S5 for the Left channel) by moving the switches in positions 1-4 to be indicated to the "ON" position.

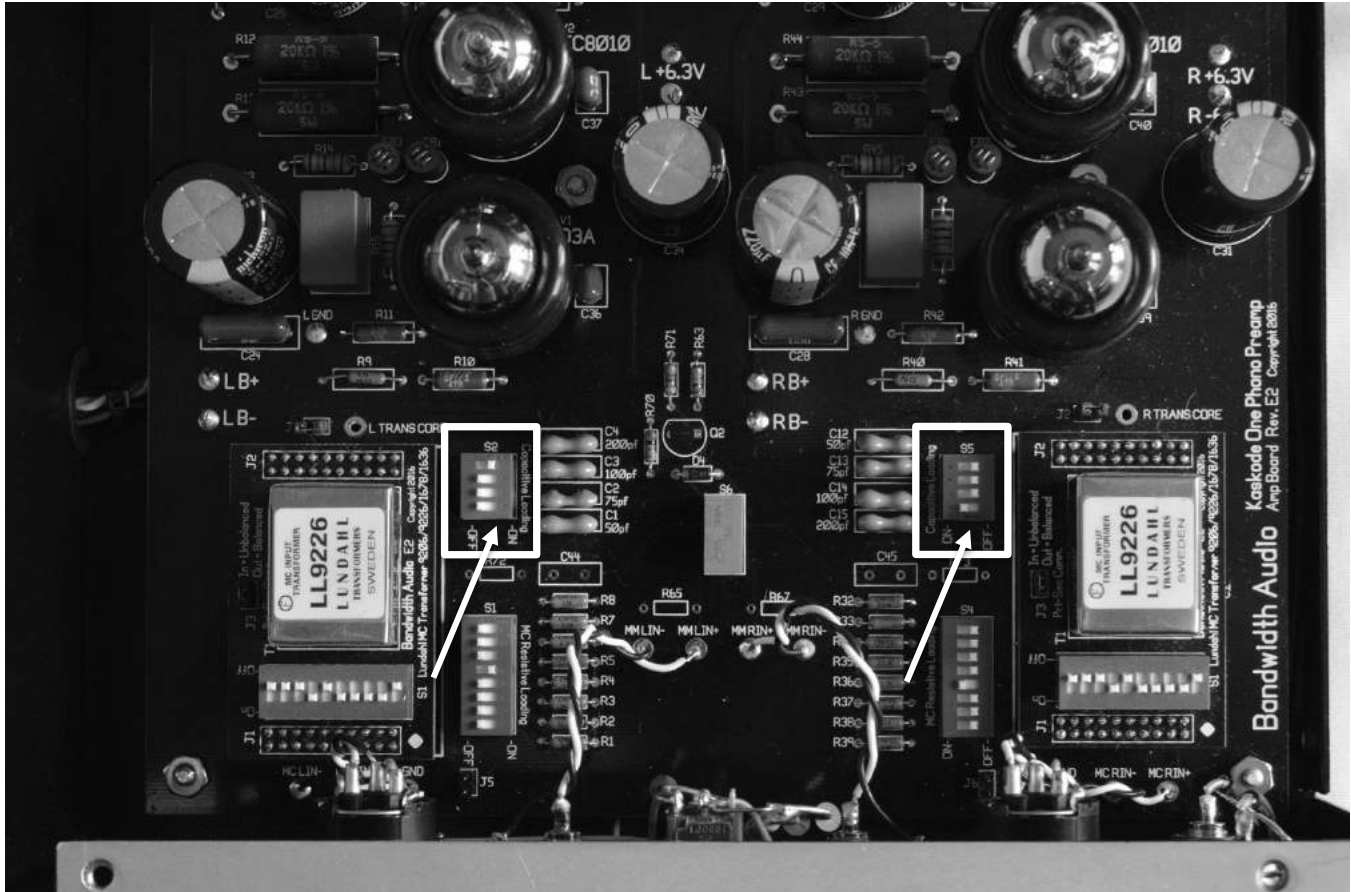

Figure 9: Location of S2 and S5 switches for setting the input capacitance

Note: Orientation of S2 and S5 are rotated 180° from each other. Be sure to set both S2 and S5 identically.

The desired input capacitance is enabled with each switch position. Combinations of capacitance are also enabled by moving multiple switch positions to "ON". The table below shows all 15 input capacitance combinations available on the Kaskode One to dial the best performance with any cartridge.

S2/S5 Capacitance Loading Table	
Position ON	Capacitance
1	200pF
2	100pF
3	75pF
4	50pF

Table 1: Input Capacitance for each switch

S2/S5 Capacitance Loading Table	
Position ON	Capacitance
1,2,3,4	425pF
1,2,3	375pF
1,2,4	350pF
1,3,4	325pF
1,2	300pF
1,3	275pF
1,4	250pF
2,3,4	225pF
1	200pF
2,3	175pF
2,4	150pF
3,4	125pF
2	100pF
3	75pF
4	50pF

Table 2: Input Capacitance Combinations

The figure below shows how switches S2/S5 should be set for 150pF of input capacitance.

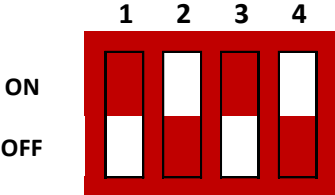

Figure 10: S2/S5 setting for 150pF

Total Input Capacitance:

Total input capacitance seen by the phono cartridge includes the set capacitance by S2/S5, any cable capacitance between the turntable and phono preamp, and the native input capacitance (no additional selected capacitance) of the phono preamp.

The native input capacitance of the Kaskode One is an extremely low 15pF. This allows the user to better tune the capacitance for their desired cartridge. To keep tunability at a maximum, it is suggested to use very low capacitance cables between the turntable and Kaskode One and use S2/S5 switches to precisely set input capacitance.

$$C_{total} = C_{s1/s5} + C_{cable} + 15pF$$

Equation 1: Total input capacitance

2.2 MC Cartridge Loading Options

2.2.1. MC Input Resistance

For Moving Coil cartridges, the critical tuning parameter is the input resistance for loading the cartridge. Since the Kaskode One uses a step-up transformer for MC cartridges, the loading is dependent on the step-up ratio used. Based on the desired step-up ratio, the proper Secondary Loading Resistance (R_{sl}) must be selected for the desired cartridge load.

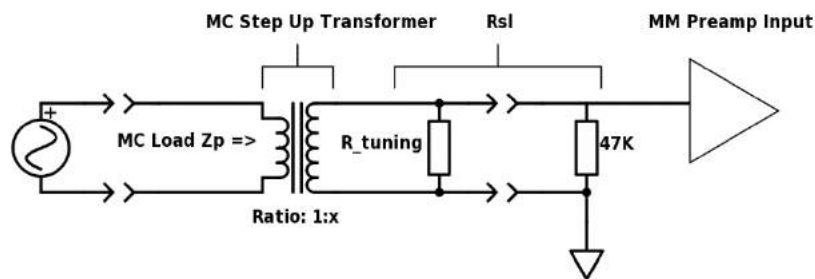
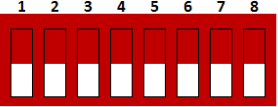







Figure 11: Input Network for MC Input

From Figure 11 above, the load seen by the MC cartridges is the R_{sl} impedance, reflected from secondary to the primary (input side) of the MC transformer. For the same R_{sl} value, the step-up ratio will change the reflected impedance on the primary side of the transformer, and thus the MC loading. R_{sl} is the parallel combination of the tuning resistor R_{tuning} and the standard $47K\Omega$ resistance of the MM preamp input.

Table 3 below shows the cartridge loading input resistance for the available values of Rsl. The different step-up ratios are also shown (1:5, 1:10 and 1:20).

S1/S4 Table for Desired Rsl See Section 2.2.3	Secondary Loading Resistance (Rsl) Ω	1:5	1:10	1:20
		MC Cartridge Load Resistance (Z_p) Ω		
	47000	1910	478	119
	39000	1590	398	99
	30000	1230	308	77
	20000	830	208	52
	15000	630	158	39
	10000	430	108	27
	5586	254	63	16
	3170	157	39	10
	1000	70	18	4

Rsl value of 3170 Ω is not recommended for 1:20 step-up ratio. Rsl value of 1000 Ω is not recommended for 1:10 and 1:20 step-up ratios. These setting can be experimented with but may not achieve desirable results.

Table 3: Cartridge loading based on Rsl

Example:

For a 1:10 step-up ratio and a desired cartridge load of 100Ω , the Rsl value of 10000Ω (10K Ω) is the best fit.

It is suggested to start with an Rsl value that will give the cartridge manufacturer's recommended load value, and then tune to taste.

See section 2.2.2 for selecting the MC Step-up Ratio

See section 2.2.3 for selecting the Rsl value

Note: For best selection of MC cartridge loading and step-up ratio, it is suggested to use Bandwidth Audio MC cartridge calculator, available from www.bandwidthaudio.com

2.2.2 Selecting the MC Step-up Ratio

The goal of the MC transformer is to take the small output voltage from moving coil type cartridges and scale the voltage such that it is suitable for the input of the MM phono preamp input.

The Kaskode One has selectable 1:5, 1:10, and 1:20 transformer step-up ratios for 60dB, 66dB, or 73dB total gain, respectively. The best way to select the correct step-up ratio is to calculate the approximate output voltage from the transformer. Simply multiply the desired step-up ratio by the MC cartridge nominal output voltage (V_{MC}). The output voltage for the MC cartridge should be stated by the manufacturer.

$$V_{MC} \times \text{Stepup ratio} = V_{out}$$

Equation 2: MC voltage after step-up

The MC transformer ratio should be selected such that V_{out} in the range of 3-7mV.

For example

A manufacturer specifies the output of a MC cartridge as:

0.5mV (500uV) @ 5cm/s

A setup ratio of 1:10 would yield an output voltage of 5.0mV (5000uV). This is in the recommended range of 3-7mV.

The actual output voltage will likely be a little bit less than this, due to the resistive loss of the MC step-up transformer. It is suggested to use the Bandwidth Audio MC cartridge calculator, available from www.bandwidthaudio.com, for more accurate analysis of the output voltage.

The MC step-up ratio is selected by setting the dip switches on the MC module board. The figure below shows the location of the switches.

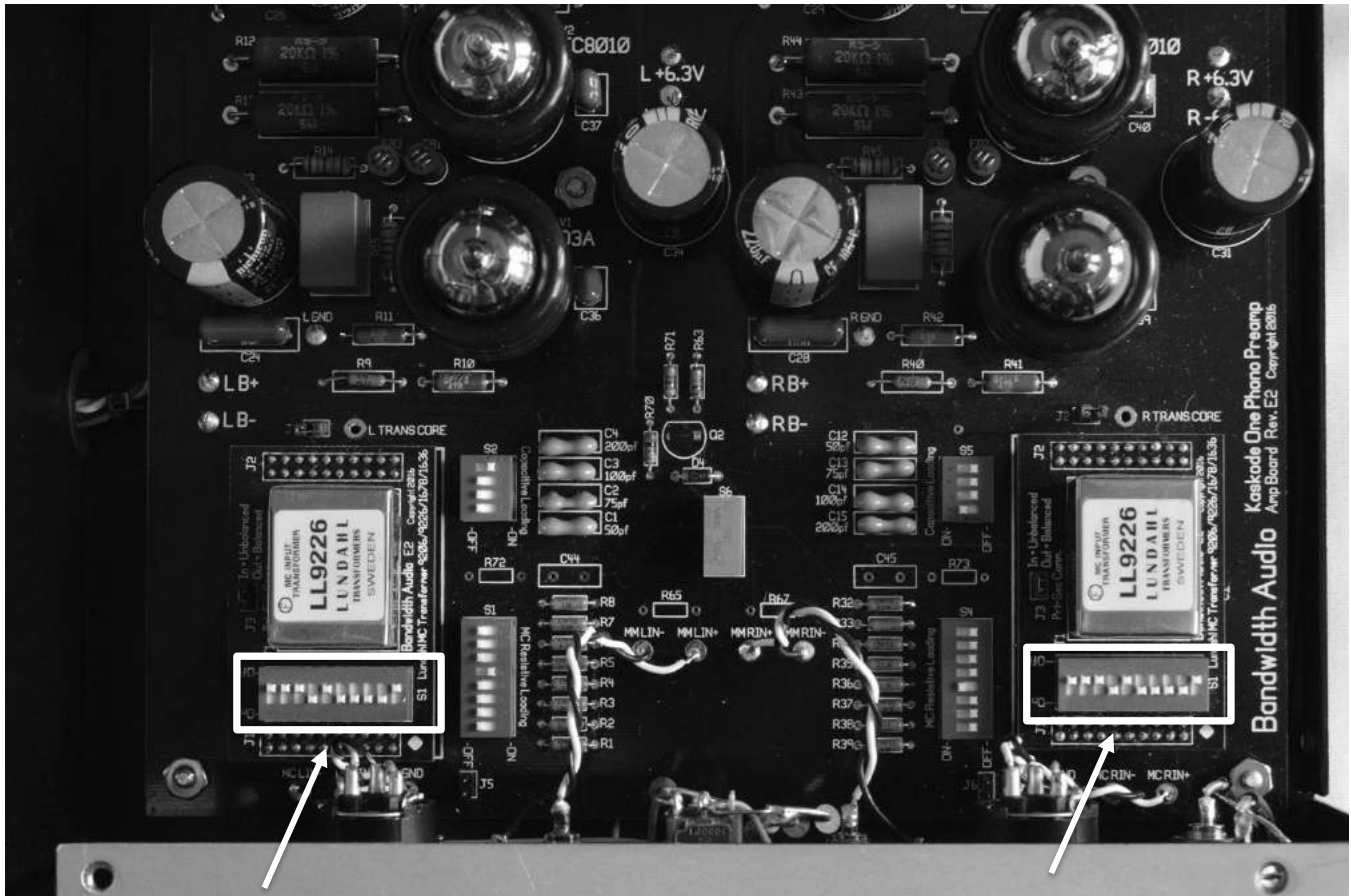
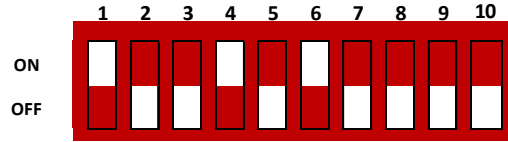
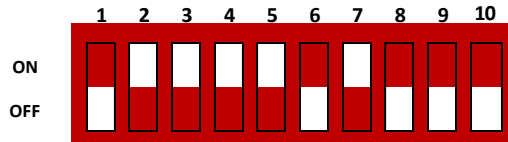

Figure 12: Location of Step-up ratio switches

The diagrams below show the MC module switch configuration for the following step-up ratios:



1:5 Step-up Ratio



1:10 Step-up Ratio

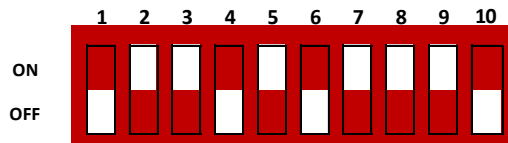

1:20 Step-up Ratio

2.2.3. Selecting the Rsl value for Cartridge Loading

The Rsl value for the desired cartridge loading as shown in Table 3 in **Section 2.2.1**, is selected using switches S1 and S4 on the main PCB. The location of S1 and S4 is shown below.

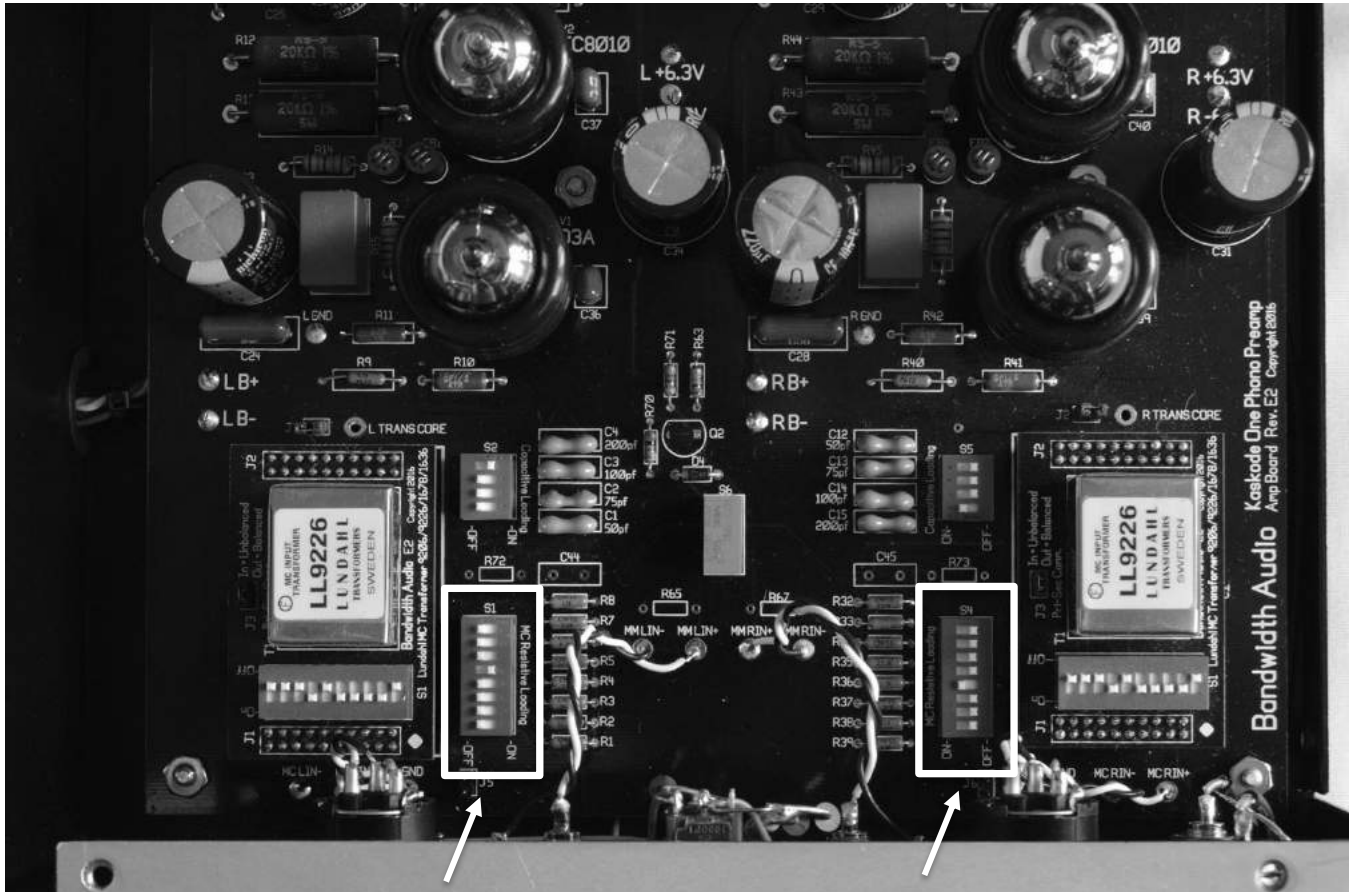

Figure 13: Location of Rsl selection switches S1 and S4

Note: Orientation of S1 and S4 are rotated 180° from each other. Be sure to set both S1 and S4 identically.

The Rsl value is selected by moving the desired switch position to the "ON. The table below shows the Rsl value when the indicated switch is moved to "ON."

Rsl S1/S4 Table	
Position ON	Rsl
None	47000 Ω
1	1000 Ω
2	3170 Ω
3	5586 Ω
4	10000 Ω
5	15000 Ω
6	20000 Ω
7	30000 Ω
8	39000 Ω

Table 4: Rsl based on switch position moved to "ON"

The figure below shows the correct switch setting for a Rsl of 10000Ω.

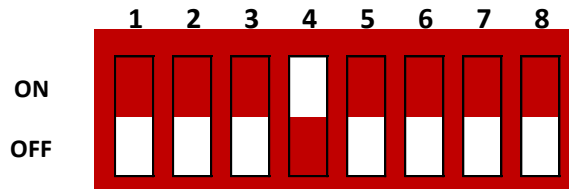

Figure 14: S1/S4 Rsl setting for 10000Ω

2.2.4 MC Input Capacitance (S2/S5)

The both the MC and MM inputs share the same input capacitance. Typically for MC cartridges, the capacitance should be set to a minimum. If desired, capacitance can be added to soften the high frequency response. It is recommended to tune this by ear. See **Section 2.1.2** for details on setting the input capacitance.

3.0 Controls and Layout

3.1 Front Features



- 1. Power LED The Power LED illuminates when power to the preamp is switched on.

- 2. Active LED The Active LED indicates the status of the time delay startup sequence. The time delay removes the chance of pop or noise on power on. During the warmup period the LED is off, indicating the unit is held in an automatic mute. Approximately 60 seconds after power on, the LED will illuminate indicating the preamplifier is active and ready to use.

- 3. Mode Selects either Moving Coil or Moving Magnet inputs. LED indication shows which input is active.

- 4. Mute Used to mute the output of the preamp. The switch is active in the up position. LED indication will show when mute is active.

- 5. Power Used to turn the amplifier on and off. **On** is in the up position, **Off** is in the down position

3.2 Back Features



- 1. Mains Input Socket to connect removable wall power cord to the amplifier. ***Use only the voltage indicated on the serial number tag below mains input.***

2. Mains Fuse For 115-120VAC **Use only 1.25 Amp Slow Blow Fuse**
For 230-240VAC **Use only 0.75 Amp Slow Blow Fuse**
Check serial number tag for correct mains voltage. Fuse is a 5x20mm glass cartridge. Fuse is in series with the mains current to protect the user and amplifier from various short circuit failures.
3. MC Input Input used for Moving Coil cartridges. Both RCA and XLR connectors are available. The MC Input can be configured for balanced or unbalanced connection. Connectors are duplicated for Left and Right channels.
4. Ground Binding post used for ground connection to turntable. Accepts both bare wire and banana style connectors.
5. Ground Lift In the left position, the phono circuit is weakly connected to mains earth ground to eliminate noise from any ground loops created between other earth grounded audio equipment. In the right position, the phono circuit ground is hard-connected to mains earth ground.
6. MM Input RCA inputs used for Moving Magnet cartridges. Connectors are duplicated for Left and Right channels.
7. Output Pair of RCA outputs to connect the Kaskode One to a line level preamp or power amplifier.

4.0 Typical Specifications

Gain MM Mode

46dB

Gain MC Mode (Selectable)

60dB (1:5 Step-up)

66dB (1:10 Step-up)

72dB (1:20 Step-up)

Channel Balance (Both MM and MC)

<0.2dB

THD+N (MM with 3.5mV Input at 1KHz)

<0.05%

RIAA Accuracy

+/- 0.2dB from 20Hz to 40KHz

Frequency Response (-3dB down)

<10Hz and above 175KHz

MM Input referred Noise (A-weighted)

0.2uV

-132dBu

-88dB SNR relative to 5mV input

MC Input referred Noise - 1:10 66dB mode (A-weighted)

0.058uV

-142dBu

-72.5dB SNR relative to 250uV input

Rated Output

15V at 0.5% THD+N

MM Input Resistance

47K Ω

Input Capacitance (Selectable)

50pF, 75pF, 100pF, 125pF, 150pF, 175pF, 200pF, 225pF, 250pF, 275pF, 300pF, 325pF, 350pF, 375pF or 425pF

MC Input Resistance for each Step-up Ratio (Selectable)

60dB (1:5): 1910 Ω , 1590 Ω , 1230 Ω , 830 Ω , 630 Ω , 430 Ω , 254 Ω , 157 Ω or 70 Ω

66dB (1:10): 478 Ω , 398 Ω , 308 Ω , 208 Ω , 158 Ω , 108 Ω , 64 Ω or 39 Ω

72dB (1:20): 119 Ω , 99 Ω , 77 Ω , 52 Ω , 39 Ω , 27 Ω or 16 Ω

Recommended Load (Output)

10K Ω or greater

Tubes (Tested and Matched in House)

2x D3A NOS Gold Pin Siemens

6x EC8010 NOS Gold Pin Siemens

Voltage

Available in 115-120VAC or 230-240VAC

Power Consumption

90 Watts

Dimensions (Includes faceplate and feet)

17.5" x 14.25" x 4.5"

Due to the open loop design of this preamplifier, actual performance will vary depending on vacuum tube quality. Specifications subject to change.

5.0 Notes:

Date: _____ Note: _____

Date: _____ Note: _____

Date: _____ Note: _____

Date: _____ Note: _____

General Notes: _____

