

Open Show #1

April 30<sup>th</sup>

Patterns

Williamsport Riding Club  
Open Show #1  
Hunt Seat Equitation on the Flat

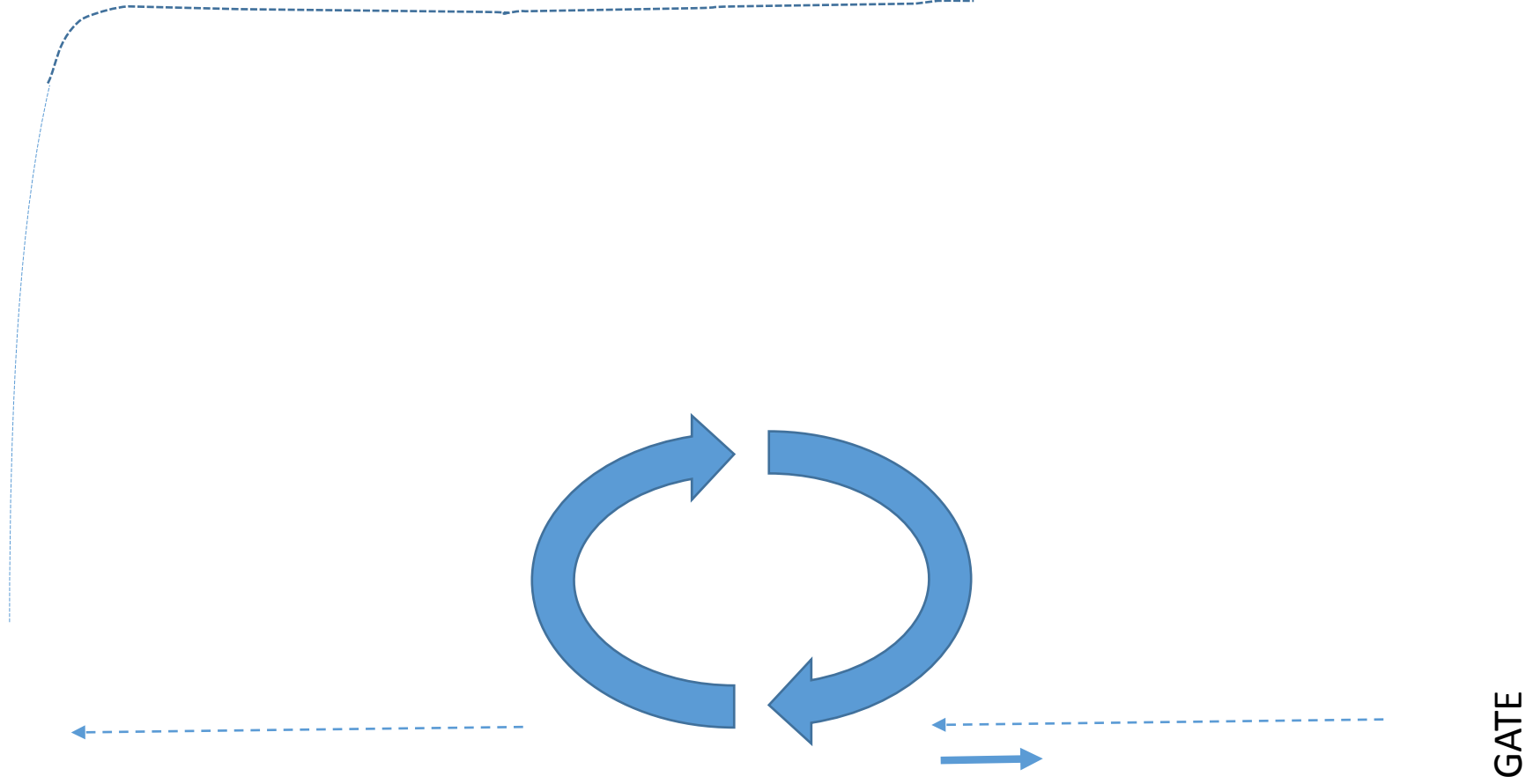

Enter ring at a medium trot, sitting with your feet out of stirrups.  
Halt back 4 steps. Pick up your irons. Circle right 20 meters sitting trot.  
Perform a rising trot to the end of the ring. Track right. Then break to the extended walk. Take a place on rail.

# Jumping Courses

Williamsport Riding Club  
Open Show #1  
Set up

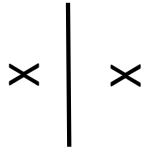

60ft

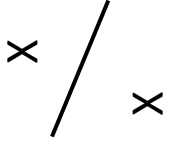

72 ft

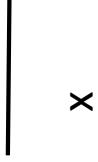
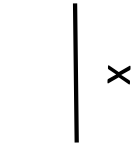
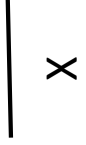

Gate

# Williamsport Riding Club

## Open Show #1

Trot Cross Rail Equitation (10 & Under & Novice)

Cross Rail Equitation (Jr. Youth & Sr. Youth)

2



5



60 ft



1

72 ft

6

3



4



Gate

# Williamsport Riding Club

## Open Show #1

Trot Cross Rail Hunter (10 & Under & Novice)

Cross Rail Hunter (Jr. Youth & Sr. Youth)

3 7



2 6



60ft



72ft

4 8



1 5



Gate

Williamsport Riding Club  
Open Show #1  
Hunter Hack

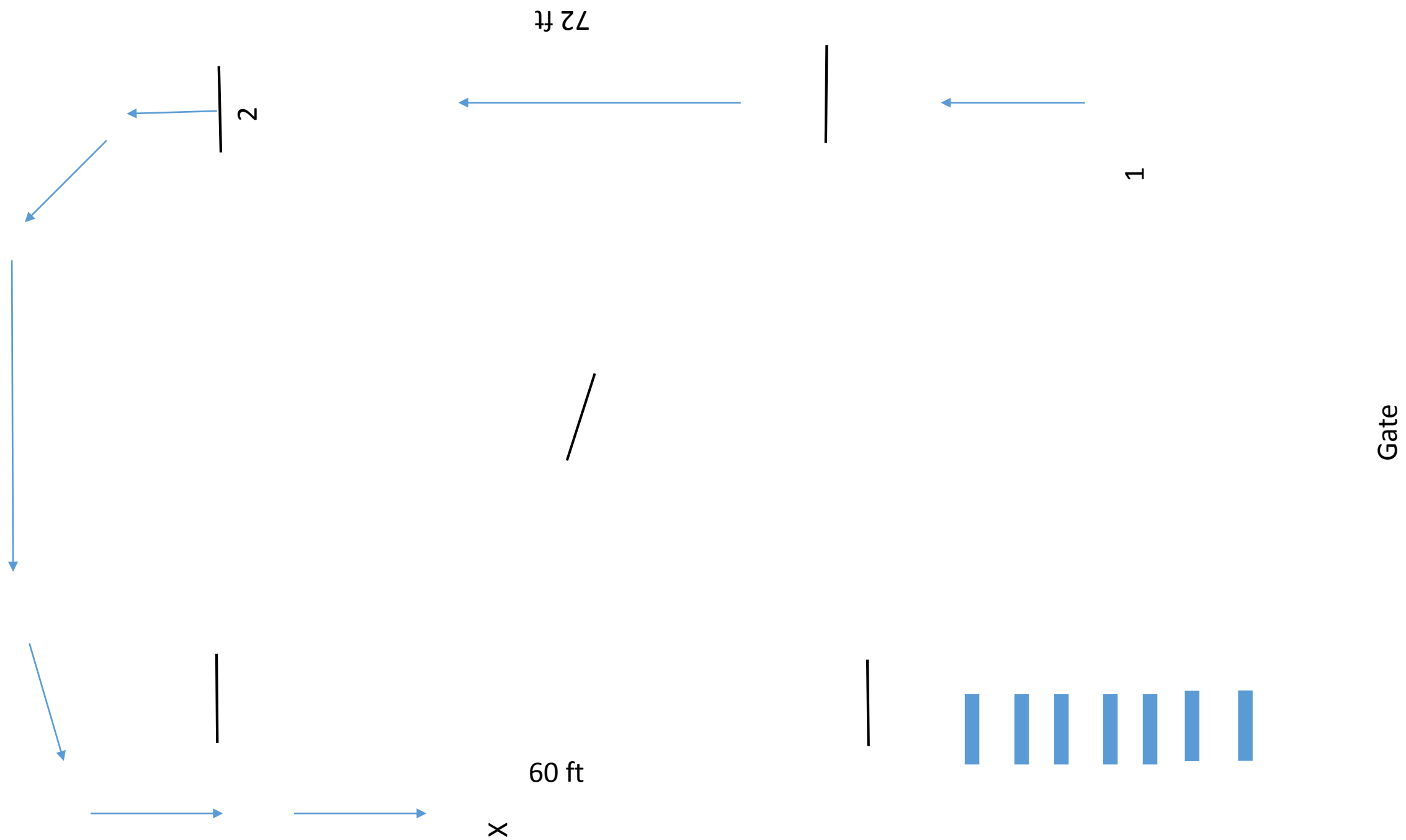

# Williamsport Riding Club

## Open Show #1

### Hunt Seat Equitation Over Fences

4  
—  
7

—  
3

8 1  
—

60 ft

72 ft

5  
—

—  
6 2

Gate



# Williamsport Riding Club

## Open Show #1

### Low Working Hunter Over Fences

6

---

2

---

5

60 ft

3



72 ft

7

---

1

---

4

Gate

Williamsport Riding Club  
Open Show #1  
Working Hunter Over Fences

6

---

---

5

1

---

60 ft

72 ft

3 7

---

---

4 2

Gate

# Showmanship Patterns

Williamsport Riding Club  
Open Show #1  
Therapeutic Showmanship

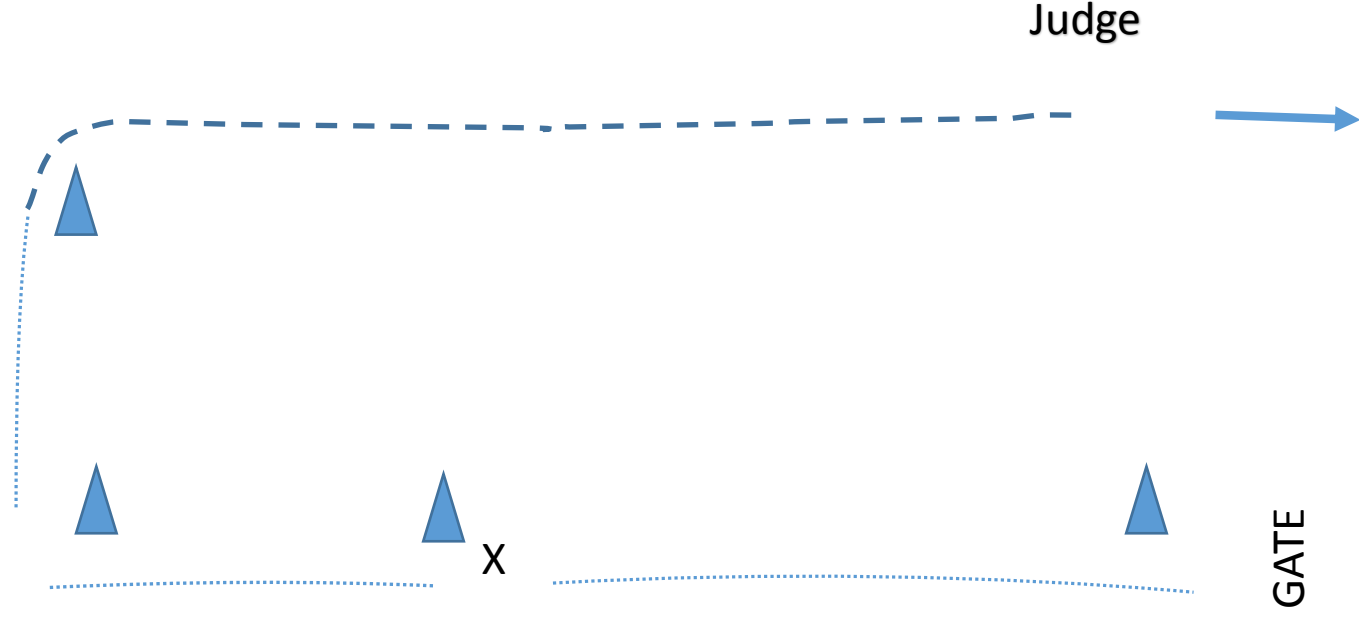

- Be ready at marker #1.
- Walk to marker #2.
- At marker #2 halt 5 seconds then walk to marker #3.
- At marker #3 trot to and around marker #4 and continue at a trot.
- Halt in front of the Judge. Present your horse for inspection.
- When dismissed exit the arena.

Williamsport Riding Club  
Open Show #1  
Showmanship  
Adult, Youth & Miniature Horse

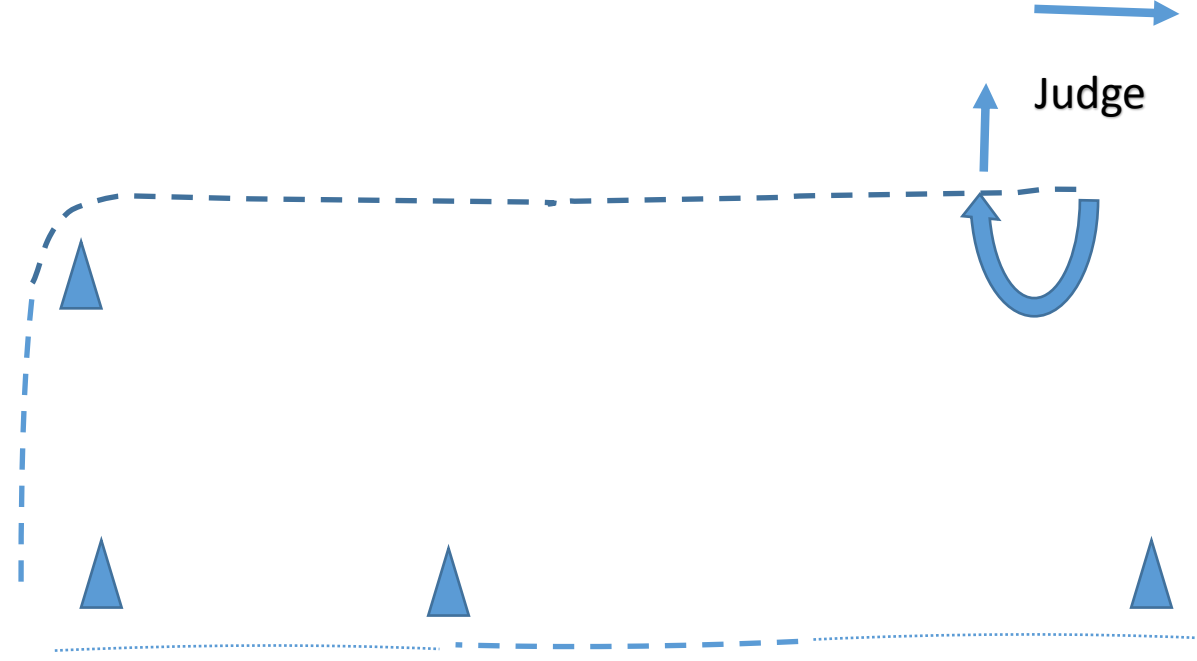

GATE

- Be ready at marker #1.
- Walk half way to second marker. Pick up a trot.
- Trot to marker #2.
- At marker #2 break to a walk and walk to marker #3.
- At marker #3 trot to and around marker #4 and continue at a trot.
- Halt in front of the Judge and turn 270° Present your horse for inspection. When dismissed exit the arena.

# Ranch Horse Patterns

Williamsport Riding Club  
Open Show #1  
Ranch Horse Horsemanship

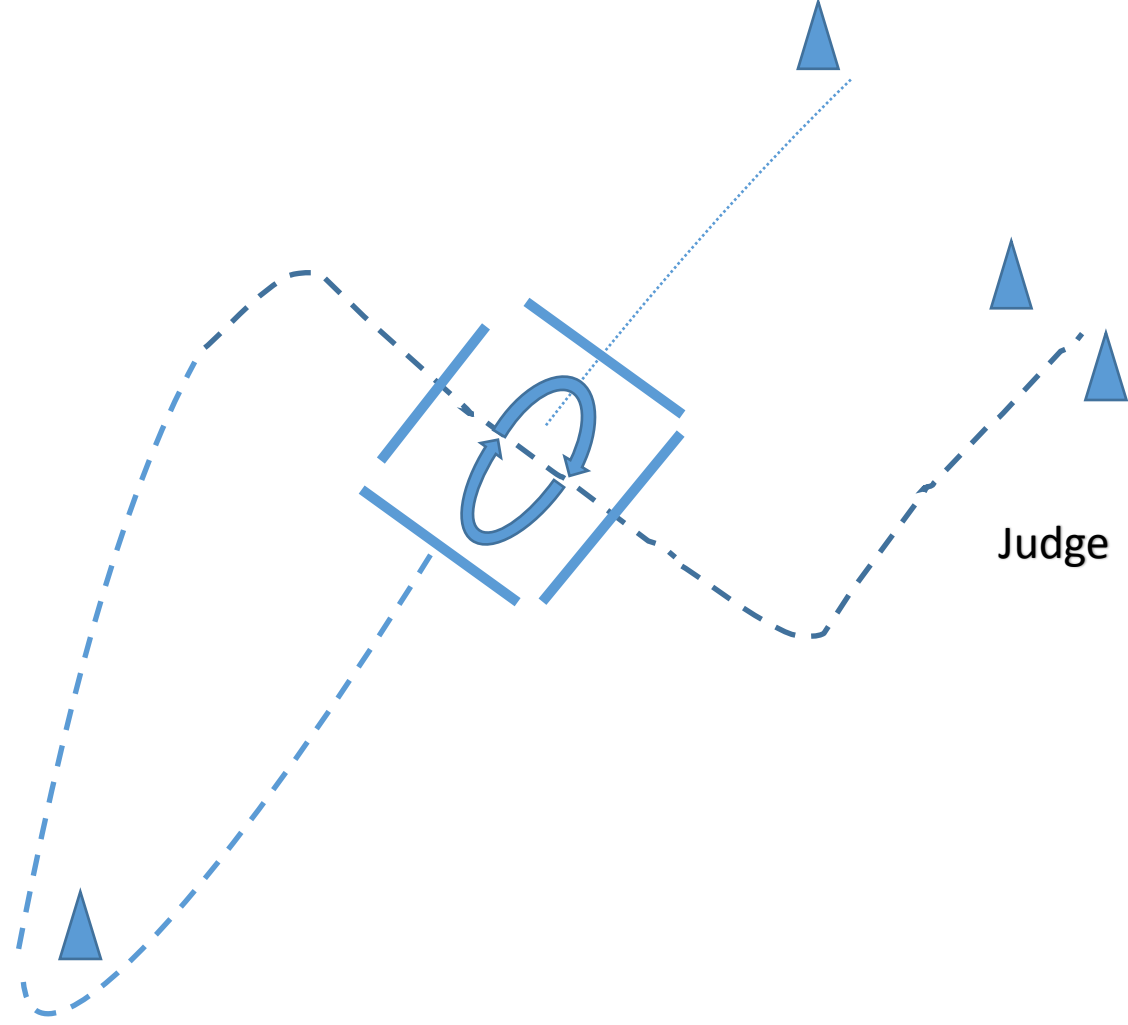

Be ready at marker #1.  
Walk into box perform a 360 ° turn in either direction.  
Then trot out of box around marker and trot through the box and exit  
between the two markers. Take a place on the rail.

GATE

# Sport Horse Patterns



Williamsport Riding Club  
Sport Horse In-Hand Halter  
(Modified Pattern)

Side 2 extended Trot

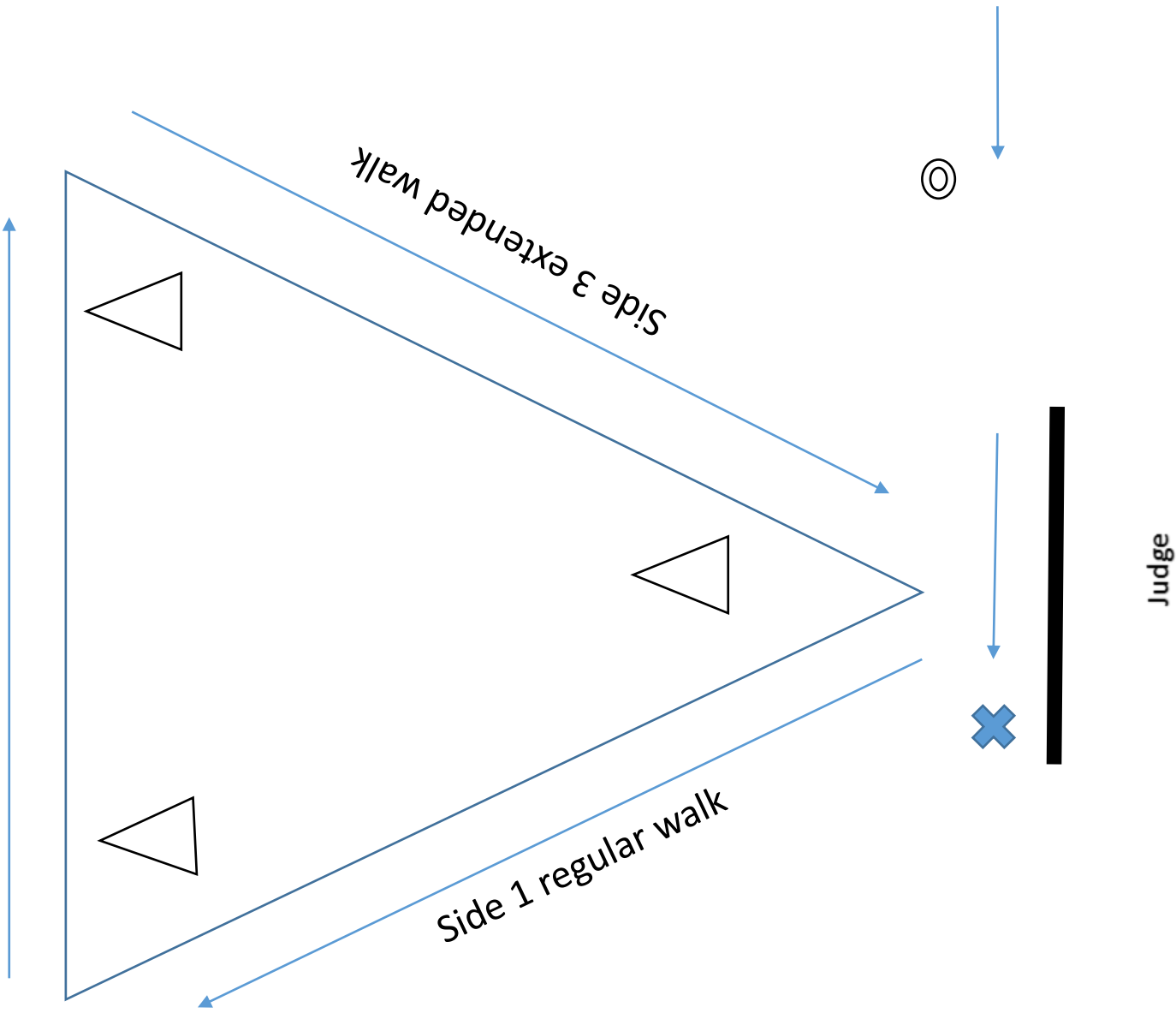

**Enter ring. Be ready at marker.**  
**Walk to X . Set up for inspection.**  
**Walk side 1 of triangle.**  
**Perform an extended trot side 2 of triangle.**  
**Perform an extended walk side 3 of triangle.**  
**Return to X . Exit ring when dismissed.**

Gate

Williamsport Riding Club  
Sport Horse In-Hand Showmanship

Side 2 Extended

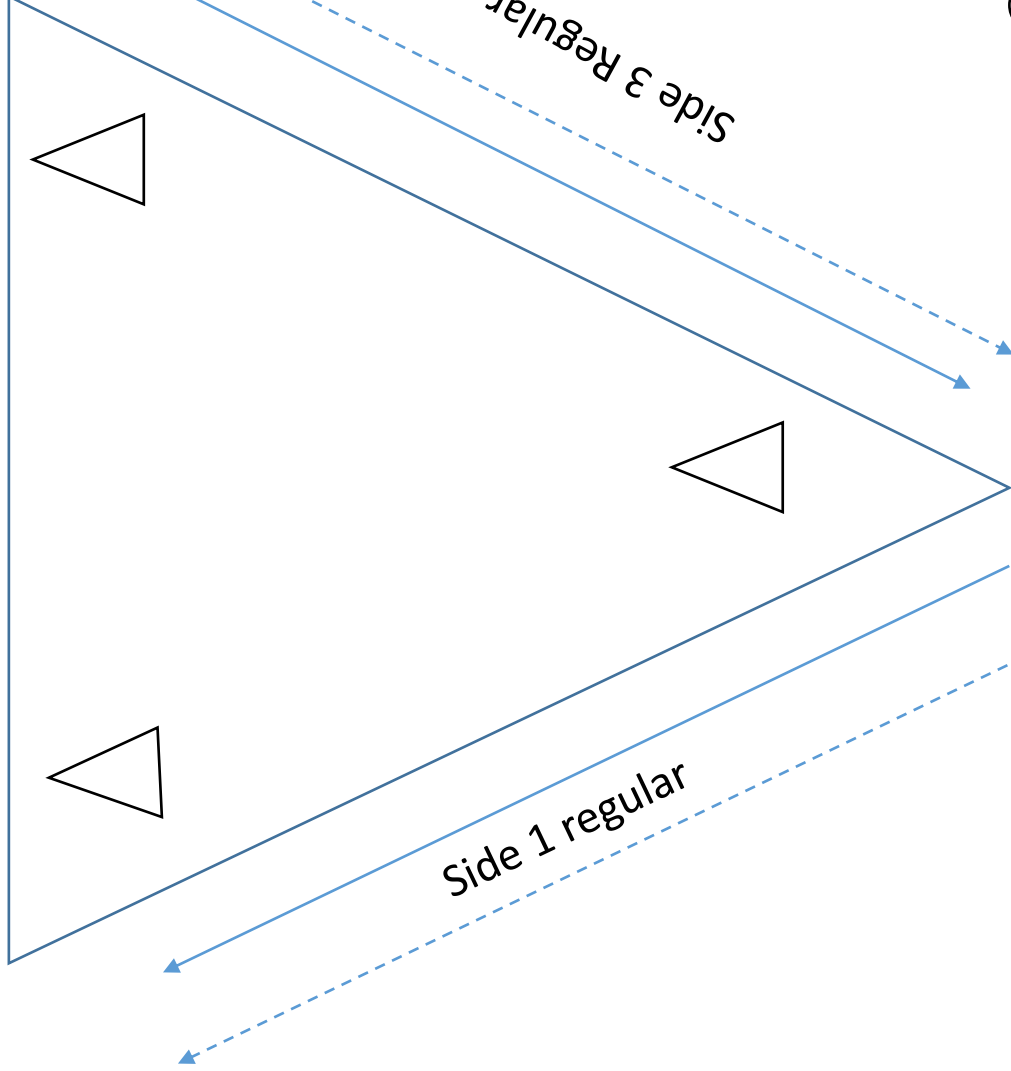

Side 1 regular

Side 3 Regular



Judge



**Enter ring. Be ready at marker.**

**Walk to X. Set up for inspection.**

**Walk side 1 of triangle.**

**Perform an extended walk side 2 of triangle.**

**Perform a regular walk side 3 of triangle.**

**Repeat triangle at a regular trot, extended trot and a regular trot.**

**Return to X. Exit ring when dismissed.**

Gate

# Miniature Horse Patterns

Williamsport Riding Club  
In-Hand Trail Course  
Miniature Horse

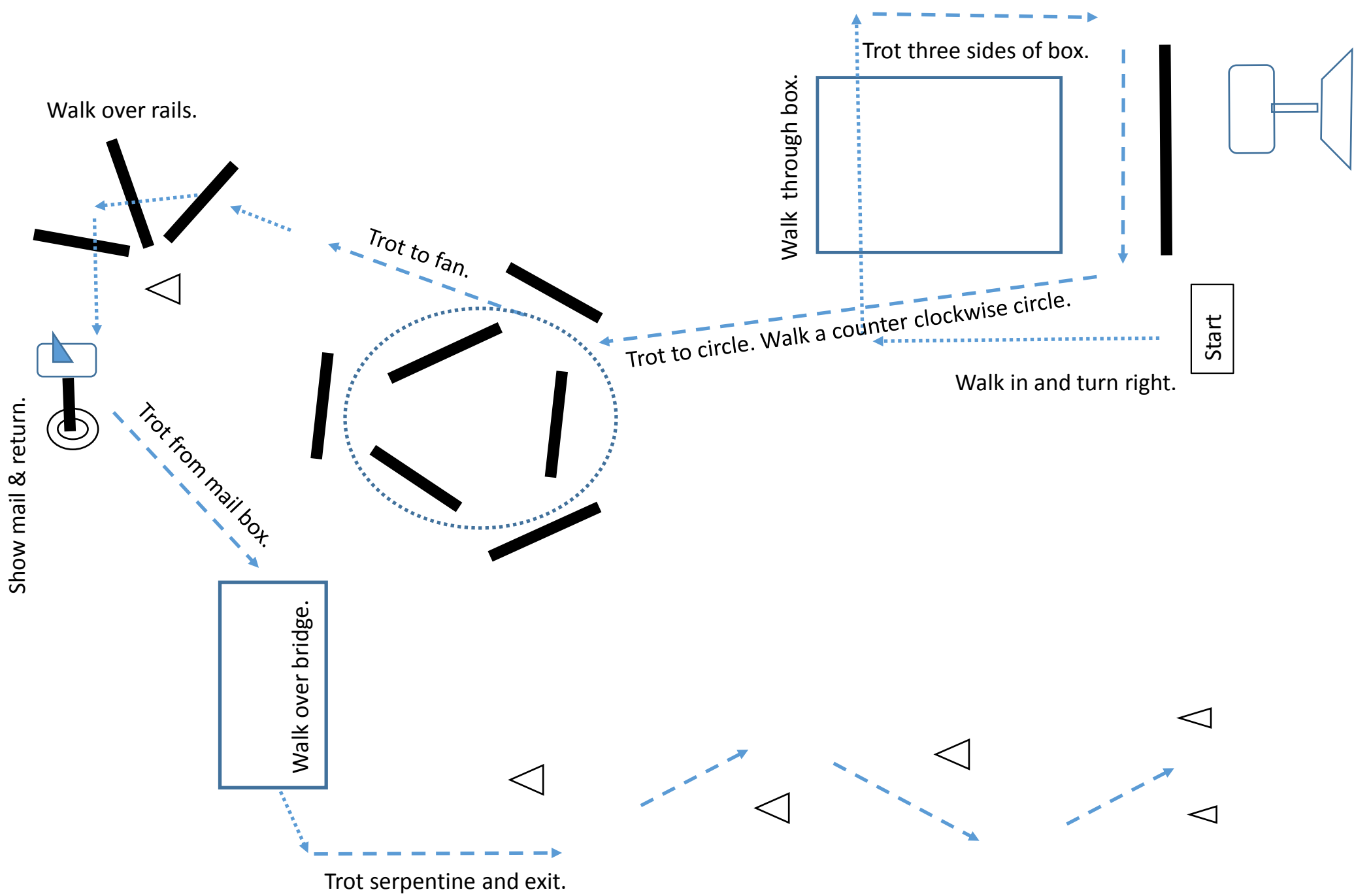

Sign in for order of go.

Williamsport Riding Club  
Ground Pole Course  
Miniature Horse

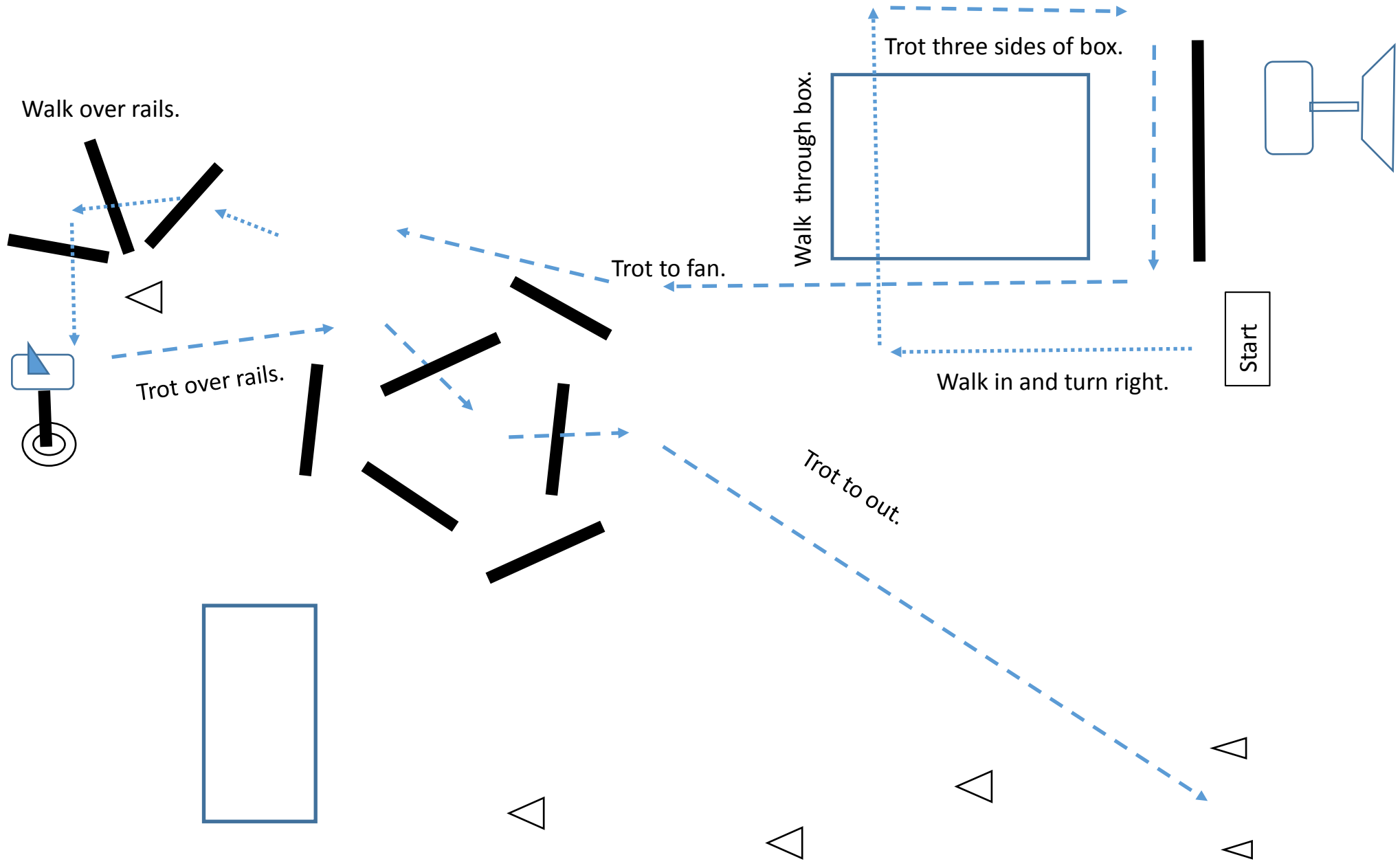

Sign in for order of go.



Williamsport Riding Club  
Open Show #1  
Miniature Horse Jumping Course A

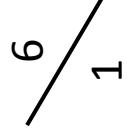
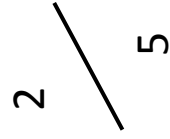

24 ft



Gate

Williamsport Riding Club  
Open Show #1  
Miniature Horse Jumping Course B

6 / 1

2 / 5

24 ft

4 /

3 /

Gate



# Trail & Ground Pole Courses

Williamsport Riding Club  
Trail Course  
Therapeutic

Show mail & return.

Walk over rails.

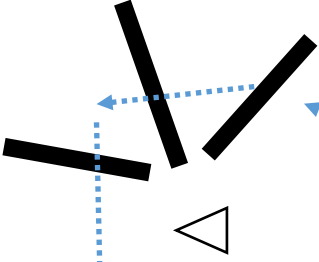

Trot to rails.

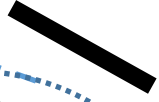

Trot to circle. Walk a counter clockwise circle.



Walk through box.



Trot three sides of box.

Walk in and turn right.

Start

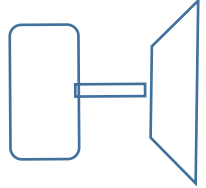

Walk over bridge.



Trot serpentine and exit.

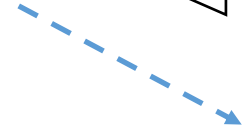

Sign in for order of go.

# WilliamSPORT Riding Club

## Trail Course

### Youth & Adult

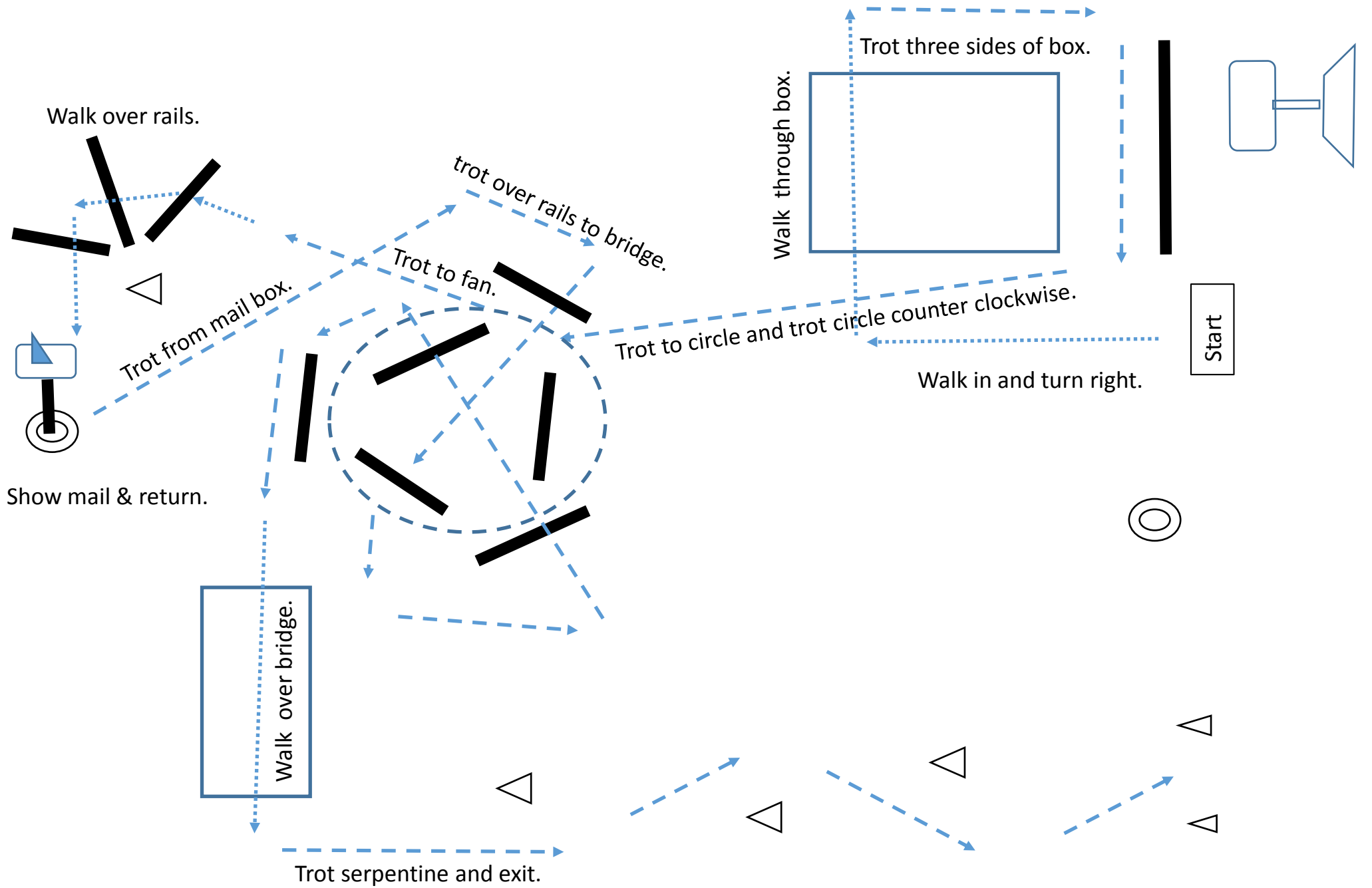

Williamsport Riding Club  
Ground Pole Course

Open

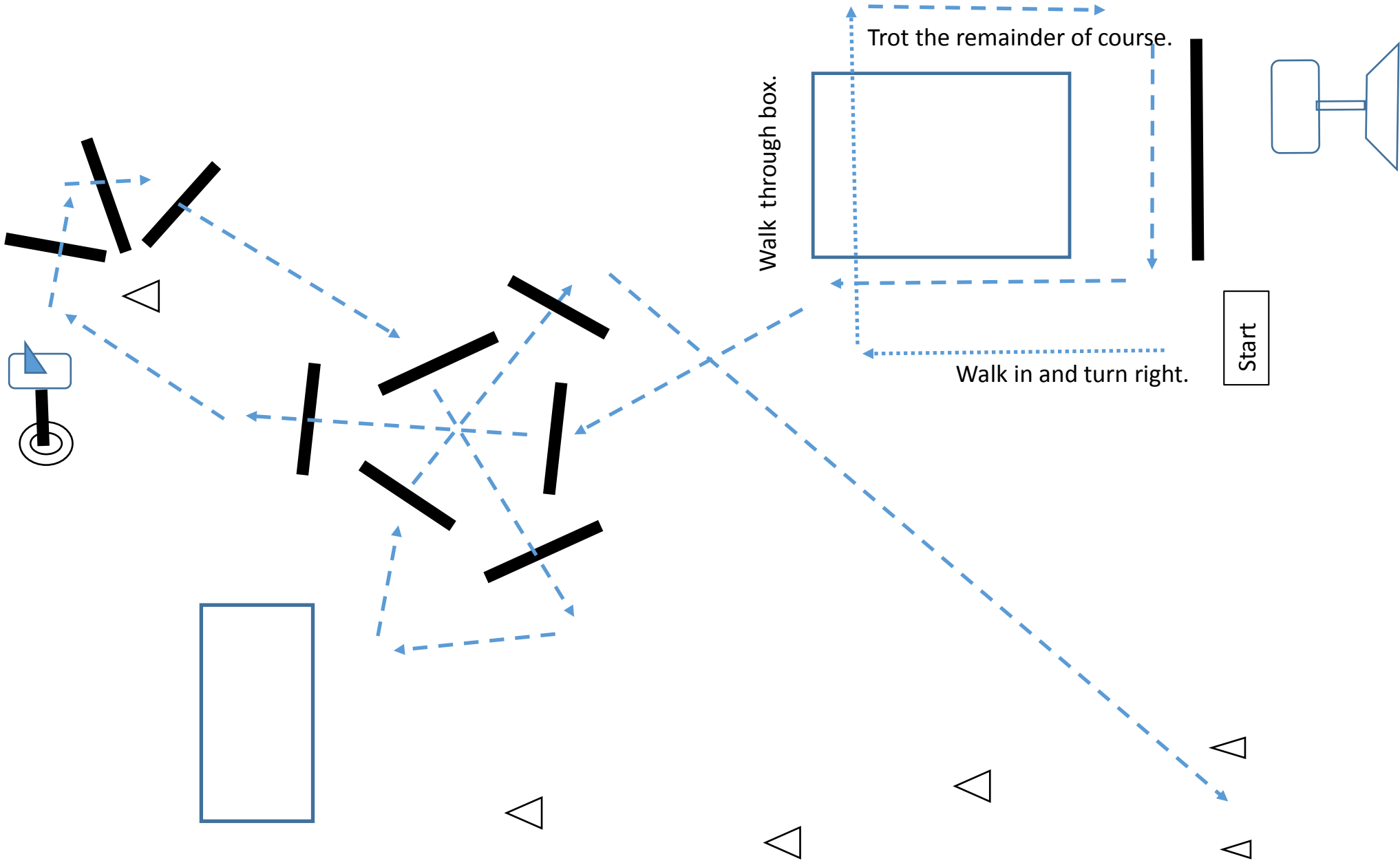

Sign in for order of go.

# Williamsport Riding Club In-Hand Trail Course

Open

