

Development of Thermoelectric Devices at Cardiff

- *Design, Fabrication and Evaluation* -

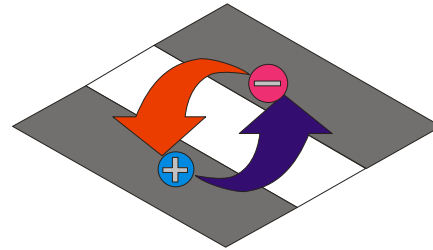

Gao Min

School of Engineering, Cardiff University



Thermoelectric Device Fabrication Processes

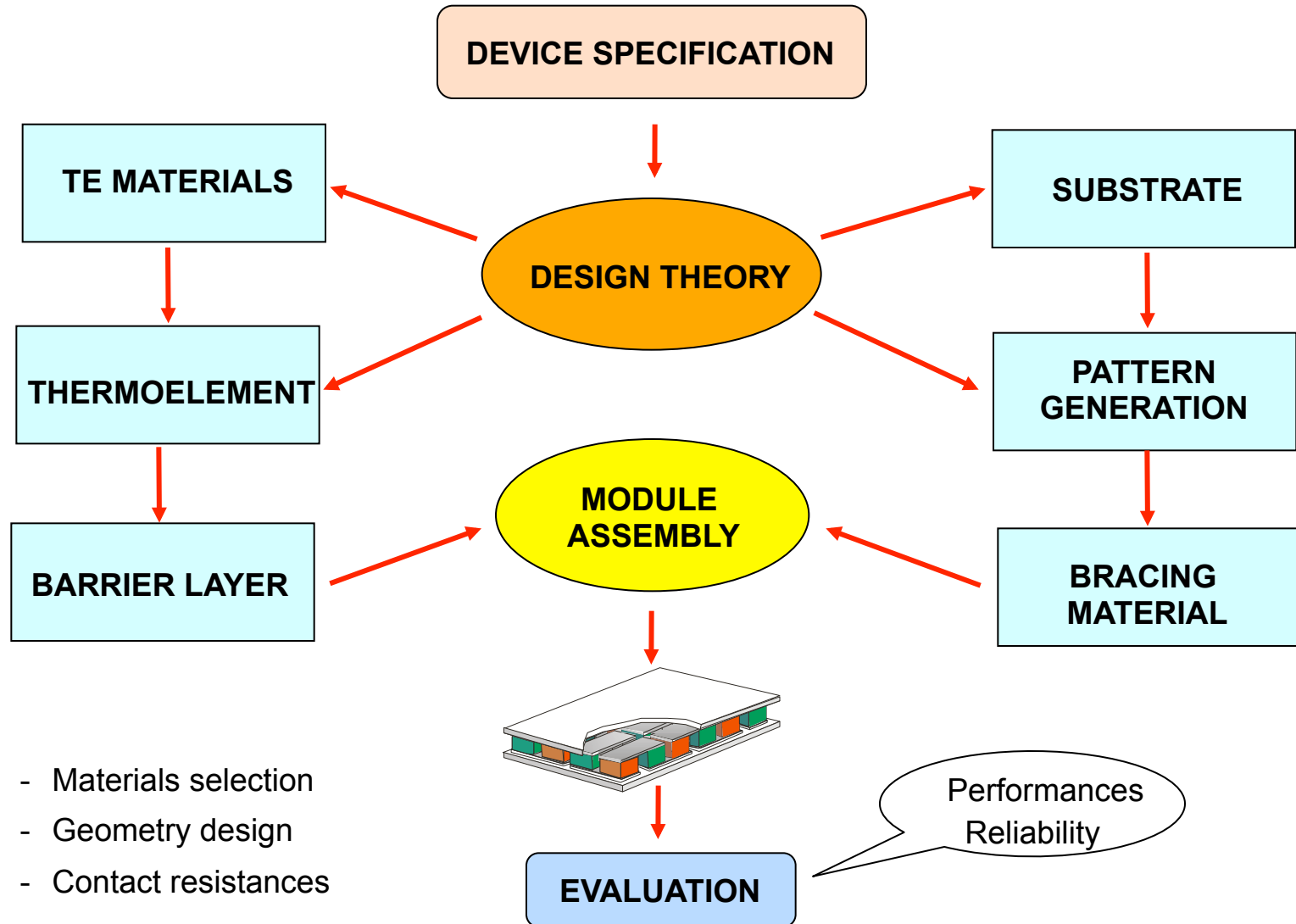

From Materials to Device – Contact problem

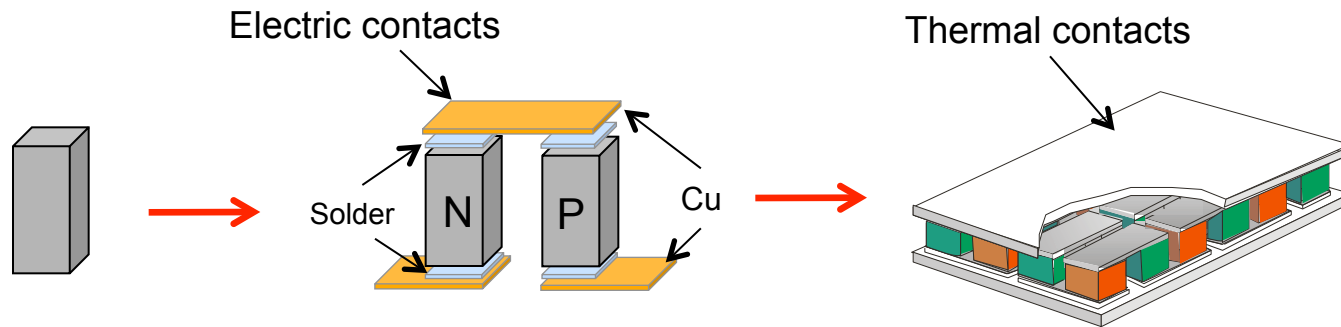

$$P_{\max} = \frac{(\alpha \cdot \Delta T)^2}{4\rho} \frac{A}{l}$$

$$\phi = \frac{\Delta T}{T_H \left(4 - \frac{\Delta T}{2T_H} + \frac{4}{ZT_H} \right)}$$

$$P_{\max} = \frac{(\alpha \cdot \Delta T)^2}{4\rho} \frac{A \cdot 2N}{(n+l)(1+2rl_c/l)^2}$$

$$\phi = \frac{\left(\frac{\Delta T}{T_H} \right)}{\left(1 + 2r \frac{l_c}{l} \right)^2 \left(2 - \frac{1}{2} \left[\frac{\Delta T}{T_H} \right] + \left[\frac{4}{ZT_H} \right] \left[\frac{l+n}{l+2rl_c} \right] \right)}$$

Module Design – Determine l for P_{max} or Φ_{max}

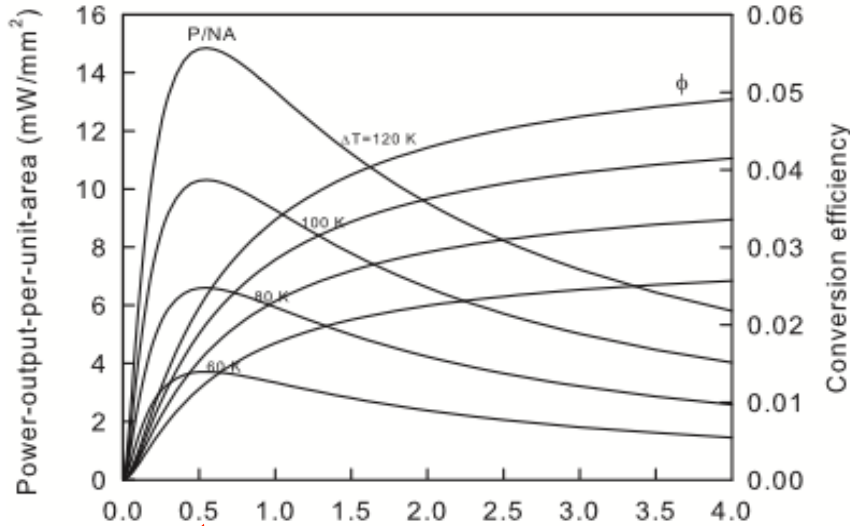
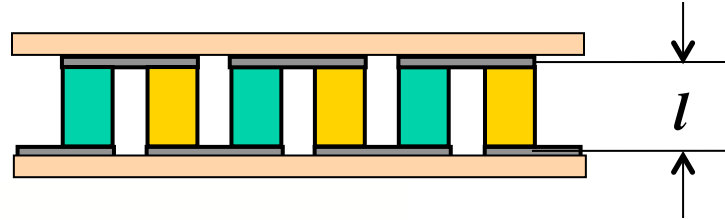

Thermoelement length (mm)

Optimal length for P_{max}

Preferred length for Φ_{max}

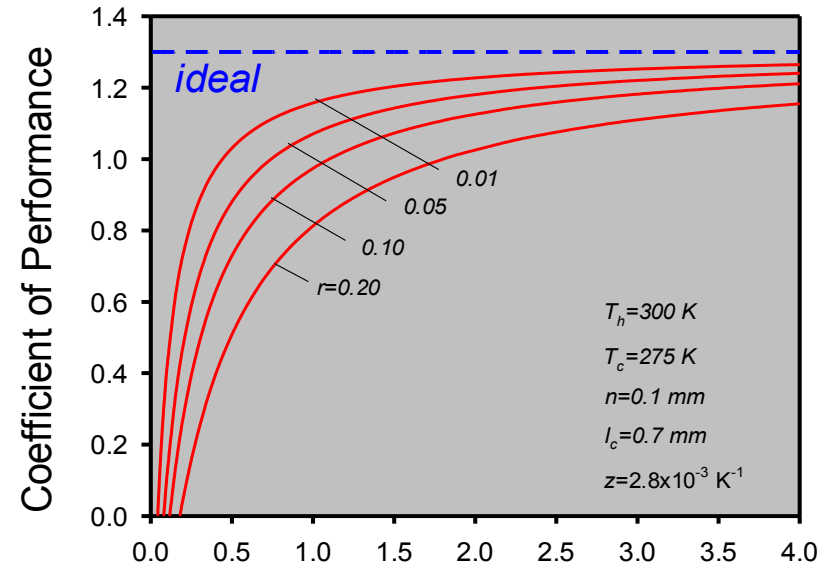

Thermoelement length (mm)

Reduce contact resistance helps to improve performance of short length

Module Design for Waste Heat Recovery

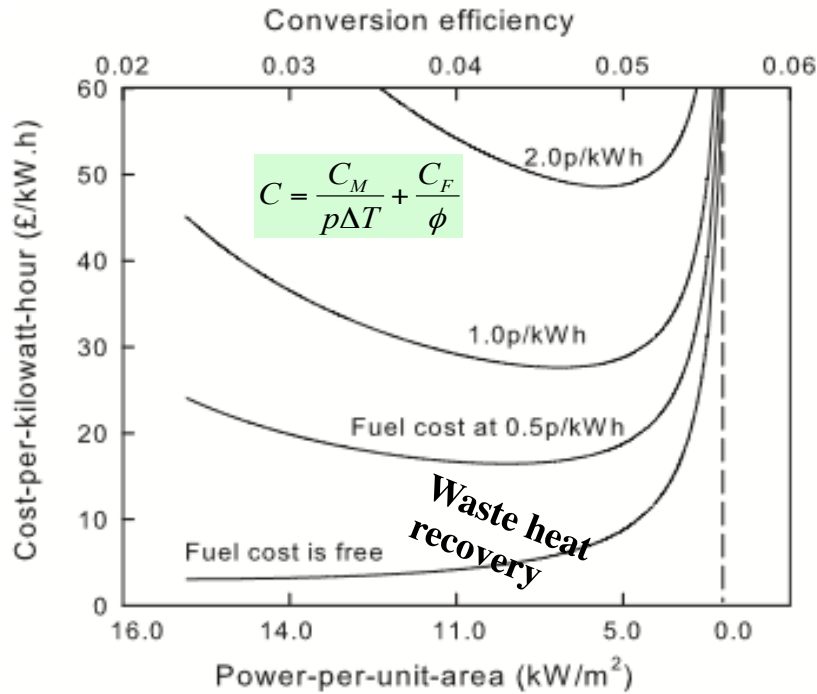

Suitable for waste heat recovery

Increasing the power output will lead to reduce the cost of power per module

The power output can be increased by reducing the length of thermoelements.

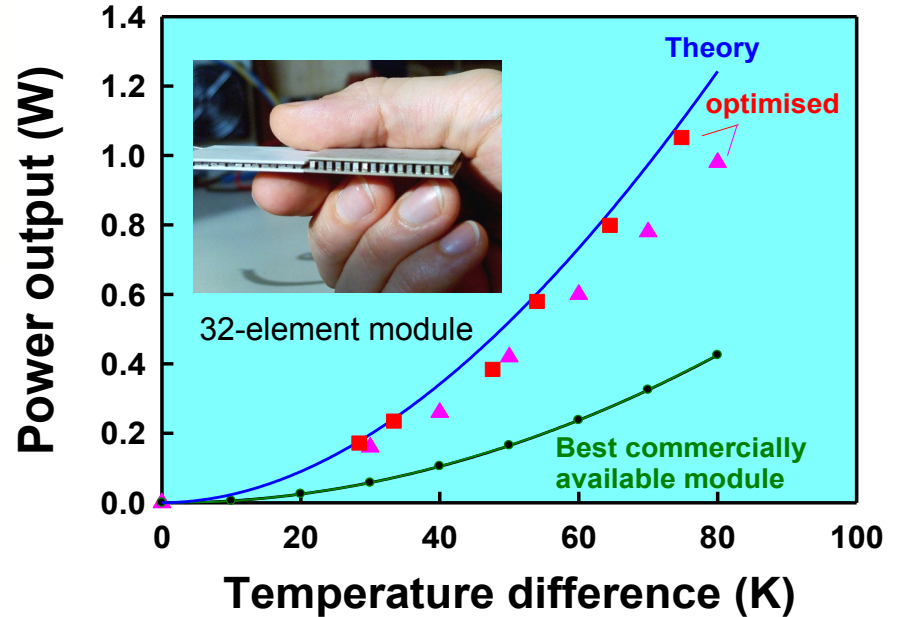

Module Design Theory for Given Thermal Input

$$\Delta T_c = \frac{\Delta T_o}{1 + ZT_M}$$

$$T_M = \frac{(1 + 2s)T_H + T_C}{2(1 + s)^2}$$

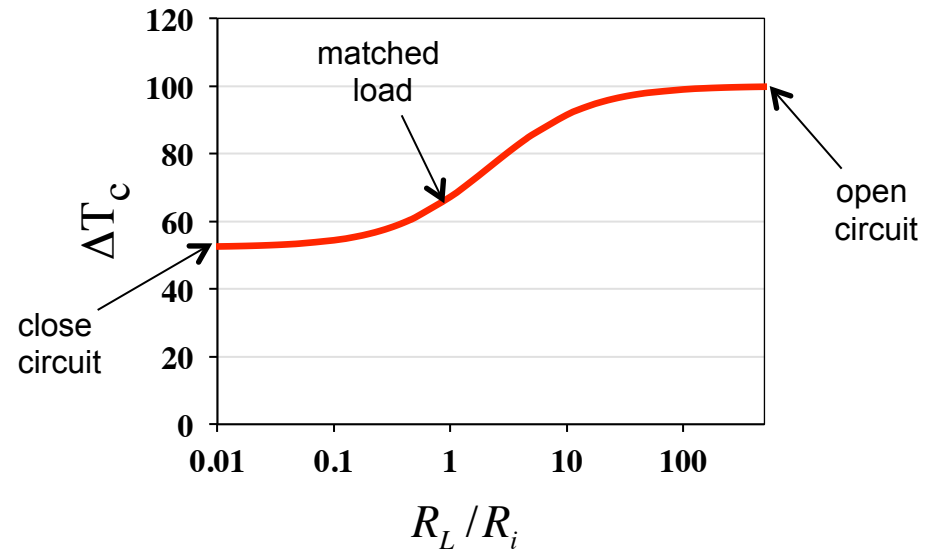

Power output:
$$P = \frac{s}{(1 + s)^2} \cdot \frac{Z}{(1 + ZT_M)^2} \cdot \frac{\dot{Q}^2}{\lambda} \cdot \frac{l}{A} \cdot \frac{l}{(n + l)(1 + 2rl_c/l)^2}$$

Efficiency:
$$\phi = \frac{P}{\dot{Q}} = \frac{s}{(1 + s)^2} \cdot \frac{Z}{(1 + ZT_M)^2} \cdot \frac{\dot{Q}}{\lambda} \cdot \frac{l}{A} \cdot \frac{l}{(n + l)(1 + 2rl_c/l)^2}$$

Geometry Optimisation for Given Thermal Input

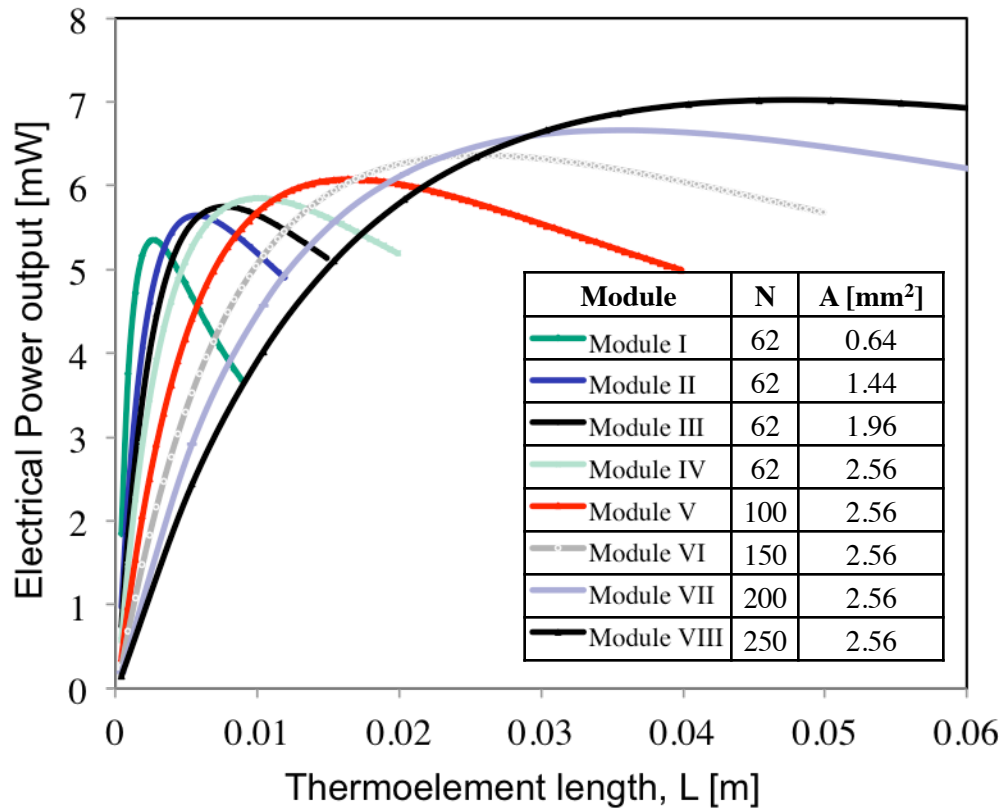

Solar irradiation: 1000W/m²

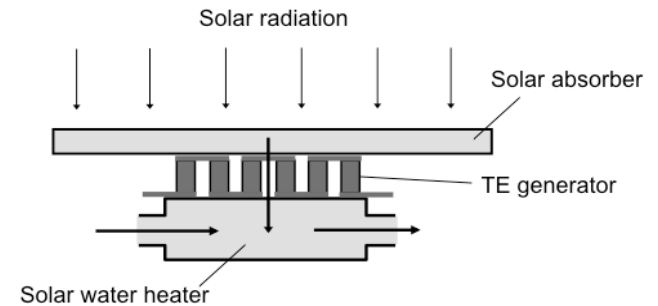

Solar absorber area: 4cm x 4cm

Material Consumption:

Module	Power (mW)	Volume (cm ³)
I	5.2	0.23
VIII	7.0	57.6

Techniques for Evaluation of Contact Resistance

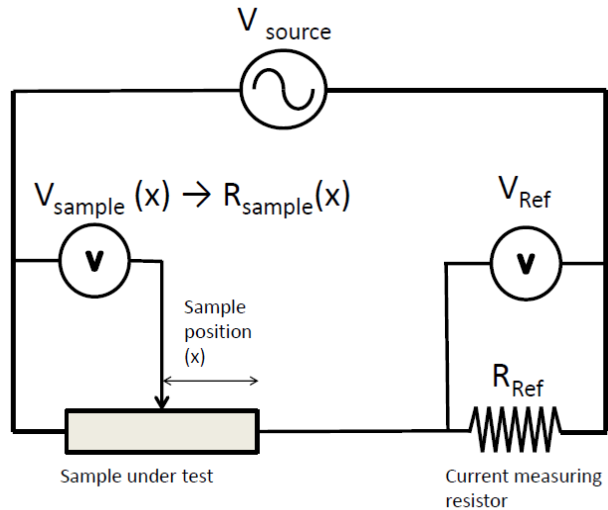

$$R(x) = \frac{V_S(x)}{V_{ref}} \cdot R_{ref}$$

$$\rho_c = \Delta R \cdot A$$

$$\rho = dR(x) / dx$$

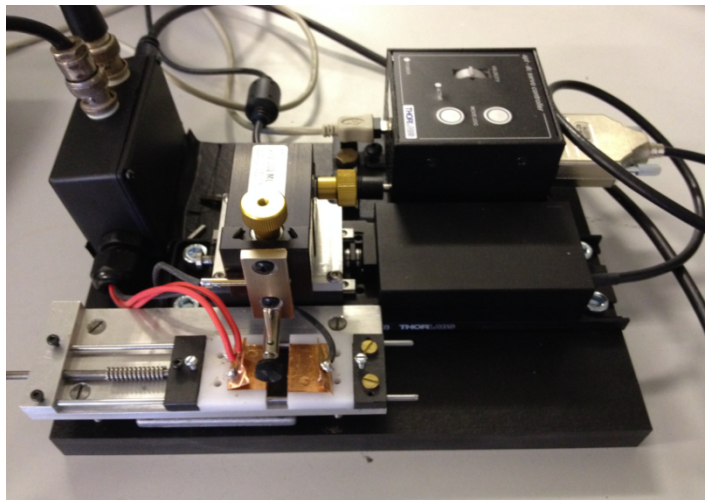

Spatial resolution: 5 μ m

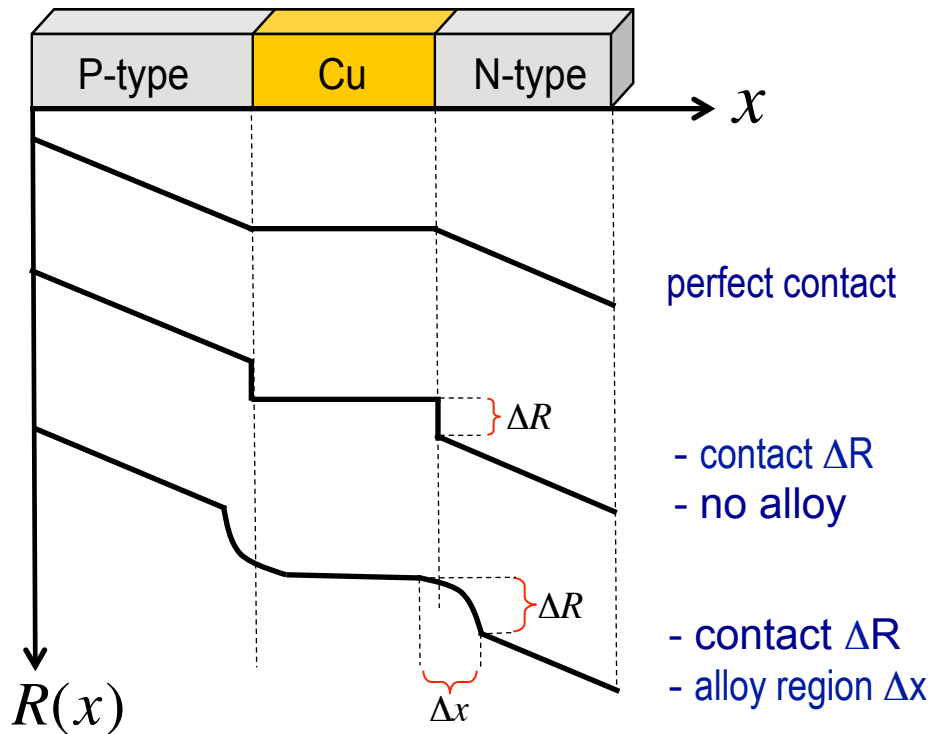

Contact Resistance of Skutterudite interfaces

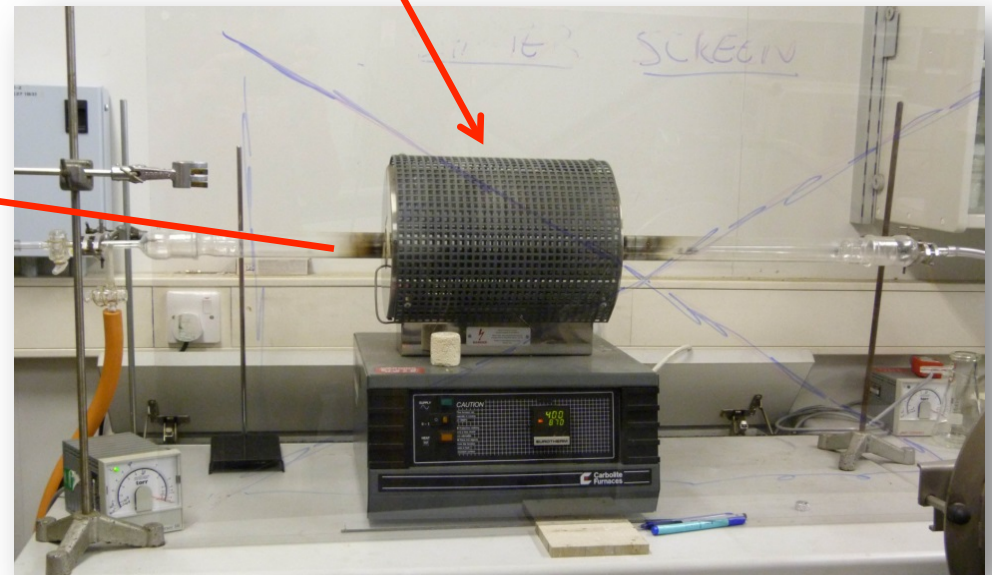
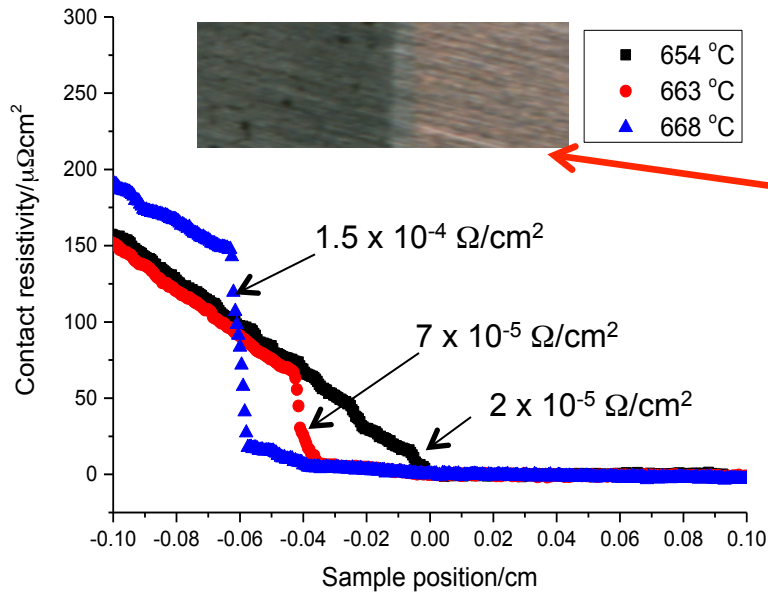
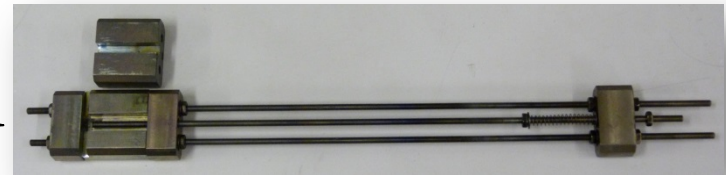
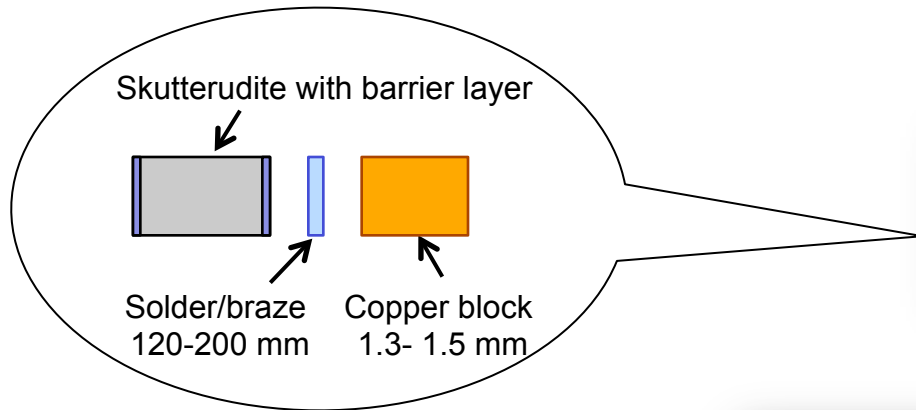

Investigate Thermal Contact Effect Using Infrared Microscope

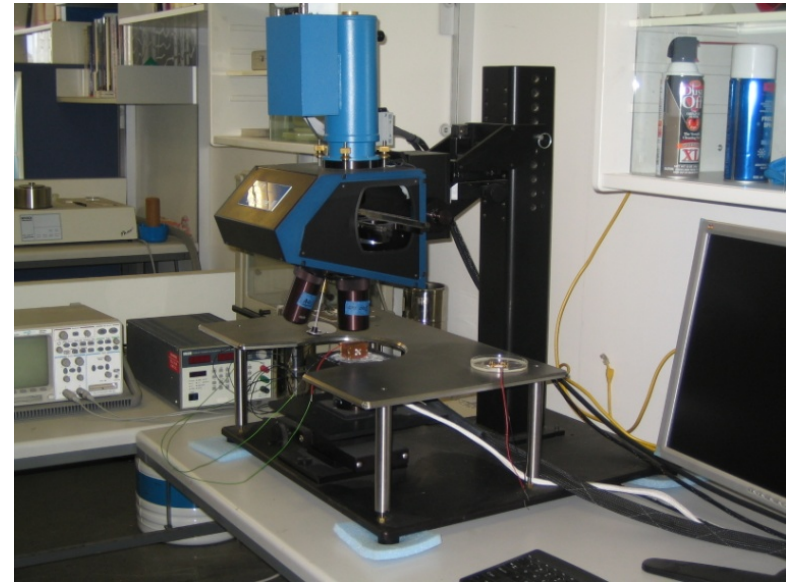
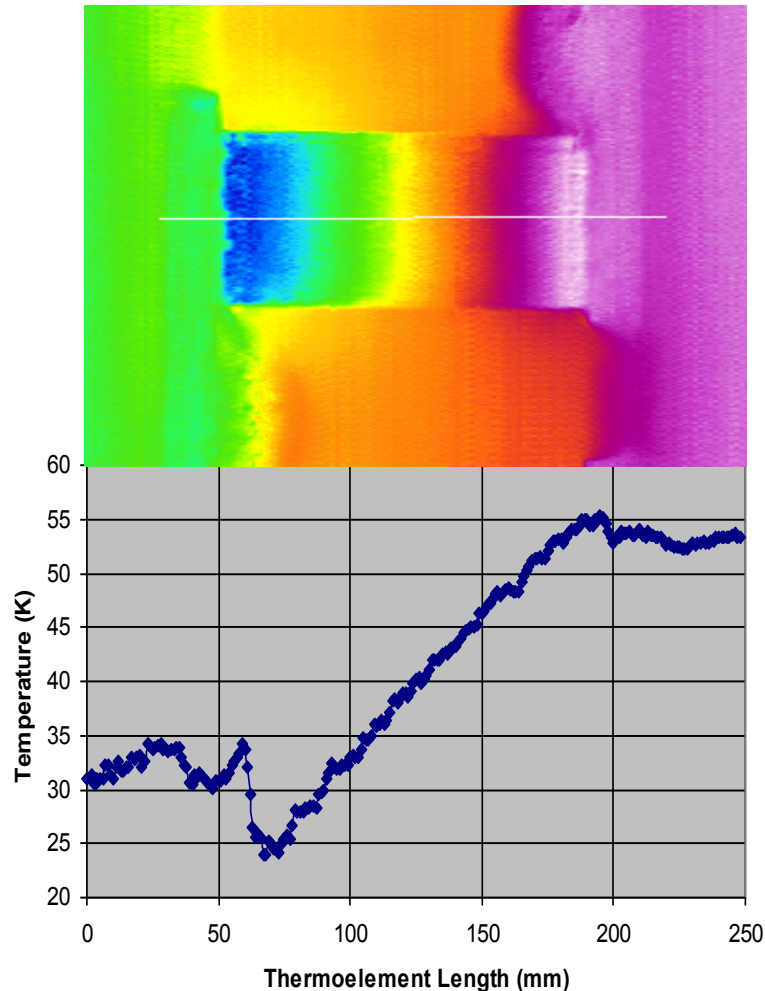

Specifications:

- Spatial resolution: $4 \mu\text{m}$
- Temperature sensitivity: 0.1 K
- Temperature range: $300\text{-}600\text{K}$

Fabrication of High Temperature Skutterudite Module

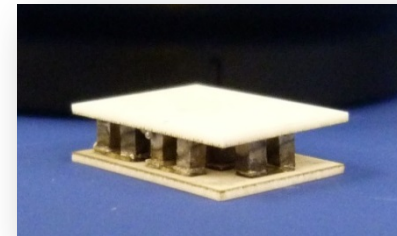
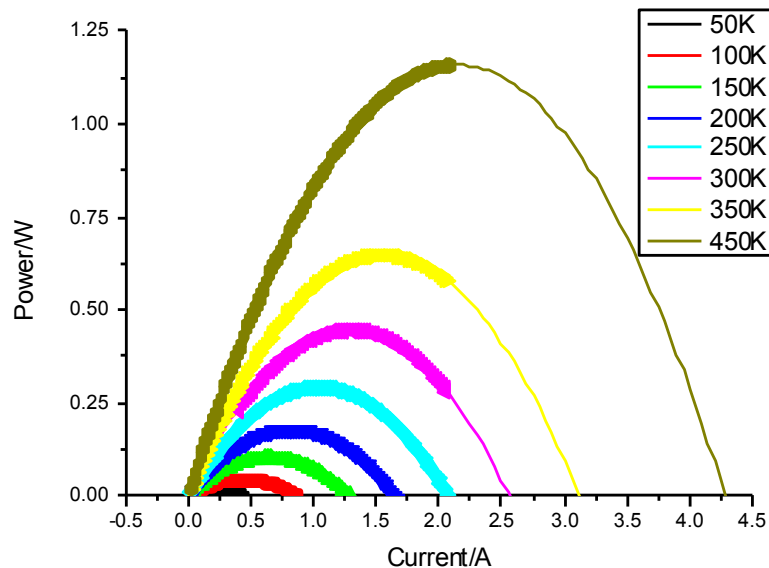
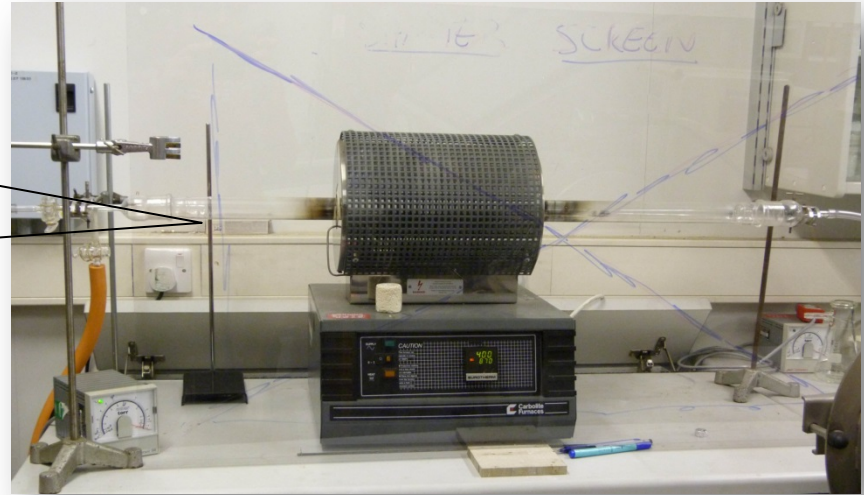
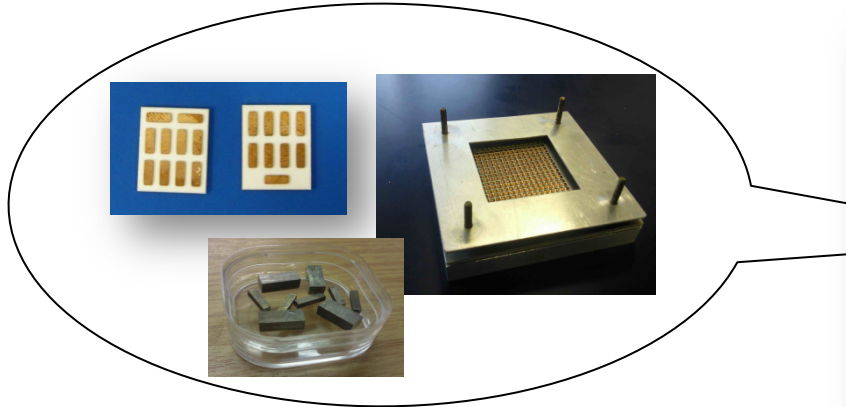

Loughborough-Reading-Cardiff Collaboration

Ring-structured Thermoelectric Module

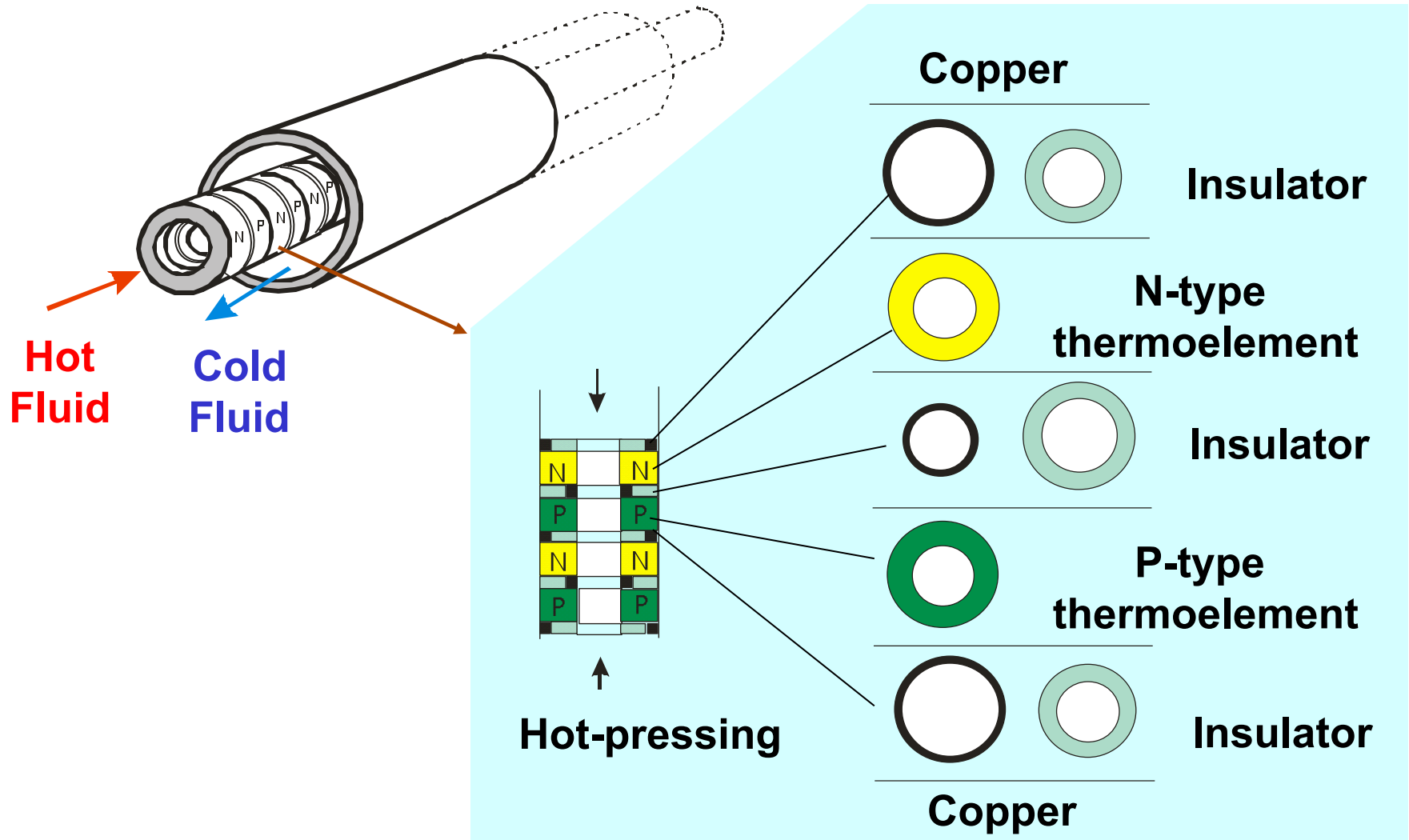

Ring-Structured Thermoelectric Tube

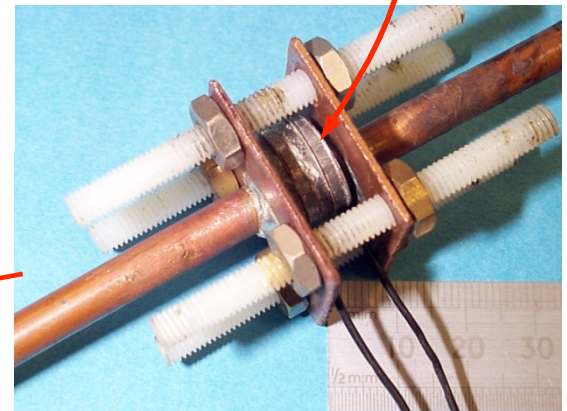
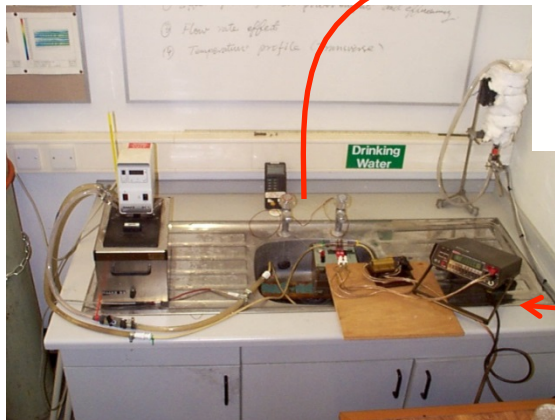
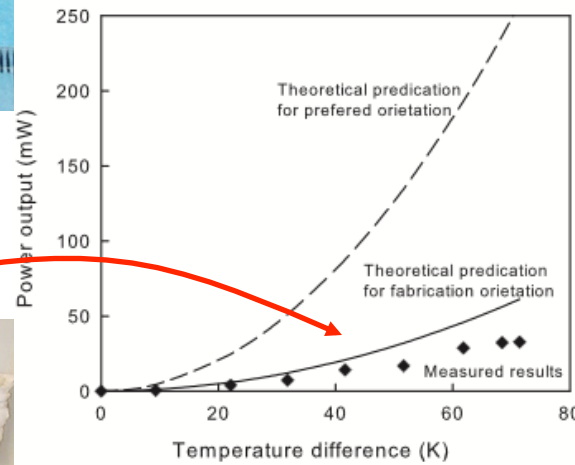
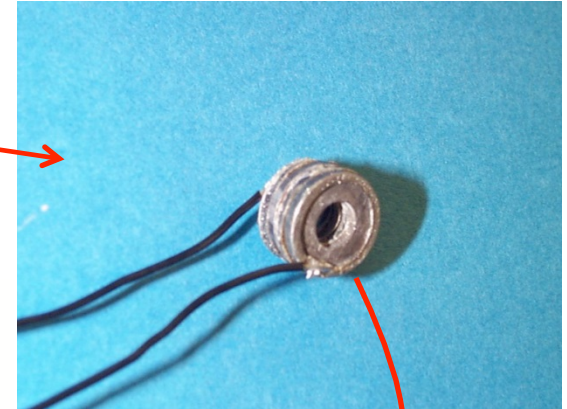

Micro/Nano Converters for Integrated Circuits

Horizontal structure

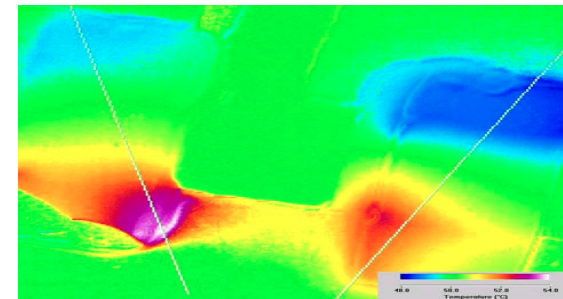
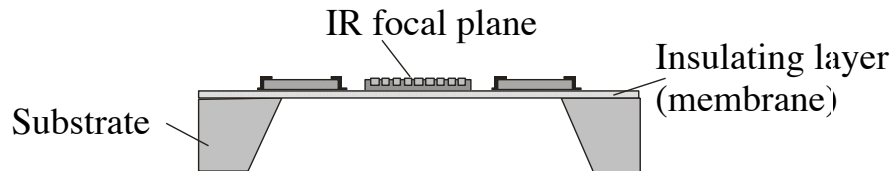
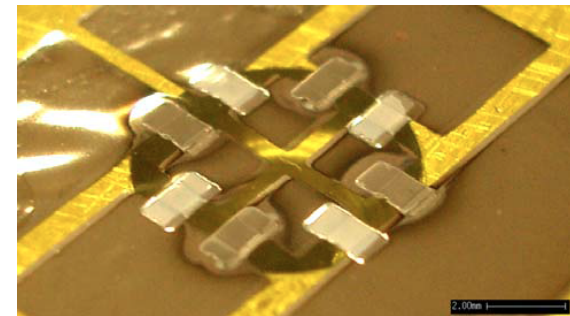
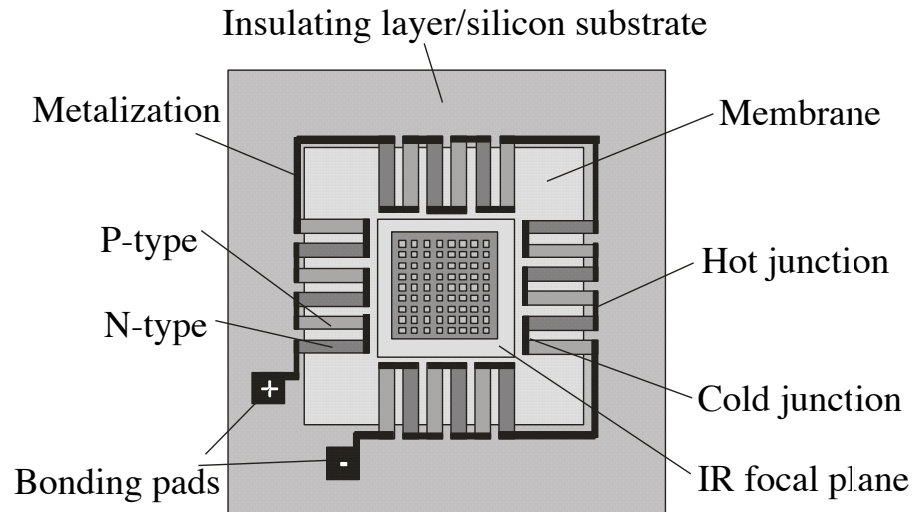
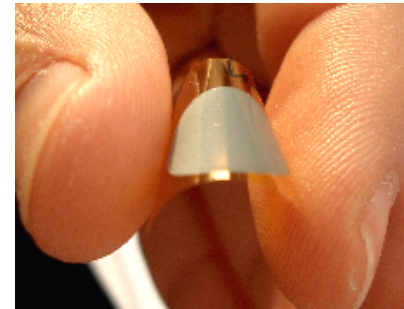

Ref: G Min and D Rowe, Electronics Letter, 1998, 34(2), 222-223

L.M. Goncalves, P. Alpuim, G. Min, D. M. Rowe, C. Couto, and J. H. Correia, "Optimization of Bi₂Te₃ and Sb₂Te₃ thin films deposited by co-evaporation on polyimide for thermoelectric applications", Vacuum, 82 (12), (2008), 1499-1502

Evaluation of TE Generators by I-V Curves

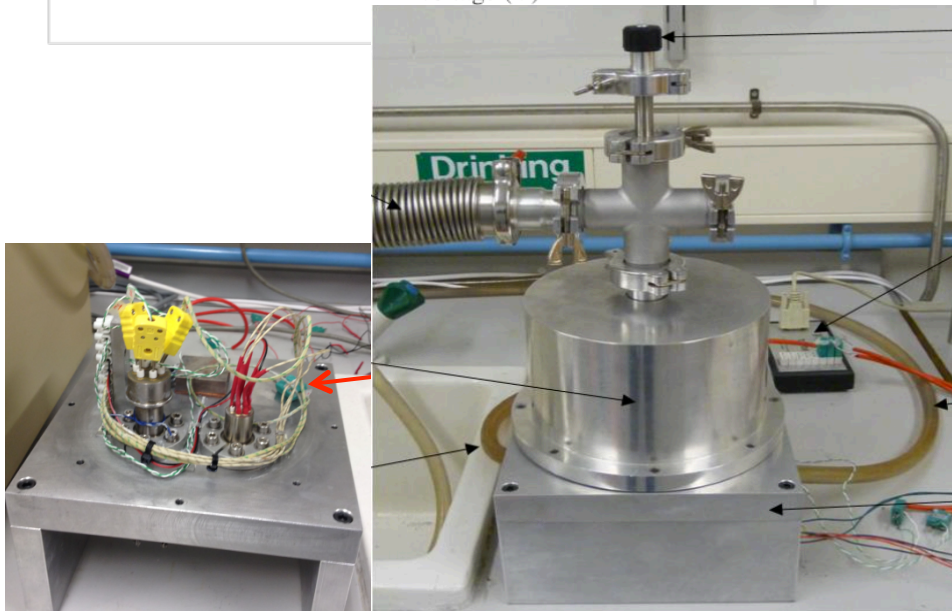
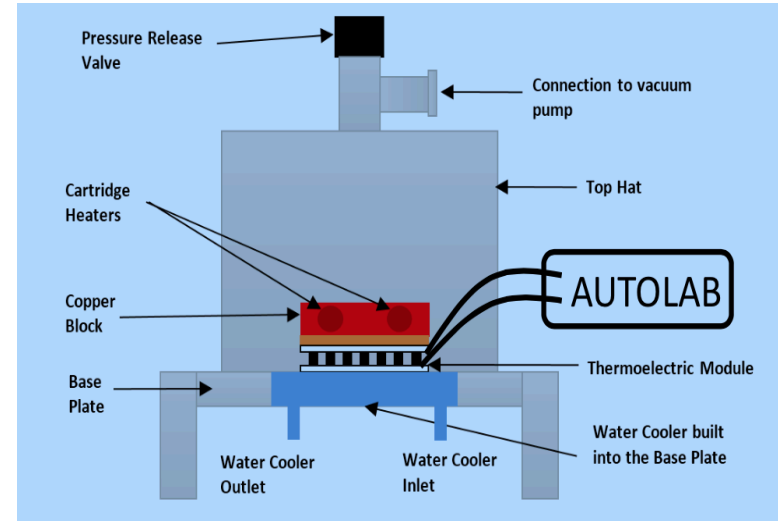
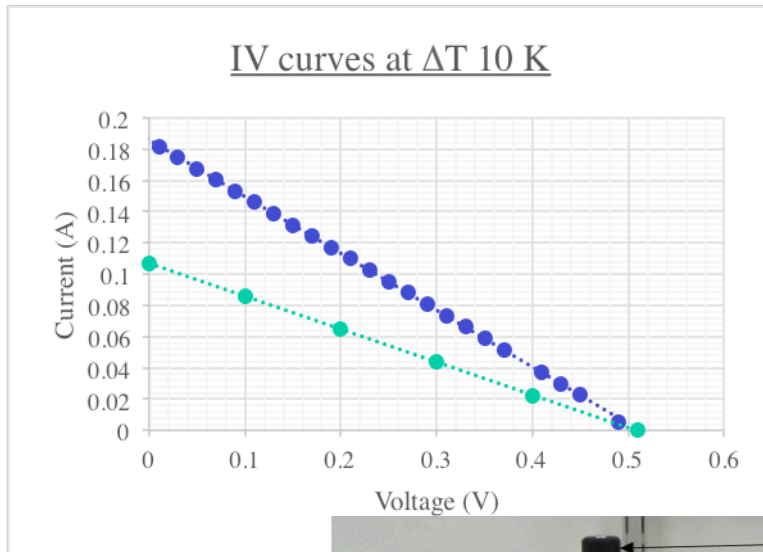

The use of AUTOLAB eliminates requirements for sophisticated temperature control system.



Thermoelectric Parameters Obtainable from I-V Curves

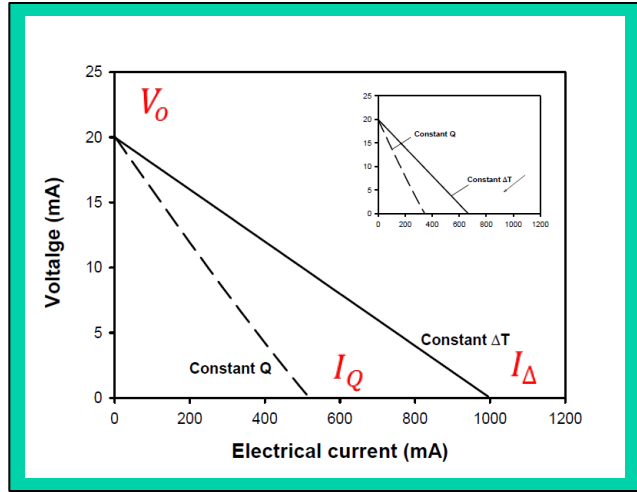

Generator performances

$$P_{\max} = \frac{1}{4} \cdot I_Q \cdot V_o$$

$$\eta_{\max} = \frac{1}{4} \cdot \frac{\Delta T_o}{\bar{T}} \cdot \left(1 - \frac{I_Q}{I_\Delta}\right)$$

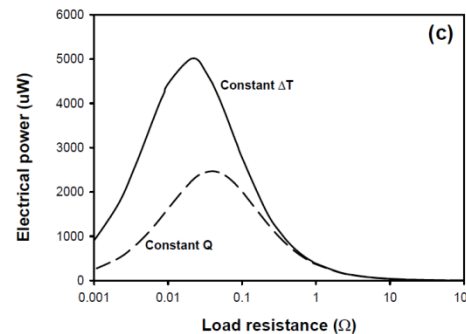
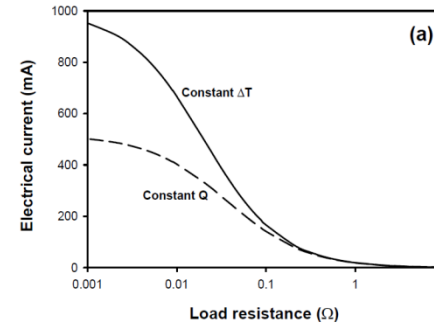
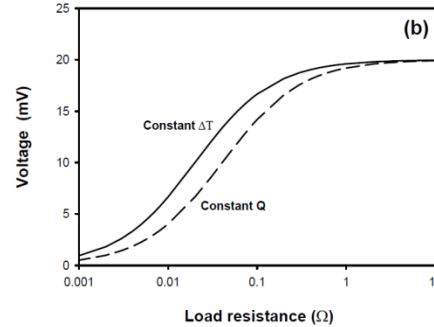

Device parameters

$$Z\bar{T} = \frac{I_\Delta}{I_Q} - 1$$

$$\alpha = \frac{V_o}{\Delta T_o}$$

$$R_i = \frac{V_o}{I_\Delta}$$

$$K = \frac{\bar{T}}{\Delta T_o^2} \cdot \frac{I_Q \cdot V_o}{1 - I_Q / I_\Delta}$$

$$\rho = \frac{A}{l} \cdot R_i \quad \lambda = \frac{l}{A} \cdot K$$

Thermoelectric Impedance Spectroscopy

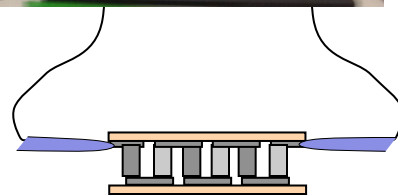
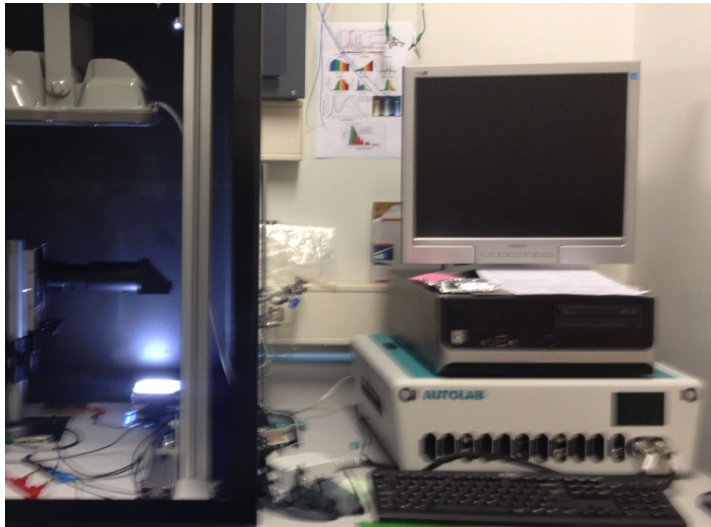

$$ZT = \frac{R_{TE}}{R_i}$$

TE
module

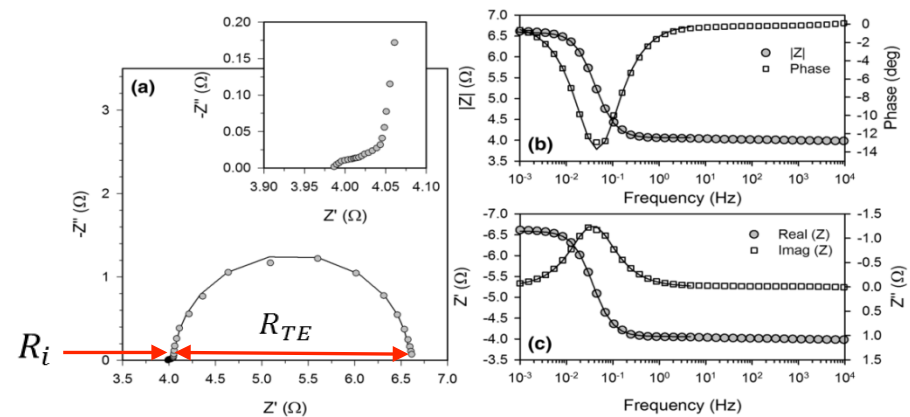
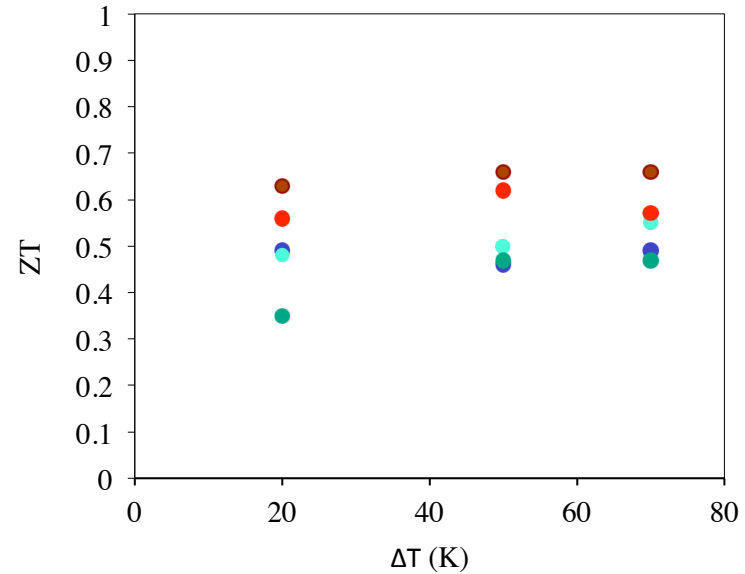

Influence of Thermal Contact Materials

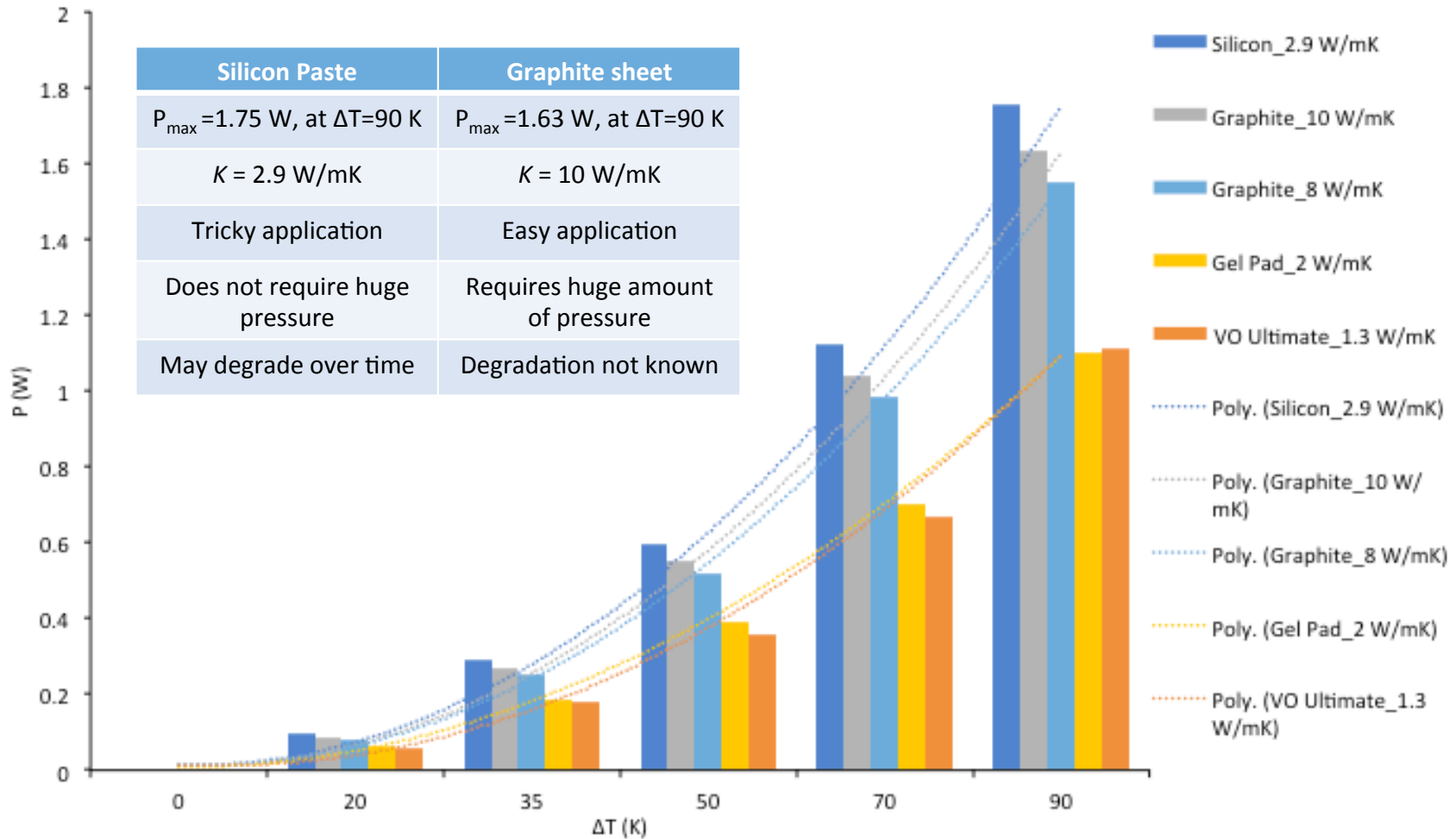

Thank You

Acknowledgement

- Matthew Philips
- Jorge G Canadas
- Tanuj Singh
- Jay Bompfrey
- Lourdes M Garcia
- Hasan Hashim
- Martin Prest
- Tracy Sweet
- Mark Robbins
- Matesuz Augustyniak
- W M N WanJaafar
- Hayder Al-Madhachi
- M Al-Bagdadi
- Nadhrad Yatim
- Ramdan Kazuz
- EU-FP7 THERELEXPRO (601545)
- EU-FP7 GLOBASOL (309194)
- EU-FP7 ACCMET (263206)
- EPSRC UKTEG (EP/K029142)
- EPSRC SUNTRAP (EP/K022156)