

CREW CAB 2500 149.5"WB SRW 4X2 SPRING SUSPENSION

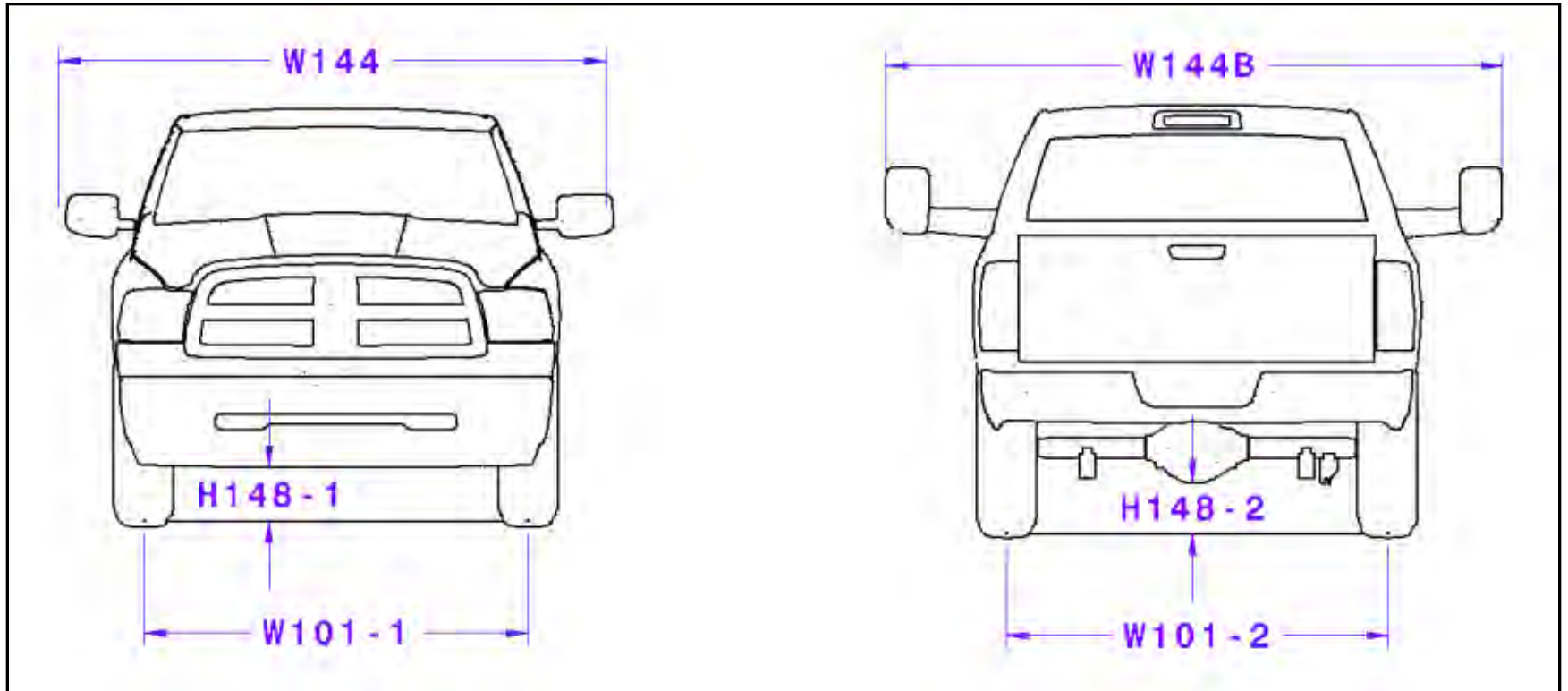

CREW CAB 2500 149.5"WB SRW 4X2 SPRING SUSPENSION

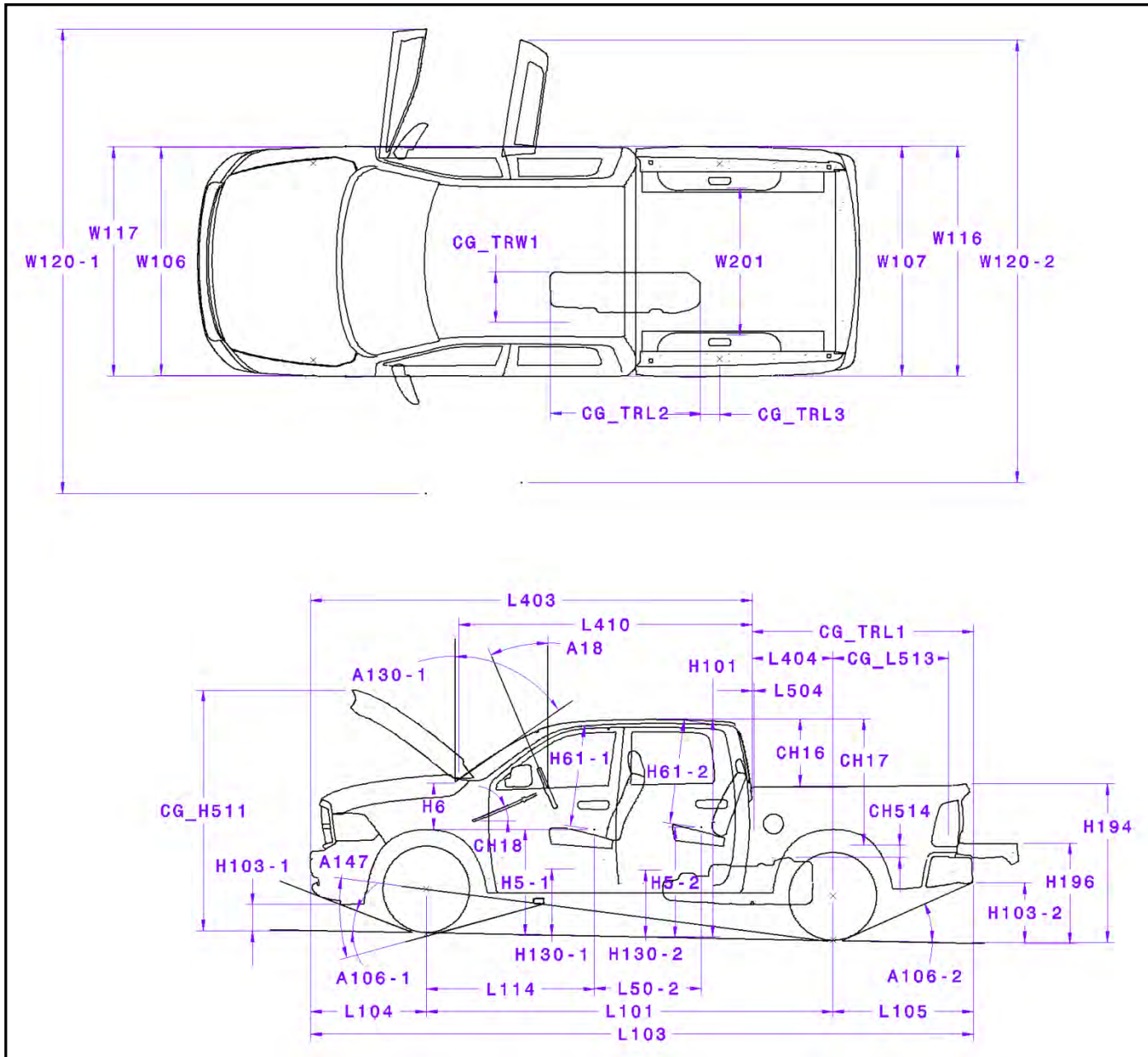

CREW CAB 2500 149.5"WB SRW 4X2 SPRING SUSPENSION

Code	Description	Metric	English
CG_TRL1	Rear Bumper to Back of Cab	2166.6 mm	85.4 in
CG_TRL2	Fuel Tank Length	1587.2 mm	62.5 in
L50-2	SgRP Couple Distance, Front to Second	939.8 mm	37.0 in
L103	Vehicle Length	6027.7 mm	237.3 in
L403	Front Bumper to Back of Cab (BBC)	3861.8 mm	152.0 in
L410	Cab Length	2574.3 mm	101.4 in
L504	Cab to Pickup Body	21.0 mm	0.8 in

Code	Description	Metric	English
A18	Steering Wheel Angle	22.9 deg	22.9 deg
A130-1	Glazing Angle - Windscreen	56.4 deg	56.4 deg
CG_A18	Steering Column Angle	23.4 deg	23.4 deg
CG_CH16	Box Floor to Cab Roof	1107.5 mm	43.6 in
CH16	Top of Box To Cab Roof	605.2 mm	23.8 in
CH514	Box Floor to Top of Fuel Tank	93.8 mm	3.7 in
H6	SgRP - Front to Windshield Lower DLO	458.2 mm	18.0 in
H61-1	Effective Head Room - Front	1041.4 mm	41.0 in
H61-2	Effective Head Room - Second	1013.5 mm	39.9 in

Code	Description	Metric	English
CG_TRW1	Outside Rail to Fuel Tank(inside)	434.2 mm	17.1 in
W144	Vehicle Width-Mirrors Included (Std)	2464.4 mm	97.0 in
W144B	Vehicle Width-Mirrors Included (Trailer)	2776.1 mm	109.3 in
W106	Fender Width - Front	2003.6 mm	78.9 in
W107	Fender Width - Rear	2015.6 mm	79.4 in
W116	Body Width-maximum	2017.4 mm	79.4 in
W117	Body Width At SgRP - Front	2008.7 mm	79.1 in
W120-1	Vehicle Width, Doors Open - Front	4076.6 mm	160.5 in
W120-2	Vehicle Width, Doors Open - Rear Row	3883.7 mm	152.9 in
W201	Cargo Width-Wheelhouse	1295.4 mm	51.1 in

CREW CAB 2500 149.5"WB SRW 4x2 SPRING SUSPENSION

Code	Description	245/70R17		275/70R18		285/60R20	
		Metric	English	Metric	English	Metric	English
A106-1	Angle of Approach	18.8 deg	18.8 deg	20.9 deg	20.9 deg	21.3 deg	21.3 deg
A106-2	Angle of Departure	22.3 deg	22.3 deg	23.9 deg	23.9 deg	24.0 deg	24.0 deg
A147	Ramp Breakover Angle	18.3 deg	18.3 deg	20.3 deg	20.3 deg	20.6 deg	20.6 deg
CG_H511	Bottom of Open Hood to Ground	2159.8 mm	85.0 in	2186.3 mm	86.1 in	2191.3 mm	86.3 in
CG_L513	Rear Axle to Inside Box at Rear	1014.3 mm	39.9 in	1014.3 mm	39.9 in	1014.3 mm	39.9 in
CG_TRL3	Rear Wheel Center line to Fuel Tank	171.4 mm	6.7 in	171.4 mm	6.7 in	171.4 mm	6.7 in
CG_TT18	Turn Circle Diameter (feet/meters)*	14.5 m	47.7 ft	14.5 m	47.7 ft	14.5 m	47.7 ft
H5-1	SgRP to Ground - Front	973.8 mm	38.3 in	1002.2 mm	39.5 in	1006.6 mm	39.6 in
H5-2	SgRP to Ground - Second	1009.4 mm	39.7 in	1038.6 mm	40.9 in	1042.7 mm	41.1 in
H101	Vehicle Height(curbLoad)	1952.5 mm	76.9 in	1981.3 mm	78.0 in	1985.5 mm	78.2 in
H103-1	Fascia(Bumper) to Ground - Front	248.3 mm	9.8 in	274.8 mm	10.8 in	279.8 mm	11.0 in
H103-2	Fascia(Bumper) to Ground - Rear	469.5 mm	18.5 in	500.8 mm	19.7 in	504.3 mm	19.9 in
H108-1	Static Load Radius - Front Tire *	368.2 mm	14.5 in	395.3 mm	15.6 in	400.1 mm	15.8 in
H108-2	Static Load Radius - Rear Tire *	376.4 mm	14.8 in	406.7 mm	16.0 in	410.5 mm	16.2 in
H130-1	Step Height - Front	619.7 mm	24.4 in	647.1 mm	25.5 in	651.6 mm	25.7 in
H130-2	Step Height - Second	629.6 mm	24.8 in	658.5 mm	25.9 in	662.7 mm	26.1 in
H148-1	Suspension or Axel to Ground - Front	155.4 mm	6.1 in	182.6 mm	7.2 in	187.4 mm	7.4 in
H148-2	Suspension or Axel to Ground - Rear	187.1 mm	7.4 in	217.5 mm	8.6 in	221.3 mm	8.7 in
H194	Closed Endgate Height	1437.5 mm	56.6 in	1468.8 mm	57.8 in	1472.3 mm	58.0 in
H196	Lift In Height	925.3 mm	36.4 in	957.0 mm	37.7 in	960.4 mm	37.8 in
L101	Wheelbase	3786.4 mm	149.1 in	3786.4 mm	149.1 in	3786.4 mm	149.1 in
L104	Overhang - Front	1010.7 mm	39.8 in	1010.7 mm	39.8 in	1010.7 mm	39.8 in
L105	Overhang - Rear	1230.5 mm	48.4 in	1230.5 mm	48.4 in	1230.5 mm	48.4 in
L114	Front Wheel Centerline toSgRP - Front	1466.2 mm	57.7 in	1466.2 mm	57.7 in	1466.2 mm	57.7 in
L404	Cab to Rear Axle (CA)	936.0 mm	36.9 in	936.0 mm	36.9 in	936.0 mm	36.9 in
W101-1	Tread Width - Front Tires	1744.6 mm	68.7 in	1719.0 mm	67.7 in	1724.0 mm	67.9 in
W101-2	Tread Width - Rear Tires	1729.0 mm	68.1 in	1703.6 mm	67.1 in	1708.6 mm	67.3 in