

CALL TODAY FOR PRICING

610 - 277 - 2101

34 / 35 / 36 SI Pad Mount

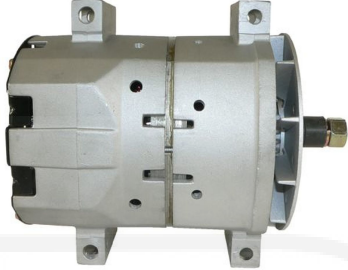

Horton Fan Clutch



9 Spring Spicer



41 MT Starter



* ALL LIGHT TO HEAVY
DUTY TRUCK CALIPERS

EATON 10 SPEEDS

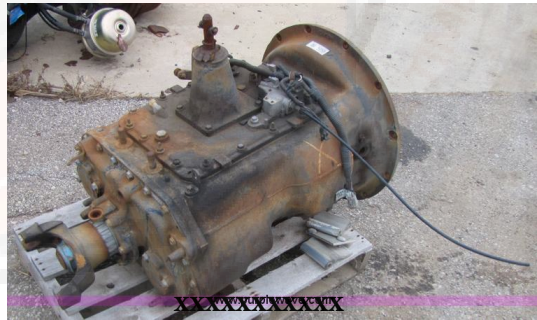

MACK & PETERBUILT AXELS



BENDIX AIR DRYERS



FUEL TANK FILL NECKS



\$ PLUS Must be Peterbuilt or

Kenworth brand

Prices subject to change without notice.

STEERING GEAR BOX

Steering Gear Needs
Sheppard

SHEPPARD STEERING GEARS: CORE IDENTIFICATION

Specific numbers	
Model & Stamp	Model & Stamp
M80 SAM	M100 PRC
M80 SAW	M100 PSA
M90 SAC	M100 PQY
M90 SAD	M100 PRZ
HD94 PN3	M100 PRH
HD94 PP3	
HD94 SC	M110 PBQ
M100 PMK	M110 PHE
M100 PET	M110 PHJ
M100 PEN	M110 PJZ
M100 PJM	M110 PQS
M100 PMK	
M100 PNJ	SD110 PAK
M100 PQF	SD110 PD3
M100 PQG	
M100 PQR	XD120 SK
M100 PQC	XD120 SC

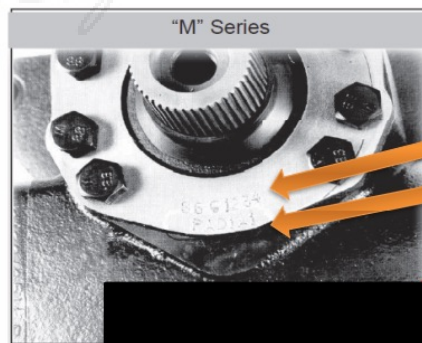
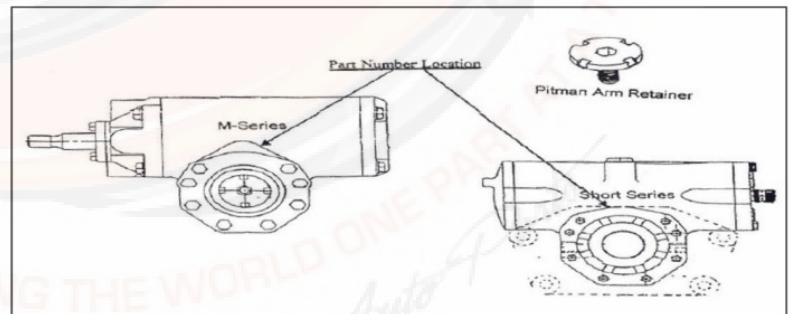

Identifying M Series Stamp Number (eg. PTD)
Model / Casting # (eg. M100)

Criteria
NO Torch Cuts
NO Broken Shafts
Must Turn

\$50 USD PLUS

Prices subject to change without notice.

SAM CHASSIS and SAM CABIN Controllers \$35



Prices subject to change without notice.

BENDIX ABS CONTROL UNITS



Bendix ABS
Control Units **\$20**

Prices subject to change
without notice.

VCU AND CPC PART



Common Powertrain Controller
(CPC) **\$30**

Prices subject to change without notice.

DIFFERENTIALS



DS344,DS404,DS404P,DS405,DSH40,DSH40P,DH44D
SH44P,
DSP40,DSP41,DSP40P,DSP41P,DST40,DST41P
\$200 PLUS Prices subject to change without notice.

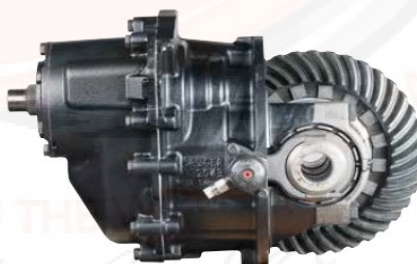

DD404,DD404P,DDH40,DDH40P, DDP40,DDP40P
\$200 PLUS Prices subject to change without notice.



19060S,19060S BC,19060S NS,19060S PB,19060S PB BC,
21060S,21060S BC,21060S
PB,P20060R,P22060S,RS405,RSH40,RSH44,RSH44
NS,RSP40,RSP41
\$85 PLUS Prices subject to change without notice.

DIFFERENTIALS



- 19060D,19060D PB,21060D,21060D
PB,P20060DR,RD404,RDH40,RDH44,RDP40,RDP41 **\$175 USD**

Prices subject to change without notice.



- D155,D155P,D156,D156P **\$250**

Prices subject to change without notice.



- D170,D170P,S170E **\$350** Prices subject to change without notice.



- D1700,D170DP,S170DE
\$350 Prices subject to change without notice.

DIFFERENTIALS



S170,S170BC,S170NS,S170R,R170.

\$300 Prices subject to change without notice.

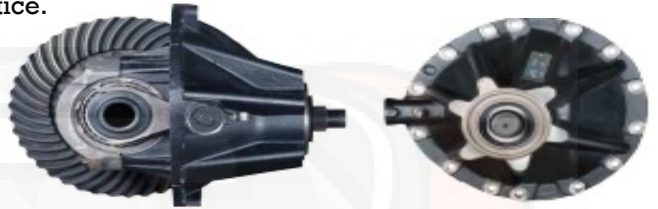

S170D,S170DBC,S170DR,R170D

\$350 Prices subject to change without notice.



D190,D190D,D590,D590D,S190DE,S190E,S590,S590D

\$375 Prices subject to change without notice.



S190,S190D,S190DR,S190NS,S190R,R190,R190D,

\$350 Prices subject to change without notice.

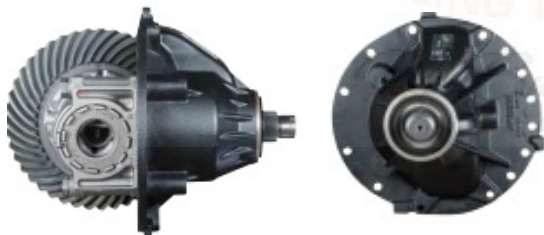

R155,R156,R155/156 **\$100**

Prices subject to change without notice.



Prices subject to change without notice.

R155D,R156D,R155/156D **\$100 USD**