

Augmentation of Safety Measures in Wi-max 802.16 using OFDM

B. Prabhakar

Associate Professor, Department of ECE,
JNTUH College of Engineering Jagtial, Telangana, India
Email Id: bprabhakar2008@gmail.com

ABSTRACT - In this paper, physical layer characterized by OFDM (Orthogonal frequency-division multiplexing) is proposed. The WiMAX 802.16 physical (PHY) layer can be characterized by various systems such as CDMA (Code Division Multiple Access), TDM (Time Division Multiplexing), FDM (Frequency Division Multiplexing) and QAM (Quadrature Amplitude Modulation). It is because, in contrast to CDMA, OFDM receiver collects signal energy in frequency domain, thus it is able to protect energy loss at frequency domain and is more resistant to frequency selective fading than single carrier systems. The OFDM is accompanied by 64-bit QAM, to achieve the maximum PSNR (Peak signal-to-noise ratio) and to remove the AWGN (Additive White Gaussian Noise) associated with the channel. The simulations are performed using MATLAB tool and better results are achieved when compared to previous models of physical layer in WiMAX. All the simulations are performed using MATLAB tool.

Keywords: WiMAX, CDMA, TDM, FDM, QAM, OFDM, PSNR and AWGN.

I. INTRODUCTION

The IEEE 802.16 standard belongs to the IEEE 802 family i.e., Ethernet. WiMAX is a form of wireless Ethernet and therefore the whole standard is based on the Open Systems Interconnections (OSI) reference model. With respect to OSI model, the lowest layer is the physical layer. It specifies the frequency band, the modulation scheme, error-correction techniques, synchronization between transmitter and receiver, data rate and the multiplexing techniques. To ensure the most efficient delivery in terms of bandwidth and available frequency spectrum, the IEEE 802.16 physical layer uses a number of legacy technologies. These technologies include Orthogonal Frequency Division Multiplexing (OFDM), Time Division Duplexing (TDD) [1], Frequency Division Duplexing (FDD), Quadrature Amplitude Modulation (QAM), and Adaptive Antenna System (AAS). The WiMAX physical layer is based on OFDM [1] [7] [8]. OFDM is the transmission scheme of choice to enable high speed data, video, and multimedia communications and presently, besides WiMAX, it is used by a variety of commercial broadband systems, including DSL, Wi-Fi, Digital Video Broadcast-Handheld (DVB-H).

II. IEEE 802.16 PHYSICAL LAYER

The IEEE 802.16 standard supports multiple physical specifications due to its modular nature. The first version of the standard only supported single carrier modulation. Since that time, OFDM and scalable OFDMA have been included to operate in NLOS (Non-Line of Sight) environment and to provide mobility. The standard has also been extended for use in below 11 GHz frequency bands along with initially supported 1066 GHz bands.

III. IEEE 802.16 PHY INTERFACE VARIANTS

The standard has assigned a unique name to each physical interface.

A. *WirelessMAN-SC*TM

This is the only PHY specification defined to operate in 1066 GHz frequency band. It employs single carrier modulation with adaptive burst profiling, in which transmission parameters, including the modulation and coding schemes, may be tuned individually to each subscriber station (SS) on a frame-by-frame basis. The standard both supports Frequency Division Duplexing (FDD) and Time division Duplexing (TDD) to separate 16 uplink and downlink. The standard also supports half duplex FDD SS, which may be less expensive as they do not transmit and receive simultaneously [1]. This duplexing technique is common to all the PHY specifications. Access in uplink direction is done by combination of time division multiple access (TDMA) and Demand Assignment Multiple Access (DAMA), exactly the uplink channel is divided into several time slots. Communication on the downlink in PTM Architecture is employed using Time Division Multiplexing (TDM). It also specifies the randomization, forward error correction (FEC), modulation and coding schemes.

B. *WirelessMAN-SCa*TM

This is also based on single carrier modulation targeted for 211 GHz frequency range. Access is done by TDMA technique both in uplink and downlink, additionally TDM also supported in downlink.

C. *WirelessMAN-OFDM*TM

This is based on orthogonal frequency division multiplexing (OFDM) with a 256 point transform to support multiple SS in 211 GHz frequency band. Access is done by TDMA. The

WiMAX forum has adopted this PHY specification for BWA. Because of employing OFDM and other features like multiple forward error correction method, this is the most suitable candidate to provide fixed support in NLOS environment. We have chosen this PHY specification for our simulation model. From next sections our discussion will be on this PHY layer.

D. WirelessMANOFDMA™

This PHY specification uses OFDM access (OFDMA) with at least a single support of specified multipoint transform (2048, 1024, 512 or 128) to provide combined fixed and Mobile BWA. Operation is limited to below 11 GHz licensed band [2]. In this specification multiple access is provided by addressing a subset of the multiple carriers to individual receivers [3].

E. WirelessHUMAN™

This specification is targeted for license exempt band below 11 GHz. Any of the air interfaces specified for 211 GHz can be used for this. This supports only TDD for duplexing [4].

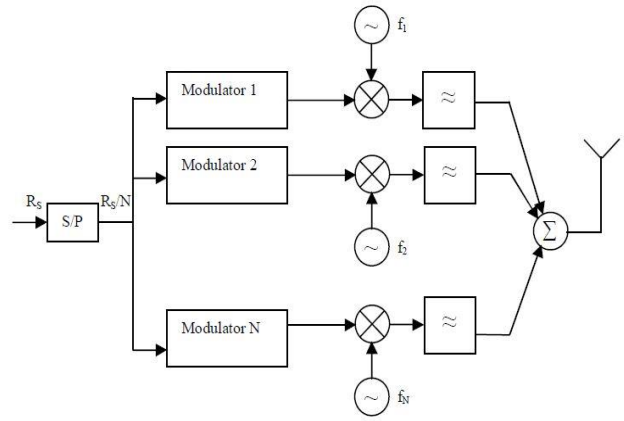

Fig.1. Block diagram of a generic MCM transmitter.

V. OFDM SYSTEM DESIGN CONSIDERATIONS

OFDM system design issues aim to decrease the data rate at the subcarriers, hence, the symbol duration increases and as a result, the multipath effects are reduced effectively. The insertion of higher valued CP will bring good results against combating multipath effects but at the same time it will increase loss of energy. Thus, a tradeoff between these two parameters must be done to obtain a reasonable system design. OFDM system depends on the following four requirements: [6]

- A. *Available bandwidth:* The bandwidth limit will play a significant role in the selection of number of subcarriers. Large amount of bandwidth will allow obtaining a large number of subcarriers with reasonable CP length.
- B. *Required bit rate:* The system should be able to provide the data rate required for the specific purpose.
- C. *Tolerable delay spread:* A user environment specific maximum tolerable delay spread should be known beforehand in determining the CP length.
- D. *Doppler values:* The effect of Doppler shift due to user movement should be taken into account.

VI. ANALYSIS AND RESULTS

The curves show the BER as a function of the bit energy to noise rate (E_b/N_0), which is a measure of the energy efficiency of a modulation scheme. If a higher E_b/N_0 is needed to transfer data for a given modulation scheme, it means that more energy is required for each bit transfer. Low spectral efficiency modulation schemes, such as BPSK and 4-QAM, require a lower E_b/N_0 , and hence, are more energy efficient and less vulnerable to bit errors. Furthermore, the BER versus the SNR can be calculated from E_b/N_0 . The SNR for each modulation takes into account the number of bits per symbol, and so, the signal power corresponds to the energy per bit times the number of bits per symbol. All the simulations have been performed using MATLAB tool [11]. The BER vs. SNR curves for

Designation	Band of operation	Duplexing techniques
WirelessMANSCT™	10-66 GHz	TDD, FDD
WirelessMANSCa™	2-11 GHz Licensed band	TDD, FDD
WirelessMANOFDM™	2-11 GHz Licensed band	TDD, FDD
WirelessMANOFDMA™	2-11 GHz Licensed band	TDD, FDD
WirelessHUMAN™	2-11 GHz Licensed Exempt Band	TDD

IV. OFDM

The idea of OFDM comes from Multicarrier Modulation (MCM) transmission technique. The principle of MCM describes the division of input bit stream into several parallel bit streams and then they are used to modulate several sub carriers as shown in Figure. Because of the combination of multiple low data rate subcarriers, OFDM provides a composite high data rate with long symbol duration. Depending on the channel coherence time, this reduces or completely eliminates the risk of InterSymbol Interference (ISI), which is a common phenomenon in multipath channel environment with short symbol duration. The use of Cyclic Prefix (CP) in OFDM symbol can reduce the effect of ISI even more [5], but it also introduces a loss in SNR and data rate.

various modulation schemes are obtained as follows. While performing simulations of various modulation schemes, the following are taken as the default values for uniformity in outputs.

Value of G (Cyclic Prefix) = 1/32

Number of OFDM symbol = 100

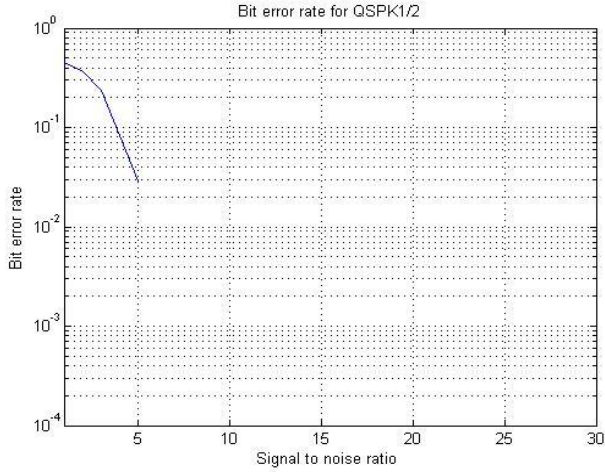

Fig.2. BER vs. SNR for QPSK 1/2



Fig.3. BER vs. SNR for QPSK 3/4

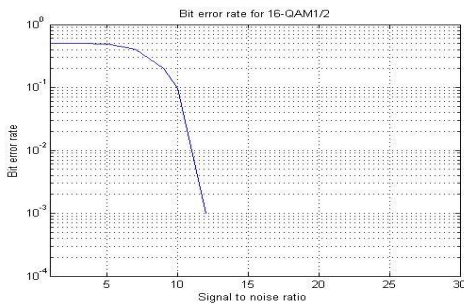

Fig.4. BER vs. SNR for 16-QAM 1/2

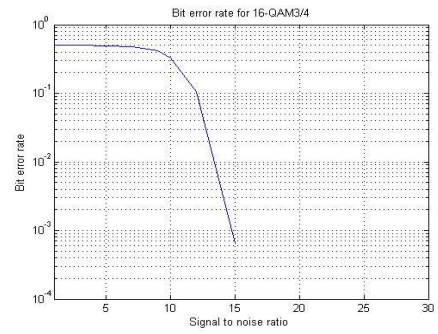

Fig.5. BER vs. SNR for 16-QAM

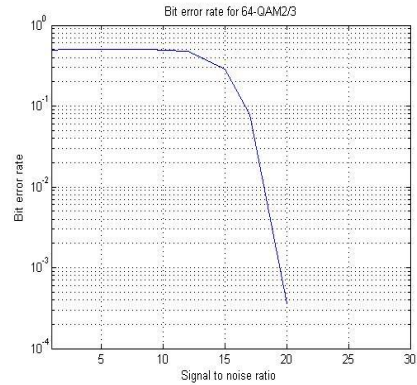

Fig.6. BER vs. SNR for 64-QAM 2/3

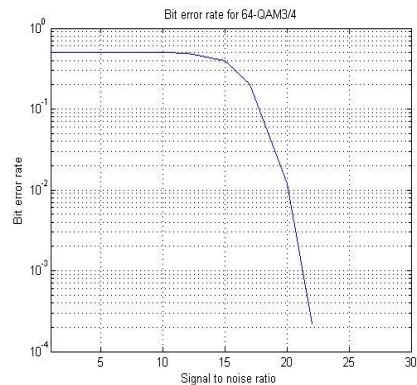

Fig.7. BER vs. SNR for 64-QAM 3/4

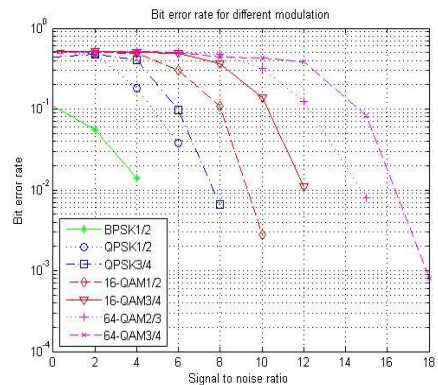

Fig.8. Combined plot of BER vs. SNR for various modulation scheme

VII. CONCLUSIONS

In the present scenario where the wireless industry requires high amount of security and also due to increased demands for various applications like voice and data, WiMAX seems to be the best possible solution to fulfill the requirements such as voice, data, and multimedia, providing vehicular mobility and high service areas and data rates. Defined to provide broadband wireless access, it is increasingly gaining interest as an alternative last mile technology to DSL lines and cable modems, and a complementary technology where wireless networks are not sufficiently developed.

Simulations are performed on WiMAX Physical layer using various modulation schemes and different rate ID's. The OFDM based WiMAX proved to be the most efficient one with respect to security and throughput. The BER vs. SNR curves also illustrate the same pattern regarding the modulation scheme employed for the WiMAX.

VIII. REFERENCES

- [1] C. Eklund, "IEEE Standard 802.16: A Technical Overview of the WirelessMAN™ Air Interface for Broadband Wireless Access," IEEE Commun. Mag., pp. 98107, June 2002
- [2] IEEE Std 802.16e2005 and IEEE Std 802.162004/ Cor 12005 (Amendment and Corrigendum to IEEE Std 802.162004)," IEEE Standard for Local and metropolitan area networks Part 16: Air Interface for Fixed and Mobile Broadband Wireless Access Systems Amendment 2: Physical and Medium Access Control Layers for Combined Fixed and Mobile Operation in Licensed Bands and Corrigendum 1", February 2006
- [3] "IEEE Standard 802.16 for Global Broadband Wireless Access," http://ieee802.org/16/docs/03/C8021603_4.pdf last accessed 15.01.14
- [4] IEEE 802.162004," IEEE Standard for Local and Metropolitan Area Networks Part 16: Air Interface for Fixed Broadband Wireless Access Systems", 1 October, 2004
- [5] R.V. Nee & R. Prasad, *OFDM for Wireless Multimedia Communications*. Artech House Publishers, 2000.
- [6] M. Rahman , S. Das , F. Fitzek, "OFDM based WLAN systems", Technical Report, Aalborg University, Denmark, February 2005
- [7] Ghosh, A.; Wolter, D.R.; Andrews, J.G.; Chen, R., "Broadband wireless access with WiMax/802.16: current performance benchmarks and future potential", Communications Magazine, IEEE, Vol.43, Iss.2, Feb. 2005, Pages: 129-136
- [8] Koffman, I.; Roman, V.,"Broadband wireless access solutions based on OFDM access in IEEE 802.16" Communications Magazine, IEEE, Vol.40, Iss.4, April 2002,Pages:96-103
- [9] IEEE Std 802.162001," IEEE Std. 802.162001 IEEE Standard for Local and Metropolitan area networks Part 16: Air Interface for Fixed Broadband Wireless Access Systems", December 2001
- [10] Wu, Zhongshan, "MIMO-OFDM Communication Systems: Channel Estimation and Wireless Location", Ph.D Thesis, Dept. of Electrical & Computer Engineering, Louisiana State University, USA, May 2006
- [11]"The Matlab help: Communications Blockset," <http://www.mathworks.com>
- [12] A. van Zelst, R. van Nee, and G. A. Awater: "Space division multiplexing (SDM) for OFDM systems," IEEE 51st Vehicular Technology Conference (VTC) Proceedings, vol. 2, pp. 1070-1074, Tokyo, Spring 2000.
- [13] M. Engels:"Wireless OFDM systems. How to make them work?" Kluwer Academic, 2002.
- [14] R. S. Bahai, and B. R .Saltzberg:"Multi-carrier digital communications: theory and applications of OFDM," New York Springer, 2004.
- [15] L. W. Couch:"Digital and Analog Communication Systems," 6th edition, Prentice Hall, 2001.
- [16] M. Barbeau, 2005, "WiMAX/802.16 Threat Analysis" School of Computer Science Carleton University, 1125 Colonel by Drive. Ottawa, Ontario, Canada
- [17] David Johnston, Jesse Walker, 2004 "Overview of IEEE 802.16 Security, IEEE Security & Privacy".
- [18] Jamshed Hasan, "Security Issues of IEEE 802.16 (WiMAX)", 2006.
- [19] Barbeau, M 2005, "WiMAX/802.16 Threat Analysis", retrieved on 15th January, 2014 from <http://www.scs.carleton.ca/~barbeau/publications/2005/iq2-barbeau.pdf>
- [20] Liu, F 2004, "IEEE 802.16 WiMAX", retrieved on 15th January, 2014 from <http://www.seas.gwu.edu/~cheng/388/LecNotes2006/80216 WiMAXSecurity.ppt>
- [21] Aikaterini, A.V, 2006, "Security of IEEE 802.16", retrieved on 15th January, 2014 from URL:<http://www.dsv.su.se/research/seclab/pages/pdf-files/2006-x-332.pdf>
- [22] WiMAX Forum:"Mobile WiMAX. Part I: A Technical Overview and Performance Evaluation," August 2006. <http://www.intel.com/netcomms/technologies/wimax>