

# BZ Products Inc. U.S.A.

## Model MPPT 100/25 Installation Instructions

Thank you for choosing BZ Products MPPT 100/25. Made entirely in the USA, operation of this unit is fully automatic, and works in conjunction with all battery other charging sources.

**Read all instructions before installing and using the MPPT 100/25**



**MPPT 100/25**

BZ Products Inc.  
8801 Gravois Road  
St. Louis, Missouri 63123 USA  
314-644-2490  
bzp@bz-products.net

## Model MPPT 100/25 Installation Instructions

Refer to Illustration 1.

Securely install the MPPT 100/25 control in a dry, protected location. Do not install in direct sunlight or near heat sources. Provide a minimum of 6" clearance on all sides of the control. Install the MPPT 100/25 as close to the battery as possible.

Modifying the MPPT 100/25 in any manner will void the warranty.

- 1 Remove 4 cover screws.  
Maintain 6" clearance.  
Secure the control using  
the 4 mounting holes provided.

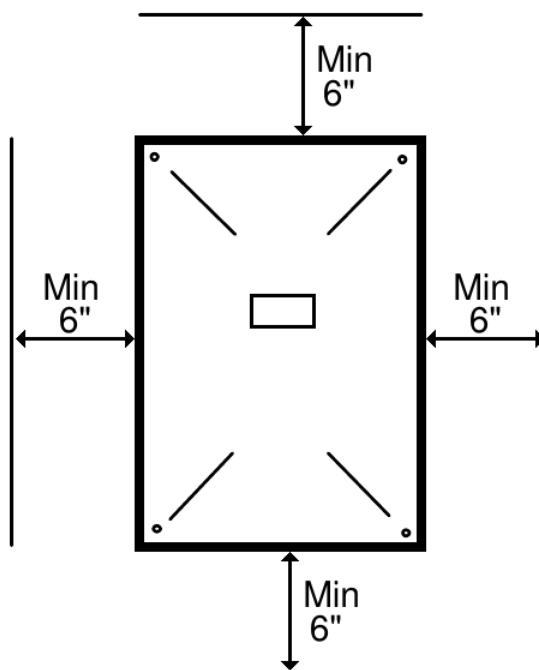

**Illustration 1**

Refer to Illustrations 2 and 3 (this page).

Locate and identify Switch "SW1".

Select the battery voltage and battery type. The MPPT 100/25 control is shipped set up for 12 volt VRLA (Valve Regulated Lead Acid) battery systems. Refer to SW 1 settings diagram Illustration 3 to determine the setup of the MPPT 100/25 control.

No battery equalization is applied in the VRLA battery charge profile. To manually equalize, move flooded battery position 5 of SW 1 to the right for a two hour equalization cycle. The MPPT 100/25 will then revert to float mode. SW 1 positions 7 and 8 are for future use.

Switch SW1

PV

Battery



Illustration 2

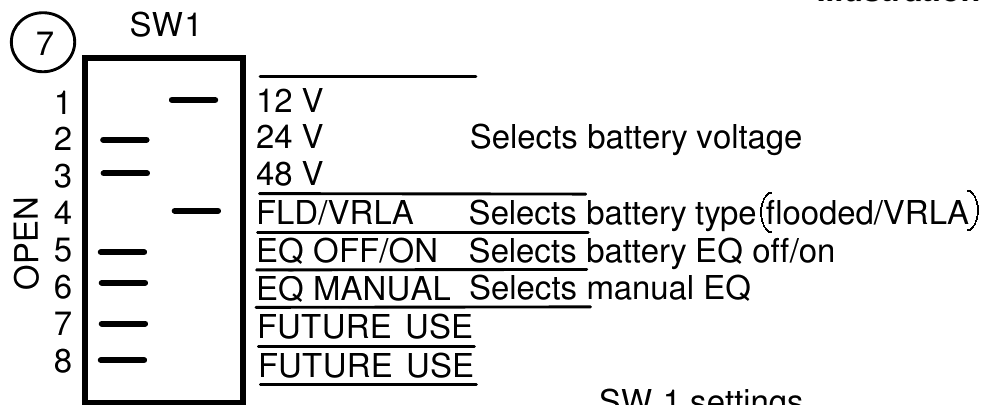

Illustration 3

SW 1 settings  
 12 volt battery selected  
 VRLA selected set as shipped

Refer to Illustrations 2 and 3 (above).

Install the battery wiring and battery fuse. NOTE POLARITY! Use stranded copper wire only. Locate the battery fuse within 10" of the battery. Minimum recommended battery circuit wire size is #6 AWG copper. Route the battery circuit wiring as directly as possible to the battery. Use fuses and fuse holders rated for DC applications. Do not use automotive style fuses. The battery fuse should be rated for 30 amps at a minimum of 100 Vdc.

NOTE! Wiring the MPPT 100/25 control reverse-polarity to the battery may damage the control, and is not covered by warranty.

Attach the battery temperature sensor to the case of the battery. For the most accurate operation, the battery temperature sensor should be located in the center of one side of the battery. Illustration 6.

Secure all wiring.

Refer to Illustrations 4 and 5 (below).

Install the solar panel wiring. Use stranded wire only. Minimum recommended solar circuit wire size is #10 AWG copper. Route the wire as directly to the MPPT 100/25 control as possible. Use fuses and fuse holders rated for solar use. Do not use automotive style fuses. Solar circuit fuse should be rated for 15 amps at >100 Vdc. Locate the solar circuit fuse near the MPPT 100/25 control.

Secure all wiring.

Install the earth ground using the ground lug located on base of the MPPT 100/25 control. Use # 10 AWG or larger stranded copper wire. Illustration 7.

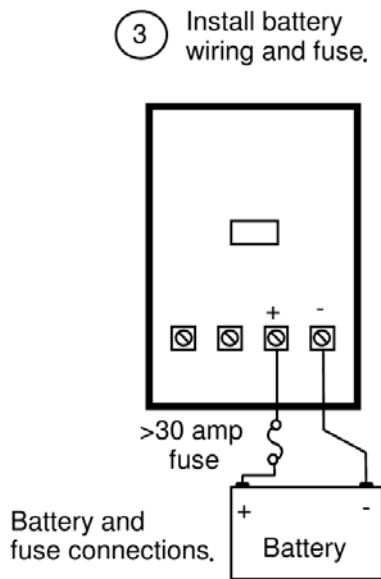

**Illustration 4**

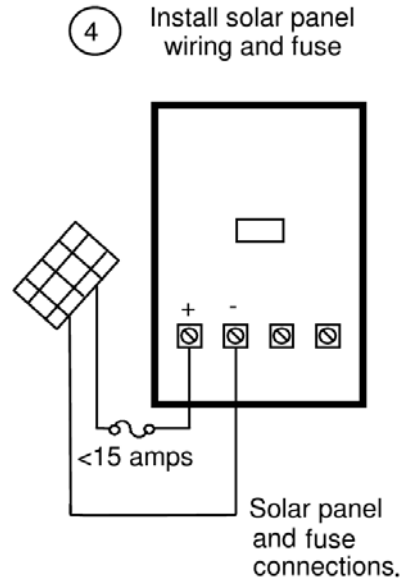

**Illustration 5**

5 Attach the battery temp sensor to the battery.

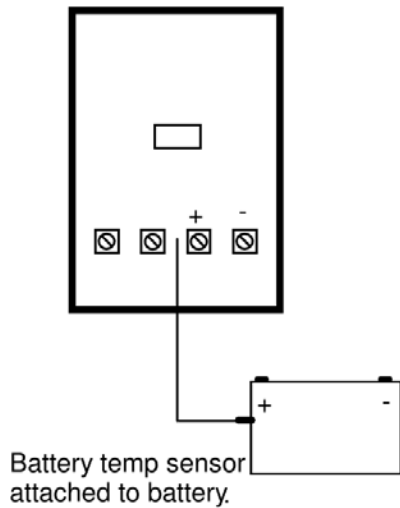

Illustration 6

6 Install chassis earth ground.

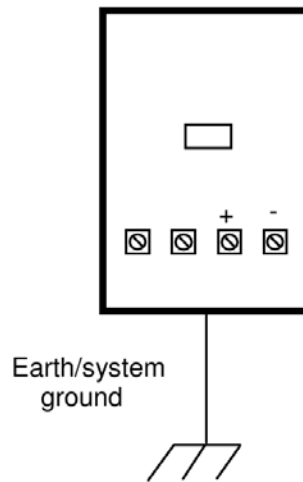

Illustration 7

Refer to Illustrations Table 1 and Table 2 (below).

Locate and identify the LED indicators.

**Indicators:** Battery charging status is determined by the two LEDs located on the face plate. A blinking yellow LED indicates the control in in bulk charge mode. A solid yellow LED indicates the control is in the two hour acceptance mode. A blinking red LED indicated the control in in float mode. And a solid red LED indicated the control is in the two hour equalization mode. If solar power to the MPPT 100/25 is lost (cloud cover or shadows) the control restarts in the bulk charge mode. The digital volt meter displays battery voltage and battery charge current.

Table 1 - LED

Battery Status LED	Charge Mode
Blinking Yellow Led	Bulk
Solid Yellow Led	Acceptance
Blinking Red Led	Float
Solid Red Led	Equalization

Table 2 - LED Modes

Yellow LED blinking --- BULK Charge

Yellow LED on --- ABSORB Charge

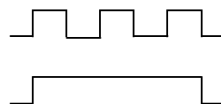

BULK  
ABSORB



Red LED blinking --- FLOAT Charge

Red LED on --- EQUALIZE CHARGE

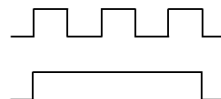

FLOAT  
EQUALIZE



## **Installation Suggestions and Troubleshooting for the MPPT 100/25 control**

Warning! Batteries produce explosive gases. Refer installation to a qualified solar installer.

Do not exceed the PV maximum input voltage or solar panel power ratings.

For best operation, the solar panel voltage must be greater the minimum specified. Do not exceed the maximum PV input voltage of 100 Vdc.

Plan the installation to maximize the power produced by the solar panel(s), including panel location and mounting angle. Minimize the solar panel wire distance. Use larger wire size to reduce losses. Use a high quality DC-rated fuse or circuit breaker.

Install batteries in a well ventilated area. Protect the batteries from damage. Maintain the batteries as recommended by the manufacture. Use larger size wire up to #2 maximum. Keep the batteries fully charged. Do not charge a frozen battery. Place the battery temperature sensor on the battery as instructed. Ensure there are no loose wire strands inside the MPPT 100/25.

Do not install the MPPT 100/25 in small confined spaces. Keep out of direct sunlight and away from other heat sources.

Do not mix solar panel types, voltages or power ratings.

Do not connect the MPPT 100/25 to generators or alternators.

Do not alter the MPPT 100/25 in any manner. Modifying the MPPT 100/25 will void the warranty, and may lead to damage and/or destruction to other system equipment.

### **Troubleshooting the MPPT 100/25**

Make certain the battery and solar panel are connected to the MPPT 100/25 controller. Make sure all connections are clean and free from oxidation and corrosion.

Check the battery fuse and solar panel fuse with a meter. Replace bad fuses. If the meter display of the MPPT 100/25 is blank no power is applied to the control.

If the battery voltage displayed on the MPPT100/25 digital meter is reading erratically, the battery fuse may be open. Replace the bad fuse and check the associated wiring and connections.

When both the yellow LED and red LED are off, the control is the “hunting” mode, and no charge current is applied to the battery.

For additional technical help, call BZ Products Inc. 314-644-2490 Monday-Friday, between 9:00 am and 5:00 pm Central Time.

## Warranty

Model MPPT 100/25 is warranted to be free of defects in material and workmanship for five years from the date of purchase. Failure to provide proper installation and operation in accordance with the instruction manual will void the warranty. Product liability shall be limited to repair or replacement, at the discretion of the manufacturer. The manufacturer is not responsible for the labor or other charges necessitated by the removal, transportation, or reinstallation of any defective product. Warranty does not cover damage due to mishandling, abusive conditions, lightning, or exposure to weather. No specific claim of merchantability shall be assumed or implied beyond what is printed in this manual. No liability shall exist from circumstances arising from the inability to use this product or its inappropriateness for any specific purpose. In all cases, it shall be the responsibility of the customer to insure a safe installation in compliance with local, state and national electrical codes. Modifying the MPPT 100/25 in any way will void the warranty.

**RETURN PROCEDURE:** For warranty service of the MPPT 100/25, provide the following information:

Your name, return address, phone number, e-mail, a brief description of the failure, and a copy of the sales receipt. Include \$14.00 for return shipping and insurance.

Return to BZ Products Inc.

BZ Products, Inc.  
8801 Gravois Road  
St. Louis, Missouri 63123 USA  
314-644-2490  
[www.bz-products.net](http://www.bz-products.net)  
[bzp@bz-products.net](mailto:bzp@bz-products.net)

## Unit Specifications

Battery Voltage (Nominal)	<b>12 Vdc</b>	<b>24 Vdc</b>	<b>48 Vdc</b>
PV Input Power Maximum	375 Watts	750 Watts	1500 Watts
PV Input Voltage Minimum / Maximum	30 Vdc / 100 Vdc	60 Vdc / 100 Vdc	80 Vdc / 100 Vdc
Bulk Voltage Flooded	14.4 Vdc	28.8 Vdc	57.6 Vdc
Absorption Voltage Flooded 2 Hours	14.4 Vdc	28.8Vdc	57.6 Vdc
Float Voltage Flooded	13.7 Vdc	27.4 Vdc	54.8 Vdc
Equalization Voltage @ 29 Days 2 Hours	14.9 Vdc	29.8 Vdc	59.6 Vdc
Bulk Voltage - VRLA 2 Hours	14.0 Vdc	28.0 Vdc	56.0 Vdc
Absorption Voltage - VRLA	14.0 Vdc	28.0 Vdc	56.0 Vdc
Float Voltage - VRLA	13.7 Vdc	27.4 Vdc	54.8 Vdc
Battery Temperature Compensation	-5mV Per °C Per Cell		
Minimum Battery Voltage	0.0 Volts		
Charge Current Derating	25 Amps Continuous, Current Limited, No Derating		
Metering, LEDs	Digital Battery Volt / Charge Amp Meter. Two Charge Status LEDs.		
Temperature Range	-30° C to + 60° C Non-Condensing		
Cabling / Grounding	#10 to #2 AWG Copper Wire, Two 3/4" Wire Conduits, #6 Ground Lug		
Battery Bank	Minimum 100 A-H 12V, 24V, and 48 Vdc (Selectable)		
Dimensions-Mounting	6.5" x 8.5" x 2.25", 4 Ea #6 Screw		
Weight	2 Pounds (0.91 kG)		
Setup	DIP Switch Selects Battery Voltage, Battery Type, Auto / Manual EQ		
Construction	0.06" Aluminum, Spot Welded, Black Powder-Coat Finish		
Warranty	Five Years from Date of Purchase		



# MPPT 100/25 Installation Instructions

- 1 Remove 4 cover screws  
Maintain 6" clearance  
Secure the control using the 4 mounting holes provided

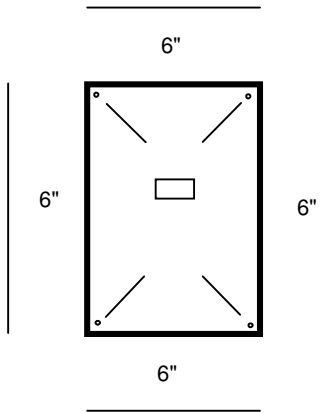

- 2 Select battery voltage and battery type

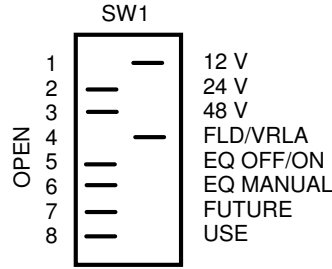

12 volt battery selected  
VRLA selected set as shipped

- 3 Install battery wiring and fuse

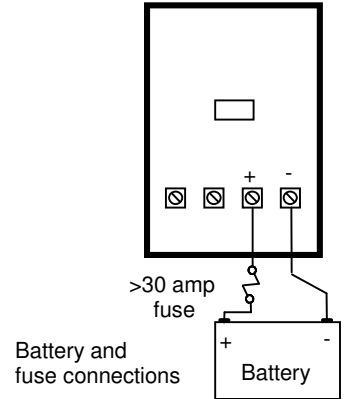

- 4 Install solar panel wiring and fuse

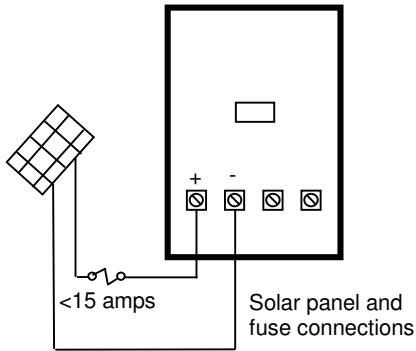

- 5 Attach the battery temp. sensor to the battery

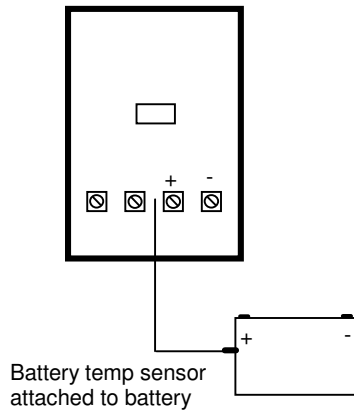

- 6 Install chassis earth ground

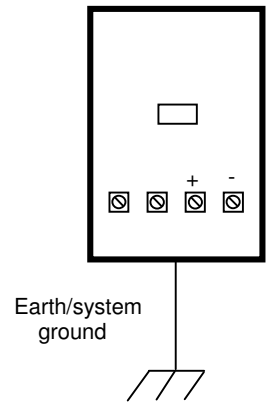

- \* Follow instructions in order  
Do not drop  
Do not get wet  
Do not disturb any internal components  
Install in accordance with local codes  
Install suitably rated fuses and wire  
Provide grounding to the system

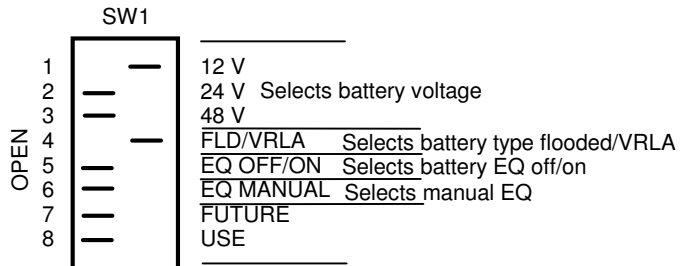

SW 1 settings  
12 volt battery selected  
VRLA selected set as shipped