

The prevailing water of Noah's flood

(a chronology of the flood)

Yves Peloquin

Montreal, Oct 6, 2011

Revised Sept 27, 2021

<http://ezekielmasterkey.com/>

- Gen 7:11 In the six hundredth year of Noah's life, **on the seventeenth day of the second month**--on that day all the springs of the great deep burst forth, and the floodgates of the heavens were opened. NIV
- Gen 8:14-16 **By the twenty-seventh day of the second month** [*of Noah's six hundred and first year*] the earth was completely dry. Then God said to Noah, "Come out of the ark
NIV

Setting the specific chronology of the flood would seem an easy task. After all, the Bible does supply five specific markers and mentions a few periods of time for an event that lasted about a year. Apparently many have been seduced by this unchallenging undertaking and have proposed their own but nevertheless nearly identical understanding of this short period.

There is however one difficulty that everybody have solved with the same apparent lack of concern about the oddity of the explanation. In the Bible's description of the flood it is said that the water prevailed for a period of 150 days and there is a mention of a five-month stretch. In each timeline that I have seen, the author systematically proposed that the two periods overlap therefore, at the time of the flood, every month were exactly 30 days in length ($5 * 30 = 150$). This extraordinary conclusion would mean that the orbit of the moon around the earth was slightly different at the time of Noah than it is nowadays. I don't buy that. Let us keep in mind that the flood was God's method of destroying a corrupt world. There was no need to alter the motion of the moon along the way.

- Gen 6:13 "I am going to put an end to all people, for the earth is filled with violence because of them. I am surely going to destroy both them and the earth. NIV

If you are familiar with my other works you already know that I firmly believe God left a signature in the Bible's chronology, it can be seen in the form of patterns, symmetry, and beauty. As for me, I will always interpret the absence of these three elements from any Bible's proposed timeline as a sign of inaccuracy and a clue that there are some elements that have not been properly understood. God's chronology cannot lead to a bleak design.

The timeline proposed in this article will show that it is possible to harmonize all the chronological information found in Gen 7 & 8 and obtain a logical picture of what really occurred while Noah was in the Ark.

In the following three pages we are going to build a basic (and somewhat uncontroversial) timeline of the flood. Later we will see how it is possible to elaborate this basic timeline to expose patterns never seen until now.

We start with the following

5 **B**ible **D**ates. (Let's call these dates **BD1 ... BD5**)

Note: these are the only specific dates, relating to Noah's flood, that are supplied in the Bible. We will use them to create an elaborate flood timeline.

Ark is closed Rain started M2 D17 Y600	←..... BD1	Gen 7:11 In the six hundredth year of Noah's life, in the second month, the seventeenth day of the month, on that day all the fountains of the great deep were broken up, and the windows of heaven were opened. NKJV
Ark rests M7 D17 Y600	←..... BD2	Gen 8:4 Then the ark rested in the seventh month, the seventeenth day of the month, on the mountains of Ararat. NKJV
Top of mountain is visible again M10 D1 Y600	←..... BD3	Gen 8:5 In the tenth month, on the first day of the month, the tops of the mountains were seen. NKJV
Water gone M1 D1 Y601	←..... BD4	Gen 8:13 and it came to pass in the six hundred and first year, in the first month, the first day of the month, that the waters were dried up from the earth; NKJV
Ark open M2 D27 Y601	←..... BD5	Gen 8:14-16 And in the second month, on the twenty-seventh day of the month, the earth was dried. Then God spoke to Noah, saying, "Go out of the ark, NKJV

Others dates will be obtained indirectly in this work and to distinguish them from the ones supplied in the Bible we will call them **D6, D7... etc.**

The Bible also supplies
 6 'Bible Values' (BV1 to BV6)
 associated with periods of days
 during the time of the Flood.

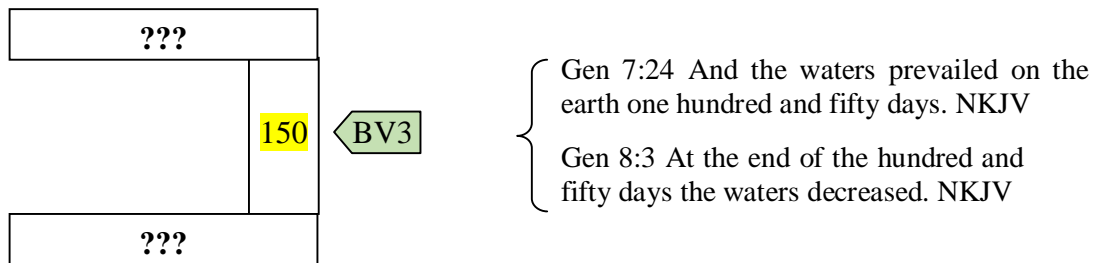
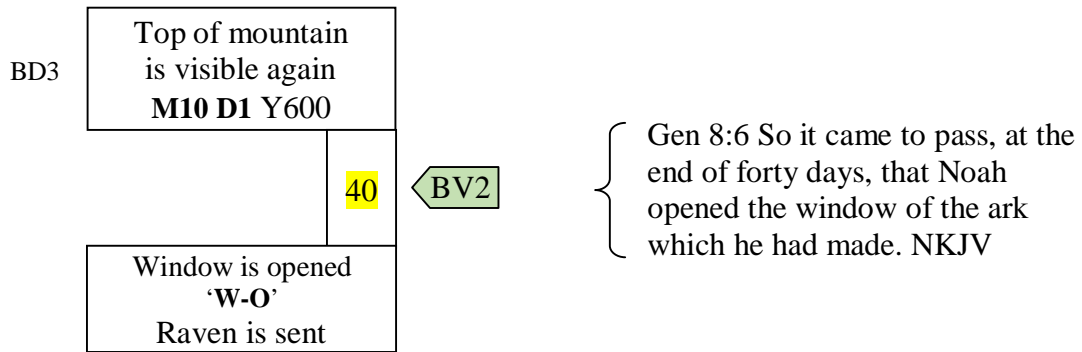
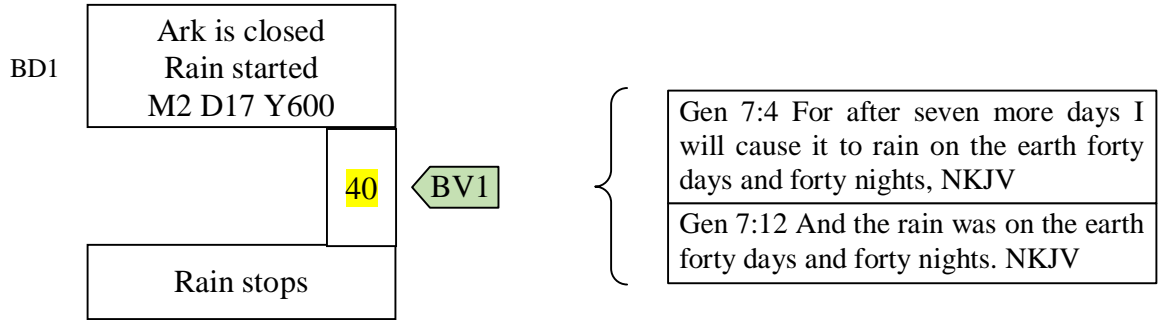

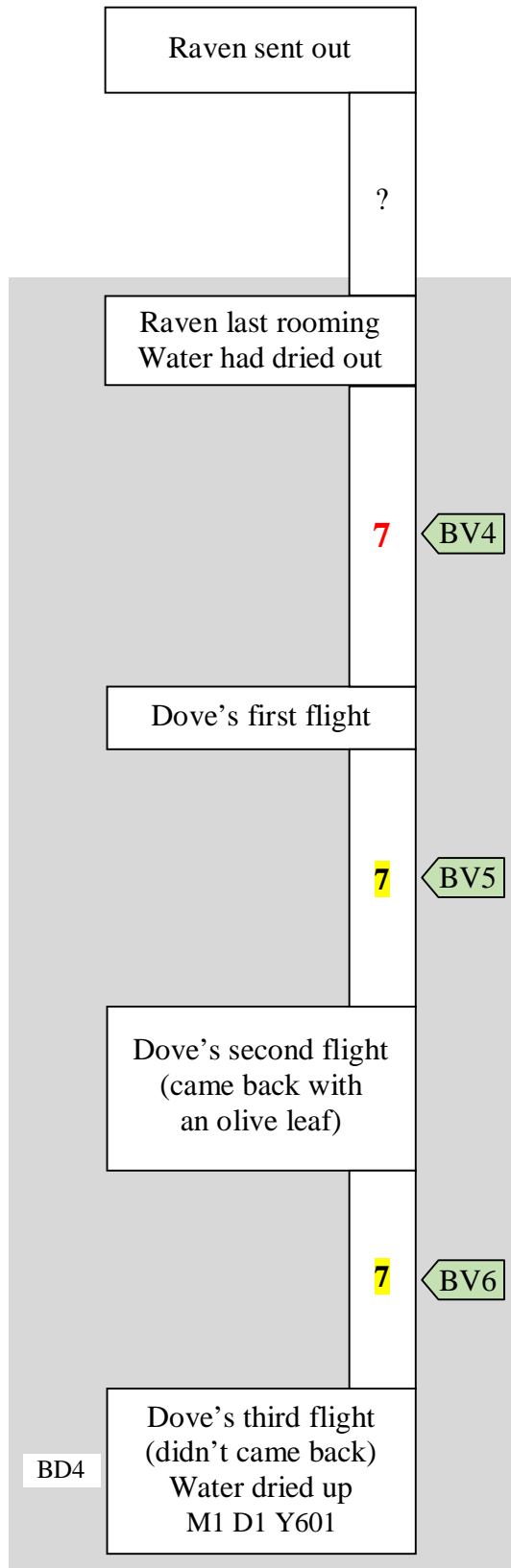

Gen 8:7 and sent out a raven, and it kept flying back and forth until the water had dried up from the earth. NIV

It is implied here that more than one day elapsed.

We will see later that it took 28 days

This seven-day period is not directly stated in the text, but can be derived from the subsequent verses.

Genesis 8:10 states that Noah waited, when the dove came back the first time, "**yet another seven days**" (P5) before sending the dove out for the second time. This implies that Noah had also waited 7 days (P4) before sending the Dove the first time.

Gen 8:10 And he waited yet another seven days, and again he sent the dove out from the ark. NKJV

Gen 8:11 When the dove returned to him in the evening, there in its beak was a freshly plucked olive leaf! Then Noah knew that the water had receded from the earth.

Gen 8:12 He waited seven more days and sent the dove out again, but this time it did not return to him. NIV

Gen 8:12 but this time it did not return to him. NIV

Gen 8:13 and it came to pass in the six hundred and first year, in the first month, the first day of the month, that the waters were dried up from the earth; NKJV

Others values will be indirectly obtained in this work and to distinguish them from the ones supplied in the Bible we will call them **V7**, **V8**, ... ect

From the
Bible's dates BDx
 and the
Bible's values BVx
 previously enumerated,
 we can build a basic
 timeline of the flood.

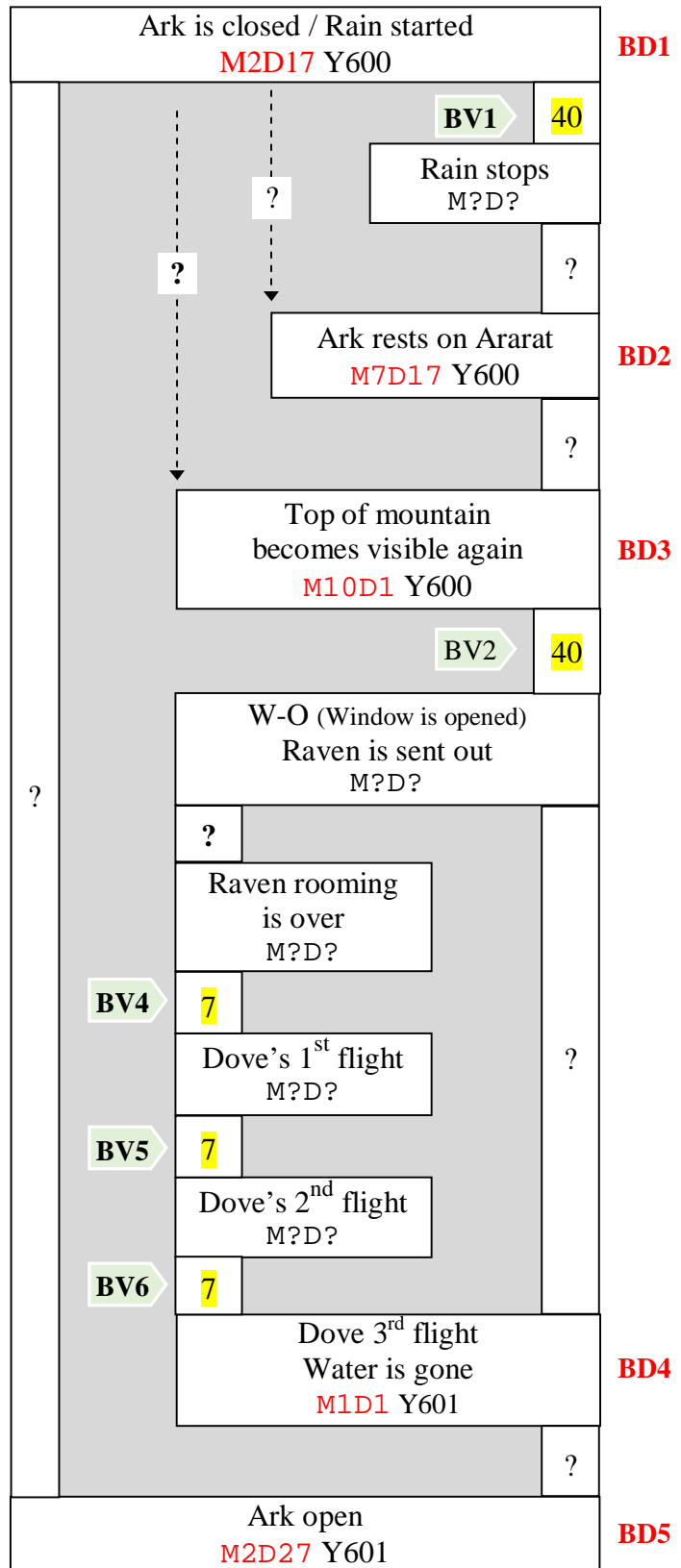
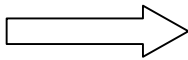

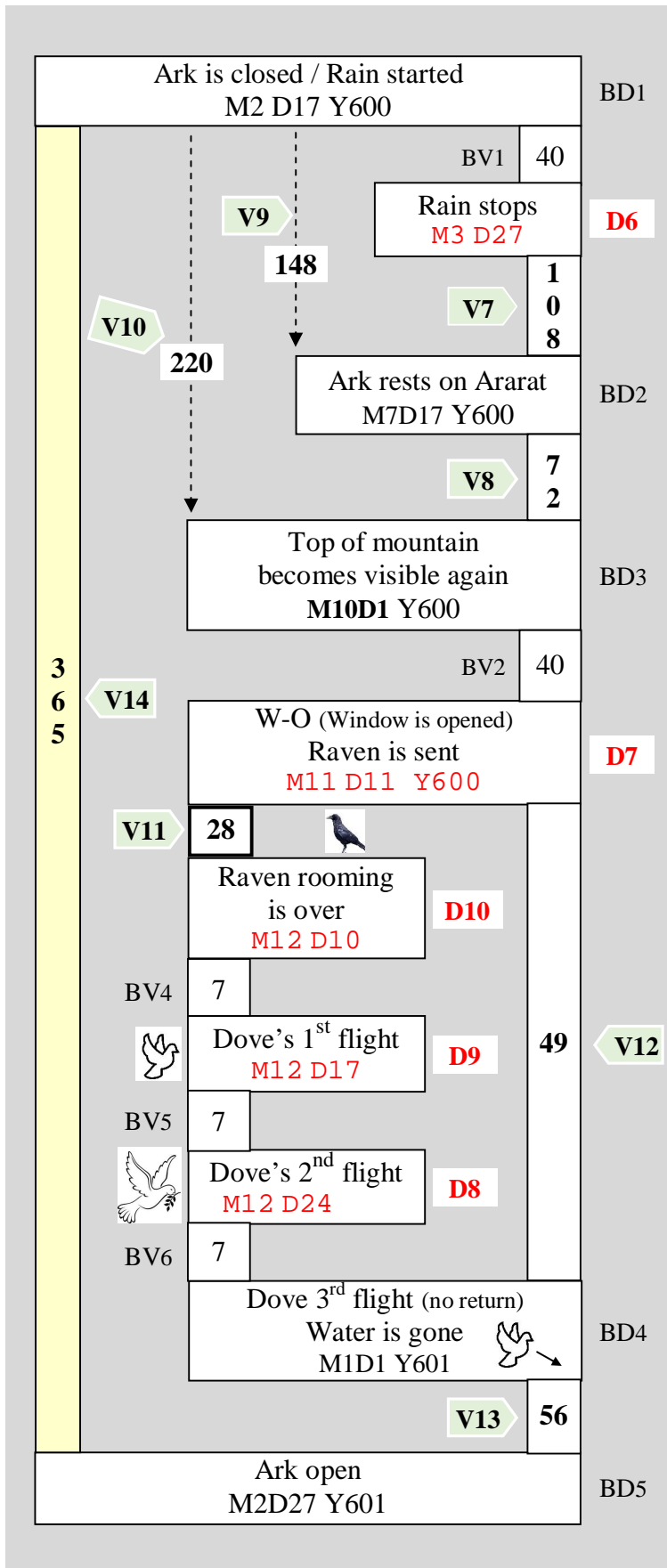

Let's date some events and find the number of days between them.

New dates (Dx) are obtained by adding (or subtracting) an already known number of days (Vx or BVx) from the previous or the next date available.

$$\begin{aligned}
 D6 &= BD1 + BV1 &= M3D27 \\
 D7 &= BD3 + BV2 &= M11D11 \\
 D8 &= BD4 - BV6 &= M12D24 \\
 D9 &= D8 - BV5 &= M12D17 \\
 D10 &= D9 - BV4 &= M12D10
 \end{aligned}$$

In a similar way, new values (Vx) are obtained by counting the number of days between two already known dates or by combining intermediary values.

$$\begin{aligned}
 V7 &= BD2 - D6 &= 108 \\
 V8 &= BD3 - BD2 &= 72 \\
 V9 &= BV1 + V7 &= 148 \\
 V10 &= BV1 + V7 + V8 &= 220 \\
 V11 &= D10 - D7 &= 28 \\
 V12 &= V11 + BV4 + BV5 + BV6 &= 49 \\
 V13 &= BD5 - BD4 &= 56 \\
 V14 &= V10 + BV2 + V12 + V13 &= 365
 \end{aligned}$$

Note: To facilitate these operations a calendar is proposed at the end of this article.

Important :

It is said here that V11 = 28 days. This is not speculative. We first found out that the raven stop rooming the earth (D10) on M12D10 by going backward from the Dove third flight (BD4), 2nd flight (D8) and 1st flight (D9). Then we found out that the date the raven was sent was M11D11 (D7) by going forward 40 days from the time the top of the mountain became visible on M10D1 (BD3).

Using the proposed calendar at the end of this paper it was easy to count 28 days from D7 (M11D11) to D10 (M12D10).

The chronology of the raven

Seven days (BV4) before the first flight of the dove on M12D7 (ref D9) something happened (this is implied by Gen 8:10). We are not told directly what this event was, however we know that the raven had been sent out of the Ark prior to that and it had kept flying back and forth. Based on the fact that Noah waited yet another seven days (Gen 8:10) before sending the dove on its second expedition, we are quite justified in assuming that the raven must have stopped roaming the earth and gone back (to or in) the Ark on M12D10 (ref D10) (i.e. 7 days before the dove 1st flight).

(There is much more to say about the raven, see on my website the article under the title: [The Flight of Noah's Raven](#))

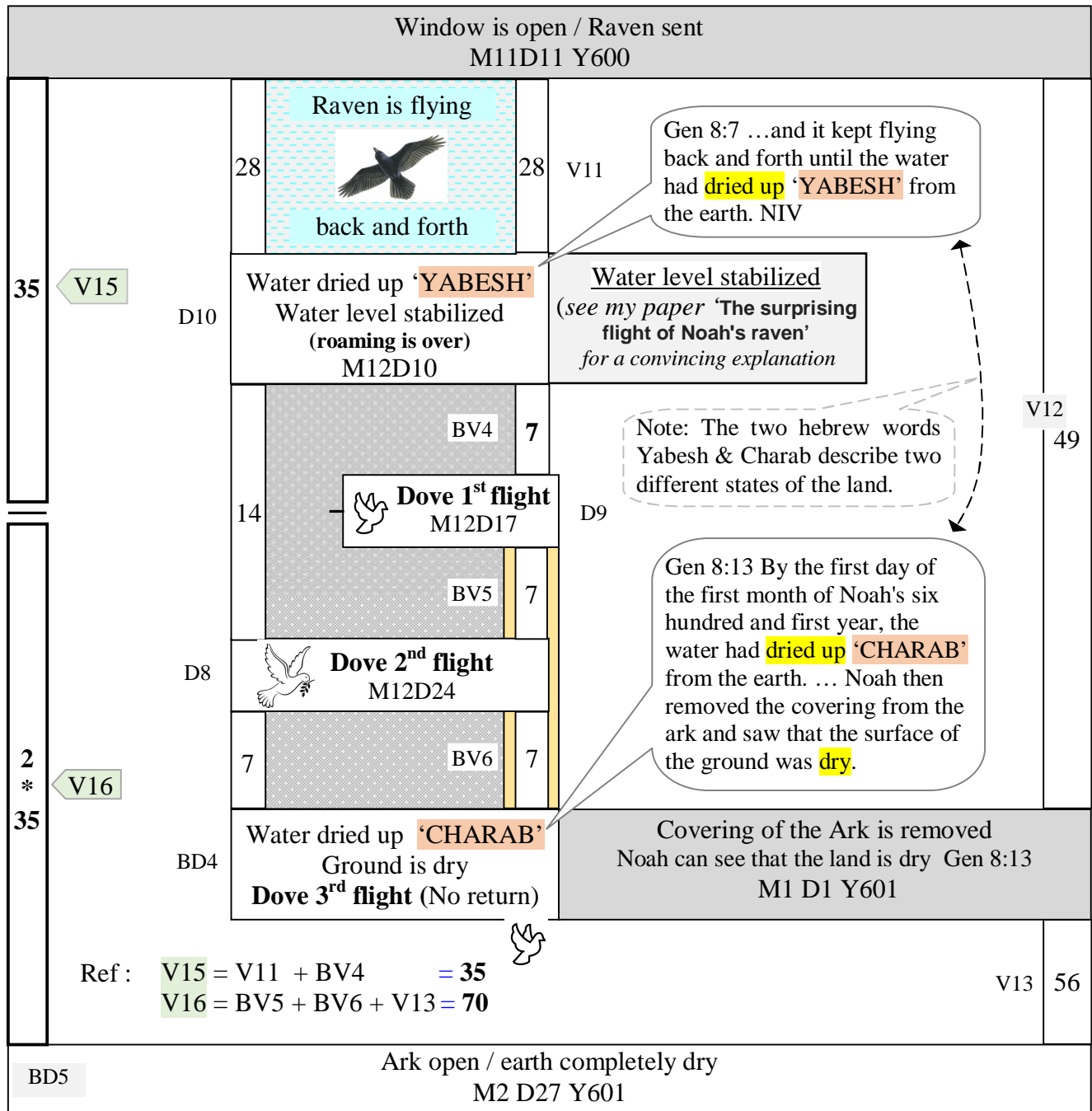

In the time frame presented on page 6, I didn't show the 150 days (periods BV3 of page 3) described in Gen 7:24 and Gen 8.3. It is traditionally accepted that these 150 days represent the exact five-month period between the start of the rain BD1 (M2D17) and the Ark touching ground on mount Ararat BD2 (M7D17). As shown in the next timeframe this is absolutely unacceptable as it would contradict what can be observed on any Hebrew calendar.

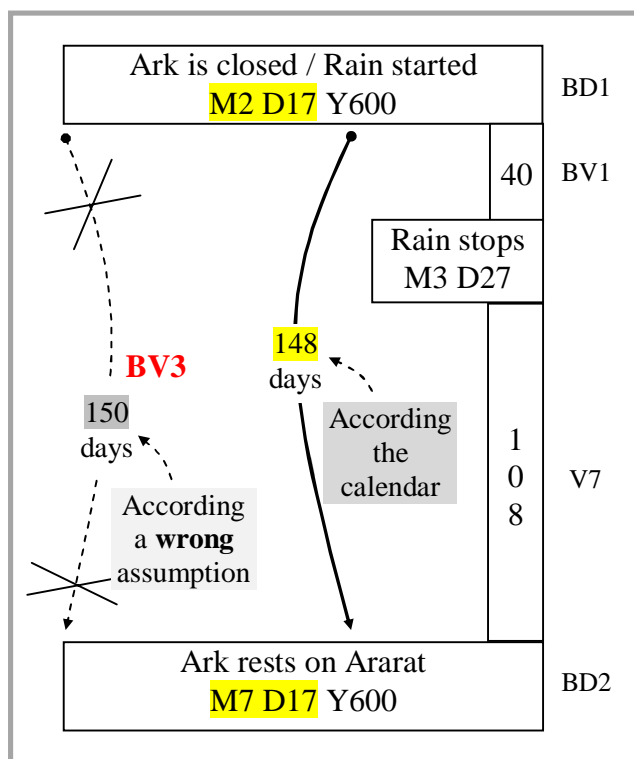

On the Hebrew calendar there could be no more than 148 days between the 17th day of the 2nd month (M2D17) and the 17th day of the 7th month (M7D17).

Here the reader has to understand that the Hebrew calendar uses lunar months which start at the time of a new moon and end at the time of next new moon. The exact astronomical length of a lunar month is 29.5305 days but in practical usage it is understood that a month has a length that alternates from 29 to 30 days. As an exception two successive months could have 30 days but it would never happen for three months in a row. Therefore, on any sequence of five Hebrew months (as is the case in the biblical period which goes from M2D17 to M7D17) there will always be at least two months with a length of 29 days. A direct outcome of this arrangement limits any period of five months to be 147 or 148 days.

Was the moon slower at the time of the flood (thus making a five-month period equal to 150 days instead of the 148 obtained when one observes the contemporary motion of the moon)? If you answer yes to this question there is no point trying to figure out any part of the Bible's chronology. How could you know what would be the right duration of any months of the past if it could not be deduced from the modern observations? However, if you answer no and you believe that the motion of the moon has always been the same either before or after the flood, then you have to accept that there is a better answer to the question: What exactly took place during the 150 days of Gen 7:24?

- Gen 7:24 And the waters prevailed on the earth one hundred and fifty days. NKJV

The biggest misunderstanding about the 150 days of 'prevailing water' has been to tag the beginning of that period with the day that the rain started falling.

- Gen 8:3-4 At the end of the hundred and fifty days the waters decreased. NKJV
- Gen 7:11 In the six hundredth year of Noah's life, on the seventeenth day of the second month--on that day all the springs of the great deep burst forth, and the floodgates of the heavens were opened. NIV

The water didn't prevail when the rain started falling.

A quick look in any dictionary will tell us that 'prevail' means 'triumph'. In the context of a global flood, during which the whole earth was going to be drowned, 'prevailing' could only mean that the water was winning over the land, the whole land. When did this happen? Answer: At the exact time **the water overflowed the highest summit**. When did the water stop prevailing? My answer: after the water had receded enough to make the highest peak visible. Gen 7:24 is telling us that for **150 days there was only water visible on the surface of the earth** – no land could be seen anywhere 'on the planet'.

NOTE: Once the top of the last mountain was hidden Noah lost all its bearings and he had no way to know if the Ark was going up or down. From Noah's point of view the water was prevailing over the earth.

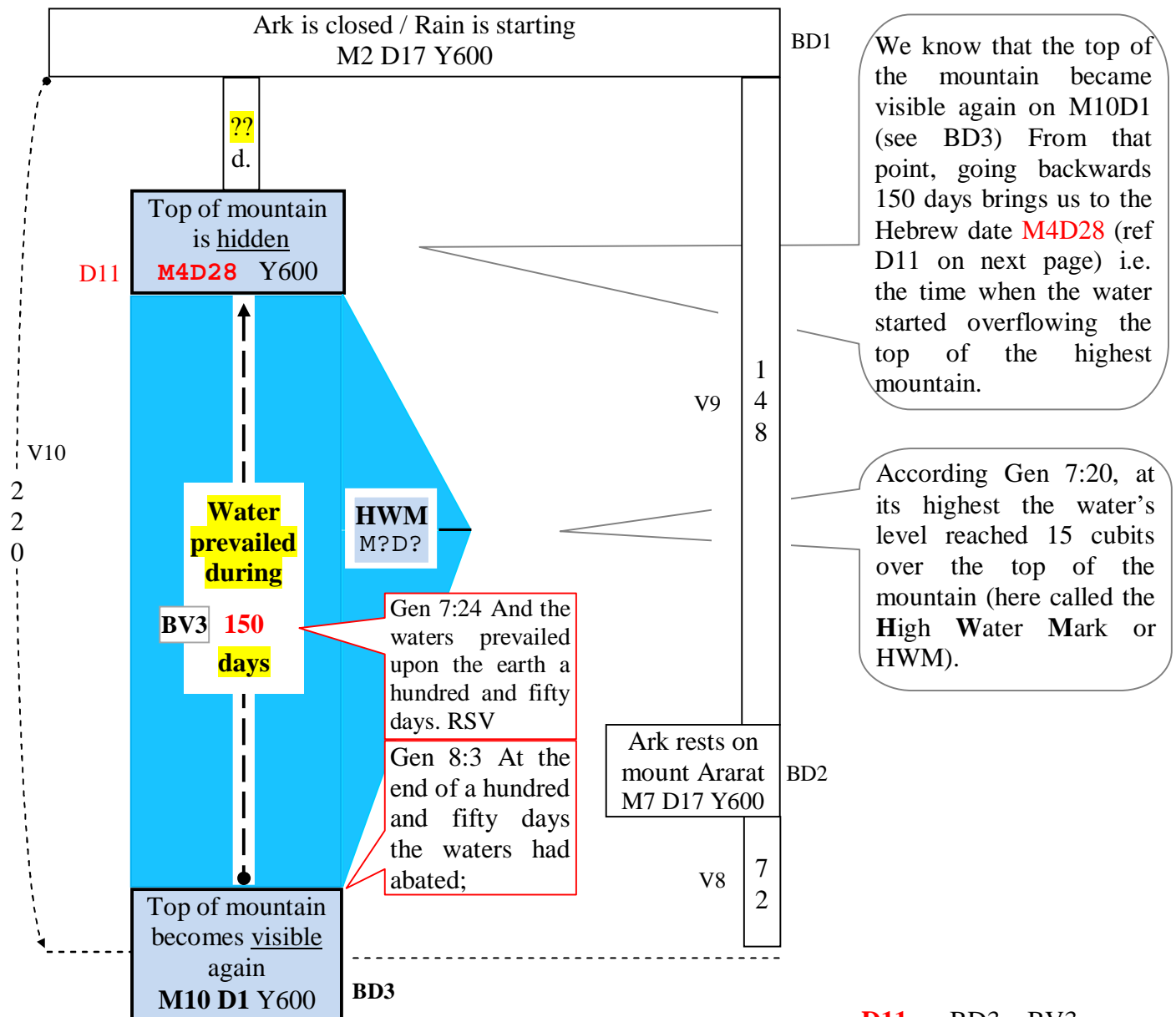

Note: My understanding about this remarkable meaning of the '150 days' came from reading the article "Noah's 365 Days in The Ark" by Henk W. Jens.

$$\begin{aligned} \text{D11} &= \text{BD3} - \text{BV3} \\ &= \text{M10D1} - 150 \text{ days} \\ &= \text{M4D28} \end{aligned}$$

The 40 rainy days versus the 150 days of prevailing water

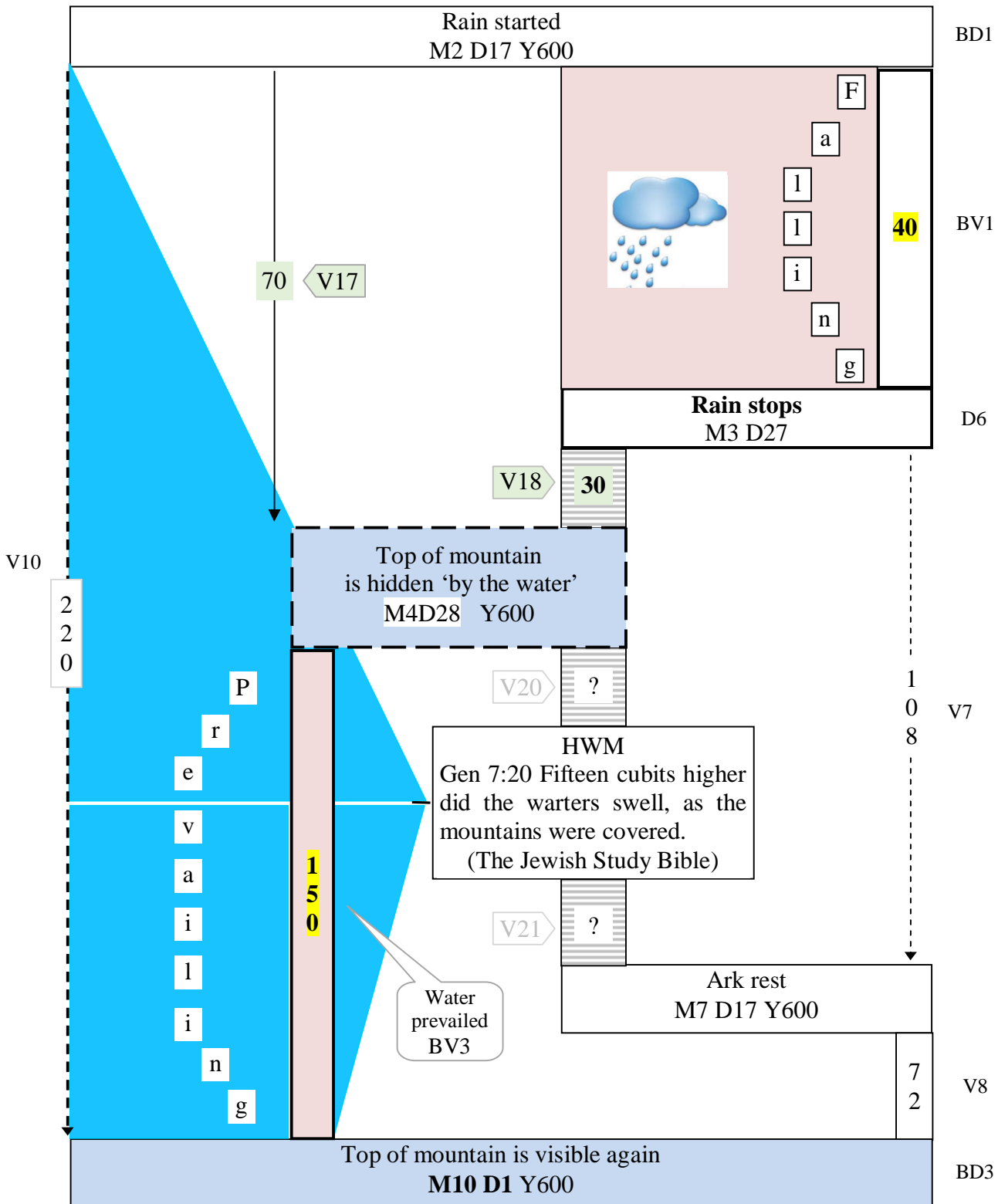

V17 = V10 - BV3 = 70

V18 = V17 - BV1 = 30

It is now obvious that a major problem has arisen with our sequence of events. How could had the water level reach the top of the mountain as late as **M4D28**

if the rain had stopped falling on **M3D27** ?
I.e. a full month before

Does the Bible contradict itself?
Of course not.

It is more likely that we have mistakenly assumed something that we should not have.

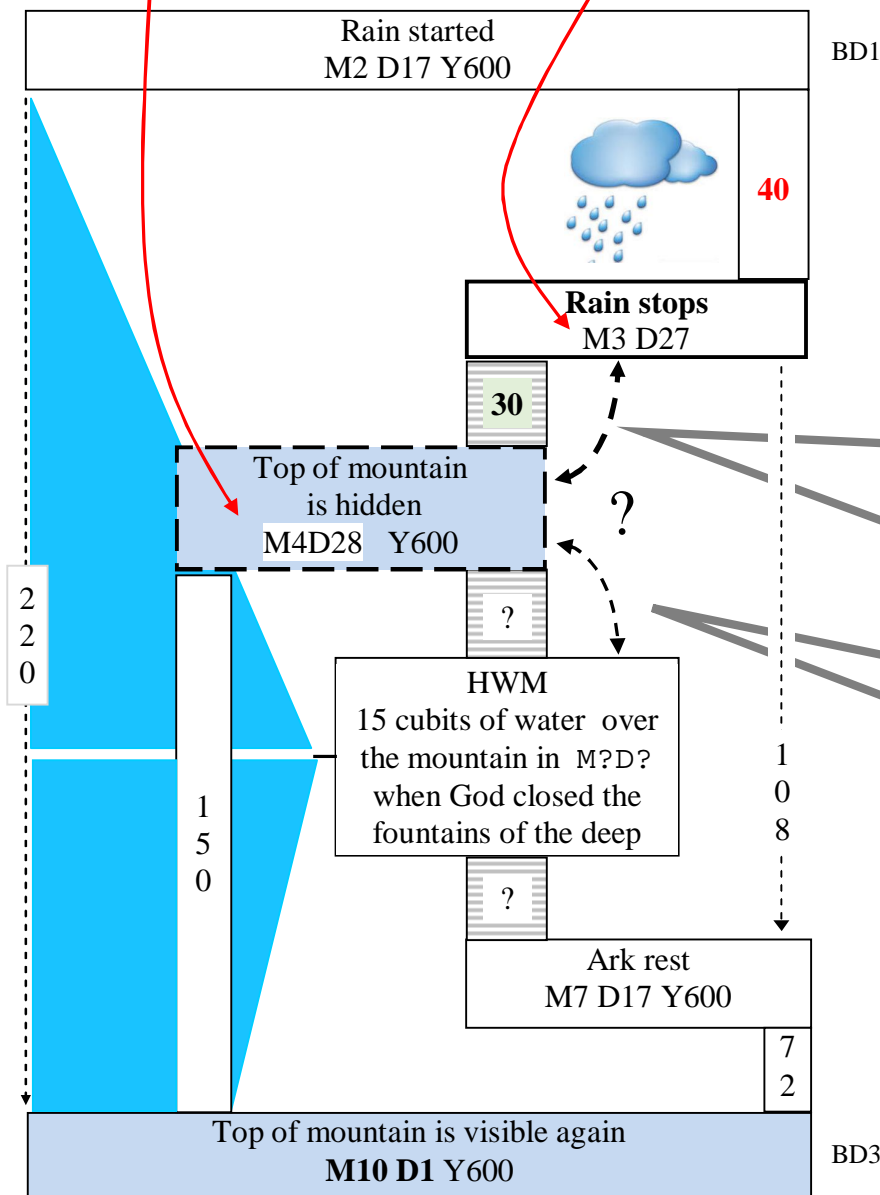

Given that the **rain** stopped after 40 days (see D6) water from another source must have keep coming otherwise the level of water wouldn't have reached the top of the mountain 30 days later.

In order to cover the mountain with an additional 15 cubits, the 'other' source of water was kept active for some time after M4D28

There were two sources of water to feed the flood. The rain and the springs of the great deep.

- Gen 7:11 on the seventeenth day of the second month--on that day all **the springs of the great deep** burst forth, and the **floodgates of the heavens** were opened. NIV

We are told twice that the rain fell for 40 days.

- Gen 7:4 I will send rain on the earth for forty days and forty nights, and I will wipe from the face of the earth every living creature I have made." NIV
- Gen 7:12 and rain fell on the earth forty days and forty nights. NIV

but we are never told how long the fountain of the great deep stayed open. It is my belief that the water of the great deep kept coming for another 40 days after the rain stopped.

- **Gen 7:17** For forty days the flood kept coming on the earth, and as the waters increased they lifted the ark high above the earth. NIV

Note : To my knowledge I am the only one who have ever suggested that the flood water increase for two successive period of 40 days. In the first period of 40 days the water came from the rain and from the fountains of the deep. In the second period of 40 days the water came only from the fountains of the deep and it is during that time that the water reached over the highest mountain.

Gen 7:20 Fifteen cubits upward did the waters prevail; and the mountains were covered. KJV

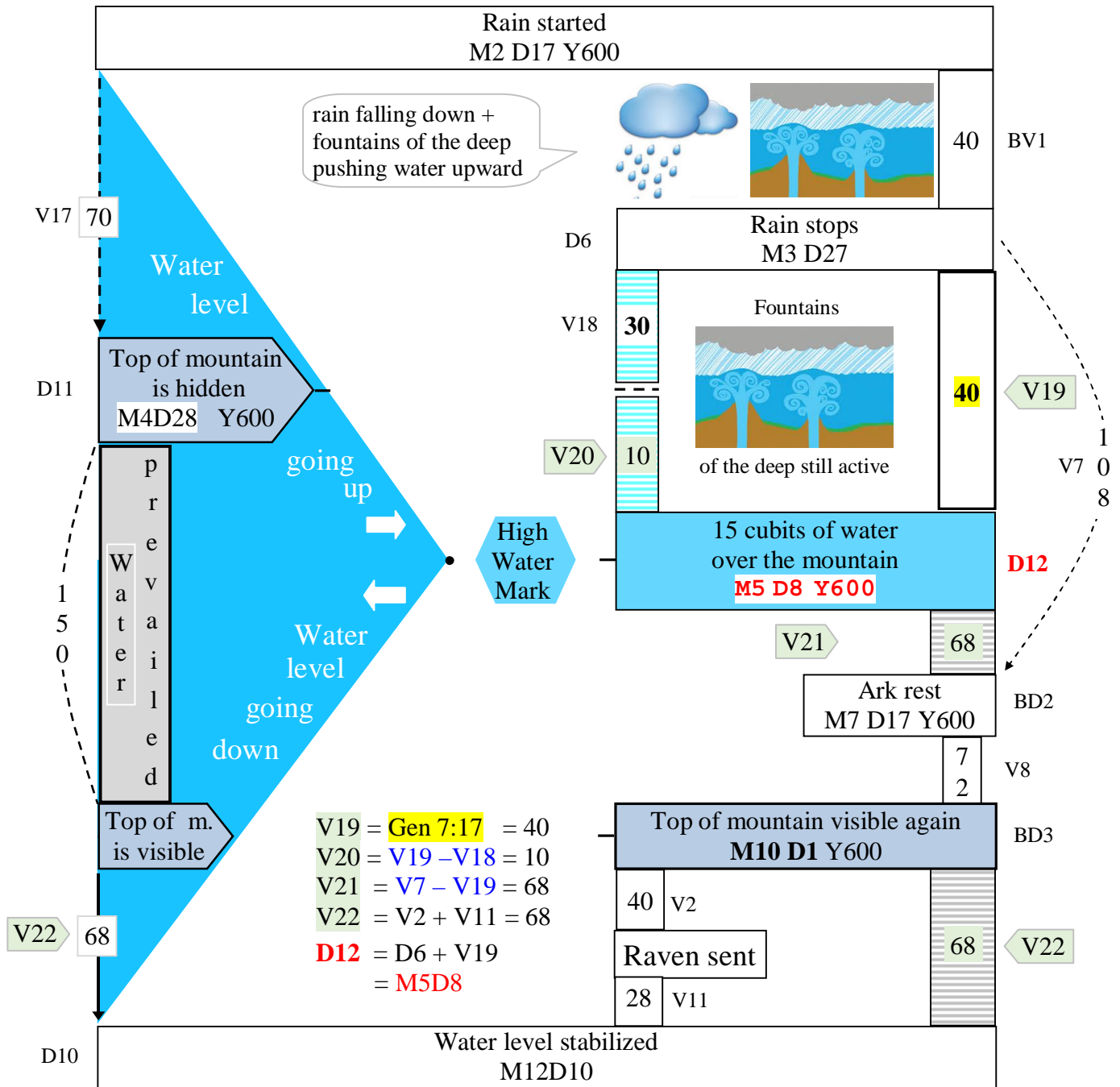

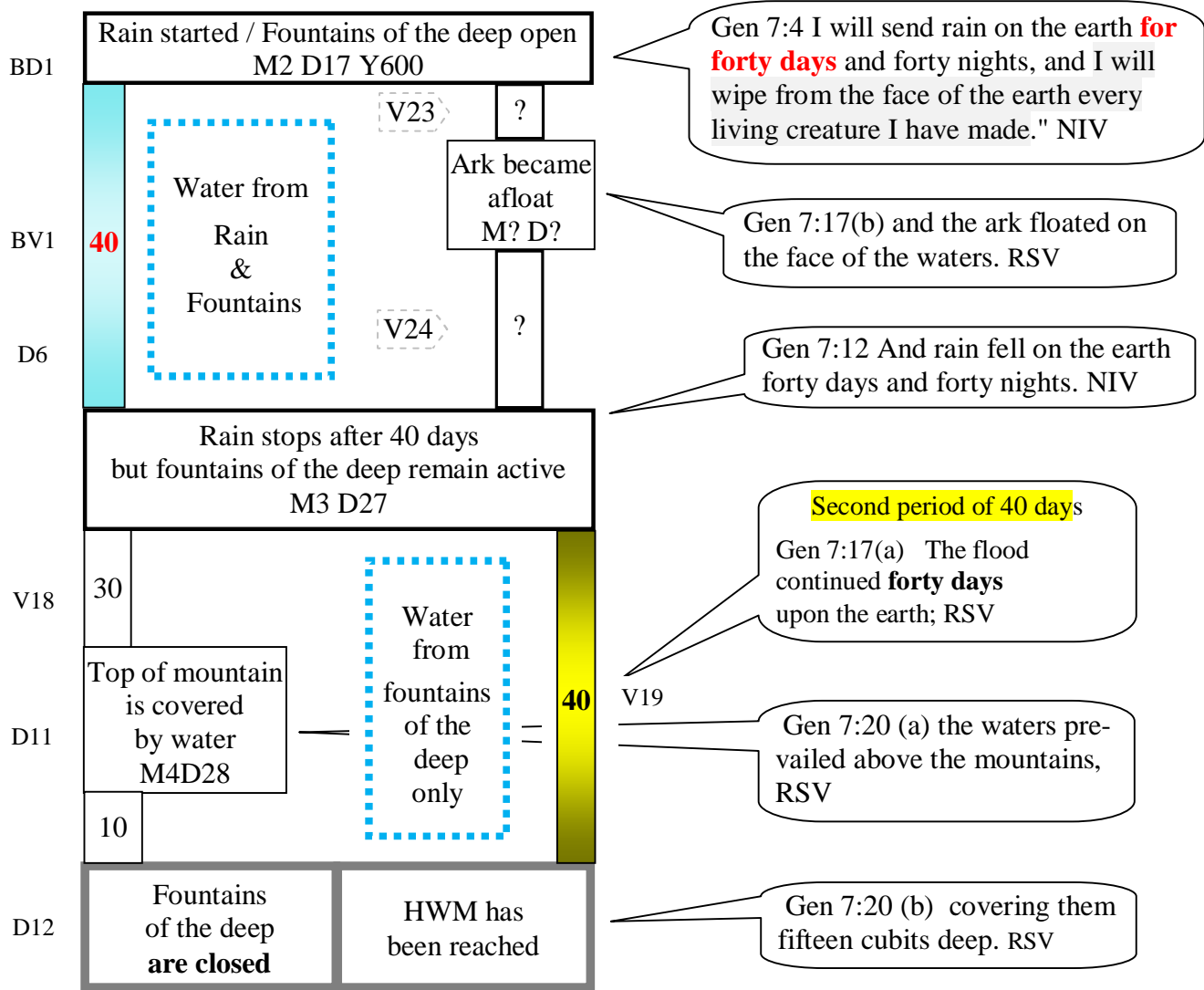

In an amazing series of videos, Rabbi David Fohrman of AlephBeta suggested that Israel Holy Ark was to God what Noah' Ark was to human.

When God destroyed the world with the Flood, that world, for a time, returned to the native conditions that exist before the creation.

- Gen 1:2 The earth was without form, and void; and darkness was on the face of the deep. And the Spirit of God was hovering over the face of the waters. NKJV

The world of the flood (a world of water) was a metaphor for God's world. Nobody could live in that world and thus everybody perished. One can then say that Noah's Ark was the only place where human were allowed to exist in God's world. Was there ever a reciprocal, i.e. a place where God has been allowed to dwell among us? Yes and that place was Ark of God.

- Lev 16:2 and the LORD said to Moses: "Tell Aaron your brother not to come at just any time into the Holy Place inside the veil, before the mercy seat which is on the ark, lest he die; for I will appear in the cloud above the mercy seat. NKJV

On the next page we will see a chiasm proposed by Rabbi Fohramn, that shows a strong connection between Noah's Ark and God's Ark (i.e. Ark of the covenant). Here the language of Exodus perfectly mirrors the language in Genesis.

A Gen 6:13 And God said to Noah, "The end of all flesh has come before Me, for the earth is filled with violence through them; and behold, I will destroy them with the earth. NKJV

Flesh occupies **one end to the other** end of the earth
All flesh will die
People are violent (to each other)

B Gen 6:14 Make yourself an ark of gopherwood; make rooms in the ark, and cover it inside and outside. NKJV

C Gen 6:14 with pitch. NKJV
A covering of dirty material, **Black absorbe the light**

D Gen 6:15 the length of the ark shall be three hundred cubits, its width fifty cubits, and its height thirty cubits.

E Gen 6:16 You shall make a **window** for the ark,

F Gen 6:17 everything that is on the earth shall die. NKJV

G1, G2,, G7

On next page we will see that the middle of this chiasm comprised 7 items (G1 to G7) which parallel (in the same order) 7 items (G1' to G7')

G1', G2',,, G7'

F' Ex 25:8 And let them make Me a sanctuary, that I may dwell among them. NKJV

E' Ex 25:9 According to all that I **show** you, NKJV

D' Ex 25:10 two and a half cubits shall be its length, a cubit and a half its width, and a cubit and a half its height.

C' Ex 25:17 of pure gold NKJV
The whole cover is in gold, **Gold reflect the light**

B' Ex 25:17 make a mercy seat NKJV

Make a cover for the ark (inside and outside of same material)

A' Ex 25:19 Make one cherub at **one end**, and the other cherub at **the other end**; you shall make the cherubim at the two ends of it of one piece with the mercy seat. Ex 25:20 and they shall face one another; NKJV

Creation of Godly being
Shall face each other (in peace)

F
L
O
O
D

G
O
D

A
R
K

G1 Gen 6:18 but I will establish My **covenant** NKJV

G2 Gen 6:19 to keep them alive with you NKJV

G3 Gen 6:21 1 And you shall take for yourself of all food that is eaten, and you shall gather it to yourself; and it shall be food for you and for them."

G4 Gen 7:4 For after seven more days NKJV

Note: 7 days without rain

G5 Gen 7:7 So Noah, with his sons, his wife, and his sons' wives, went into the ark because of the waters of the flood NKJV

Note: The Ark will protect the people

G6 Gen 7:12 And the rain was on the earth **forty days and forty nights**. NKJV

? **G7** Gen 7:17 The waters increased and lifted up the ark, and it rose high above the earth. NKJV

F
L
O
O
D

G1' Ex 24:8 "This is the blood of the **covenant** which the LORD has made with you according to all these words."

G2' Ex 24:11 1 But on the nobles of the children of Israel He did not lay His hand. So they saw God, NKJV

Note: People who saw God should have died.

G3' Ex 24:11 and they ate and drank. NKJV

G4' Ex 24:16 and the cloud covered it six days. And on the seventh day NKJV

G5' Ex 24:18 So Moses went into the midst of the cloud and went up into the mountain. NKJV

Note: God will protect Moses

G6' Ex 24:18 and Moses was on the mountain **forty days and forty nights**. NKJV

? **G7'** Ex 25:1-2 Then the LORD spoke to Moses, saying: "Speak to the children of Israel, that they bring Me an offering. [TERUMAH] NKJV

Note: terumah, literally a lift-upping

G
O
D

A
R
K

In the preceding chiasm, Rabbi Fohrman associated with good reason **G6** to the 40 days of flood and **G6'** to the 40 days Moses spent on the mountain with God.

G6 Gen 7:12 And the rain was on the earth **forty days and forty nights**. NKJV

G6' Ex 24:18 and Moses was on the mountain **forty days and forty nights**. NKJV

He then he associates **G7** with the raise of Noah's Ark and **G7'** with the offering requested by God.

G7 Gen 7:17 The waters increased and lifted up the ark, and it rose high above the earth. NKJV

G7' Ex 25:1-2 Then the LORD spoke to Moses, saying: "Speak to the children of Israel, that they bring Me an offering. [TERUMAH] NKJV
Note: terumah, literally a lift-upping

This last part of the chiasm (**G7** & **G7'**) is interesting but I have something much better to propose.

As pointed in **G6'** Moses received the initial tablets of the Ten Commandments after a period of 40 days on the mountain. But these tablets were destroyed when Moses came down the mountain; and he had to return up the mountain and spend a second period of 40 days in the cloud with God.

- Ex 34:28 So he was there with the LORD forty days and forty nights; he neither ate bread nor drank water. And He wrote on the tablets the words of the covenant, the Ten Commandments. NKJV

Wouldn't it be logical to have the chiasm's entry **G7'** point to that second period of 40 days on the mountain? Yes of course but then why did Rabbi Fohrman totally ignore it? The answer is simple. Rabbi Fohrman was not aware of the possibility that the flood water increased in two successive periods of 40 days.

Here is, deduced from my own chronology of the flood, the modification to the chiasm that I advocate.

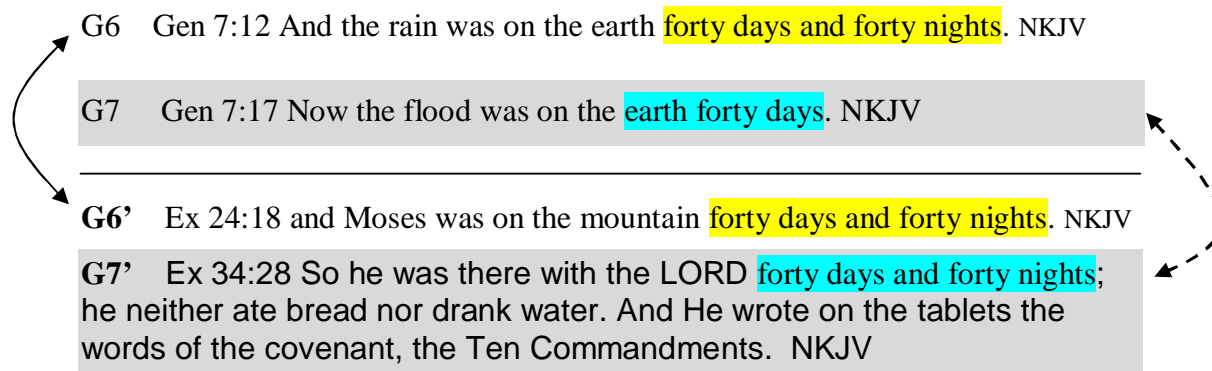

Notice: in my chronology of the flood the first period of 40 days is associated with water coming from two sources: rain and fountains of the deep while the second period is associated with water from the fountains of the deep only. Isn't it interesting that Gen 7:12 points to a period of **40 days and forty nights** while Gen 7:17 points to a period of **40 days** without any mention of a '40 nights'. Could it be a clever way to make us understand that Gen 7:17 is about a second period of 40 days, a period where half the source of water (i.e. rain from the sky) was not put to contribution anymore?

Noah flood

Moses on Sinai

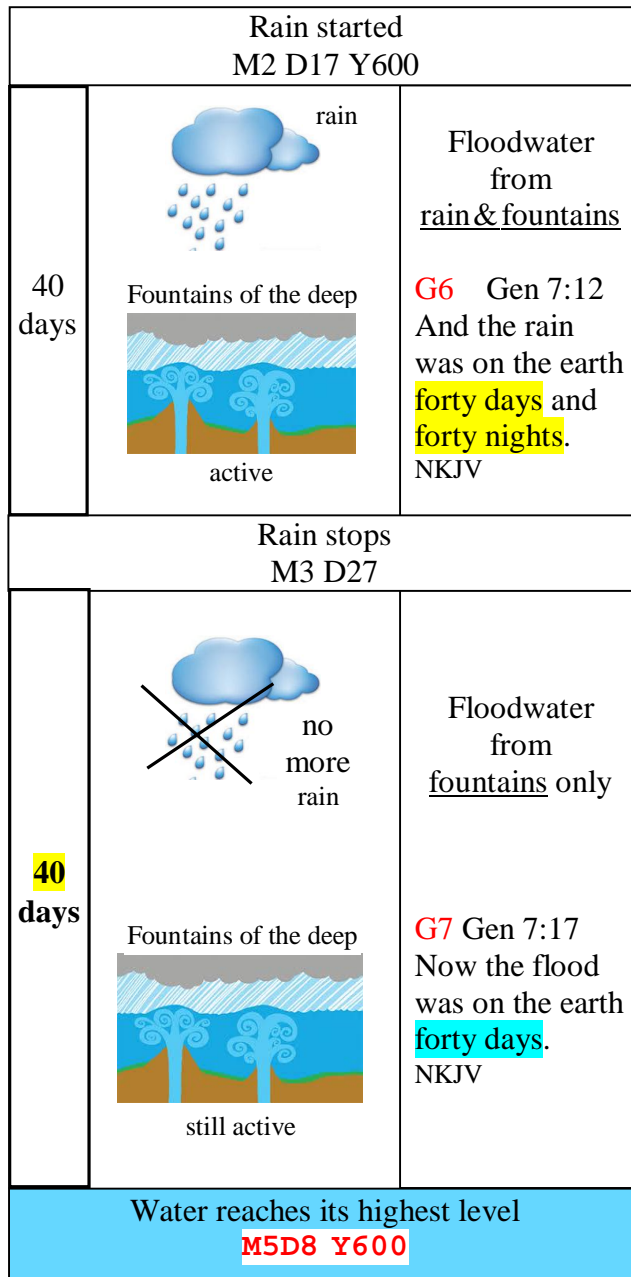

It links up with Moses **first** 40-day on mountain

It links up with Moses **second** 40-day on mountain

G6' Moses on the mountain 40 days and nights to receive God's Tablets.

Ex 24:18 and Moses was on the mountain **forty days and forty nights.** NKJV

Ex 31:18 He gave Moses two tablets of the Testimony, tablets of stone, written with the finger of God. NKJV



G7' For the second time Moses spent 40 days and nights on the mountains. Moses





Ex 34:1 1 And the LORD said to Moses, "Cut two tablets of stone like the first ones, NKJV

Ex 34:28 So he was there with the LORD **forty days and forty nights;** he neither ate bread nor drank water.

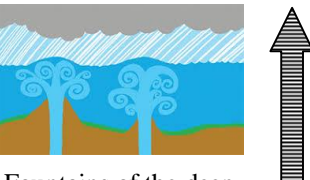
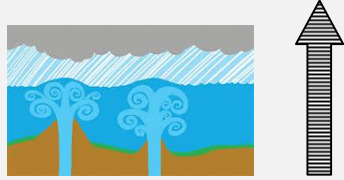
Two periods of 40 days during the Flood	<p>During the first 40 days of the Flood, the water came from the rain and the fountains of the deep.</p> <p>During the second 40 days the water came from the fountains of the deep only.</p>
---	--

Two periods of 40 days on top of Sinai	<p>The first time Moses spent forty days on the mountains, there was a thick cloud on the mountain and smoke was going up. Exo 19:16,19</p> <p>The second times Moses spent 40 days on the mountain there eas a cloud on the mountain, no mention of smoke. Exo 34:5</p>
--	--

Flood	
First 40 days	Second 40 days
  <p>rain</p>	
 <p>Fountains of the deep active</p>	 <p>Fountains of the deep still active</p>

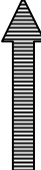
Moses on Sinai	
First 40 days	second 40 days
  <p>Thick cloud on the mountain Exo 19:16</p>	  <p>Thick cloud on the mountain Exo 34:5</p>
  <p>Smoke going up the mountain Exo 19:19</p>	

When did the Ark become afloat? The Bible doesn't say but I will make an educated guess. (Notice that in the present work, it is to be the first and only speculative number proposed.)

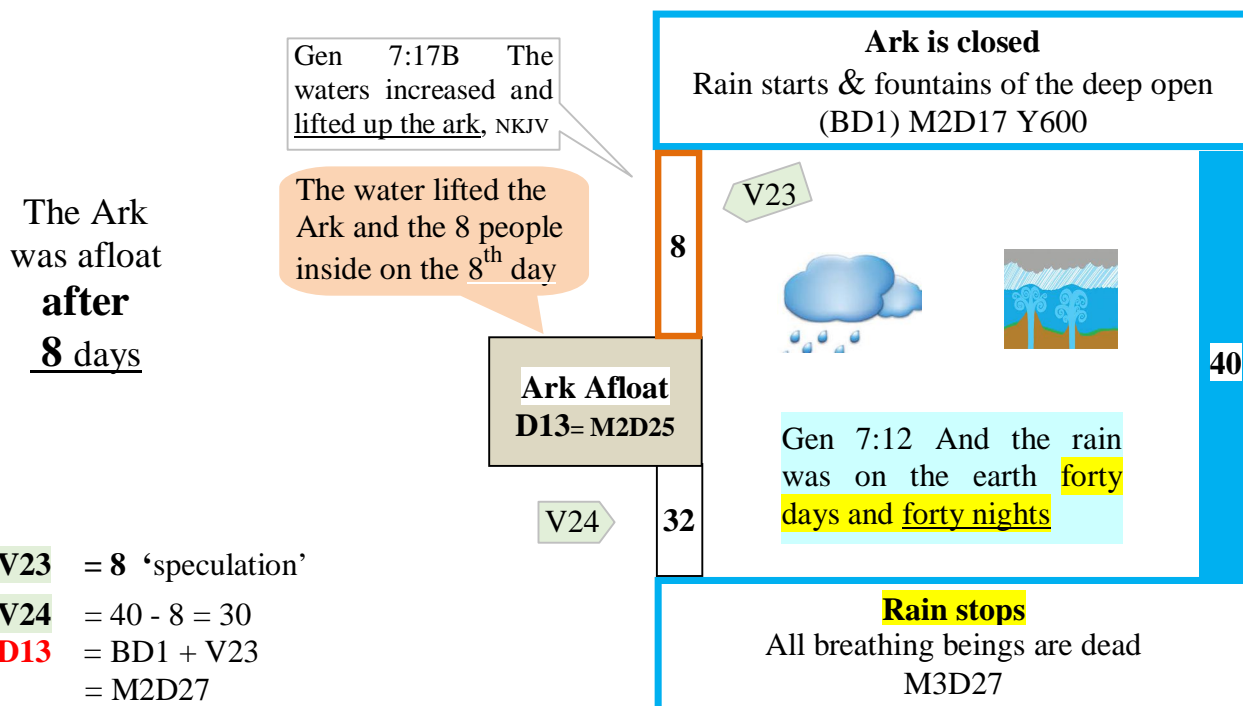

As many of us know Jewish male children are circumcised on the eighth day.

- Gen 17:11-12 You are to undergo circumcision, and it will be the sign of the covenant between me and you. For the generations to come every male among you who is eight days old must be circumcised, NIV

Is it possible that the 8 days associated to the ritual of circumcision, was a symbolic reminder of a similar length of time during which Noah and his family were anxiously waiting for the Ark to raise? Is there any similarities between the two situation?

As long as the Ark was aground Noah and his family were still part of the sinning world

- Gen 6:5-6 The LORD saw how great man's wickedness on the earth had become, and that every inclination of the thoughts of his heart was only evil all the time. 6 The LORD was grieved that he had made man on the earth, and his heart was filled with pain. NIV

It is only when the Ark became afloat that a genuine physical separation took place between the antediluvian sinners and the eight occupants of the boat. (at the very instant the Ark became afloat Noah and his family had the ultimate confirmation that they were saved from drowning, it didn't matter anymore that the water of the flood was still rising, the boat would raise at the same speed)

Circumcision involves "cutting off" of the flesh, in others words "separating the flesh" to become part of God's Covenant. Circumcision is delayed to the eighth day, as if to say that is the very first time when the male child may symbolically be dedicated to the service of God.

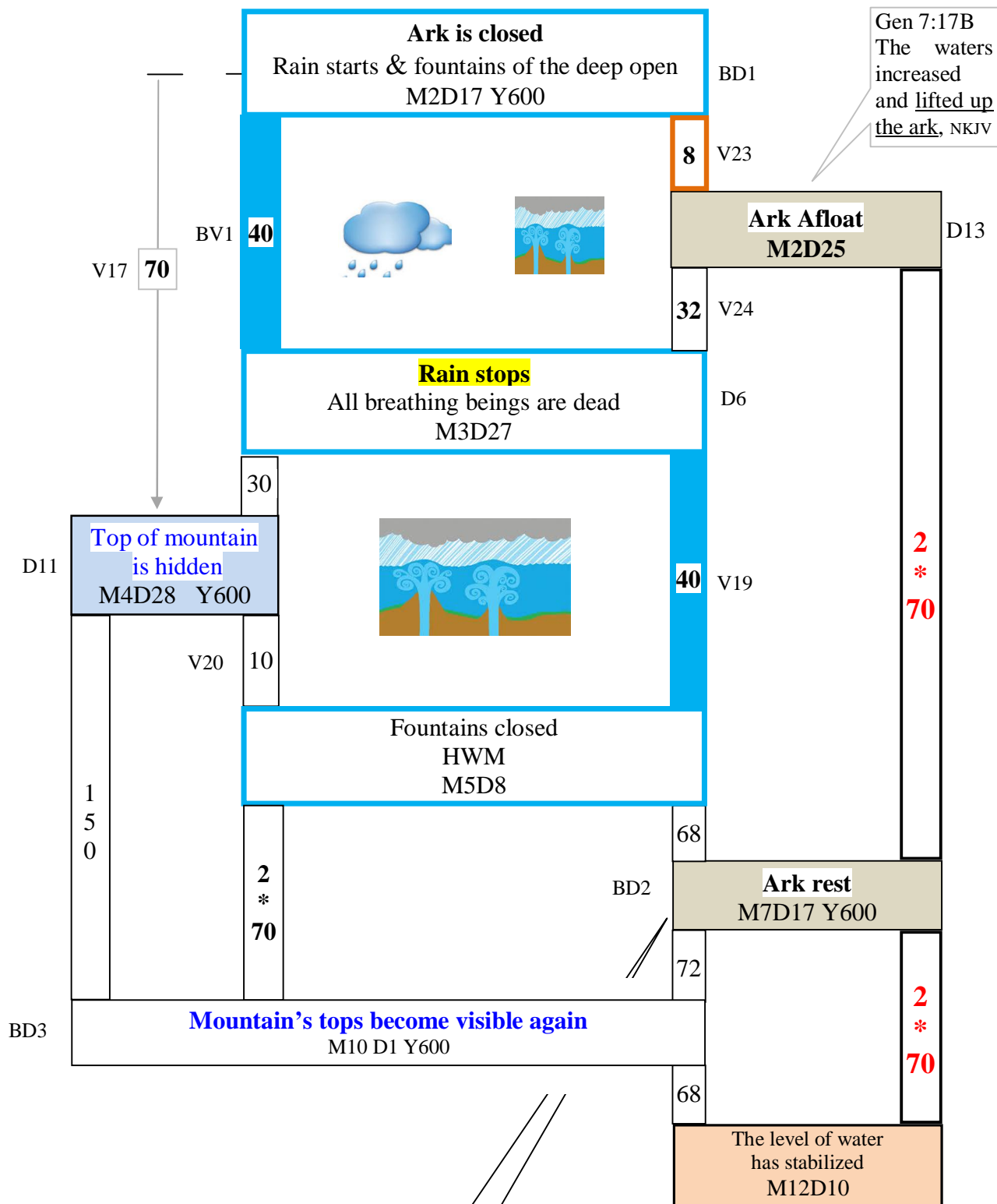

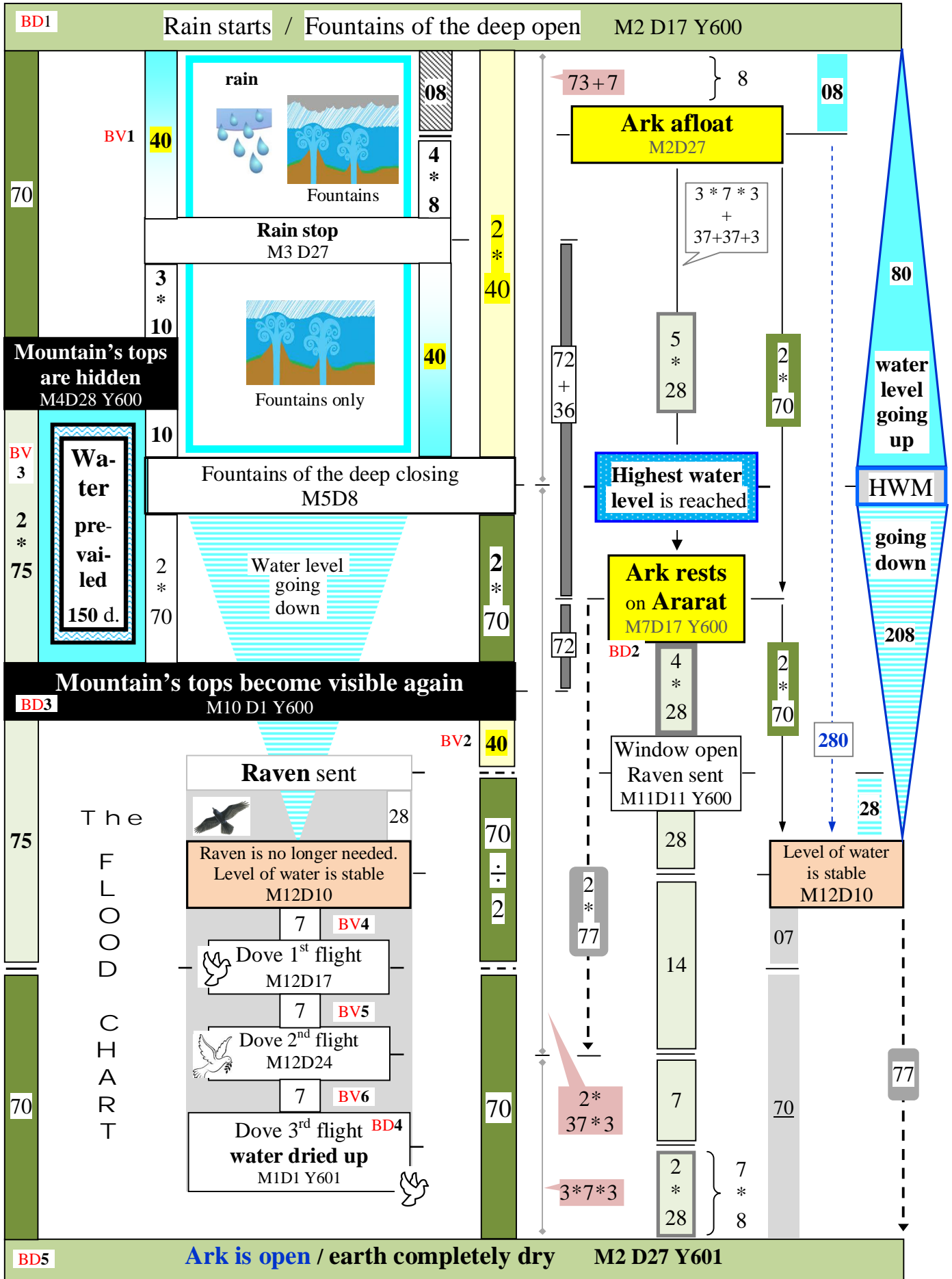

After 365 years, Enoch was removed and did not have to experience death.

- Gen 5:24 **Enoch walked with God**; then he was no more, because God took him away. NIV

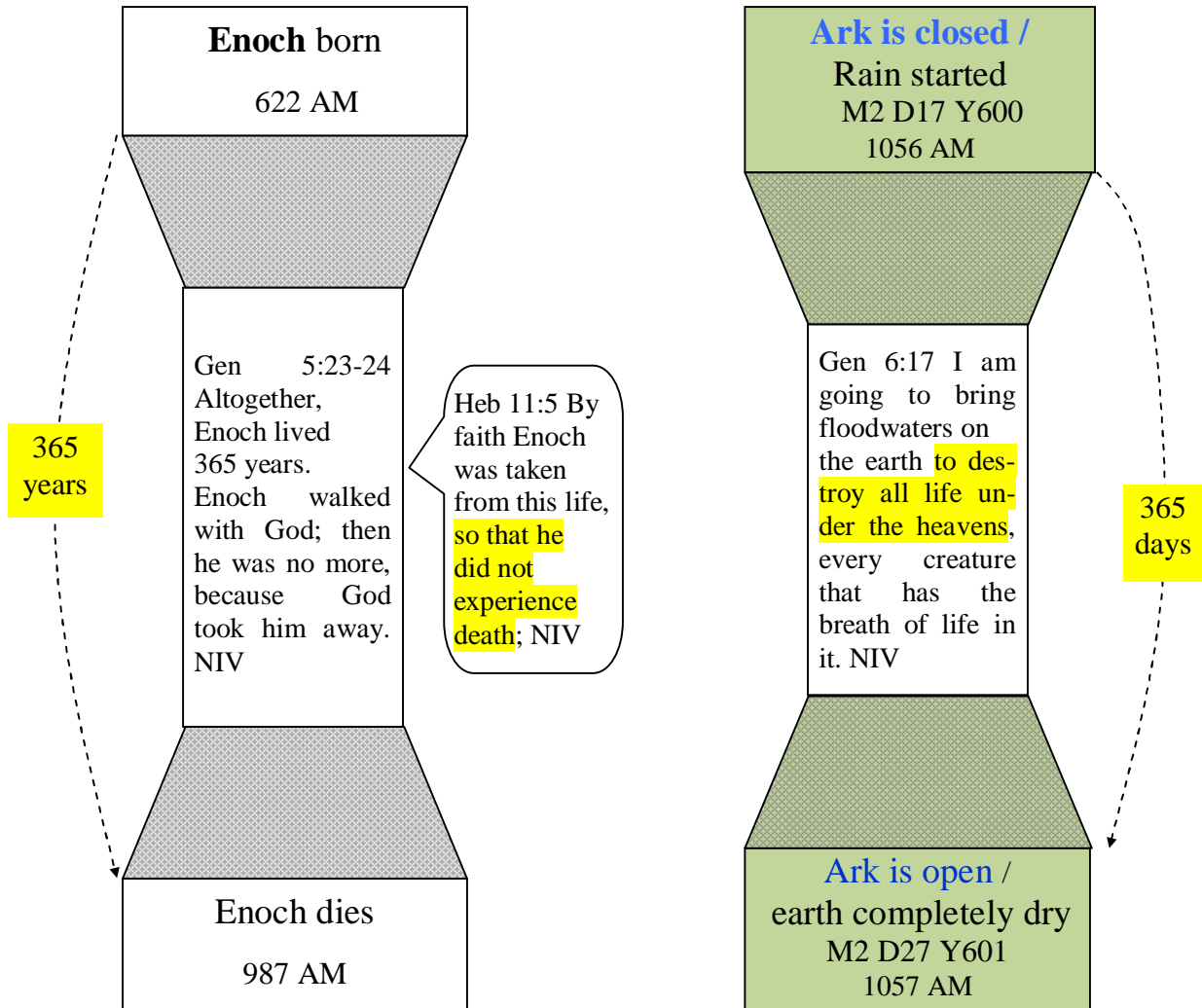

During 365 days Noah was removed and did not have to experience death.

- Gen 6:9 **Noah** was a righteous man, blameless among the people of his time, and **he walked with God**. NIV

The calendar on the next page is a tool to help those readers who would like to validate any date or value mentioned previously.

The range of this calendar is from the first day of the second month of year 1656 AM (year of the flood) to the 29th day of the second month of year 1657 AM. The label AM associated with the year means Anno Mundi; in this system's notation Adam was created in year 0 AM while the flood came in 1656 AM.

In each case of the calendar the following information will be found:

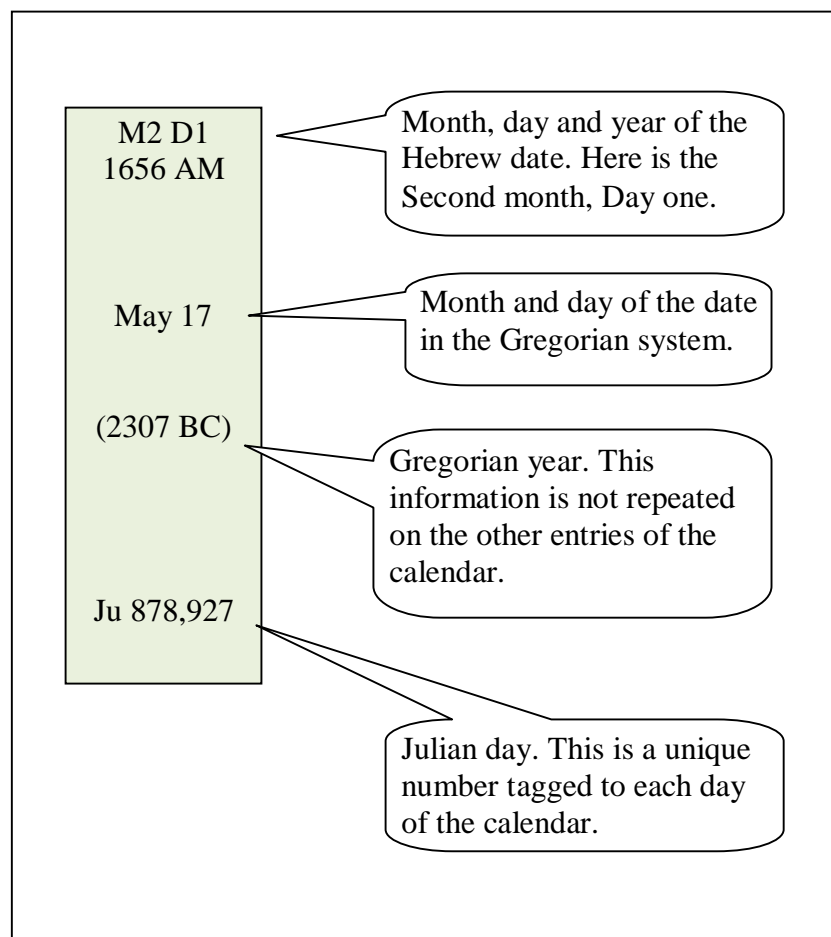

NOTE 1: In this calendar, the first day of each Hebrew month (D1) coincides with the timing of the new moon. The information was obtained from the Planetarium Software (Redshift).

Note 2: It is not the intent of the author to suggest that the calendar should start on any specific day of the week. This information is not known and if it was, it would not have any impact on the length of time between any events featured in this study.

Here is how the calendar can be used:

Example 1

Suppose you want to know how many days there are between
M2D17 (when the Ark was closed) and
M7D17 (when the Ark came to rest on Mount Ararat)

You need to spot the following two entries of the calendar

M2D17
2
Ju 878,943

M7D17
28
Ju 879,091

The number of days between the two dates is given by subtracting the two Julian days' values

$$\text{Ju } 879,091 - \text{Ju } 878,943 = 148 \text{ days}$$

Example 2

Suppose you want to find out the date when Noah opened the window of the Ark.

The Bible tells us it was 40 days after the top of the mountain became visible on the first day of the 10th month.

First step: Find the calendar entry for M10D1

Second step: Add 40 to the Julian day $\text{Ju } 879,163 = \text{Ju } 879,203$

Third step: Find the calendar entry for $\text{Ju } 879,203$

Answer: Noah opened the window of the Ark on the 11th day of the 11th month in the year 1656 AM.

The flood calendar

From 1656 AM to 1657 AM (from 2307 BC to 2306 BC)

				Apr 9 EQ	Apr 10	Apr 11
Apr 12	Apr 13	Apr 14	Apr 15	Apr 16	Apr 17	M1D1 April 18 Ju 878,898
M1D2 19 Ju 878,899	M1D3 20 Ju 878,900	M1D4 21 Ju 878,901	M1D5 22 Ju 878,902	M1D6 23 Ju 878,903	M1D7 24 Ju 878,904	M1D8 25 Ju 878,905
M1D9 26 Ju 878,906	M1D10 27 Ju 878,907	M1D11 28 Ju 878,908	M1D12 29 Ju 878,909	M1D13 30 Ju 878,910	M1D14 May 1 Ju 878,911	M1D15 2 Ju 878,912
M1D16 3 Ju 878,913	M1D17 4 Ju 878,914	M1D18 5 Ju 878,915	M1D19 6 Ju 878,916	M1D20 7 Ju 878,917	M1D21 8 Ju 878,918	M1D22 9 Ju 878,919
M1D23 10 Ju 878,920	M1D24 11 Ju 878,921	M1D25 12 Ju 878,922	M1D26 13 Ju 878,923	M1D27 14 Ju 878,924	M1D28 15 Ju 878,925	M1D29 16 Ju 878,926
M2 D1 1656 AM May 17 (2307 BC) Ju 878,927	M2 D2 18 Ju 878,928	M2 D3 19 Ju 878,929	M2 D4 20 Ju 878,930	M2 D5 21 Ju 878,931	M2 D6 22 Ju 878,932	M2 D7 23 Ju 878,933
M2 D8 24 Ju 878,934	M2 D9 25 Ju 878,935	M2 D10 26 Ju 878,936	M2 D11 27 Ju 878,937	M2 D12 28 Ju 878,938	M2 D13 29 Ju 878,939	M2 D14 30 Ju 878,940
M2 D15 31 Ju 878,941	M2 D16 June 1 Ju 878,942	M2 D17 2 Ju 878,943	M2 D18 3 Ju 878,944	M2 D19 4 Ju 878,945	M2 D20 5 Ju 878,946	M2 D21 6 Ju 878,947

M2 D22 7 Ju 878,948	M2 D23 8 Ju 878,949	M2 D24 9 Ju 878,950	M2 D25 10 Ju 878,951	M2 D26 11 Ju 878,952	M2 D27 12 Ju 878,953	M2 D28 13 Ju 878,954
M2 D29 14 Ju 878,955	M2 D30 15 Ju 878,956	M3 D1 16 Ju 878,957	M3 D2 17 Ju 878,958	M3 D3 18 Ju 878,959	M3 F4 19 Ju 878,960	M3 D5 20 Ju 878,961
M3 D6 21 Ju 878,962	M3 D7 22 Ju 878,963	M3 D8 23 Ju 878,964	M3 D9 24 Ju 878,965	M3 D10 25 Ju 878,966	M3 D11 26 Ju 878,967	M3 D12 27 Ju 878,968
M3 D13 28 Ju 878,969	M3 D14 29 Ju 878,970	M3 D15 30 Ju 878,971	M3 D16 July 1 Ju 878,972	M3 D17 2 Ju 878,973	M3 D18 3 Ju 878,974	M3 D19 4 Ju 878,975
M3 D20 5 Ju 878,976	M3 D21 6 Ju 878,977	M3 D22 7 Ju 878,978	M3 D23 8 Ju 878,979	M3 D24 9 Ju 878,980	M3 D25 10 Ju 878,981	M3 D26 11 Ju 878,982
M3 D27 12 Ju 878,983	M3 D28 13 Ju 878,984	M3 D29 14 Ju 878,985	M4 D1 15 Ju 878,986	M4 D2 16 Ju 878,987	M4 D3 17 Ju 878,988	M4 D4 18 Ju 878,989
M4 D5 19 Ju 878,990	M4 D6 20 Ju 878,991	M4 D7 21 Ju 878,992	M4 D8 22 Ju 878,993	M4 D9 23 Ju 878,994	M4 D10 24 Ju 878,995	M4 D11 25 Ju 878,996
M4 D12 26 Ju 878,997	M4 D13 27 Ju 878,998	M4 D14 28 Ju 878,999	M4 D15 29 Ju 879,000	M4 D16 30 Ju 879,001	M4 D17 31 Ju 879,002	M4 D18 August 1 Ju 879,003
M4 D19 2 Ju 879,004	M4 D20 3 Ju 879,005	M4 D21 4 Ju 879,006	M4 D22 5 Ju 879,007	M4 D23 6 Ju 879,008	M4 D24 7 Ju 879,009	M4 D25 8 Ju 879,010
M4 D26 9 Ju 879,011	M4 D27 10 Ju 879,012	M4 D28 11 Ju 879,013	M4 D29 12 Ju 879,014	M4 D30 13 Ju 879,015	M5 D1 14 Ju 879,016	M5 D2 15 Ju 879,017
M5 D3 16 Ju 879,018	M5 D4 17 Ju 879,019	M5 D5 18 Ju 879,020	M5 D6 19 Ju 879,021	M5 D7 20 Ju 879,022	M5 D8 21 Ju 879,023	M5 D9 22 Ju 879,024
M5 D10 23 Ju 879,025	M5 D11 24 Ju 879,026	M5 D12 25 Ju 879,027	M5 D13 26 Ju 879,028	M5 D14 27 Ju 879,029	M5 D15 28 Ju 879,030	M5 D16 29 Ju 879,031
M5 D17 30 Ju 879,032	M5 D18 31 Ju 879,033	M5 D19 Sept. 1 Ju 879,034	M5 D20 2 Ju 879,035	M5 D21 3 Ju 879,036	M5 D22 4 Ju 879,037	M5 D23 5 Ju 879,038

M5 D24 6 Ju 879,039	M5 D25 7 Ju 879,040	M5 D26 8 Ju 879,041	M5 D27 9 Ju 879,042	M5 D28 10 Ju 879,043	M5 D29 11 Ju 879,044	M6 D1 12 Ju 879,045
M6 D2 13 Ju 879,046	M6 D3 14 Ju 879,047	M6 D4 15 Ju 879,048	M6 D5 16 Ju 879,049	M6 D6 17 Ju 879,050	M6 D7 18 Ju 879,051	M6 D8 19 Ju 879,052
M6 D9 20 Ju 879,053	M6 D10 21 Ju 879,054	M6 D11 22 Ju 879,055	M6 D12 23 Ju 879,056	M6 D13 24 Ju 879,057	M6 D14 25 Ju 879,058	M6 D15 26 Ju 879,059
M6 D16 27 Ju 879,060	M6 D17 28 Ju 879,061	M6 D18 29 Ju 879,062	M6 D19 30 Ju 879,063	M6 D20 Oct. 1 Ju 879,064	M6 D21 2 Ju 879,065	M6 D22 3 Ju 879,066
M6 D23 4 Ju 879,067	M6 D24 5 Ju 879,068	M6 D25 6 Ju 879,069	M6 D26 7 Ju 879,070	M6 D27 8 Ju 879,071	M6 D28 9 Ju 879,072	M6 D29 10 Ju 879,073
M6 D30 11 Ju 879,074	M7 D1 12 Ju 879,075	M7 D2 13 Ju 879,076	M7 D3 14 Ju 879,077	M7 D4 15 Ju 879,078	M7 D5 16 Ju 879,079	M7 D6 17 Ju 879,080
M7 D7 18 Ju 879,081	M7 D8 19 Ju 879,082	M7 D9 20 Ju 879,083	M7 D10 21 Ju 879,084	M7 D11 22 Ju 879,085	M7 D12 23 Ju 879,086	M7 D13 24 Ju 879,087
M7 D14 25 Ju 879,088	M7 D15 26 Ju 879,089	M7 D16 27 Ju 879,090	M7 D17 28 Ju 879,091	M7 D18 29 Ju 879,092	M7 D19 30 Ju 879,093	M7 D20 31 Ju 879,094
M7 D21 Nov. 1 Ju 879,095	M7 D22 2 Ju 879,096	M7 D23 3 Ju 879,097	M7 D24 4 Ju 879,098	M7 D25 5 Ju 879,099	M7 D26 6 Ju 879,100	M7 D27 7 Ju 879,101
M7 D28 8 Ju 879,102	M7 D29 9 Ju 879,103	M8 D1 10 Ju 879,104	M8 D2 11 Ju 879,105	M8 D3 12 Ju 879,106	M8 D4 13 Ju 879,107	M8 D5 14 Ju 879,108
M8 D6 15 Ju 879,109	M8 D7 16 Ju 879,110	M8 D8 17 Ju 879,111	M8 D9 18 Ju 879,112	M8 D10 19 Ju 879,113	M8 D11 20 Ju 879,114	M8 D12 21 Ju 879,115
M8 D13 22 Ju 879,116	M8 D14 23 Ju 879,117	M8 D15 24 Ju 879,118	M8 D16 25 Ju 879,119	M8 D17 26 Ju 879,120	M8 D18 27 Ju 879,121	M8 D19 28 Ju 879,122
M8 D20 29 Ju 879,123	M8 D21 30 Ju 879,124	M8 D22 Dec. 1 Ju 879,125	M8 D23 2 Ju 879,126	M8 D24 3 Ju 879,127	M8 D25 4 Ju 879,128	M8 D26 5 Ju 879,129

M8 D27 6 Ju 879,130	M8 D28 7 Ju 879,131	M8 D29 8 Ju 879,132	M8 D30 9 Ju 879,133	M9 D1 10 Ju 879,134	M9 D2 11 Ju 879,135	M9 D3 12 Ju 879,136
M9 D4 13 Ju 879,137	M9 D5 14 Ju 879,138	M9 D6 15 Ju 879,139	M9 D7 16 Ju 879,140	M9 D8 17 Ju 879,141	M9 D9 18 Ju 879,142	M9 D10 19 Ju 879,143
M9 D11 20 Ju 879,144	M9 D12 21 Ju 879,145	M9 D13 22 Ju 879,146	M9 D14 23 Ju 879,147	M9 D15 24 Ju 879,148	M9 D16 25 Ju 879,149	M9 D17 26 Ju 879,150
M9 D18 27 Ju 879,151	M9 D19 28 Ju 879,152	M9 D20 29 Ju 879,153	M9 D21 30 Ju 879,154	M9 D22 31 Ju 879,155	M9 D23 Jan. 1 2306 BC Ju 879,156	M9 D24 2 Ju 879,157
M9 D25 3 Ju 879,158	M9 D26 4 Ju 879,159	M9 D27 5 Ju 879,160	M9 D28 6 Ju 879,161	M9 D29 7 Ju 879,162	M10 D1 8 Ju 879,163	M10 D2 9 Ju 879,164
M10 D3 10 Ju 879,165	M10 D4 11 Ju 879,166	M10 D5 12 Ju 879,167	M10 D6 13 Ju 879,168	M10 D7 14 Ju 879,169	M10 D8 15 Ju 879,170	M10 D9 16 Ju 879,171
M10 D10 17 Ju 879,172	M10 D11 18 Ju 879,173	M10 D12 19 Ju 879,174	M10 D13 20 Ju 879,175	M10 D14 21 Ju 879,176	M10 D15 22 Ju 879,177	M10 D16 23 Ju 879,178
M10 D17 24 Ju 879,179	M10 D18 25 Ju 879,180	M10 D19 26 Ju 879,181	M10 D20 27 Ju 879,182	M10 D21 28 Ju 879,183	M10 D22 29 Ju 879,184	M10 D23 30 Ju 879,185
M10 D24 31 Ju 879,186	M10 D25 Feb. 1 Ju 879,187	M10 D26 2 Ju 879,188	M10 D27 3 Ju 879,189	M10 D28 4 Ju 879,190	M10 D29 5 Ju 879,191	M10 D30 6 Ju 879,192
M11 D1 7 Ju 879,193	M11 D2 8 Ju 879,194	M11 D3 9 Ju 879,195	M11 D4 10 Ju 879,196	M11 D5 11 Ju 879,197	M11 D6 12 Ju 879,198	M11 D7 13 Ju 879,199
M11 D8 14 Ju 879,200	M11 D9 15 Ju 879,201	M11 D10 16 Ju 879,202	M11 D11 17 Ju 879,203	M11 D12 18 Ju 879,204	M11 D13 19 Ju 879,205	M11 D14 20 Ju 879,206
M11 D15 21 Ju 879,207	M11 D16 22 Ju 879,208	M11 D17 23 Ju 879,209	M11 D18 24 Ju 879,210	M11 D19 25 Ju 879,211	M11 D20 26 Ju 879,212	M11 D21 27 Ju 879,213

M11 D22 28 Ju 879,214	M11 D23 March 1 Ju 879,215	M11 D24 2 Ju 879,216	M11 D25 3 Ju 879,217	M11 D26 4 Ju 879,218	M11 D27 5 Ju 879,219	M11 D28 6 Ju 879,220
M11 D29 7 Ju 879,221	M12 D1 8 Ju 879,222	M12 D2 9 Ju 879,223	M12 D3 10 Ju 879,224	M12 D4 11 Ju 879,225	M12 D5 12 Ju 879,226	M12 D6 13 Ju 879,227
M12 D7 14 Ju 879,228	M12 D8 15 Ju 879,229	M12 D9 16 Ju 879,230	M12 D10 17 Ju 879,231	M12 D11 18 Ju 879,232	M12 D12 19 Ju 879,233	M12 D13 20 Ju 879,234
M12 D14 21 Ju 879,235	M12 D15 22 Ju 879,236	M12 D16 23 Ju 879,237	M12 D17 24 Ju 879,238	M12 D18 25 Ju 879,239	M12 D19 26 Ju 879,240	M12 D20 27 Ju 879,241
M12 D21 28 Ju 879,242	M12 D22 29 Ju 879,243	M12 D23 30 Ju 879,244	M12 D24 31 Ju 879,245	M12 D25 April 1 Ju 879,246	M12 D26 2 Ju 879,247	M12 D27 3 Ju 879,248
M12 D28 4 Ju 879,249	M12 D29 5 Ju 879,250	M12 D30 6 Ju 879,251	M1 D1 Y1657 AM 7 Ju 879,252	M1 D2 8 Ju 879,253	M1 D3 9 EQ Ju 879,254	M1 D4 10 Ju 879,255
M1 D5 11 Ju 879,256	M1 D6 12 Ju 879,257	M1 D7 13 Ju 879,258	M1 D8 14 Ju 879,259	M1 D9 15 Ju 879,260	M1 D10 16 Ju 879,261	M1 D11 17 Ju 879,262
M1 D12 18 Ju 879,263	M1 D13 19 Ju 879,264	M1 D14 20 Ju 879,265	M1 D15 21 Ju 879,266	M1 D16 22 Ju 879,267	M1 D17 23 Ju 879,268	M1 D18 24 Ju 879,269
M1 D19 25 Ju 879,270	M1 D20 26 Ju 879,271	M1 D21 27 Ju 879,272	M1 D22 28 Ju 879,273	M1 D23 29 Ju 879,274	M1 D24 30 Ju 879,275	M1 D25 May 1 Ju 879,276
M1 D26 2 Ju 879,277	M1 D27 3 Ju 879,278	M1 D28 4 Ju 879,279	M1 D29 5 Ju 879,280	M1 D30 6 Ju 879,281	M2 D1 7 Ju 879,282	M2 D2 8 Ju 879,283
M2 D3 9 Ju 879,284	M2 D4 10 Ju 879,285	M2 D5 11 Ju 879,286	M2 D6 12 Ju 879,287	M2 D7 13 Ju 879,288	M2 D8 14 Ju 879,289	M2 D9 15 Ju 879,290
M2 D10 16 Ju 879,291	M2 D11 17 Ju 879,292	M2 D12 18 Ju 879,293	M2 D13 19 Ju 879,294	M2 D14 20 Ju 879,295	M2 D15 21 Ju 879,296	M2 D16 22 Ju 879,297

M2 D17 23 Ju 879,298	M2 D18 24 Ju 879,299	M2 D19 25 Ju 879,300	M2 D20 26 Ju 879,301	M2 D21 27 Ju 879,302	M2 D22 28 Ju 879,303	M2 D23 29 Ju 879,304
M2 D24 30 Ju 879,305	M2 D25 31 Ju 879,306	M2 D26 June 1 Ju 879,307	M2 D27 2 Ju 879,308	M2 D28 3 Ju 879,309	M2 D29 4 Ju 879,310	M3 D1 5 Ju 879,311

This paper is followed by “**The Flight of Noah’s Raven**”.

Yves Peloquin