

U18F -40

Competitors/Compétiteurs

#	Name/Nom	Grade	Club	1	2	1	2	1	2	W/G	Pts	Pos
1	BELLANCE Loryn (0,00)	1d	France/PÃ´le Montpellier	XX	10	XX	10	XX		2	20	1
2	HILLER Harlee (0,00)	2k+	USA/Cohen Brothers		XX		XX		XX	0	0	2

Matches/Matches

Match	White/Blanc			Blue/Bleu	Res/Rés	Tim/Tmp	Code
A-51	BELLANCE Loryn	1	2	HILLER Harlee	10 - 0	2:14	IPO
A-60	HILLER Harlee	2	1	BELLANCE Loryn	0 - 10	0:43	IPO
A-65	BELLANCE Loryn	1	2	HILLER Harlee			

Results/Résultats

Pos	Name/Nom
1	BELLANCE Loryn, France/PÃ´le Montpellier

U18F -52

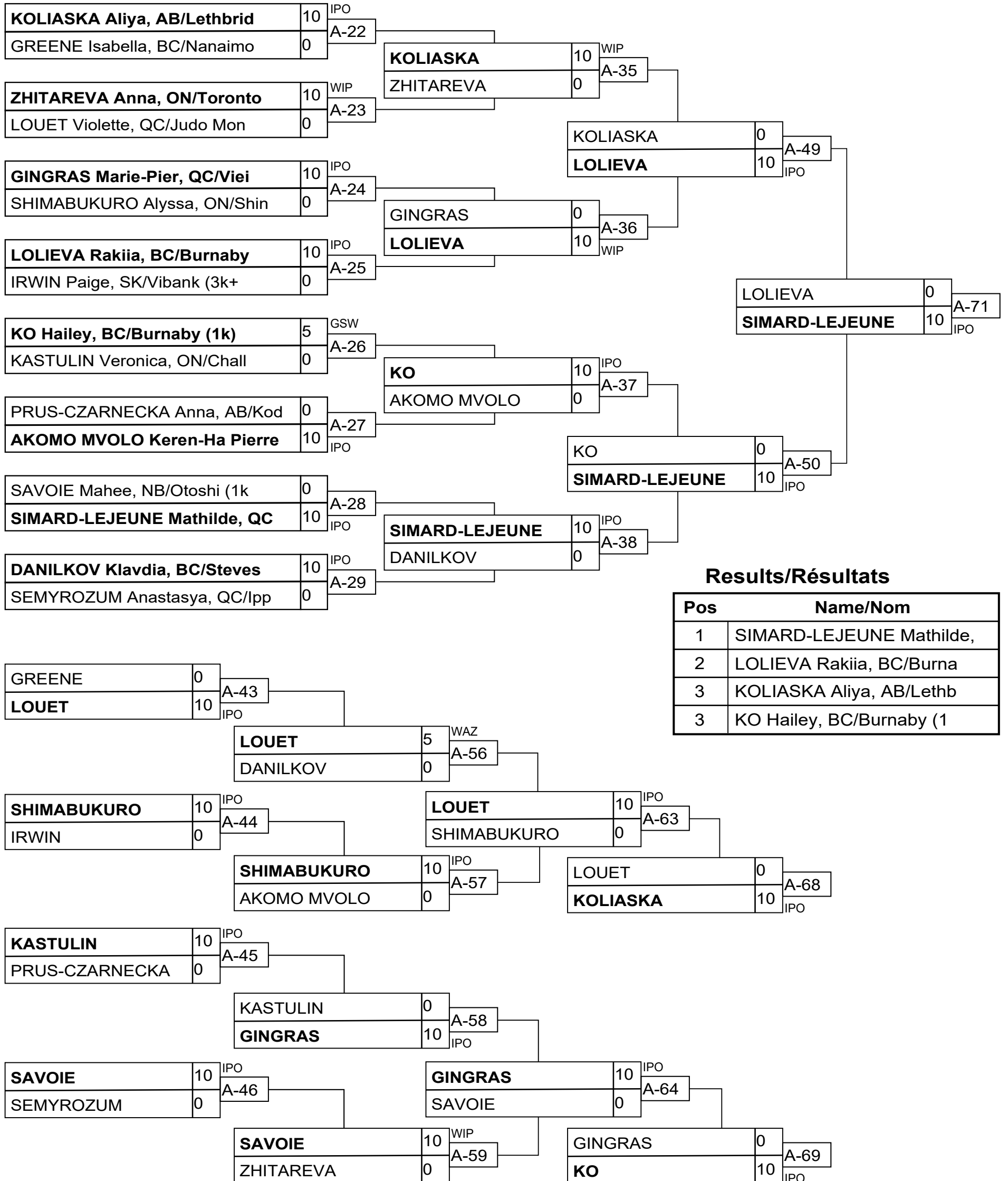

Results/Résultats

Pos	Name/Nom
1	SIMARD-LEJEUNE Mathilde,
2	LOLIEVA Rakiia, BC/Burna
3	KOLIASKA Aliya, AB/Lethb
3	KO Hailey, BC/Burnaby (1

U18F +70

Competitors/Compétiteurs A

#	Name/Nom	Grade	Club	1	2	3	4	W/G	Pts	Pos
1	WEBB Dakota (0,00)	2k	BC/Kokushikai	XX				0	0	4
2	KEAYS Jannessa (0,00)	2k	SK/Saskatoon Y	10	XX	5		2	15	2
3	SAHRAOUI Maya (0,00)	1k	QC/Blainville	10		XX		1	10	3
4	LEFEBVRE Elodie (0,00)	2k	QC/Asbestos-Danville	10	10	10	XX	3	30	1

Matches/Matches A

Match	White/Blanc	Blue/Bleu	Res/Rés	Tim/Tmp	Code
D-37	WEBB Dakota 1 2	KEAYS Jannessa	0 - 10	0:09	KIK
D-38	SAHRAOUI Maya 3 4	LEFEBVRE Elodie	0 - 10	1:42	WIP
D-46	WEBB Dakota 1 3	SAHRAOUI Maya	0 - 10	0:00	FUS
D-47	KEAYS Jannessa 2 4	LEFEBVRE Elodie	0 - 10	0:06	IPO
D-53	WEBB Dakota 1 4	LEFEBVRE Elodie	0 - 10	0:00	FUS
D-54	KEAYS Jannessa 2 3	SAHRAOUI Maya	5 - 0	3:20	GSW

Competitors/Compétiteurs B

#	Name/Nom	Grade	Club	5	6	7	W/G	Pts	Pos
5	FOREST Frederique (0,00)	2k	QC/Kiseki	XX			0	0	3
6	DOUGLAS Asia (0,00)	1k	ON/Toronto Judo Kai	10	XX	10	2	20	1
7	LINGLEY Brandi (0,00)	2k	NB/Tani Koi	10		XX	1	10	2

Matches/Matches B

Match	White/Blanc	Blue/Bleu	Res/Rés	Tim/Tmp	Code
D-39	FOREST Frederique 5 6	DOUGLAS Asia	0 - 10	0:20	WIP
D-48	FOREST Frederique 5 7	LINGLEY Brandi	0 - 10	0:10	IPO
D-55	DOUGLAS Asia 6 7	LINGLEY Brandi	10 - 0	0:46	IPO

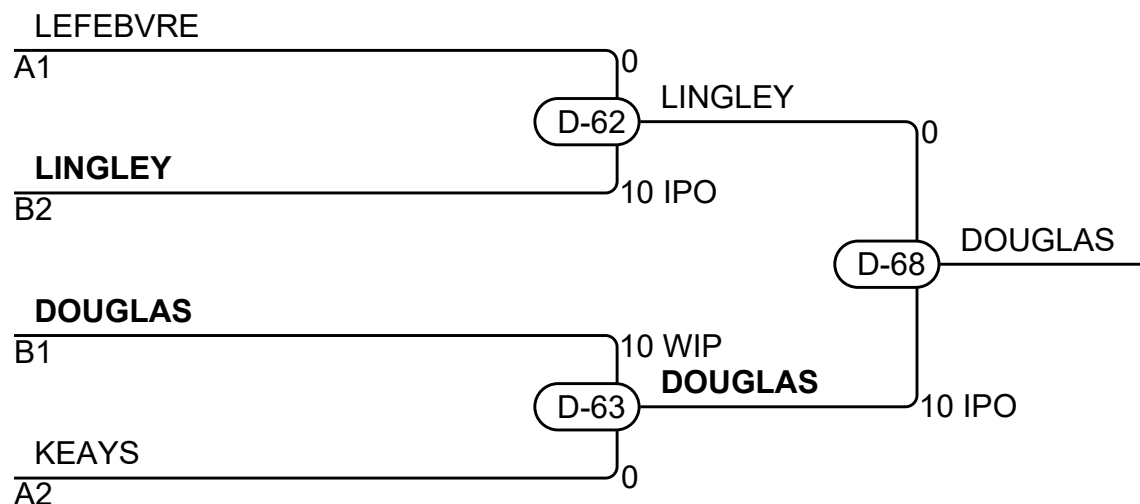

Results/Résultats

Pos	Name/Nom
1	DOUGLAS Asia, ON/Toronto Judo Kai
2	LINGLEY Brandi, NB/Tani Koi
3	LEFEBVRE Elodie, QC/Asbestos-Danville
3	KEAYS Jannessa, SK/Saskatoon Y

U18M -46

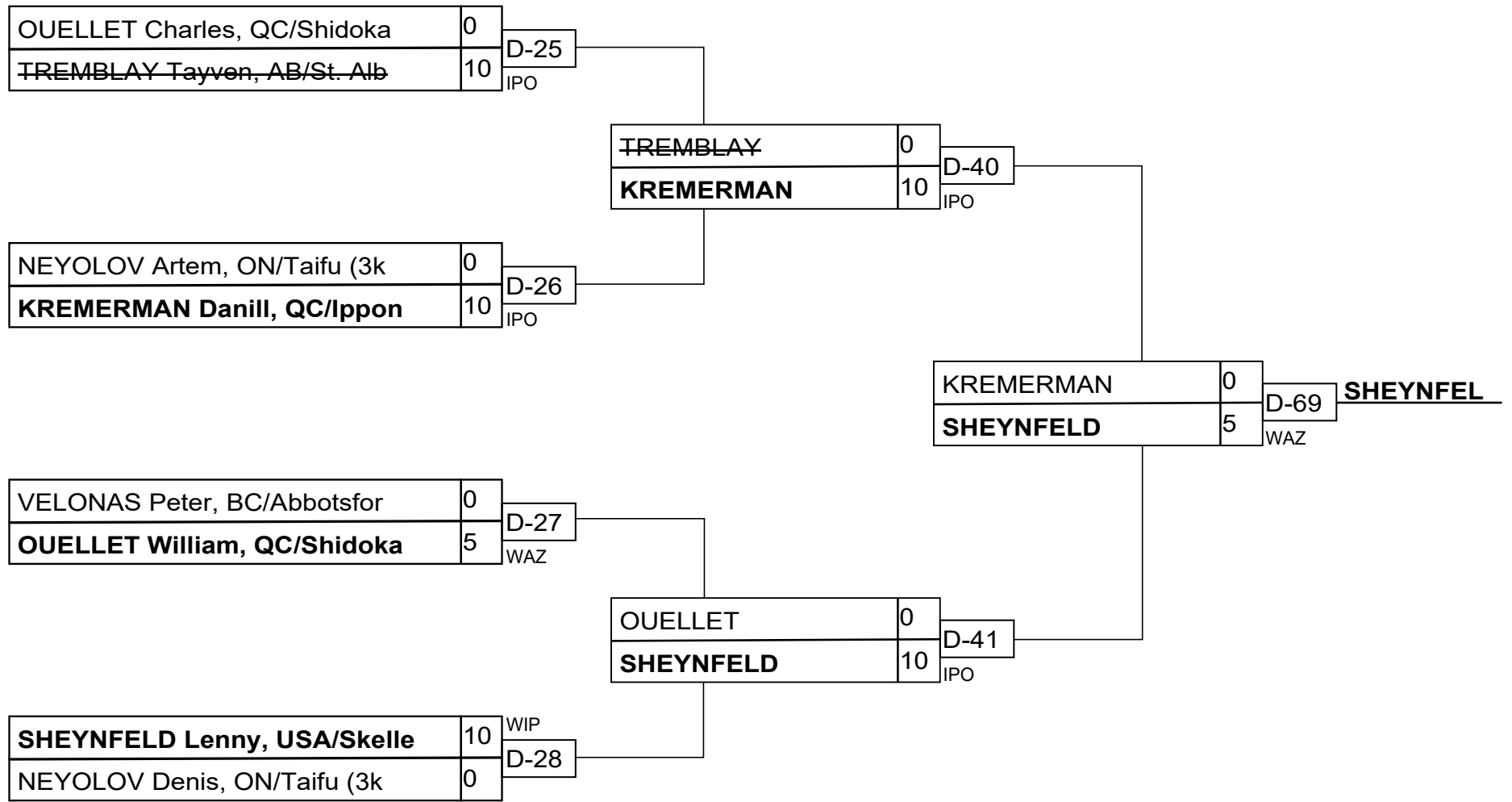

Results/Résultats

Pos	Name/Nom
1	SHEYNFELD Lenny, USA/Ske
2	KREMERMANN Danill, QC/lpp
3	
3	OUELLET Charles, QC/Shid

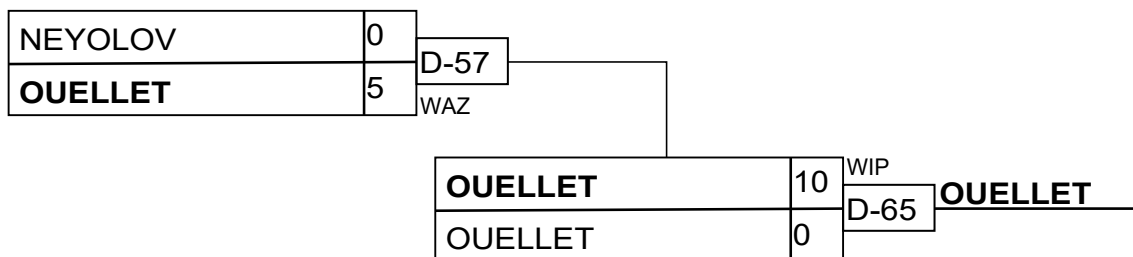
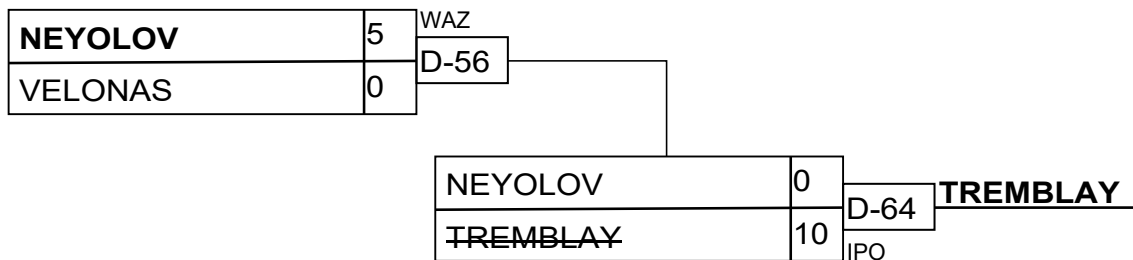

U18M -55

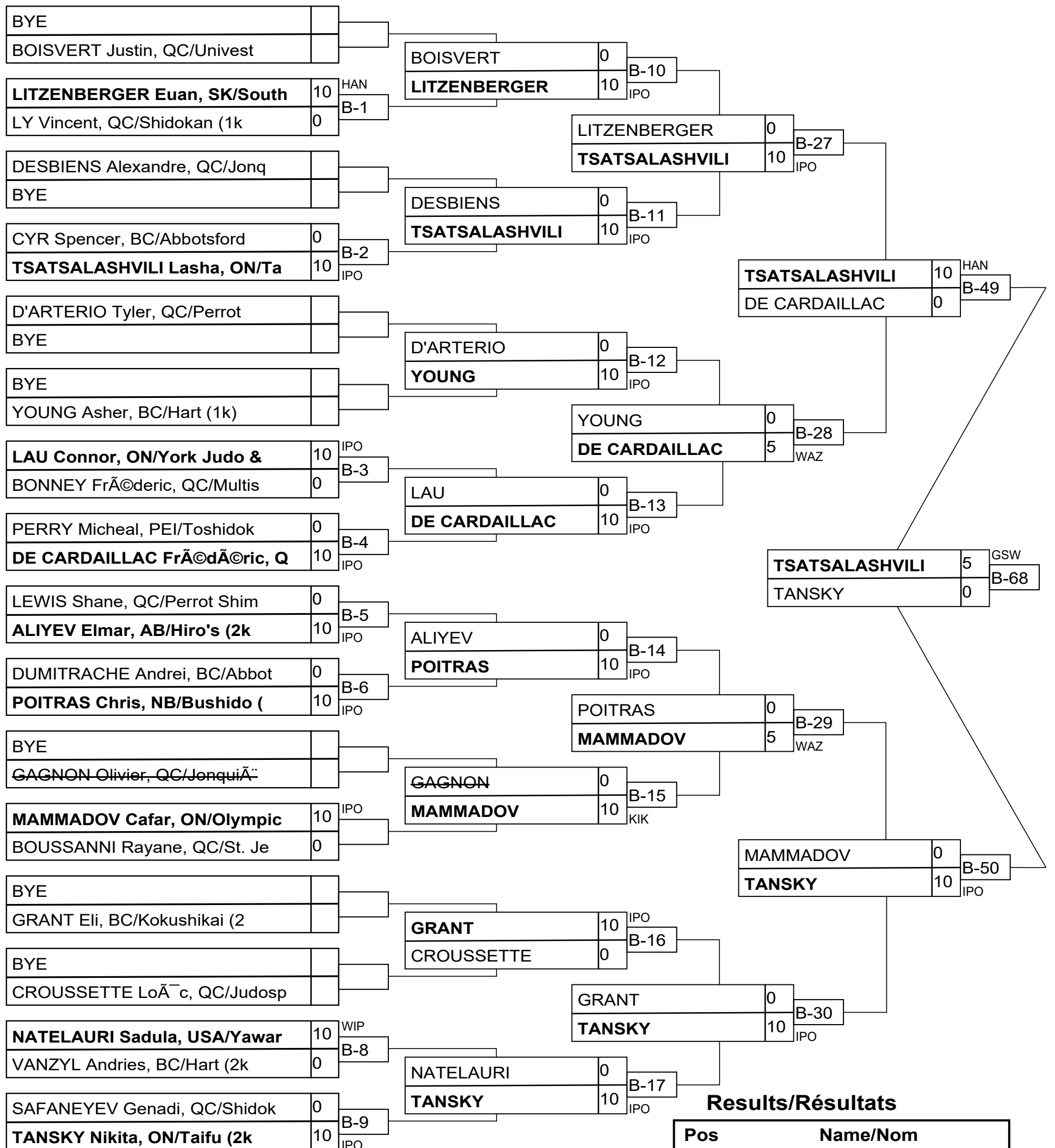

Results/Résultats

Pos	Name/Nom
1	TSATSALASHVILI Lasha, ON
2	TANSKY Nikita, ON/Taifu
3	PERRY Micheal, PEI/Toshi
3	LITZENBERGER Euan, SK/So

U18M -55

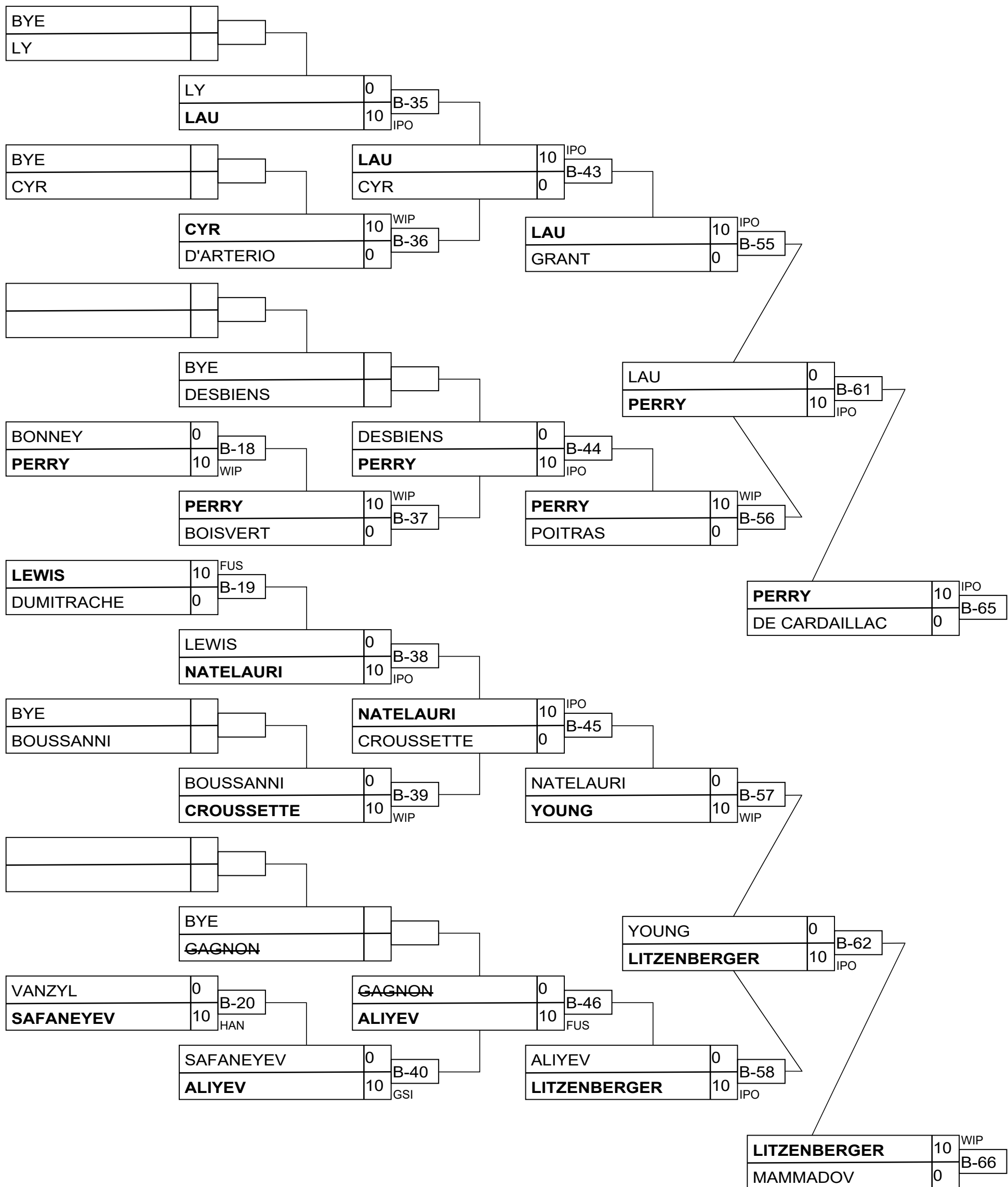

U18M -60

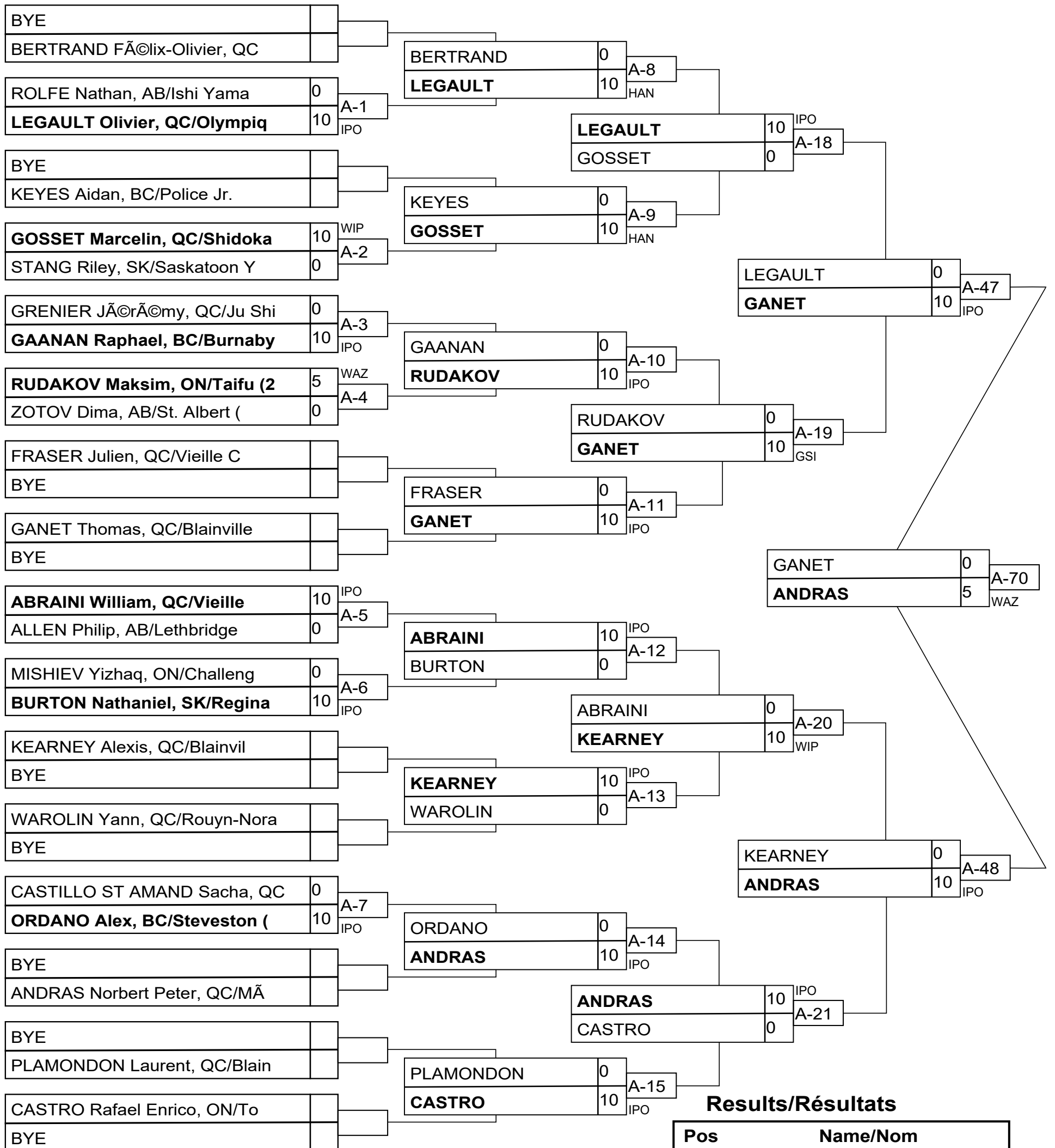

Results/Résultats

Pos	Name/Nom
1	ANDRAS Norbert Peter, QC
2	GANET Thomas, QC/Blainvi
3	GAANAN Raphael, BC/Burna
3	BURTON Nathaniel, SK/Reg

U18M -60

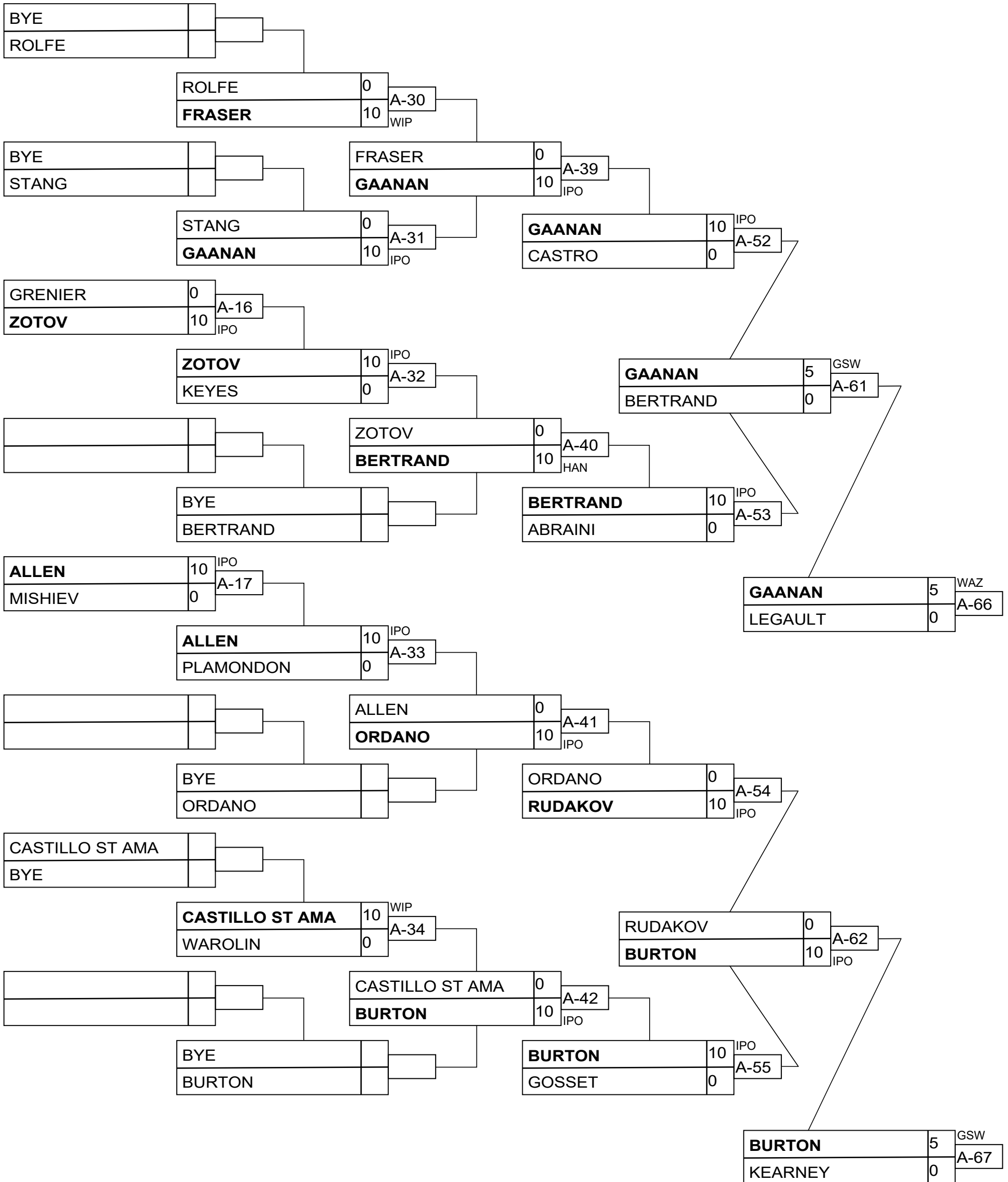

U18M -66

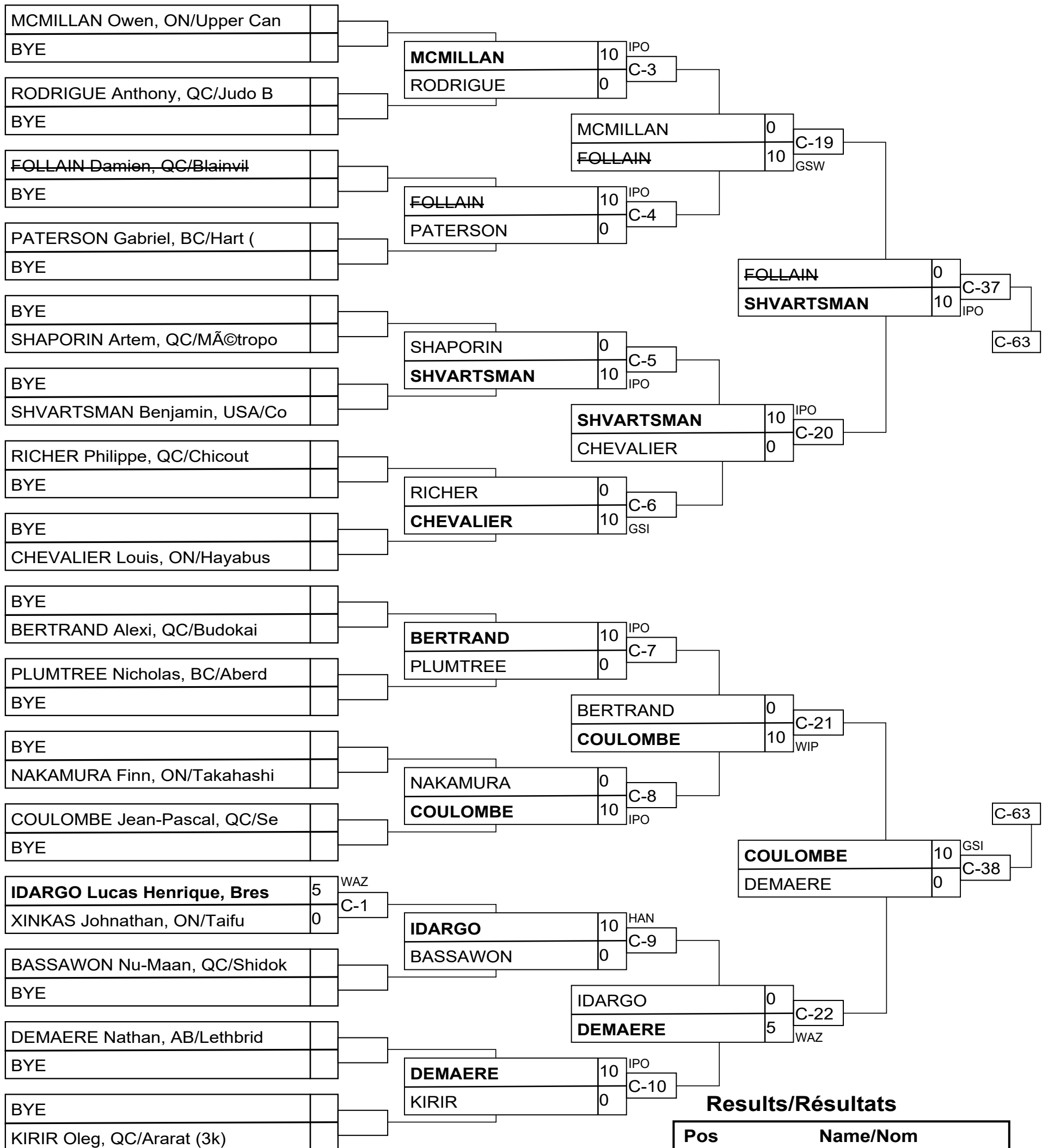

Results/Résultats

Pos	Name/Nom
1	YONEZUKA Jack, USA/Cranf
2	SHVARTSMAN Benjamin, USA
3	DESSUREAULT Victor, QC/J
3	COULOMBE Jean-Pascal, QC

U18M -66

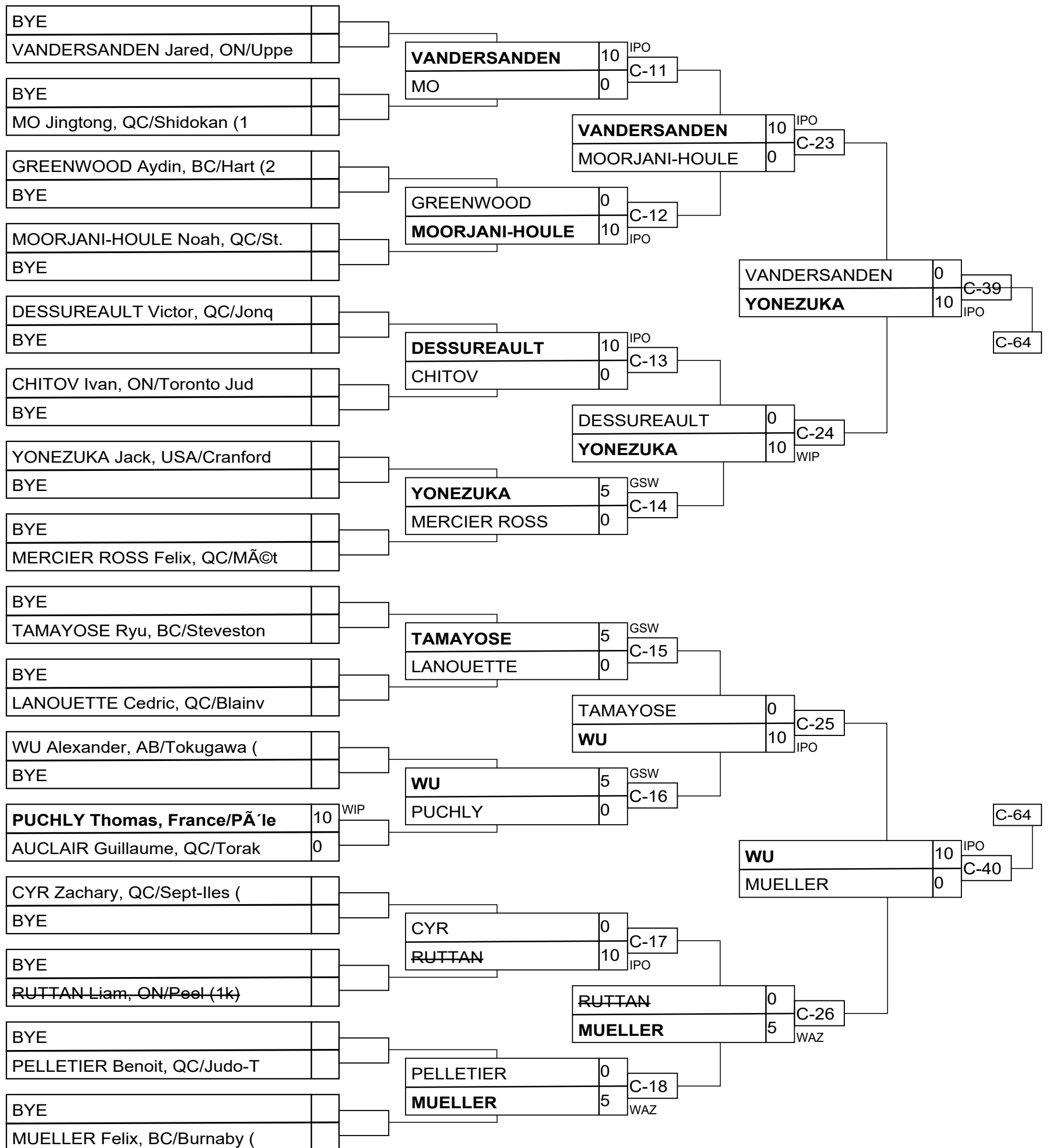

U18M -66

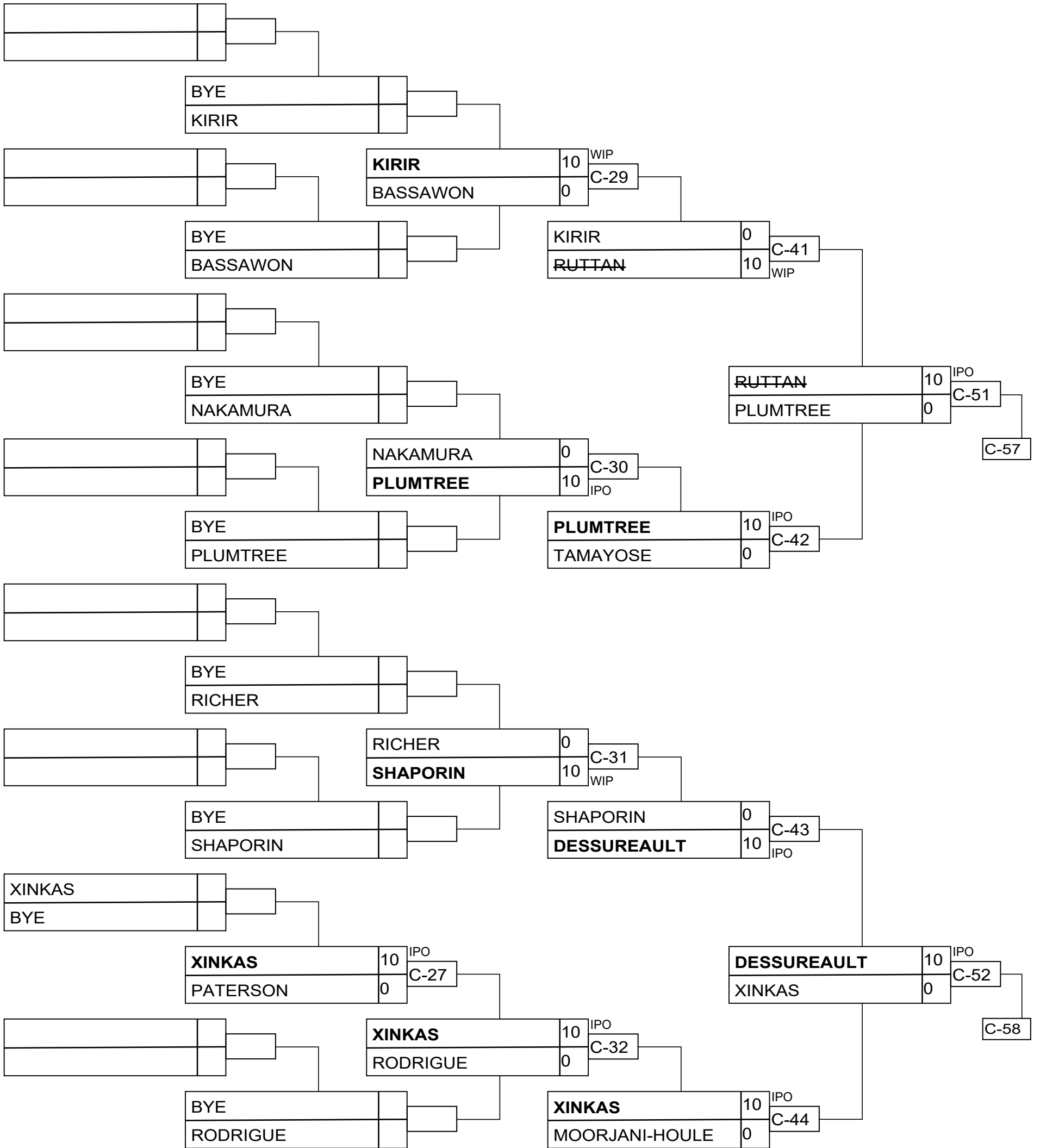

U18M -66

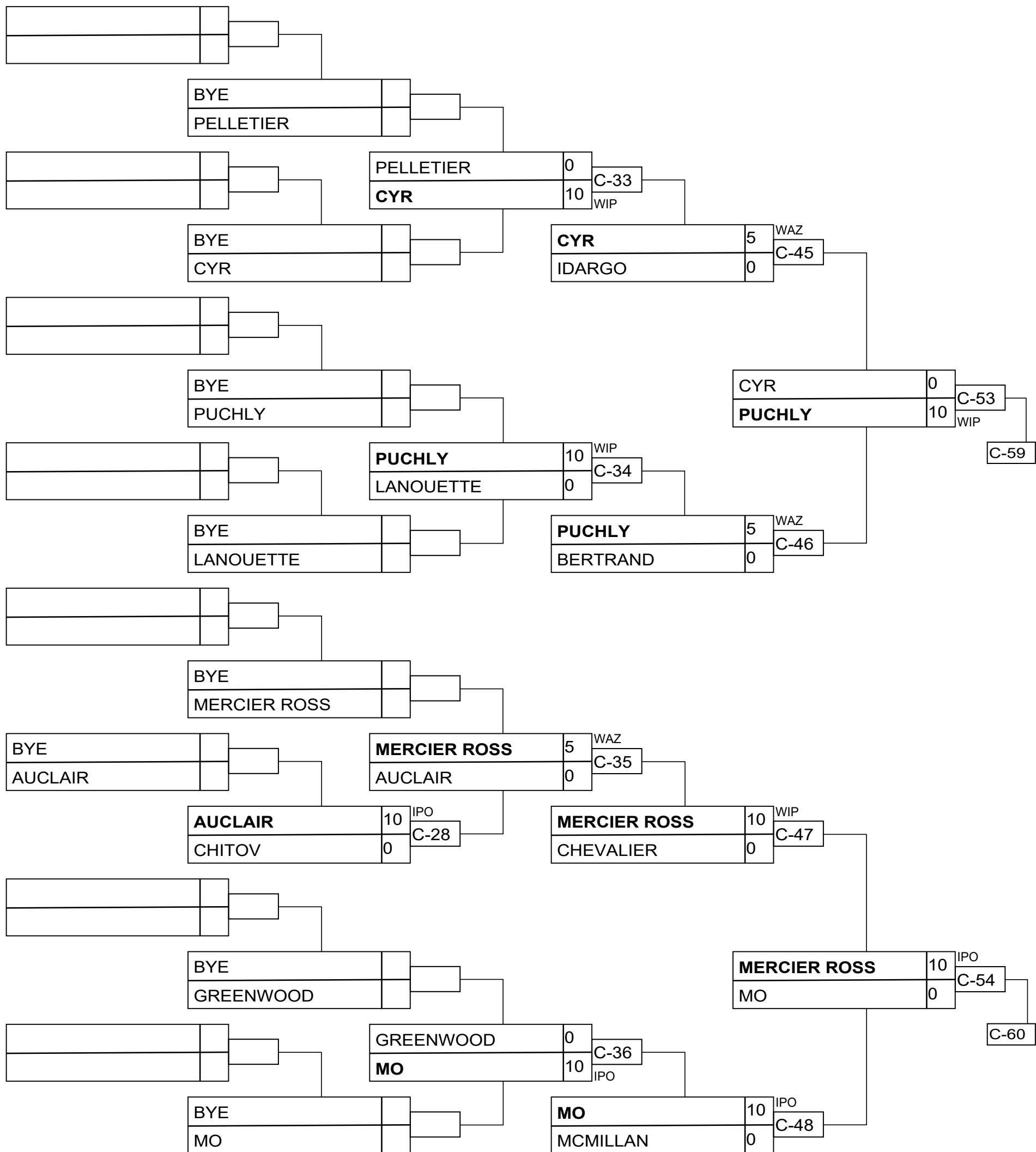

U18M -66

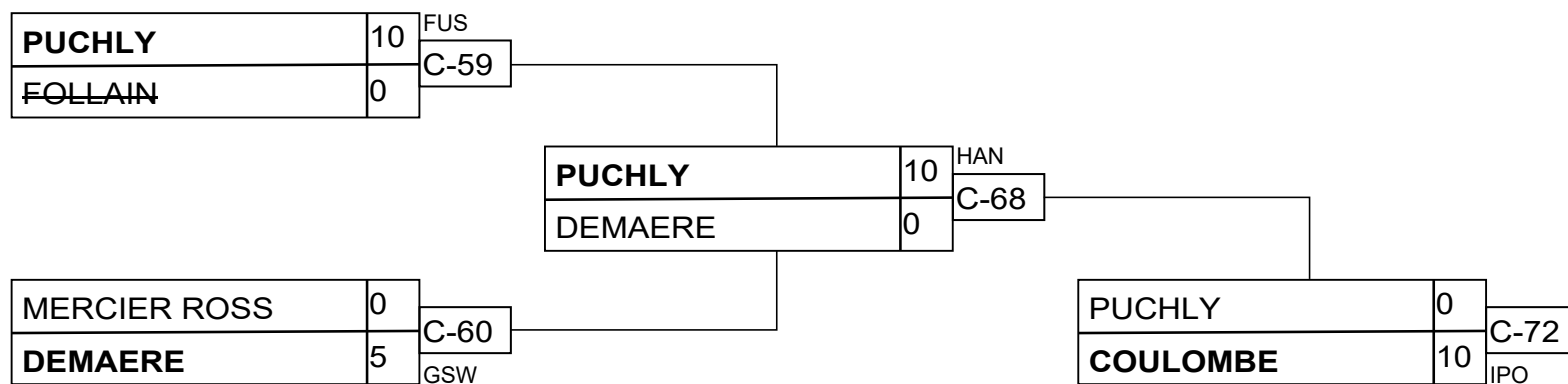
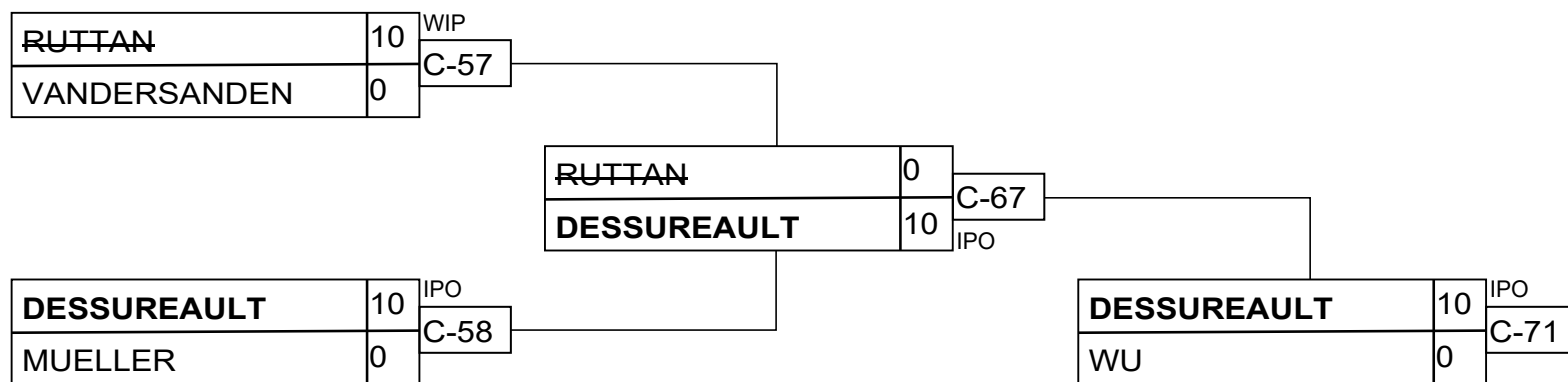
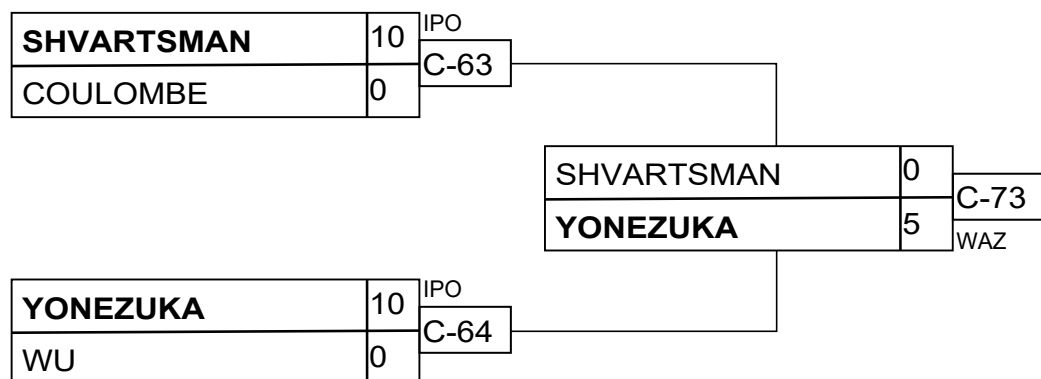

U18M -73

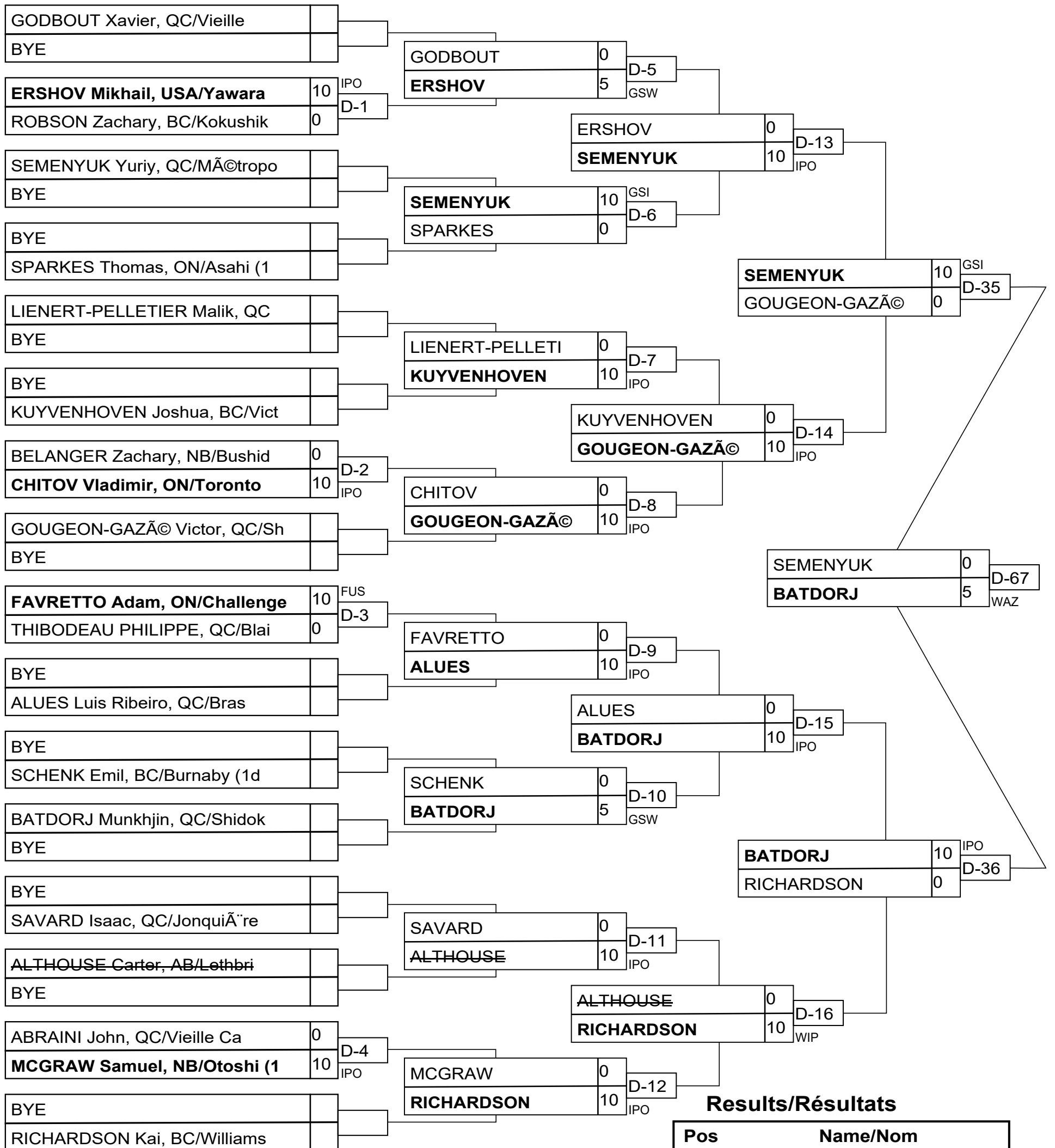

Results/Résultats

Pos	Name/Nom
1	BATDORJ Munkhjin, QC/Shi
2	SEMENYUK Yuriy, QC/MÃ@tr
3	GOUGEON-GAZÃ© Victor, QC
3	SCHENK Emil, BC/Burnaby

U18M -73

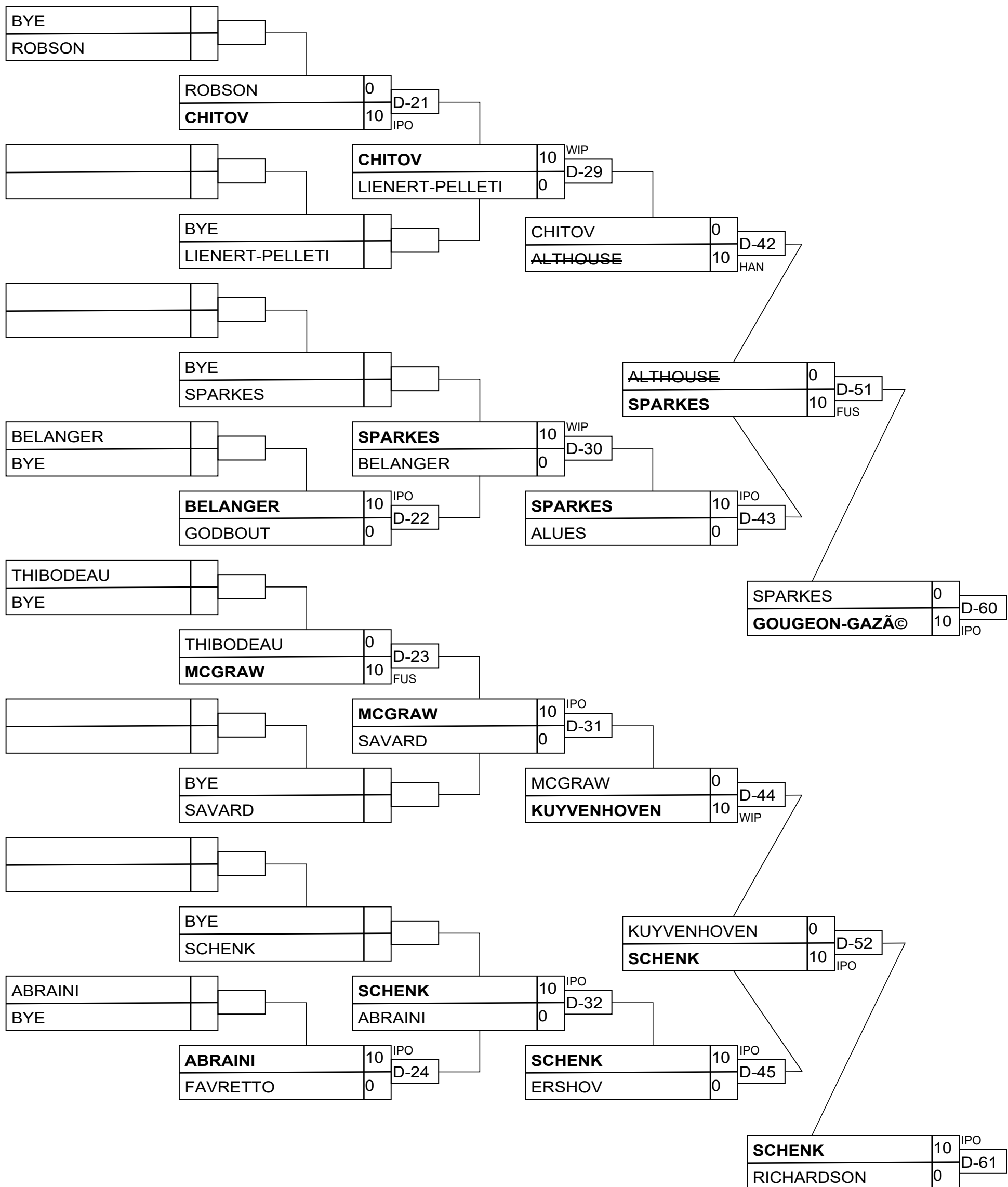

U18M -81

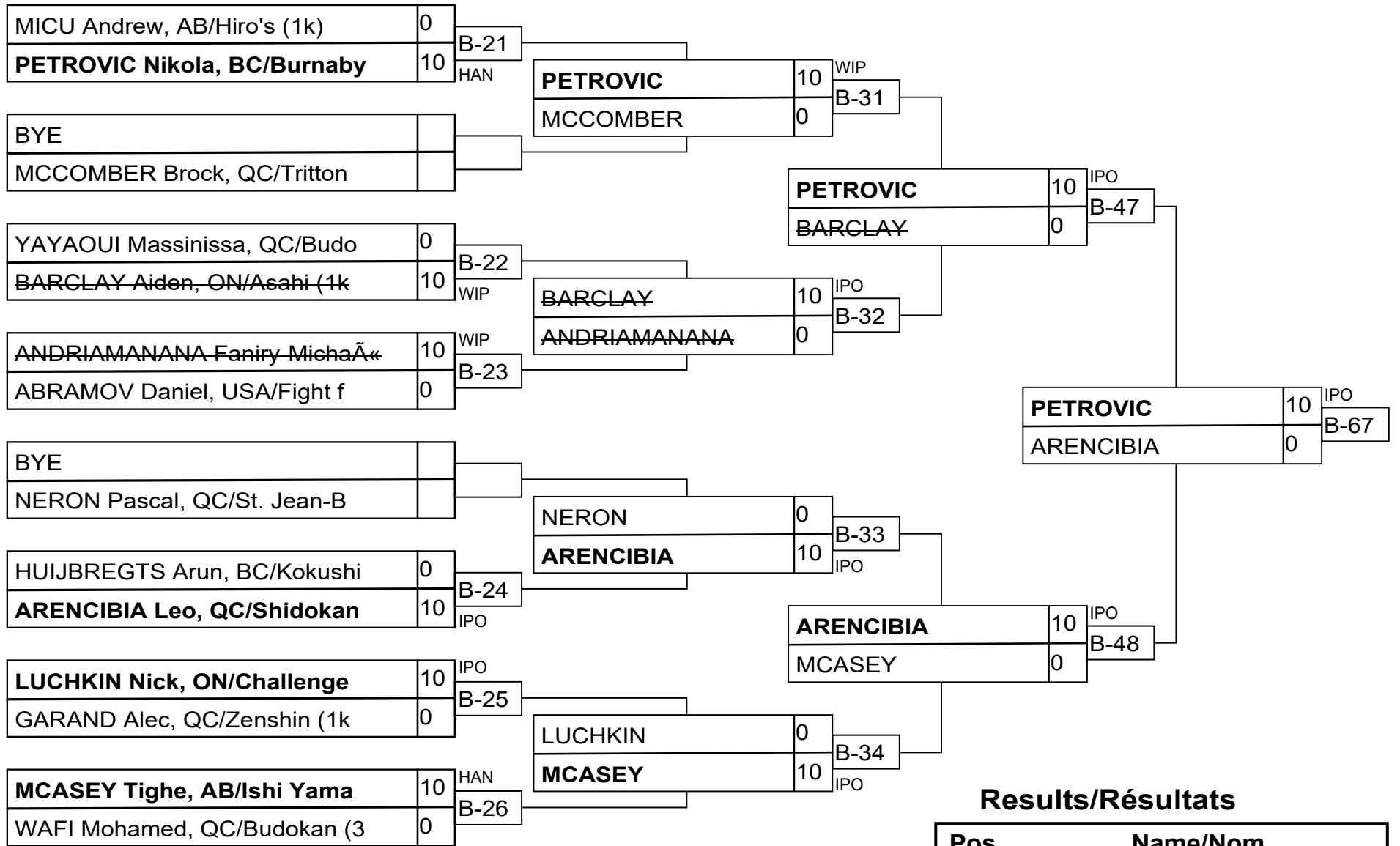

Results/Résultats

Pos	Name/Nom
1	PETROVIC Nikola, BC/Burn
2	ARENCIBIA Leo, QC/Shidok
3	ABRAMOV Daniel, USA/Figh
3	MCASEY Tighe, AB/Ishi Ya

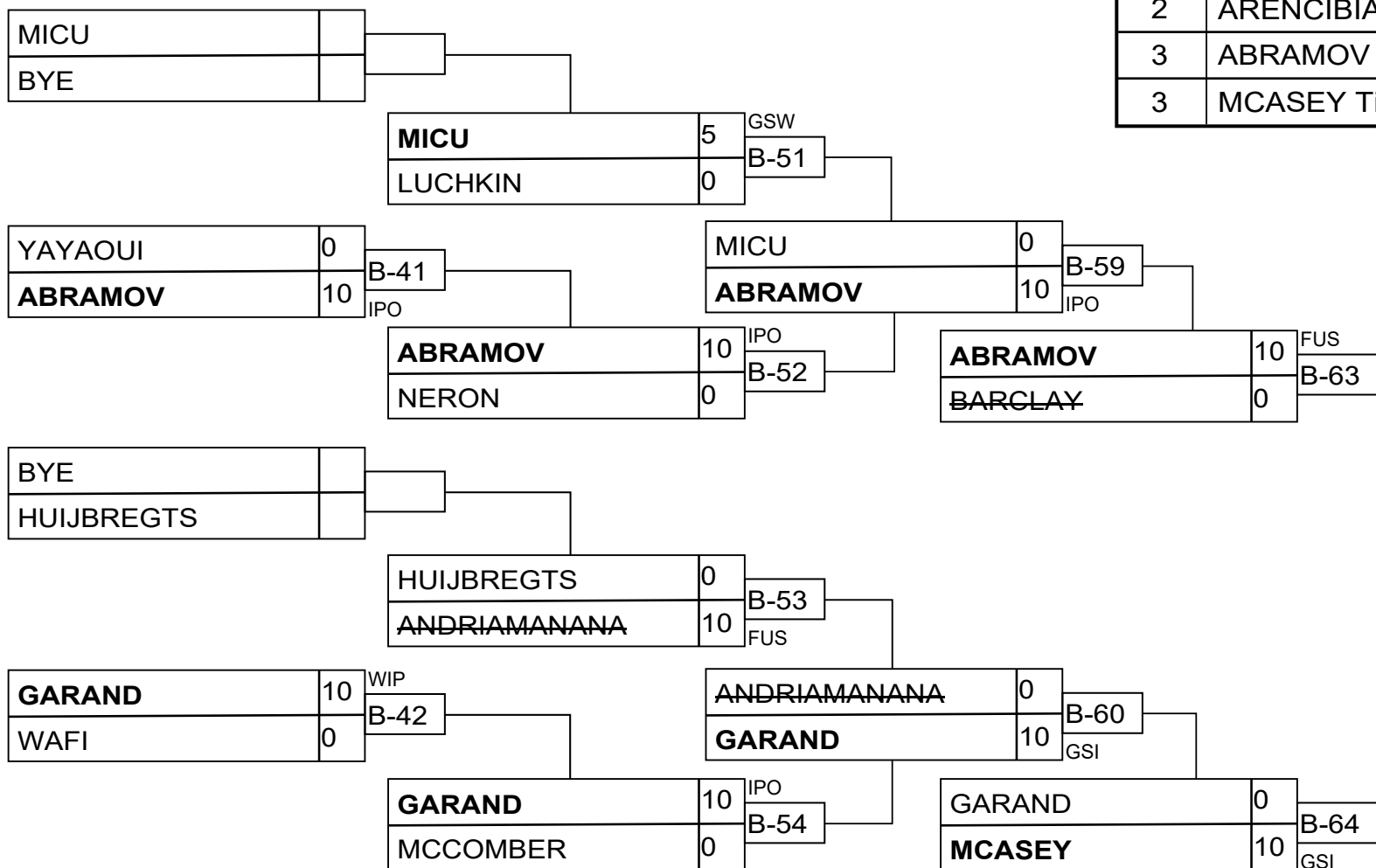

U18M -90

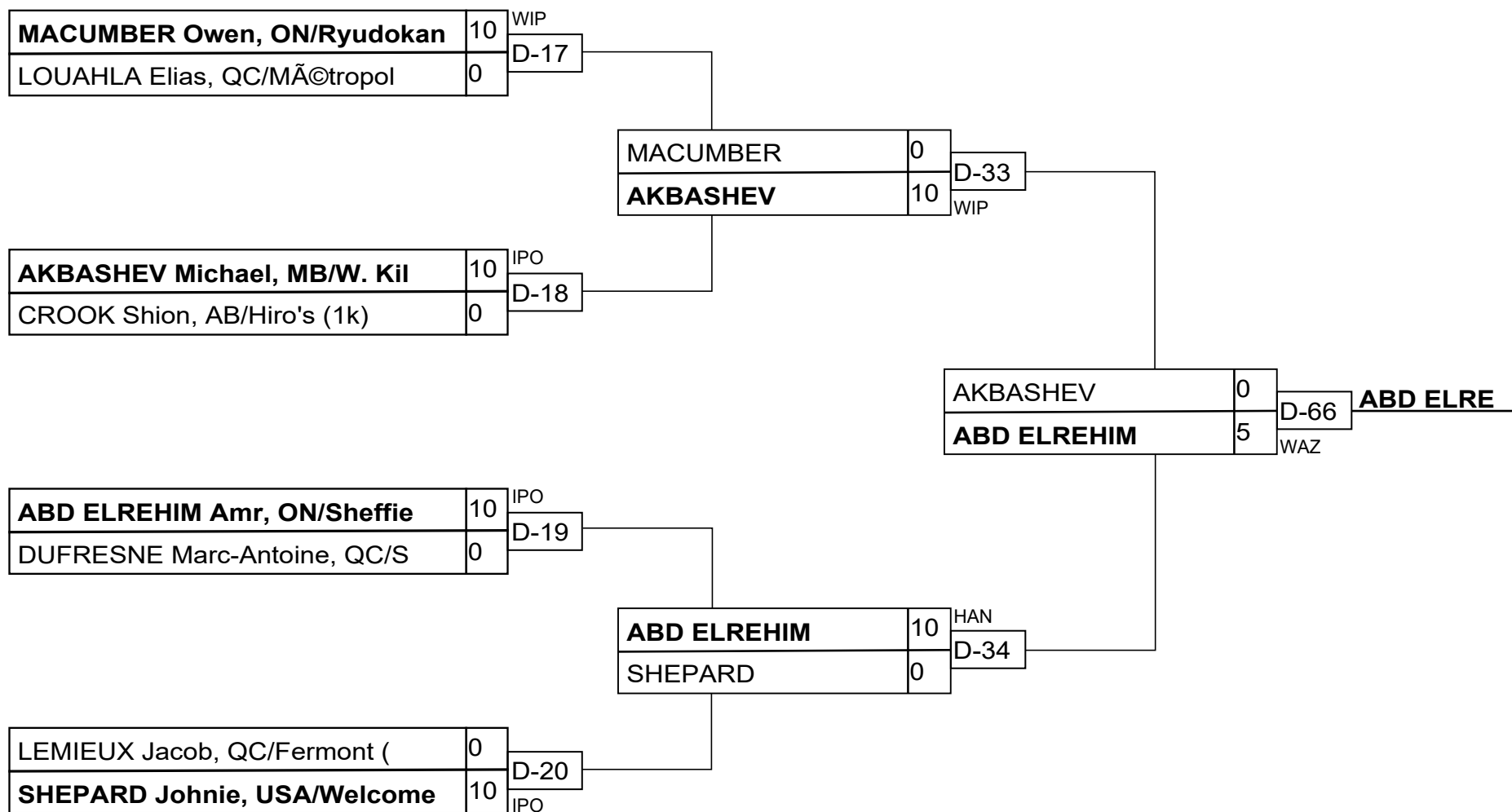

Results/Résultats

Pos	Name/Nom
1	ABD ELREHIM Amr, ON/Shef
2	AKBASHEV Michael, MB/W.
3	MACUMBER Owen, ON/Ryudok
3	SHEPARD Johnnie, USA/Welc

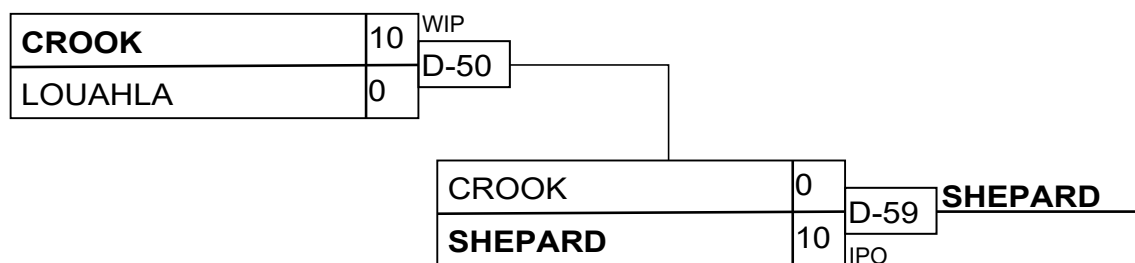
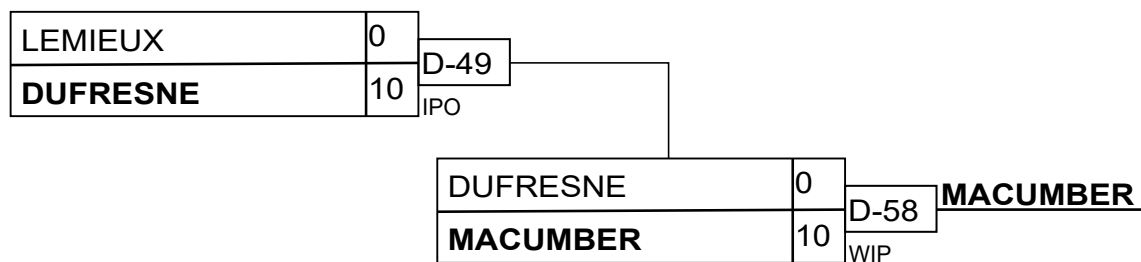

U18M +90

Competitors/Compétiteurs

#	Name/Nom	Grade	Club	1	2	3	4	5	W/G	Pts	Pos
1	MESSÃ© A BESSONG John Jr (2k	QC/Shidokan	XX	10		10	10	3	30	2
2	CROSS Nick (0,00)	1k	QC/Tritton		XX				0	0	5
3	SEMENENKO Alex (0,00)	1d	USA/Fight factory	10	10	XX	10	10	4	40	1
4	ELLIOT Nolan (0,00)	2k	NT/Kam Lake		10		XX		1	10	4
5	POPOV Joseph (0,00)	1k	ON/Toronto Judo Kai		10		10	XX	2	20	3

Matches/Matches

Match	White/Blanc			Blue/Bleu	Res/Rés	Tim/Tmp	Code
C-49	ELLIOT Nolan	4	5	POPOV Joseph	0 - 10	1:23	WIP
C-50	MESSÃ© A BESSONG John Jr	1	2	CROSS Nick	10 - 0	2:45	IPO
C-55	SEMENENKO Alex	3	4	ELLIOT Nolan	10 - 0	0:34	IPO
C-56	MESSÃ© A BESSONG John Jr	1	5	POPOV Joseph	10 - 0	2:12	IPO
C-61	CROSS Nick	2	3	SEMENENKO Alex	0 - 10	0:30	WIP
C-62	MESSÃ© A BESSONG John Jr	1	4	ELLIOT Nolan	10 - 0	2:39	IPO
C-65	SEMENENKO Alex	3	5	POPOV Joseph	10 - 0	0:09	IPO
C-66	CROSS Nick	2	4	ELLIOT Nolan	0 - 10	0:00	FUS
C-69	MESSÃ© A BESSONG John Jr	1	3	SEMENENKO Alex	0 - 10	1:28	IPO
C-70	CROSS Nick	2	5	POPOV Joseph	0 - 10	0:00	FUS

Results/Résultats

Pos	Name/Nom
1	SEMENENKO Alex, USA/Fight factory
2	MESSÃ© A BESSONG John Jr, QC/Shidokan
3	POPOV Joseph, ON/Toronto Judo Kai
4	ELLIOT Nolan, NT/Kam Lake

NeWaF Leger

Competitors/Compétiteurs

#	Name/Nom	Grade	Club	1	2	3	4	W/G	Pts	Pos
1	DA SILVA Quesia Leme (0,00)	1k	Bresil/Maua	XX	10	5	10	3	25	1
2	NASCIMENTO GOBO Suzana (0,	2k	Bresil/Maua		XX	5	10	2	15	2
3	TIE Monique (0,00)	1k	QC/Université de Montréal			XX	10	1	10	3
4	ROY Rachel (0,00)	1k	QC/Varenes				XX	0	0	4

Matches/Matches

Match	White/Blanc			Blue/Bleu	Res/Rés	Tim/Tmp	Code
G-3	DA SILVA Quesia Leme	1	2	NASCIMENTO GOBO Suzana	10 - 0	1:14	IPO
G-4	TIE Monique	3	4	ROY Rachel	10 - 0	2:04	IPO
G-25	DA SILVA Quesia Leme	1	3	TIE Monique	5 - 0	3:00	WAZ
G-26	NASCIMENTO GOBO Suzana	2	4	ROY Rachel	10 - 0	1:57	IPO
G-41	DA SILVA Quesia Leme	1	4	ROY Rachel	10 - 0	0:00	IPO
G-42	NASCIMENTO GOBO Suzana	2	3	TIE Monique	5 - 0	3:00	WAZ

Results/Résultats

Pos	Name/Nom
1	DA SILVA Quesia Leme, Bresil/Maua
2	NASCIMENTO GOBO Suzana, Bresil/Maua
3	TIE Monique, QC/Université de Montréal

NeWaF Lourd

Competitors/Compétiteurs

#	Name/Nom	Grade	Club	1	2	3	4	W/G	Pts	Pos
1	MCALPINE Amanda (0,00)	1d	ON/Kohbukan-Sisu	XX	10			1	10	3
2	KASURAK Ashley (0,00)	1k	ON/Sheffield		XX			0	0	4
3	LISBOA Mayara (0,00)	1d	Bresil/Maua	5	5	XX		2	10	2
4	HANKS Megan (0,00)	2d	BC/Aberdeen	10	10	10	XX	3	30	1

Matches/Matches

Match	White/Blanc			Blue/Bleu	Res/Rés	Tim/Tmp	Code
G-12	MCALPINE Amanda	1	2	KASURAK Ashley	10 - 0	0:57	IPO
G-13	LISBOA Mayara	3	4	HANKS Megan	0 - 10	1:15	IPO
G-28	MCALPINE Amanda	1	3	LISBOA Mayara	0 - 5	3:00	WAZ
G-29	KASURAK Ashley	2	4	HANKS Megan	0 - 10	0:34	IPO
G-44	MCALPINE Amanda	1	4	HANKS Megan	0 - 10	2:23	IPO
G-45	KASURAK Ashley	2	3	LISBOA Mayara	0 - 5	3:00	WAZ

Results/Résultats

Pos	Name/Nom
1	HANKS Megan, BC/Aberdeen
2	LISBOA Mayara, Bresil/Maua
3	MCALPINE Amanda, ON/Kohbukan-Sisu

NeWaF Moyen

Competitors/Compétiteurs

#	Name/Nom	Grade	Club	1	2	1	2	1	2	W/G	Pts	Pos
1	JANSSEN Danique (0,00)	2d	ON/JC Hercules	XX	10	XX	10	XX		2	20	1
2	DO AMARAL Jéssica (0,00)	1d	Bresil/Maua		XX		XX		XX	0	0	2

Matches/Matches

Match	White/Blanc			Blue/Bleu	Res/Rés	Tim/Tmp	Code
G-11	JANSSEN Danique	1	2	DO AMARAL Jéssica	10 - 0	3:08	HAN
G-27	DO AMARAL Jéssica	2	1	JANSSEN Danique	0 - 10	2:50	IPO
G-43	JANSSEN Danique	1	2	DO AMARAL Jéssica			

Results/Résultats

Pos	Name/Nom
1	JANSSEN Danique, ON/JC Hercules

NeWaM Leger

Competitors/Compétiteurs

#	Name/Nom	Grade	Club	1	2	3	4	W/G	Pts	Pos
1	XINKAS Johnathan (0,00)	2k+	ON/Taifu	XX						
2	RUBTSOV David (0,00)	3k	ON/Taifu		XX					
3	KARN Justin (0,00)	2d	QC/Shidokan	10	10	XX	10	3	30	
4	SALIM Moh'd Nour (0,00)	1d	ON/Kohbukan-Sisu	10	10		XX	2	20	

Matches/Matches

Match	White/Blanc			Blue/Bleu	Res/Rés	Tim/Tmp	Code
G-14	XINKAS Johnathan	1	2	RUBTSOV David			
G-15	KARN Justin	3	4	SALIM Moh'd Nour	10 - 0	2:33	IPO
G-30	XINKAS Johnathan	1	3	KARN Justin	0 - 10	0:00	FUS
G-31	RUBTSOV David	2	4	SALIM Moh'd Nour	0 - 10	0:00	FUS
G-46	XINKAS Johnathan	1	4	SALIM Moh'd Nour	0 - 10	0:00	FUS
G-47	RUBTSOV David	2	3	KARN Justin	0 - 10	0:00	FUS

Results/Résultats

Pos	Name/Nom

NeWaM Moyen1

Competitors/Compétiteurs

#	Name/Nom	Grade	Club	1	2	3	4	W/G	Pts	Pos
1	CASSISTA Ludovik (0,00)	1d	NB/Otoshi	XX	5	5	10	3	20	1
2	KRISTOFFERSEN Samuel (0,00)	3d	NB/Fredericton		XX		10	1	10	3
3	DION Philip (0,00)	2d	QC/Boucherville		5	XX	10	2	15	2
4	TOURNIER Riwan (0,00)	1d	QC/Vieille Capitale				XX	0	0	4

Matches/Matches

Match	White/Blanc			Blue/Bleu	Res/Rés	Tim/Tmp	Code
G-7	CASSISTA Ludovik	1	2	KRISTOFFERSEN Samuel	5 - 0	3:17	GSW
G-8	DION Philip	3	4	TOURNIER Riwan	10 - 0	0:29	IPO
G-21	CASSISTA Ludovik	1	3	DION Philip	5 - 0	3:00	WAZ
G-22	KRISTOFFERSEN Samuel	2	4	TOURNIER Riwan	10 - 0	0:46	IPO
G-37	CASSISTA Ludovik	1	4	TOURNIER Riwan	10 - 0	0:52	IPO
G-38	KRISTOFFERSEN Samuel	2	3	DION Philip	0 - 5	3:00	WAZ

Results/Résultats

Pos	Name/Nom
1	CASSISTA Ludovik, NB/Otoshi
2	DION Philip, QC/Boucherville
3	KRISTOFFERSEN Samuel, NB/Fredericton

NeWaM Moyen2

Competitors/Compétiteurs

#	Name/Nom	Grade	Club	1	2	3	4	5	W/G	Pts	Pos
1	DUBE Christopher (0,00)	1k	ON/R.A.	XX	10				1	10	4
2	DA SILVA Marco Antonio (0,	1k	Bresil/Maua		XX				0	0	5
3	HURST Matt (0,00)	1d	NB/Dragons Judo Club	10	10	XX	10	10	4	40	1
4	MAROC Gregory (0,00)	1d	QC/Jikan	10	10		XX	10	3	30	2
5	MORGAN Mckenzie (0,00)	1d	AB/Airdrie	10	10			XX	2	20	3

Matches/Matches

Match	White/Blanc			Blue/Bleu	Res/Rés	Tim/Tmp	Code
G-1	MAROC Gregory	4	5	MORGAN Mckenzie	10 - 0	0:36	IPO
G-2	DUBE Christopher	1	2	DA SILVA Marco Antonio	10 - 0	2:09	IPO
G-5	HURST Matt	3	4	MAROC Gregory	10 - 0	0:12	IPO
G-6	DUBE Christopher	1	5	MORGAN Mckenzie	0 - 10	2:04	IPO
G-9	DA SILVA Marco Antonio	2	3	HURST Matt	0 - 10	0:19	IPO
G-10	DUBE Christopher	1	4	MAROC Gregory	0 - 10	2:56	IPO
G-23	HURST Matt	3	5	MORGAN Mckenzie	10 - 0	0:21	IPO
G-24	DA SILVA Marco Antonio	2	4	MAROC Gregory	0 - 10	1:14	IPO
G-39	DUBE Christopher	1	3	HURST Matt	0 - 10	0:22	IPO
G-40	DA SILVA Marco Antonio	2	5	MORGAN Mckenzie	0 - 10	1:58	HAN

Results/Résultats

Pos	Name/Nom
1	HURST Matt, NB/Dragons Judo Club
2	MAROC Gregory, QC/Jikan
3	MORGAN Mckenzie, AB/Airdrie
4	DUBE Christopher, ON/R.A.

NeWasa VetM Moyen

Competitors/Compétiteurs

#	Name/Nom	Grade	Club	1	2	3	4	W/G	Pts	Pos
1	MACDONALD Scott (0,00)	1k	ON/Jackpine	XX		10		1	10	3
2	DICKINSON Wayne (0,00)	5d	USA/Celtic	10	XX	10		2	20	2
3	NGUYEN Hong (0,00)	1k	QC/Jikan			XX		0	0	4
4	BORAY Amro (0,00)	3d	NB/Otoshi	10	10	10	XX	3	30	1

Matches/Matches

Match	White/Blanc			Blue/Bleu	Res/Rés	Tim/Tmp	Code
G-16	MACDONALD Scott	1	2	DICKINSON Wayne	0 - 10	2:07	IPO
G-17	NGUYEN Hong	3	4	BORAY Amro	0 - 10	0:00	IPO
G-32	MACDONALD Scott	1	3	NGUYEN Hong	10 - 0	0:00	IPO
G-33	DICKINSON Wayne	2	4	BORAY Amro	0 - 10	0:36	IPO
G-48	MACDONALD Scott	1	4	BORAY Amro	0 - 10	0:28	IPO
G-49	DICKINSON Wayne	2	3	NGUYEN Hong	10 - 0	0:00	IPO

Results/Résultats

Pos	Name/Nom
1	BORAY Amro, NB/Otoshi
2	DICKINSON Wayne, USA/Celtic
3	MACDONALD Scott, ON/Jackpine

NeWasaM Lourd

Competitors/Compétiteurs

#	Name/Nom	Grade	Club	1	2	3	4	W/G	Pts	Pos
1	BOARO Kristopher (0,00)	1d	ON/North Bay	XX			5	1	5	3
2	ALLEN Jeff (0,00)	1d	ON/Huntsville	5	XX		10	2	15	2
3	DOS SANTOS Rogerio (0,00)	1d	Bresil/Maua	10	10	XX	10	3	30	1
4	ST LOUIS Terry (0,00)	1k	ON/Sho Jin				XX	0	0	4

Matches/Matches

Match	White/Blanc			Blue/Bleu	Res/Rés	Tim/Tmp	Code
G-18	BOARO Kristopher	1	2	ALLEN Jeff	0 - 5	3:00	WAZ
G-19	DOS SANTOS Rogerio	3	4	ST LOUIS Terry	10 - 0	0:32	IPO
G-34	BOARO Kristopher	1	3	DOS SANTOS Rogerio	0 - 10	1:51	IPO
G-35	ALLEN Jeff	2	4	ST LOUIS Terry	10 - 0	1:47	IPO
G-50	BOARO Kristopher	1	4	ST LOUIS Terry	5 - 0	3:00	WAZ
G-51	ALLEN Jeff	2	3	DOS SANTOS Rogerio	0 - 10	1:37	IPO

Results/Résultats

Pos	Name/Nom
1	DOS SANTOS Rogerio, Bresil/Maua
2	ALLEN Jeff, ON/Huntsville
3	BOARO Kristopher, ON/North Bay

NeWaza VetM Lourd

Competitors/Compétiteurs

#	Name/Nom	Grade	Club	1	2	1	2	1	2	W/G	Pts	Pos
1	JOHNSON Kurtis (0,00)	1d	AB/Tokugawa	XX	5	XX	10	XX		2	15	1
2	LAVOIE Vincent (0,00)	2d	QC/Multisports		XX		XX		XX	0	0	2

Matches/Matches

Match	White/Blanc			Blue/Bleu	Res/Rés	Tim/Tmp	Code
G-20	JOHNSON Kurtis	1	2	LAVOIE Vincent	5 - 0	3:00	WAZ
G-36	LAVOIE Vincent	2	1	JOHNSON Kurtis	0 - 10	6:14	HAN
G-52	JOHNSON Kurtis	1	2	LAVOIE Vincent			

Results/Résultats

Pos	Name/Nom
1	JOHNSON Kurtis, AB/Tokugawa

U18F -44

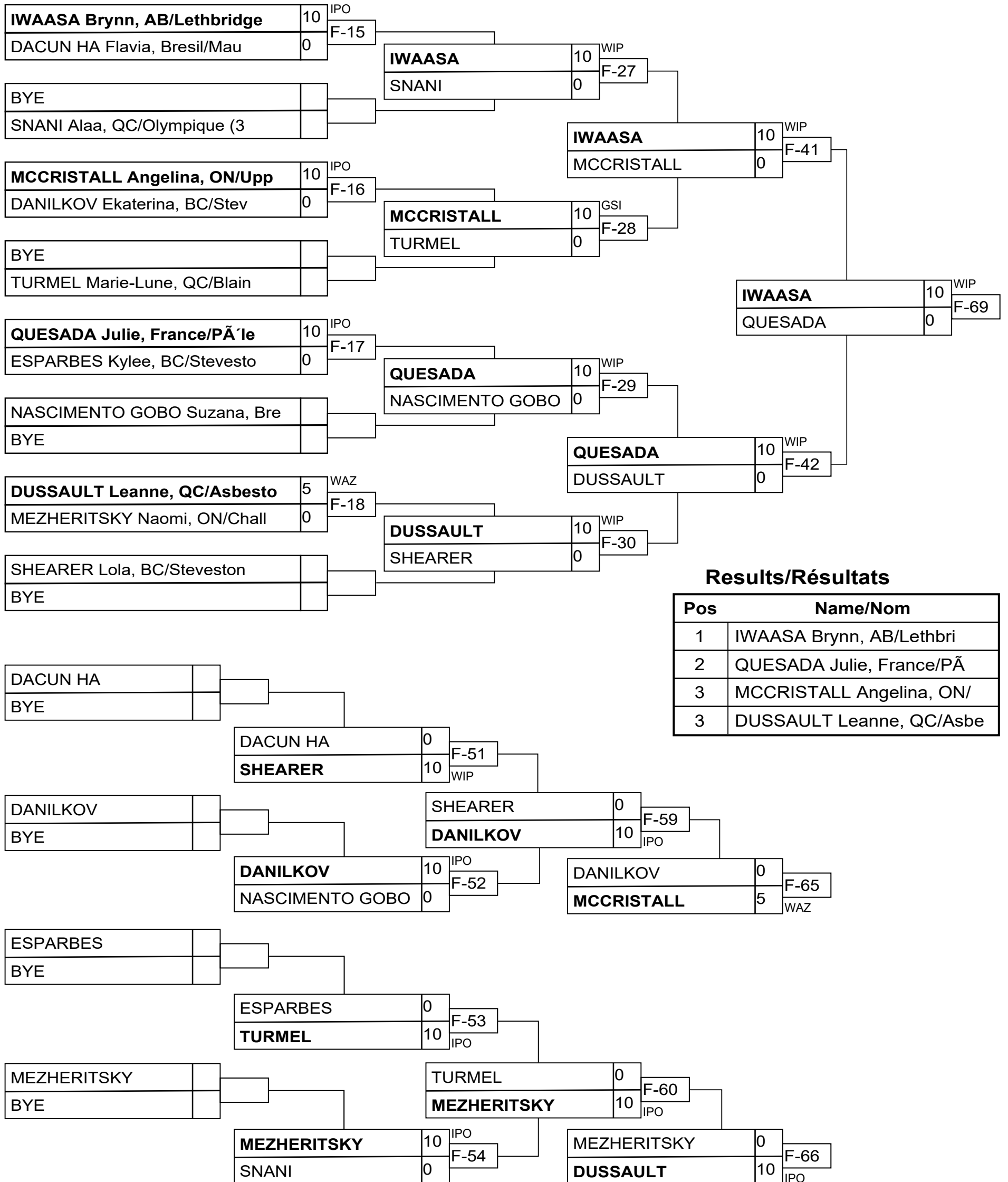

Results/Résultats

Pos	Name/Nom
1	IWAASA Brynn, AB/Lethbri
2	QUESADA Julie, France/PÃ'
3	MCCRISTALL Angelina, ON/
3	DUSSAULT Leanne, QC/Asbe

U18F -48

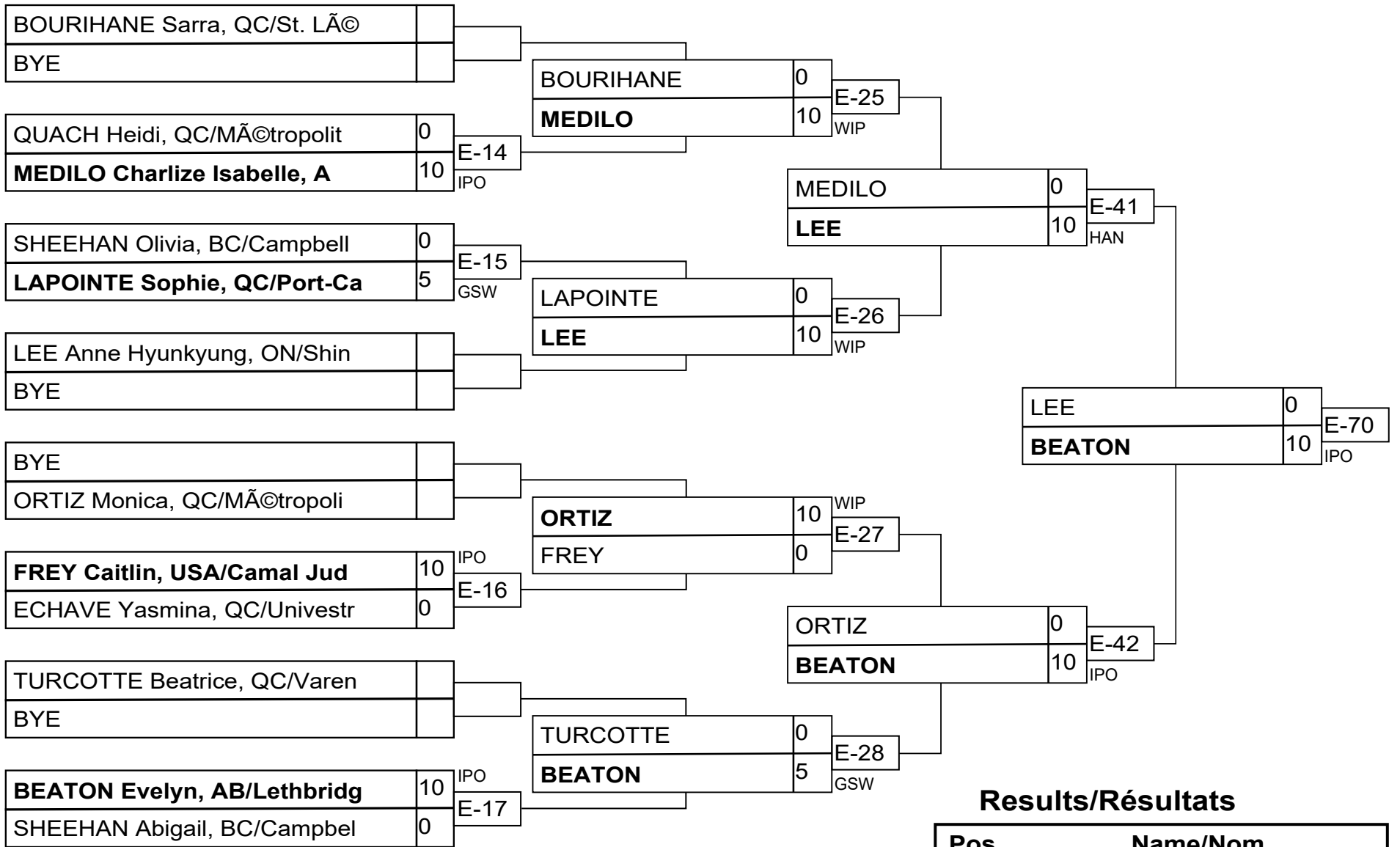

Results/Résultats

Pos	Name/Nom
1	BEATON Evelyn, AB/Lethbr
2	LEE Anne Hyunkyung, ON/S
3	MEDILO Charlize Isabelle
3	BOURIHANE Sarra, QC/St.

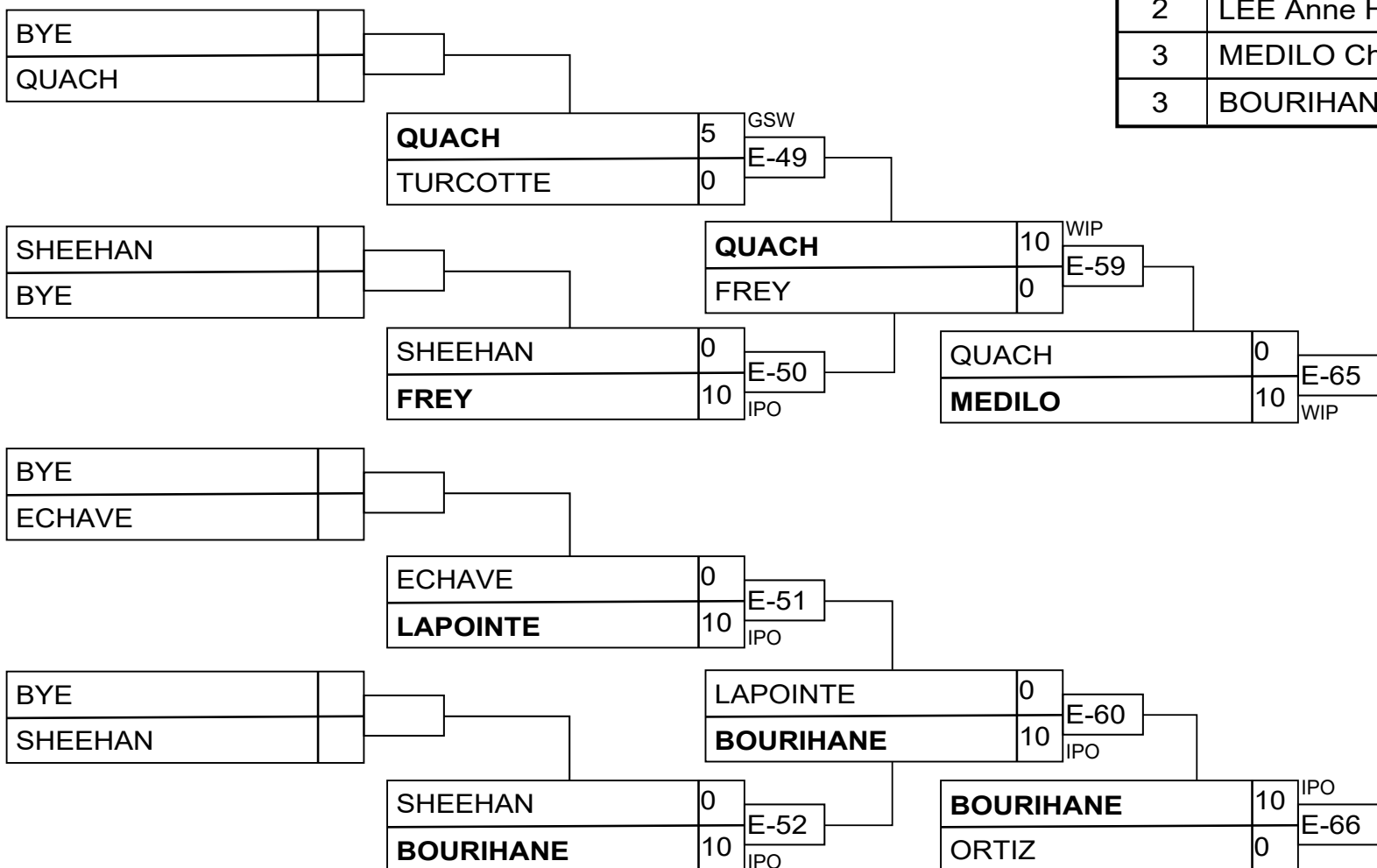

U18F -57

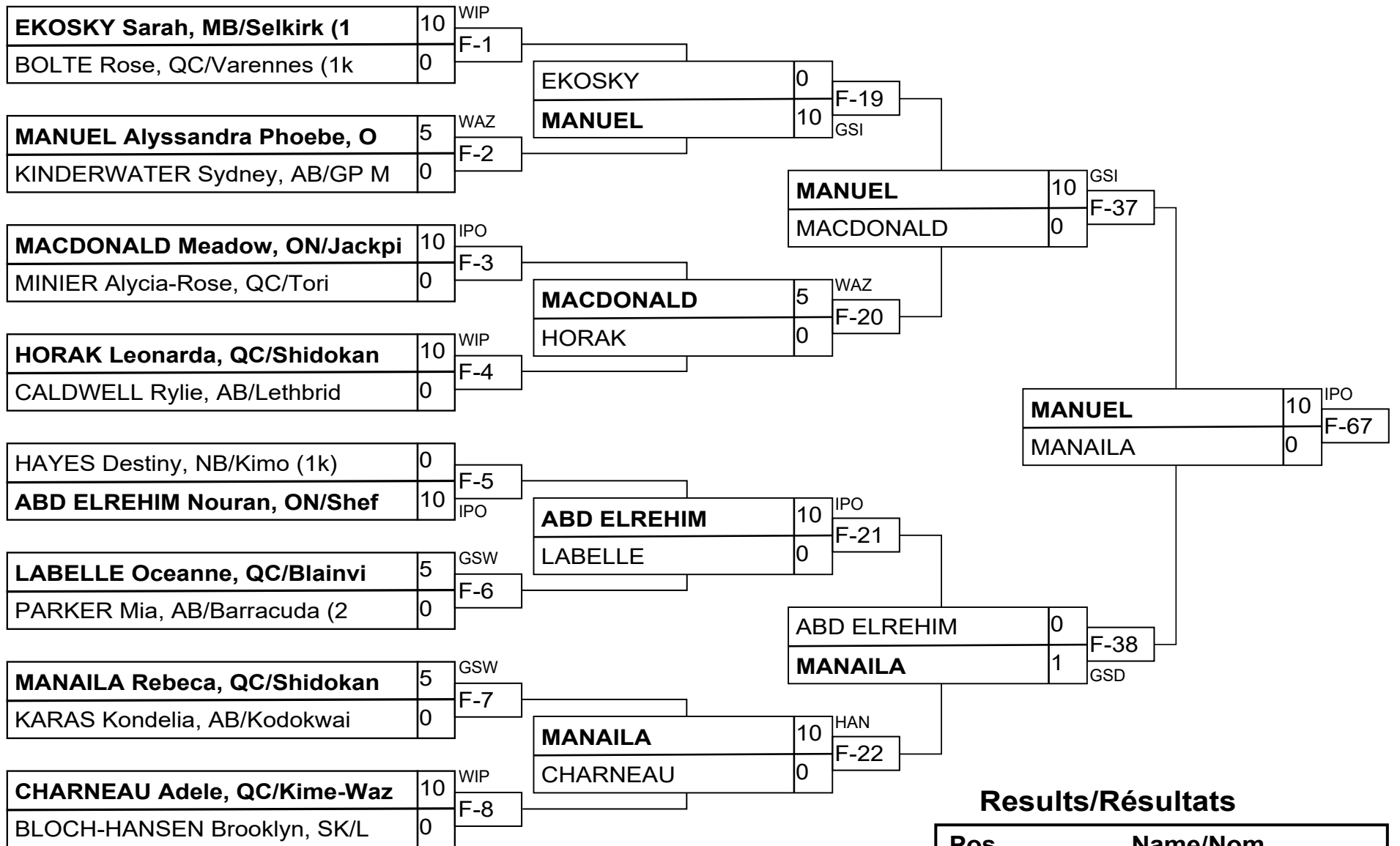

Results/Résultats

Pos	Name/Nom
1	MANUEL Alyssandra Phoebe
2	MANAILA Rebeca, QC/Shido
3	MACDONALD Meadow, ON/Jac
3	ABD ELREHIM Nouran, ON/S

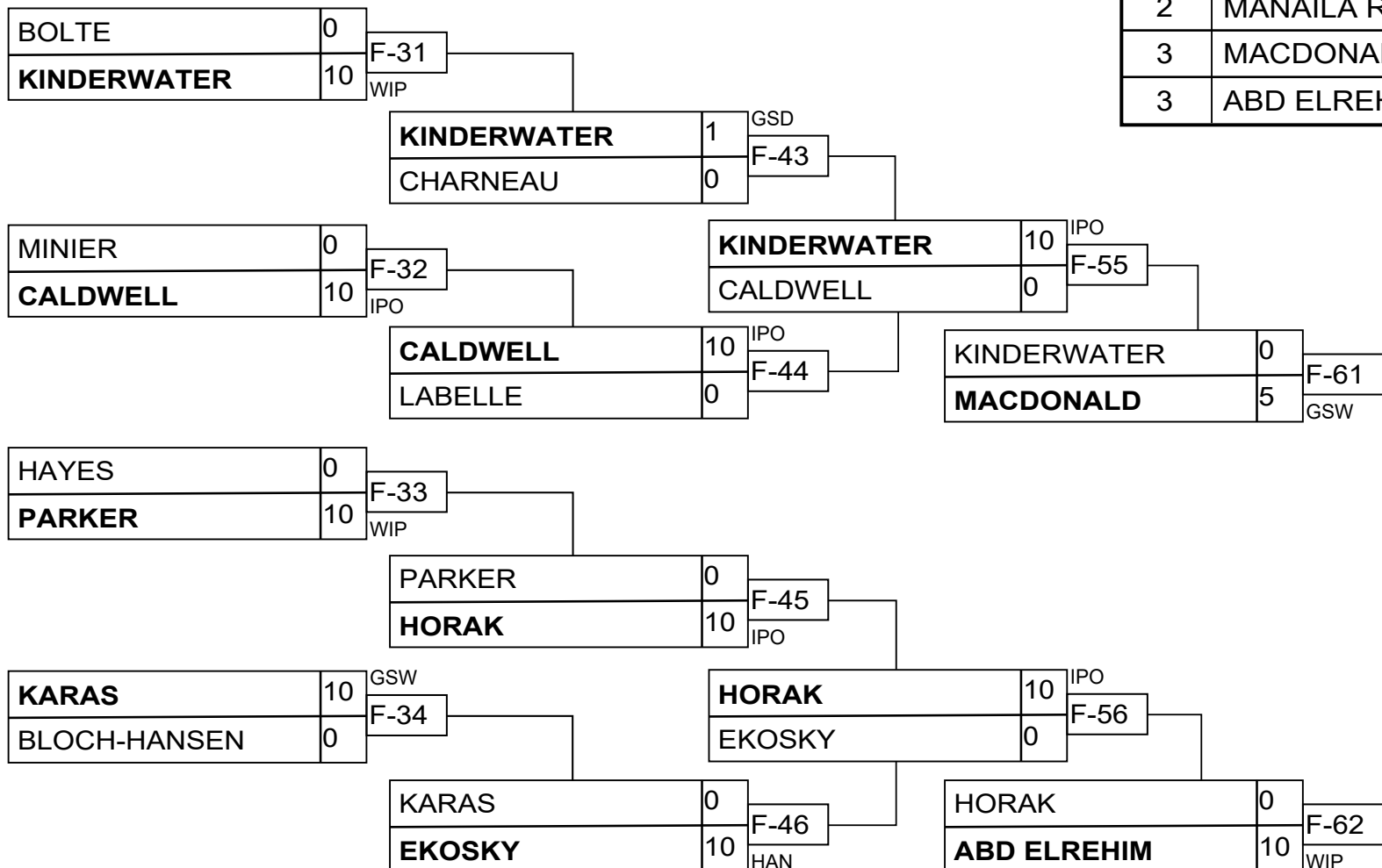

U18F -63

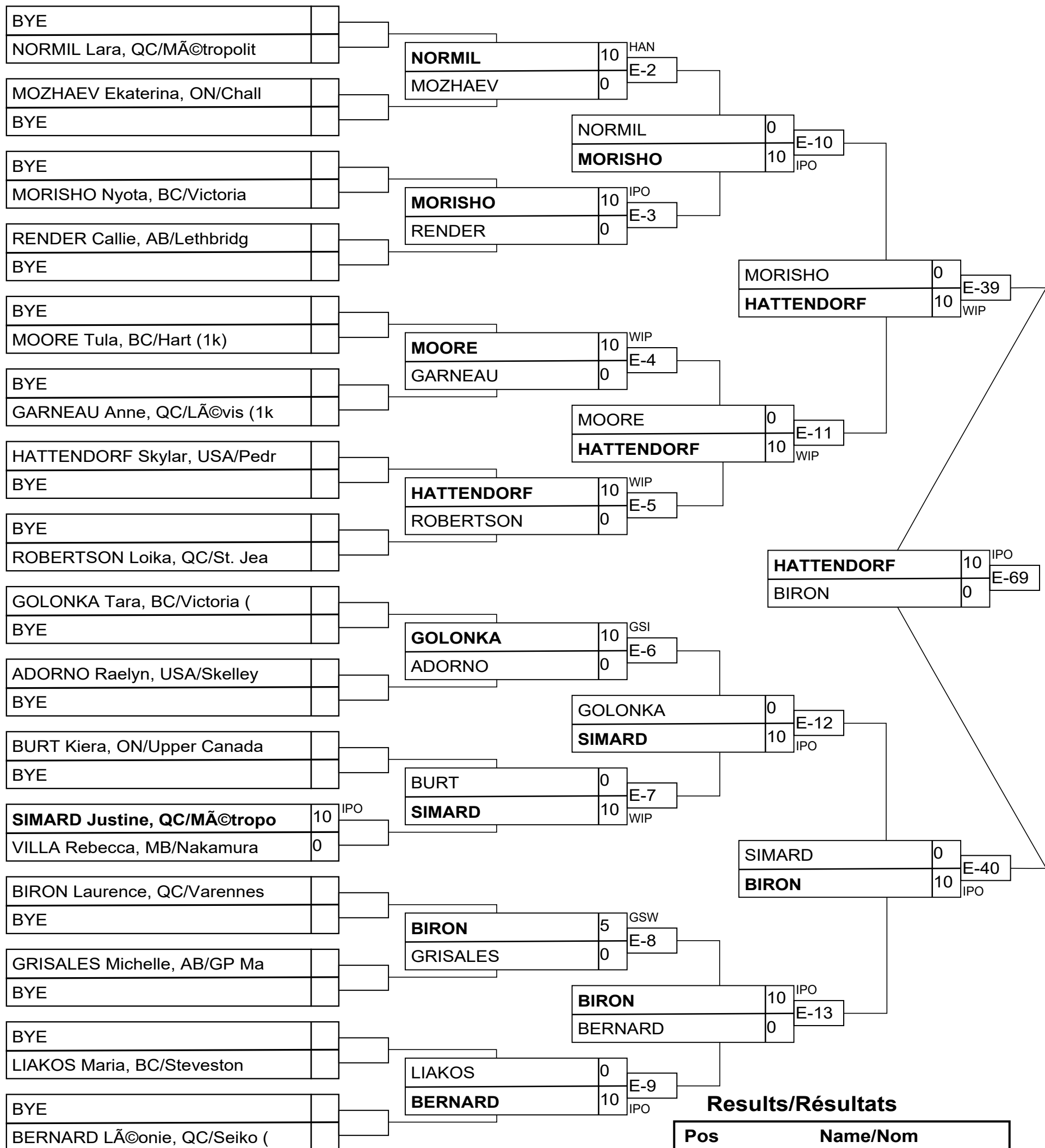

Results/Résultats

Pos	Name/Nom
1	HATTENDORF Skylar, USA/P
2	BIRON Laurence, QC/Varen
3	MORISHO Nyota, BC/Victor
3	SIMARD Justine, QC/MÃ@tr

U18F -63

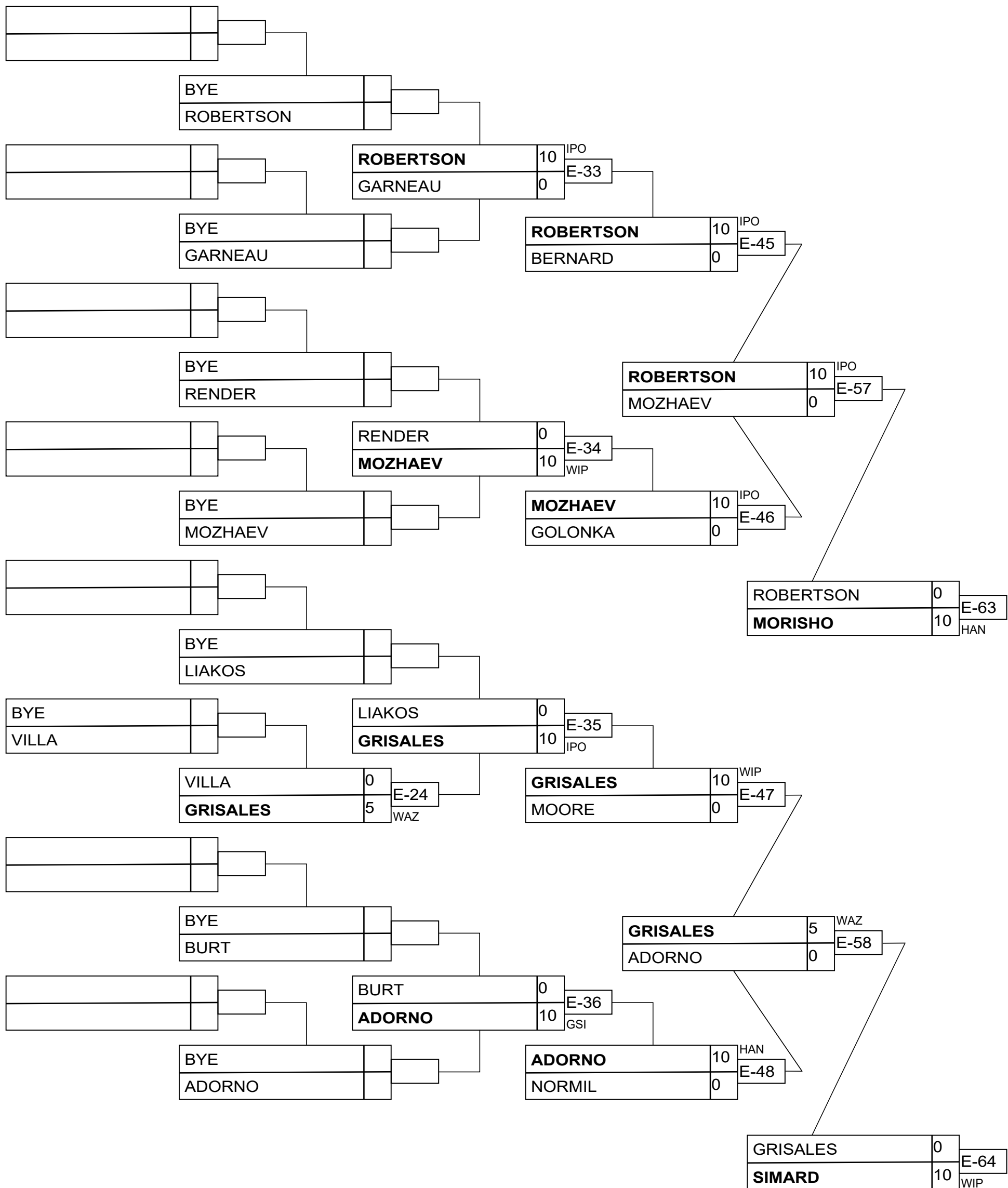

U18F -70

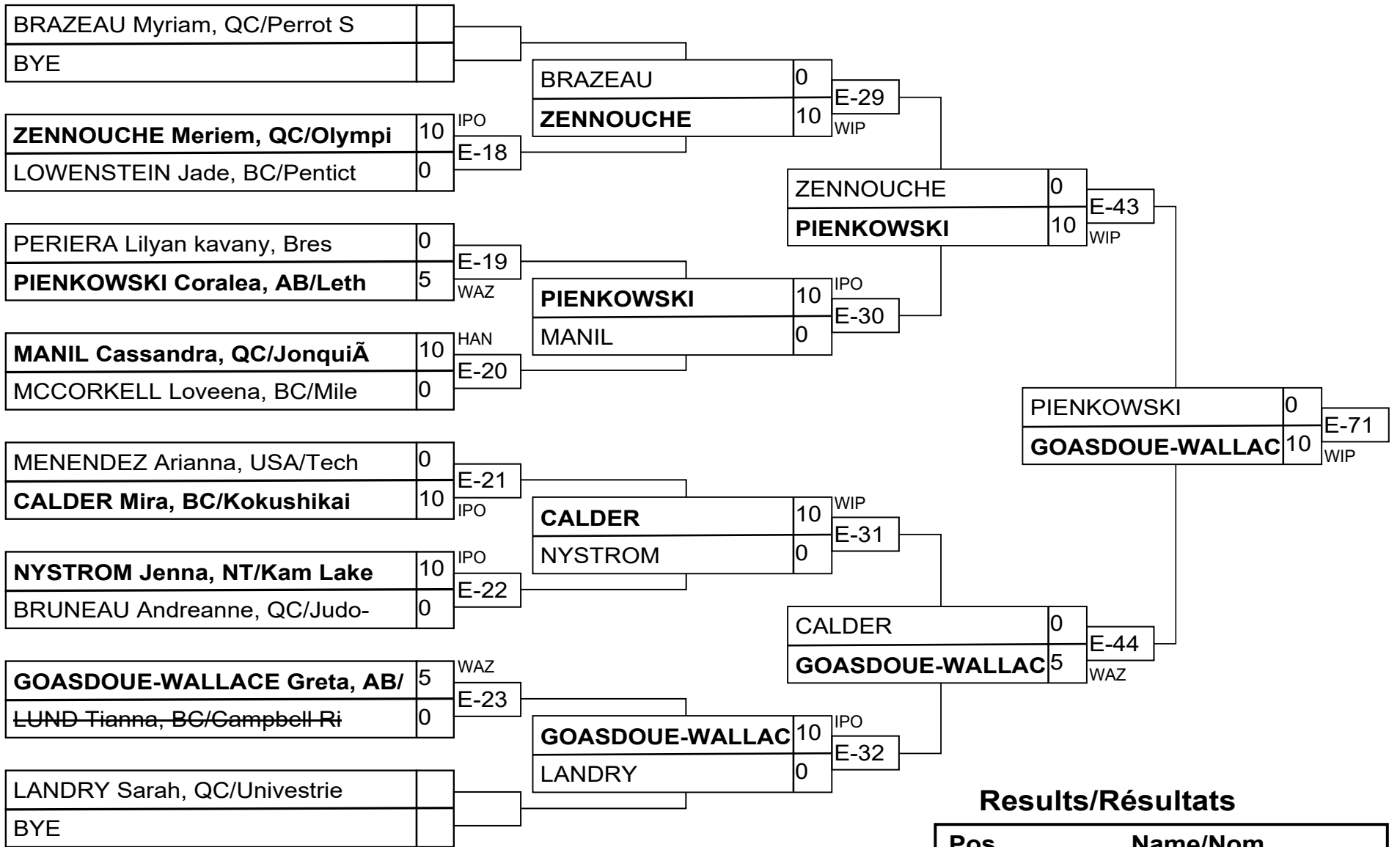

Results/Résultats

Pos	Name/Nom
1	GOASDOUE-WALLACE Greta,
2	PIENKOWSKI Coralea, AB/L
3	PERIERA Lilyan kavany, B
3	CALDER Mira, BC/Kokushik

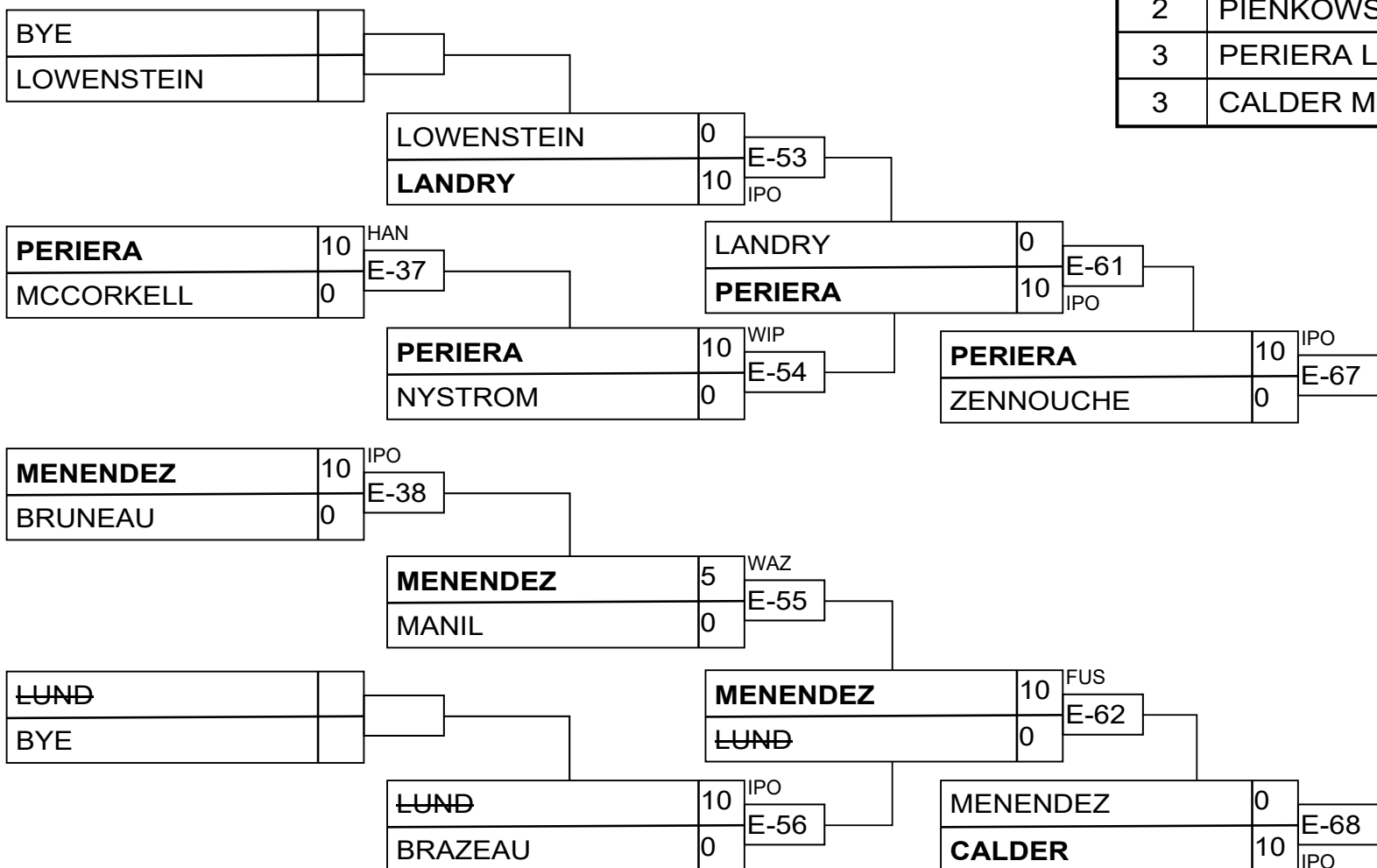

U18M -50

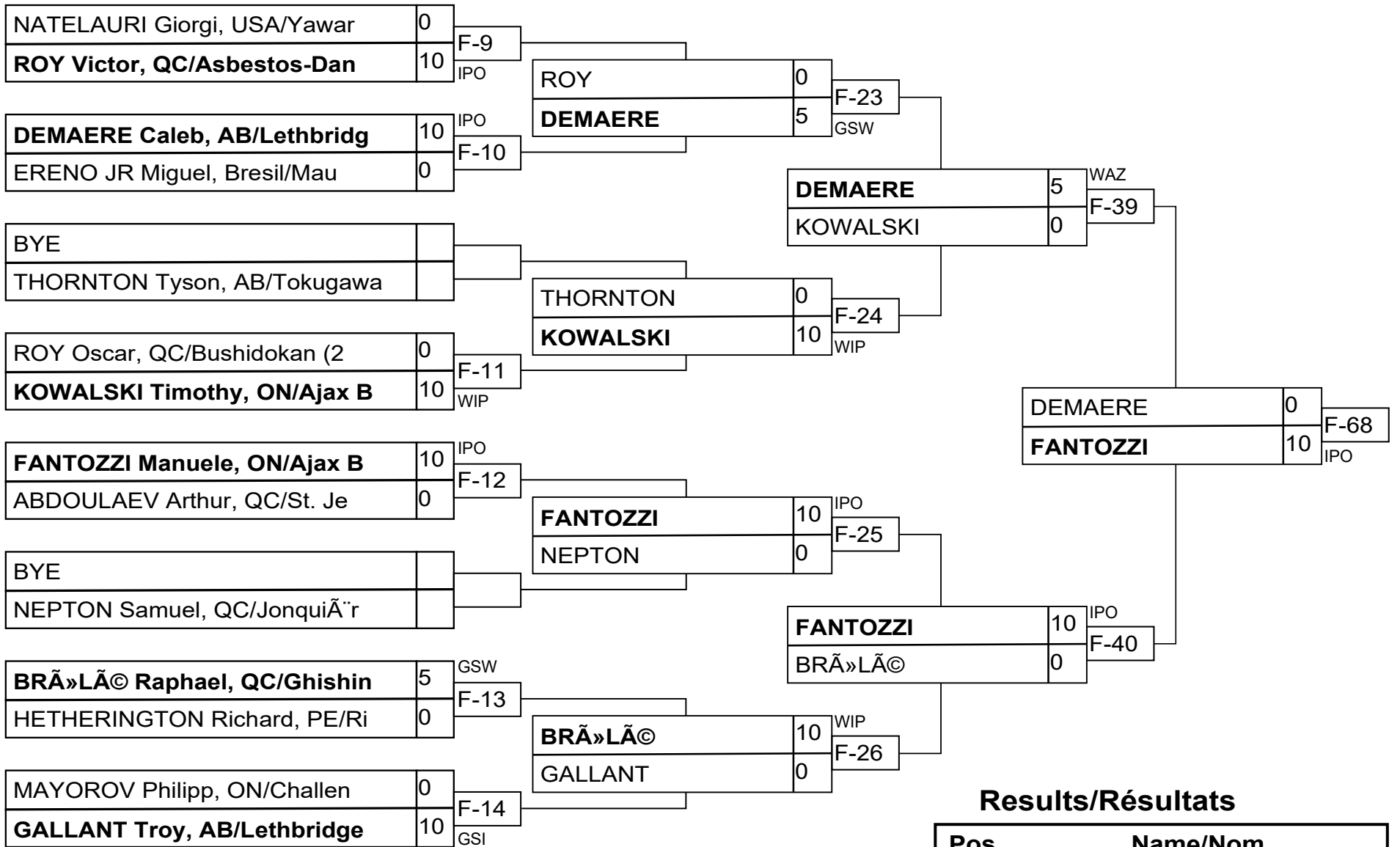

Results/Résultats

Pos	Name/Nom
1	FANTOZZI Manuele, ON/Aja
2	DEMAERE Caleb, AB/Lethbr
3	KOWALSKI Timothy, ON/Aja
3	ROY Victor, QC/Asbestos-

