

SenF -78

Compétiteurs/Competitors A

#	Nom/Name	Grade	Club	1	2	3	G/W	Pts	Pos
1	SYNOTT Josie-Anne (77,70)	1D	QC	XX		10	1	10	2
2	COPELAND Allayah (0,00)	1k	ON	10	XX	10	2	20	1
3	LEVESQUE Alyssa (0,00)	2k	NB			XX	0	0	3

Matches/Matches A

Match	Blanc/White			Bleu/Blue	Rés/Res	Tmp/Tim	Code
G-34	SYNOTT Josie-Anne	1	2	COPELAND Allayah	0 - 10	0:00	IPO
G-45	SYNOTT Josie-Anne	1	3	LEVESQUE Alyssa	10 - 0	0:00	IPO
G-53	COPELAND Allayah	2	3	LEVESQUE Alyssa	10 - 0	0:00	IPO

Compétiteurs/Competitors B

#	Nom/Name	Grade	Club	4	5	6	G/W	Pts	Pos
4	SARAH Mazouz (0,00)	1D	GBN	XX	10	10	2	20	1
5	STOUT Nicole (0,00)	1D	USA		XX		0	0	3
6	COULOMBE Mina (0,00)	2D	QC		10	XX	1	10	2

Matches/Matches B

Match	Blanc/White			Bleu/Blue	Rés/Res	Tmp/Tim	Code
G-35	SARAH Mazouz	4	5	STOUT Nicole	10 - 0	0:00	IPO
G-46	SARAH Mazouz	4	6	COULOMBE Mina	10 - 0	0:00	IPO
G-54	STOUT Nicole	5	6	COULOMBE Mina	0 - 10	0:00	IPO

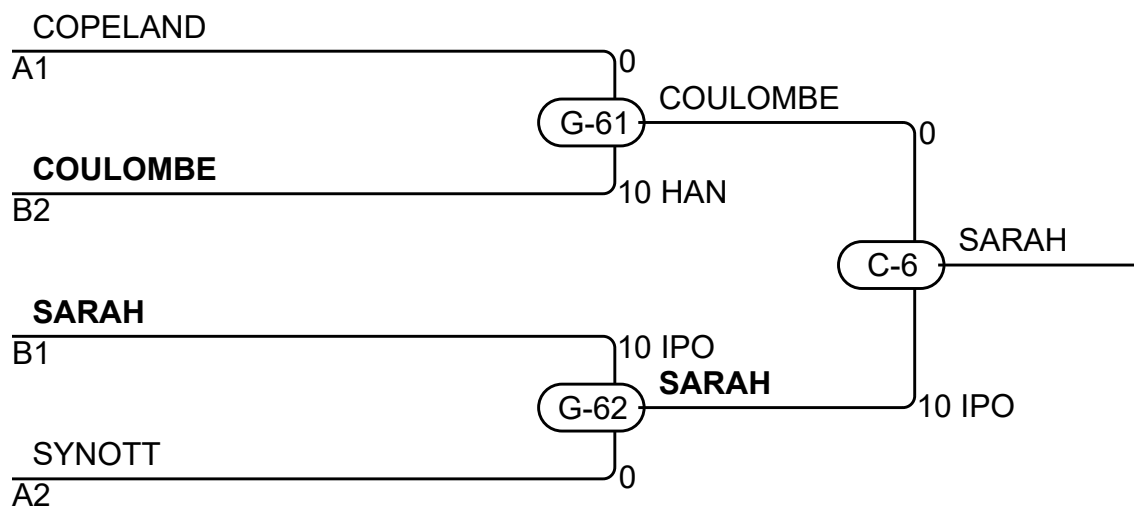

Résultats/Results

Pos	Nom/Name
1	SARAH Mazouz, GBN
2	COULOMBE Mina, QC
3	COPELAND Allayah, ON
3	SYNOTT Josie-Anne, QC

SenM -100

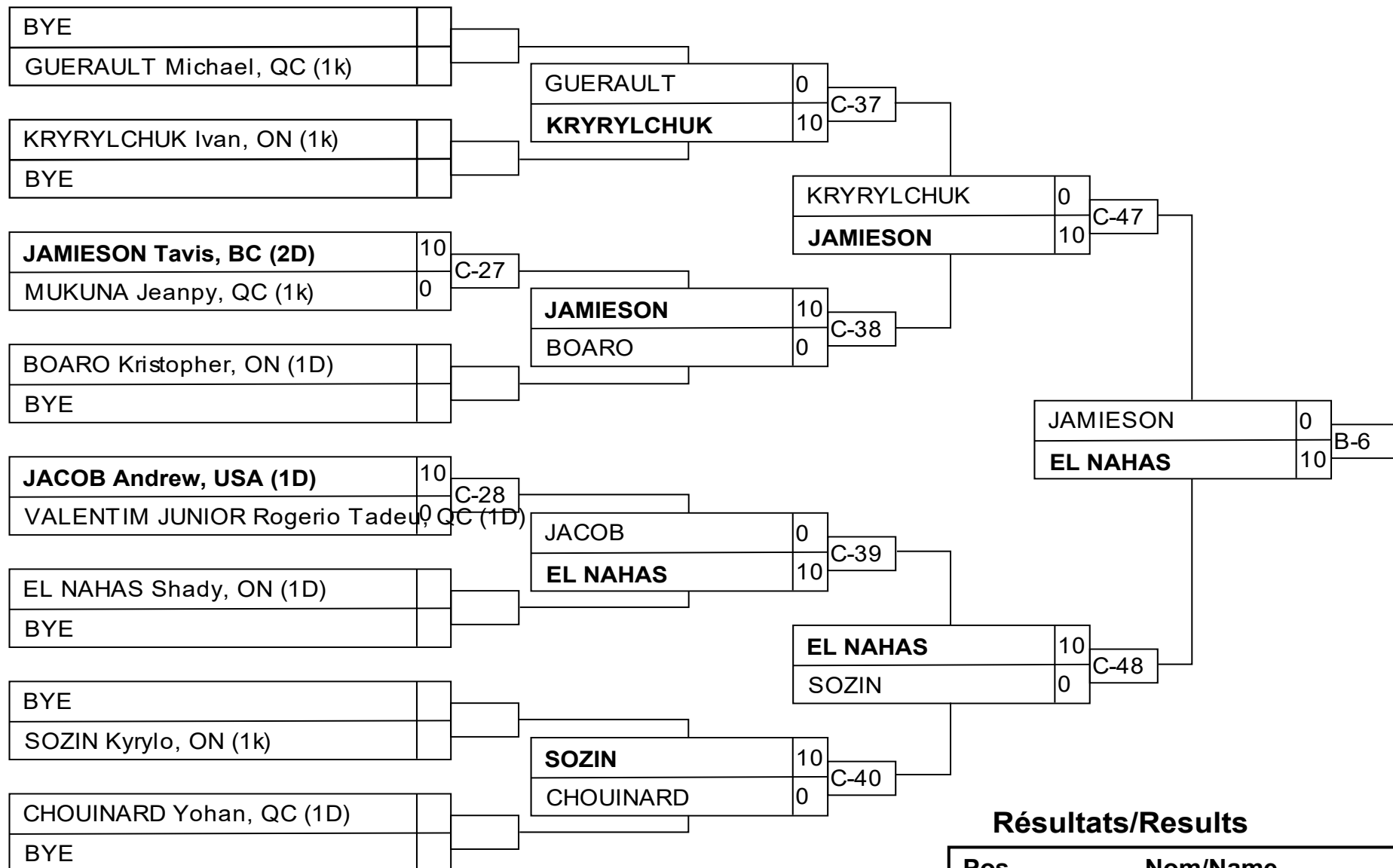

Résultats/Results

Pos	Nom/Name
1	EL NAHAS Shady, ON (1D)
2	JAMIESON Tavis, BC (2D)
3	JACOB Andrew, USA (1D)
3	SOZIN Kyrylo, ON (1k)

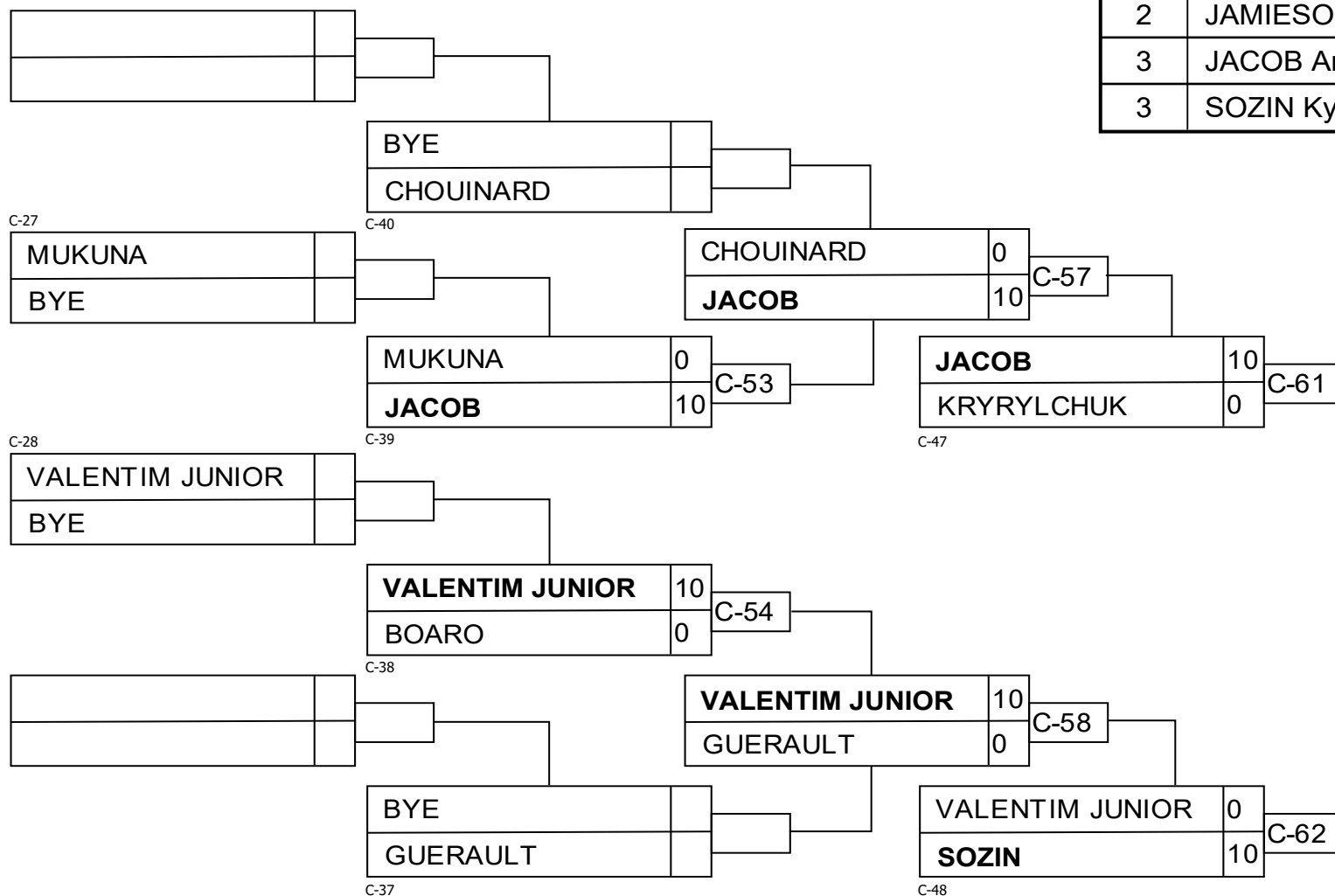

SenM -60

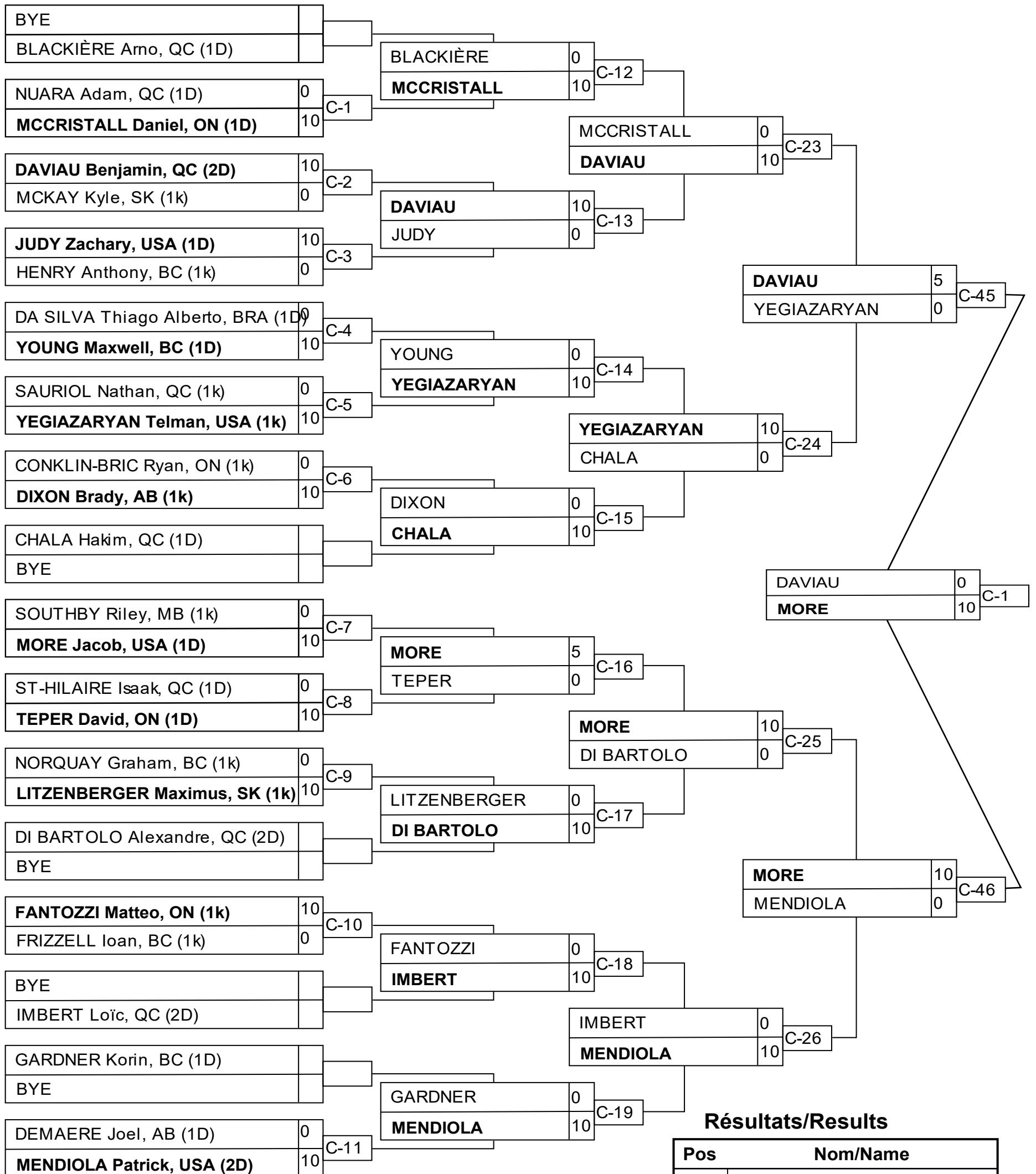

Résultats/Results

Pos	Nom/Name
1	MORE Jacob, USA (1D)
2	DAVIAU Benjamin, QC (2D)
3	DI BARTOLO Alexandre, QC (2D)
3	MENDIOLA Patrick, USA (2D)

SenM -60

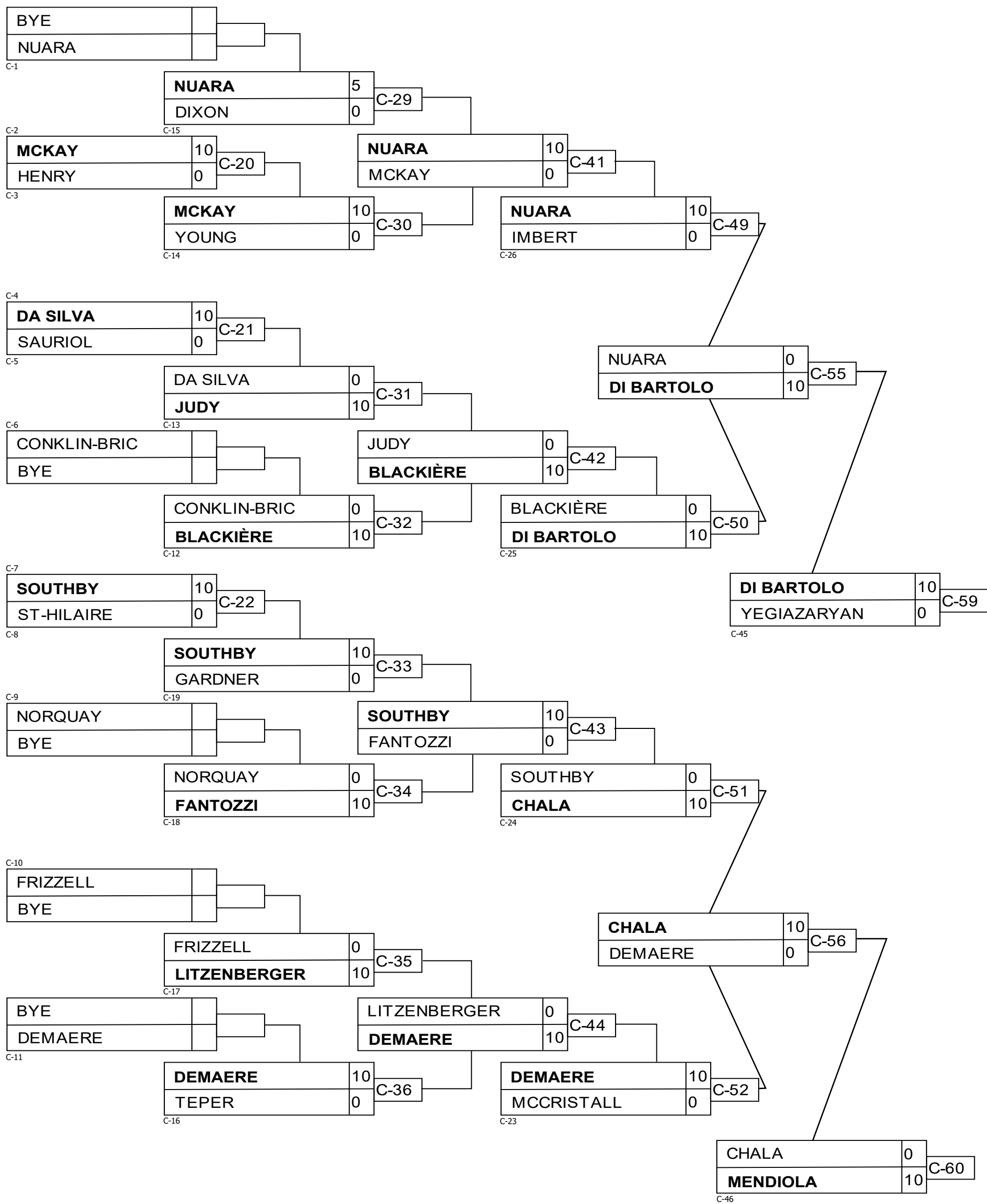

SenM -66

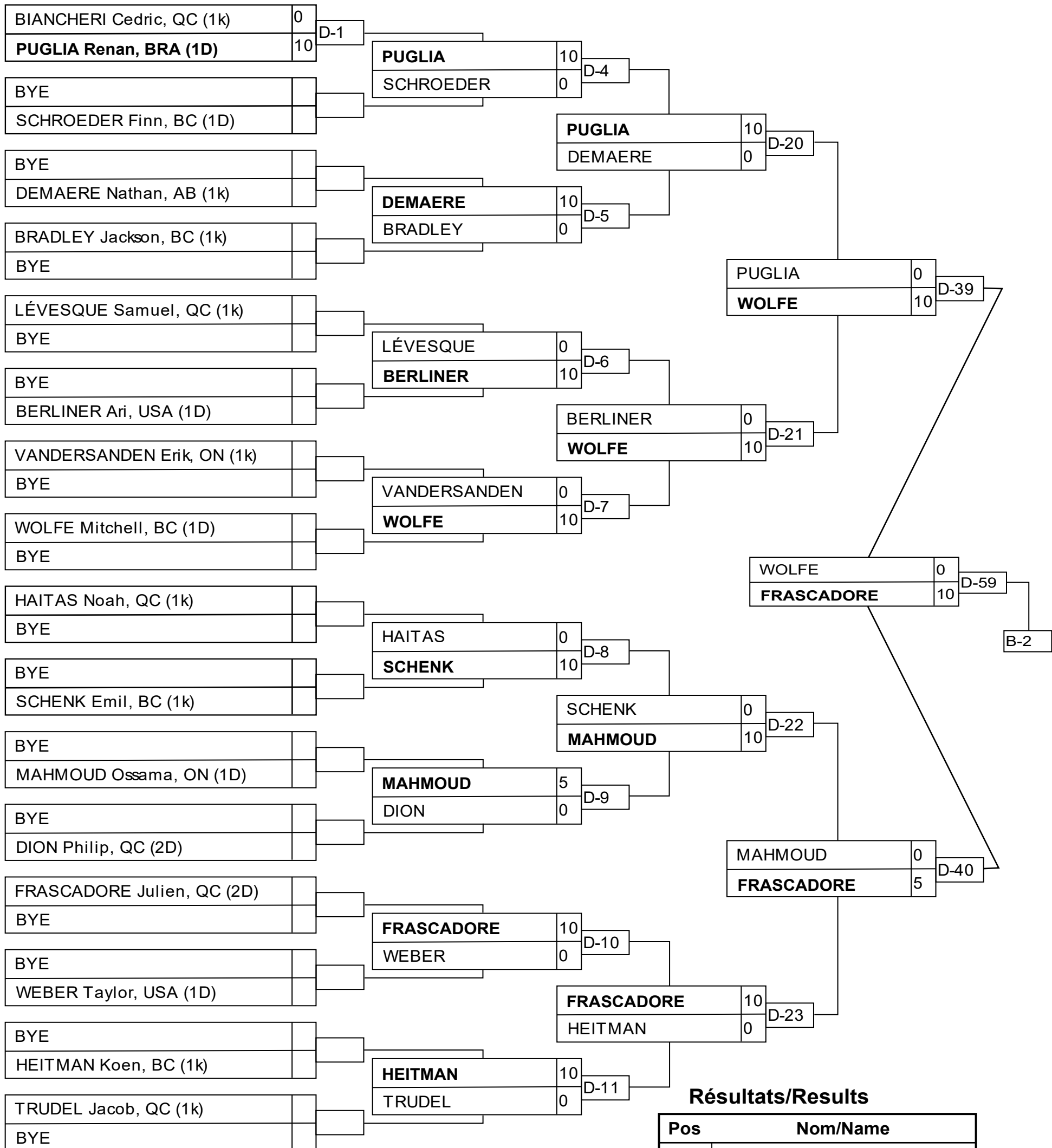

Résultats/Results

Pos	Nom/Name
1	VALOIS Jacob, QC (2D)
2	FRASCADORE Julien, QC (2D)
3	SCHROEDER Finn, BC (1D)
3	WOLFE Mitchell, BC (1D)

SenM -66

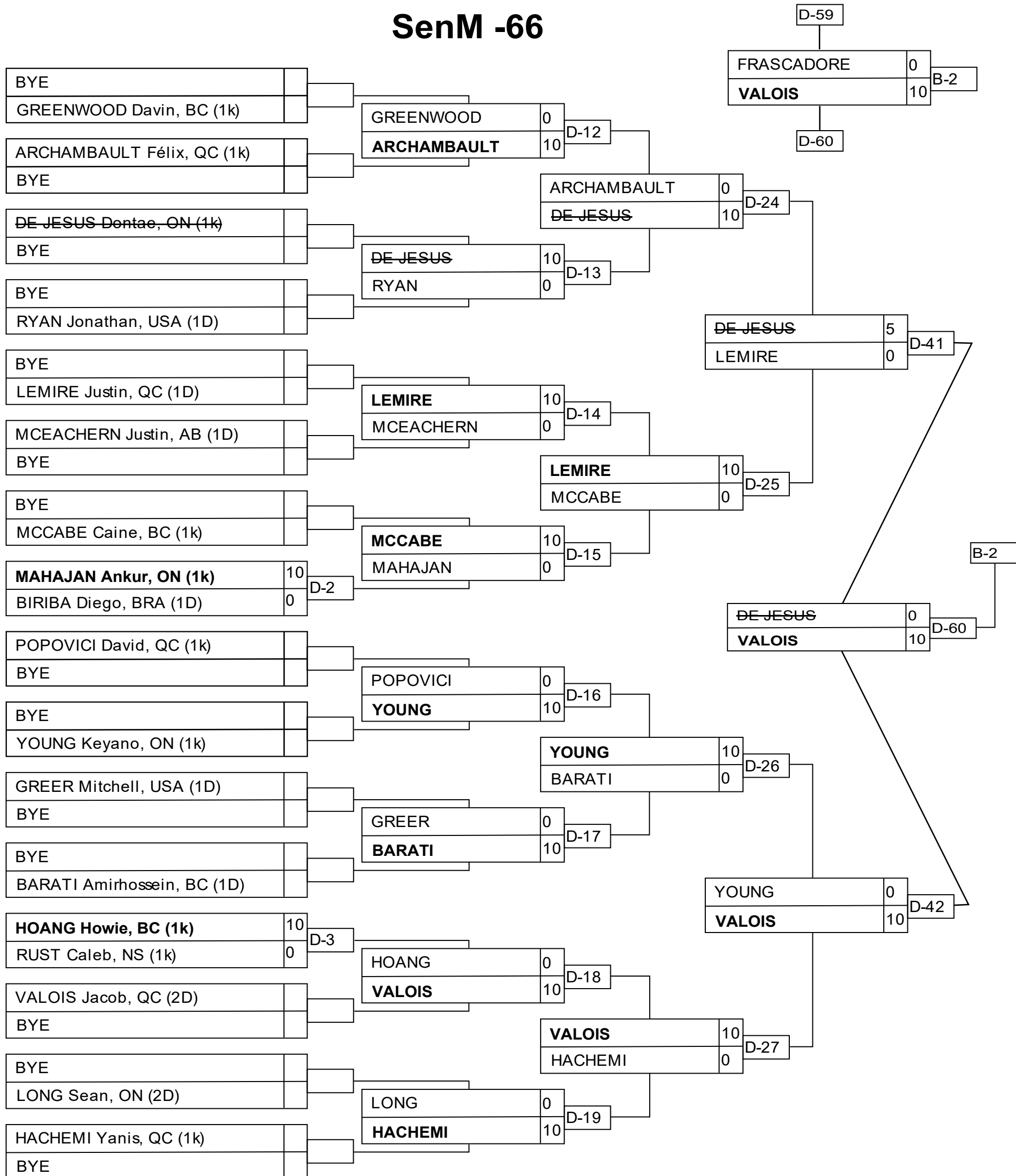

SenM-66

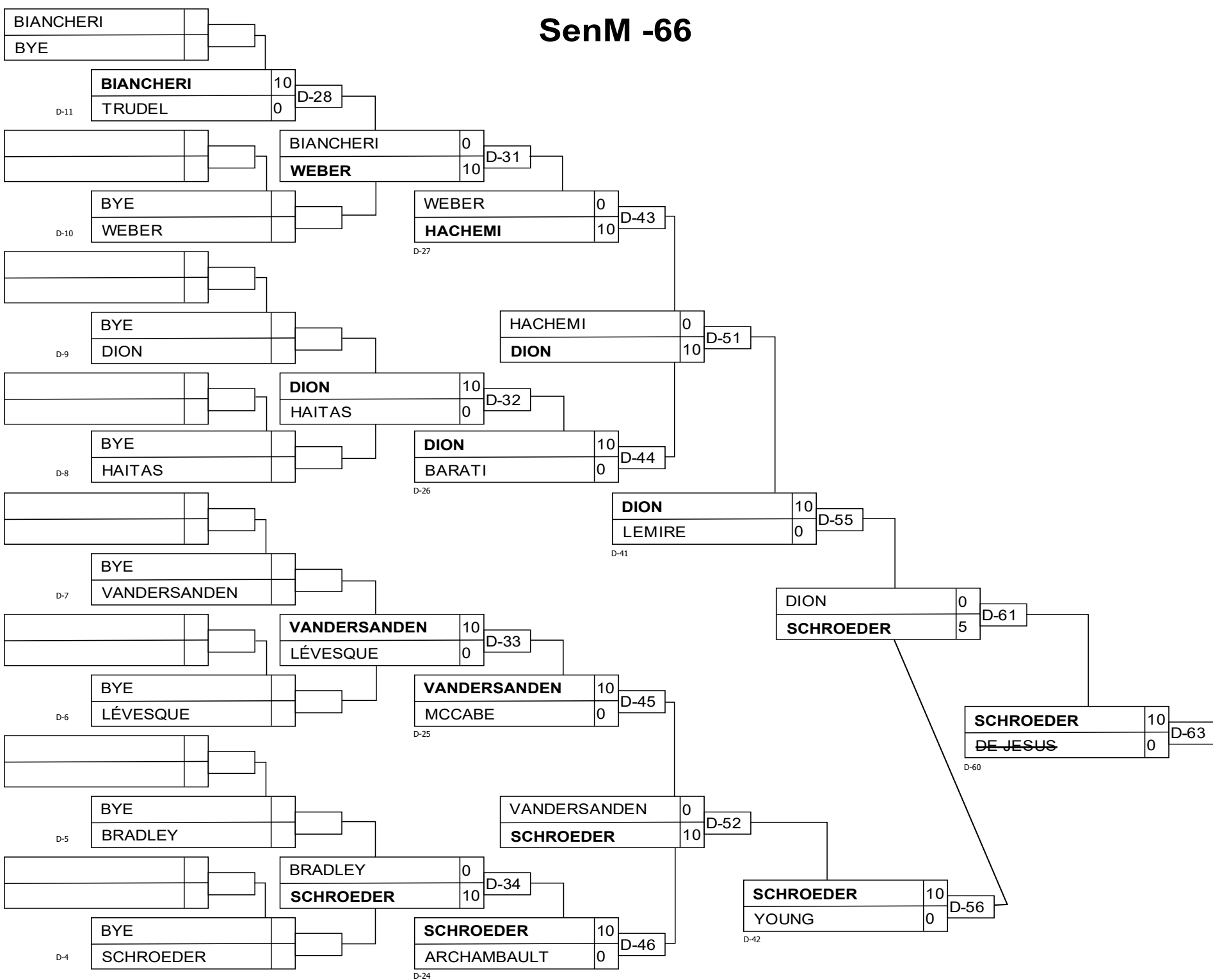

SenM-66

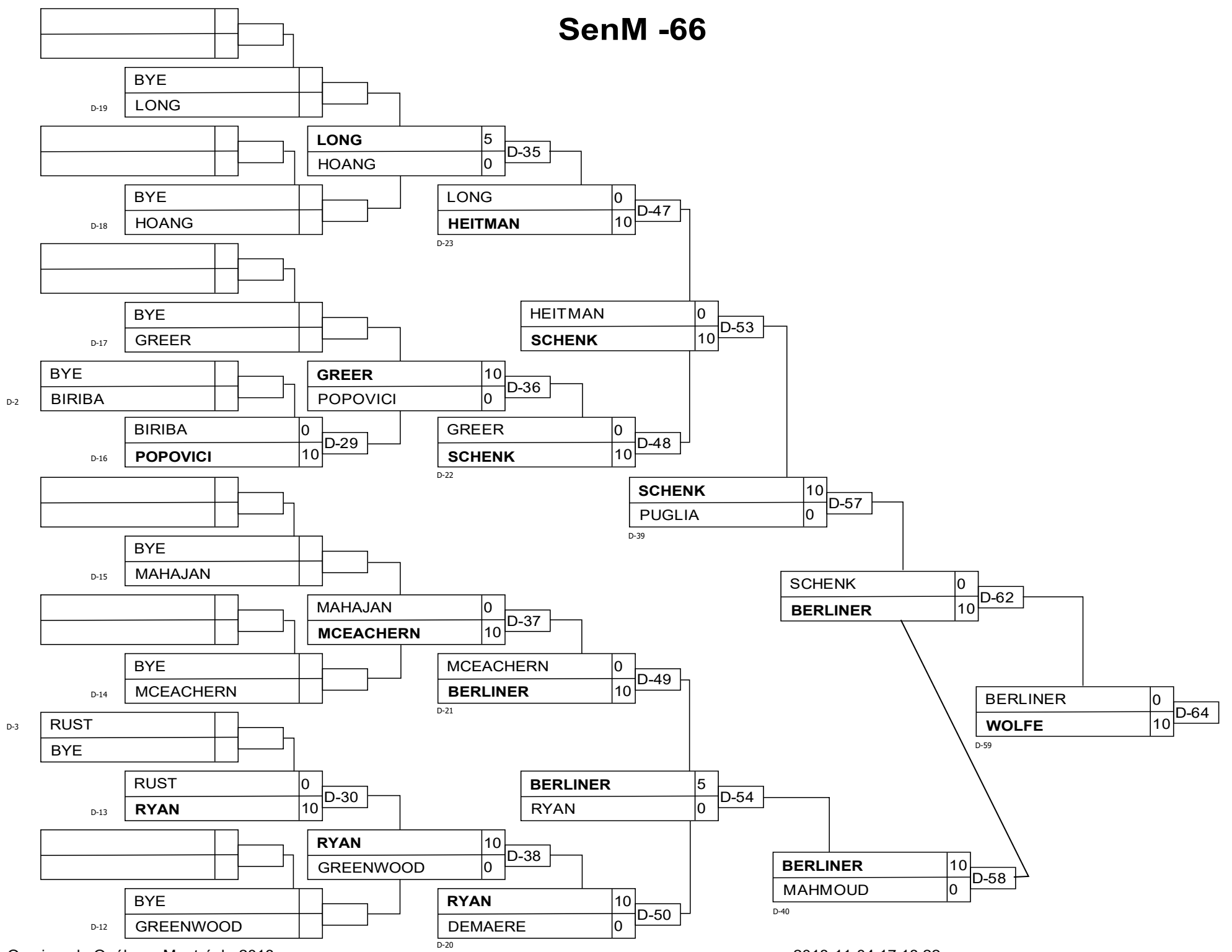

SenM -73

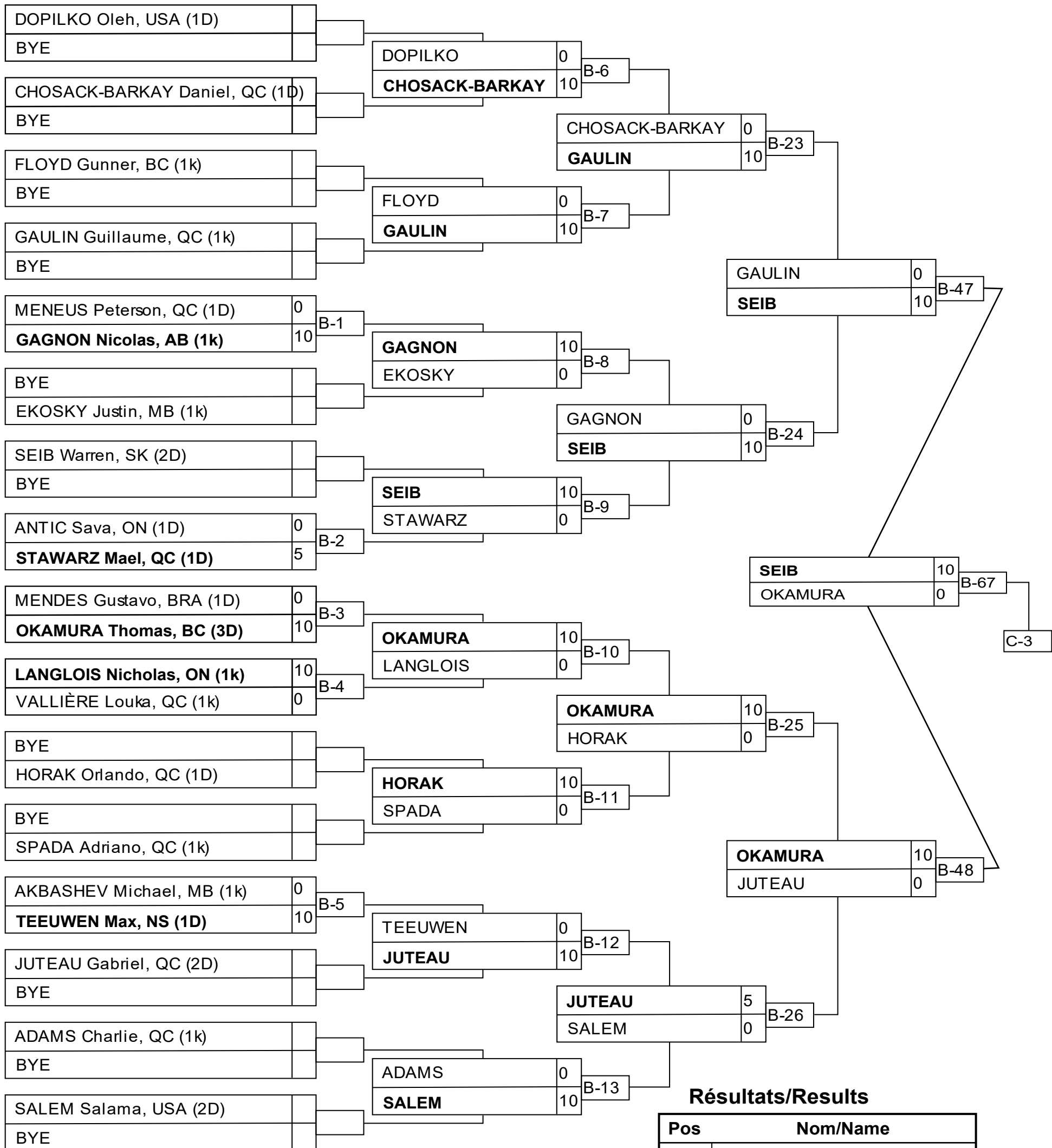

Résultats/Results

Pos	Nom/Name
1	GABUN Constantin, QC (1D)
2	SEIB Warren, SK (2D)
3	VACC Gabriel, QC (2D)
3	JUTEAU Gabriel, QC (2D)

SenM -73

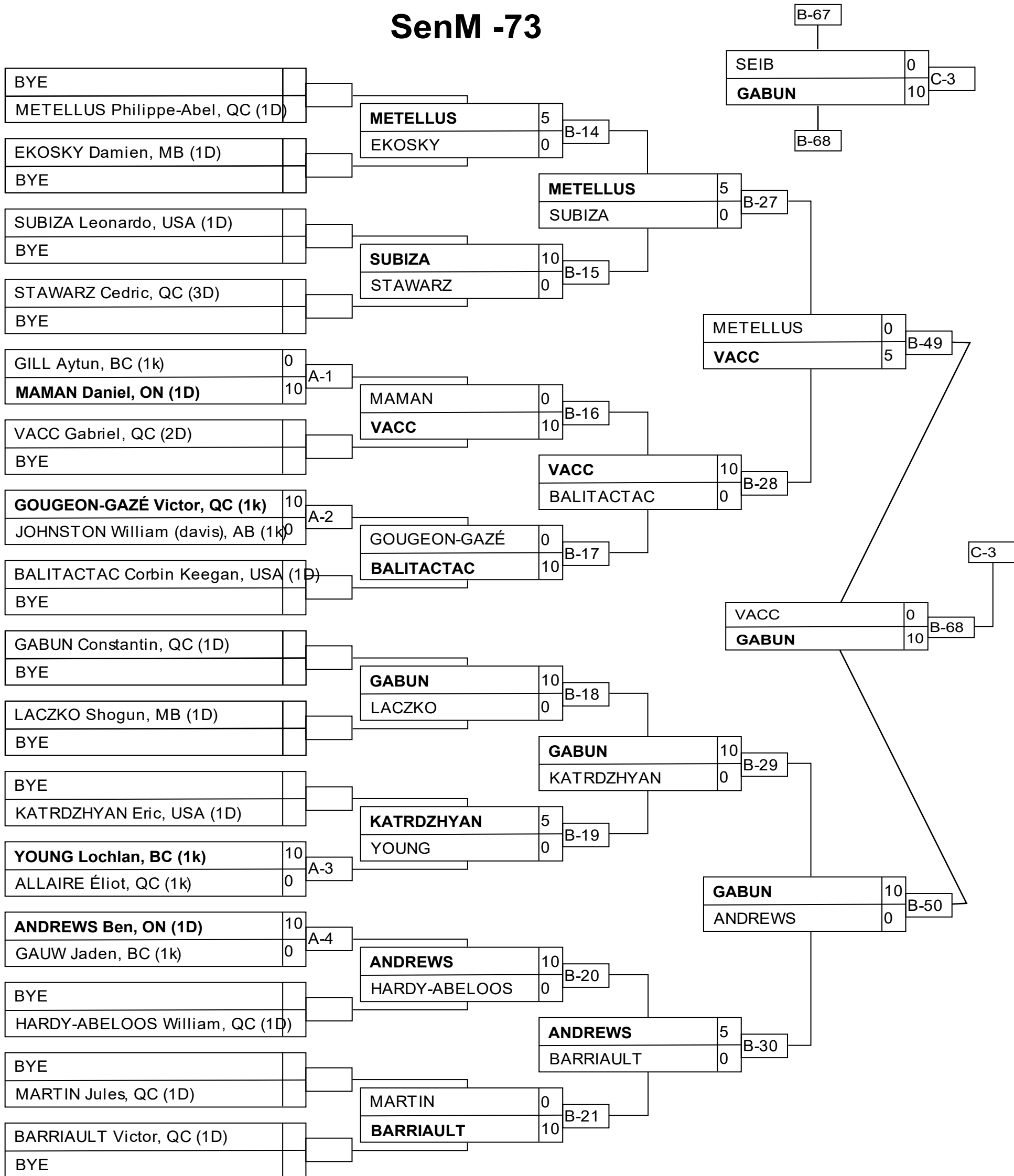

SenM-73

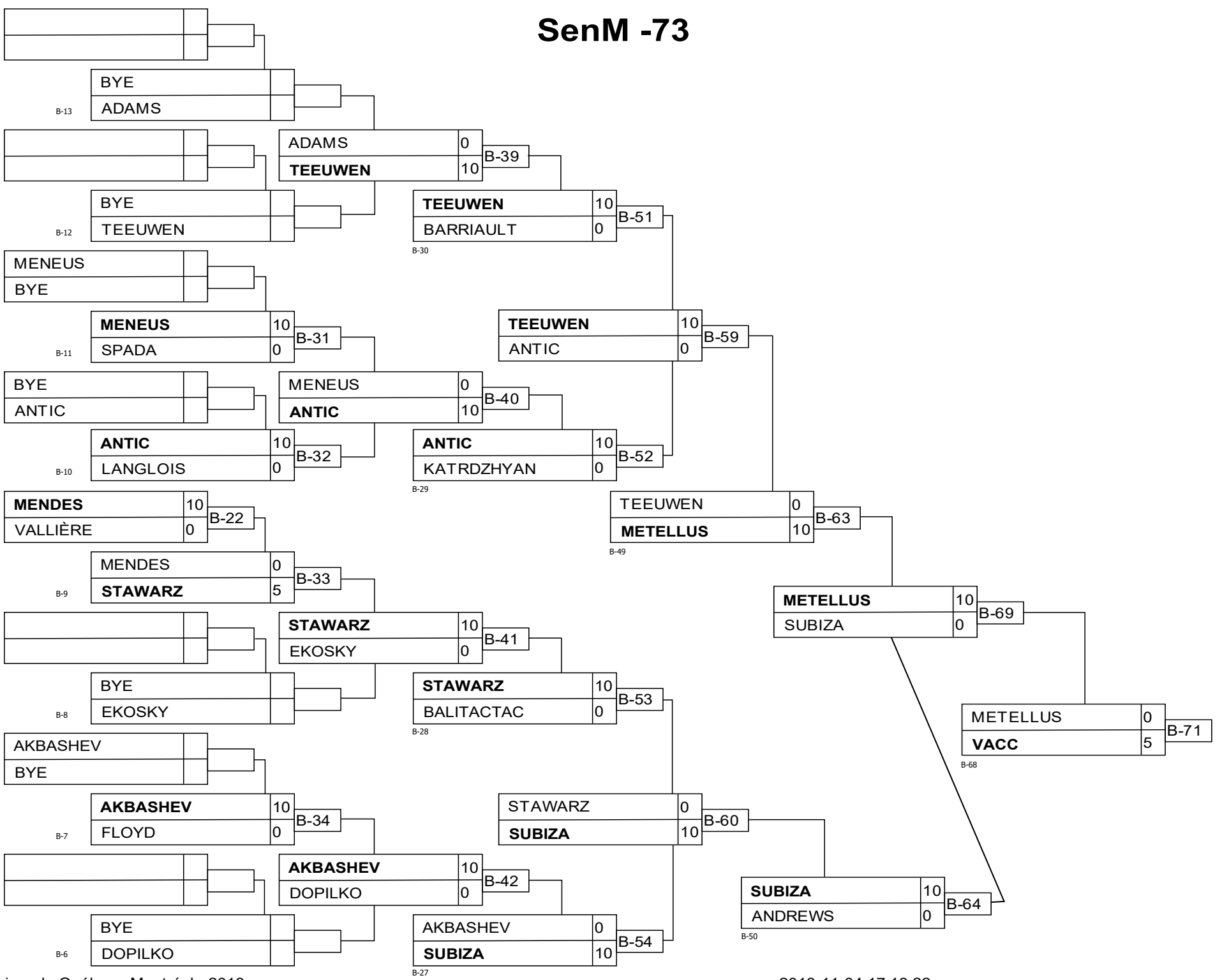

SenM-73

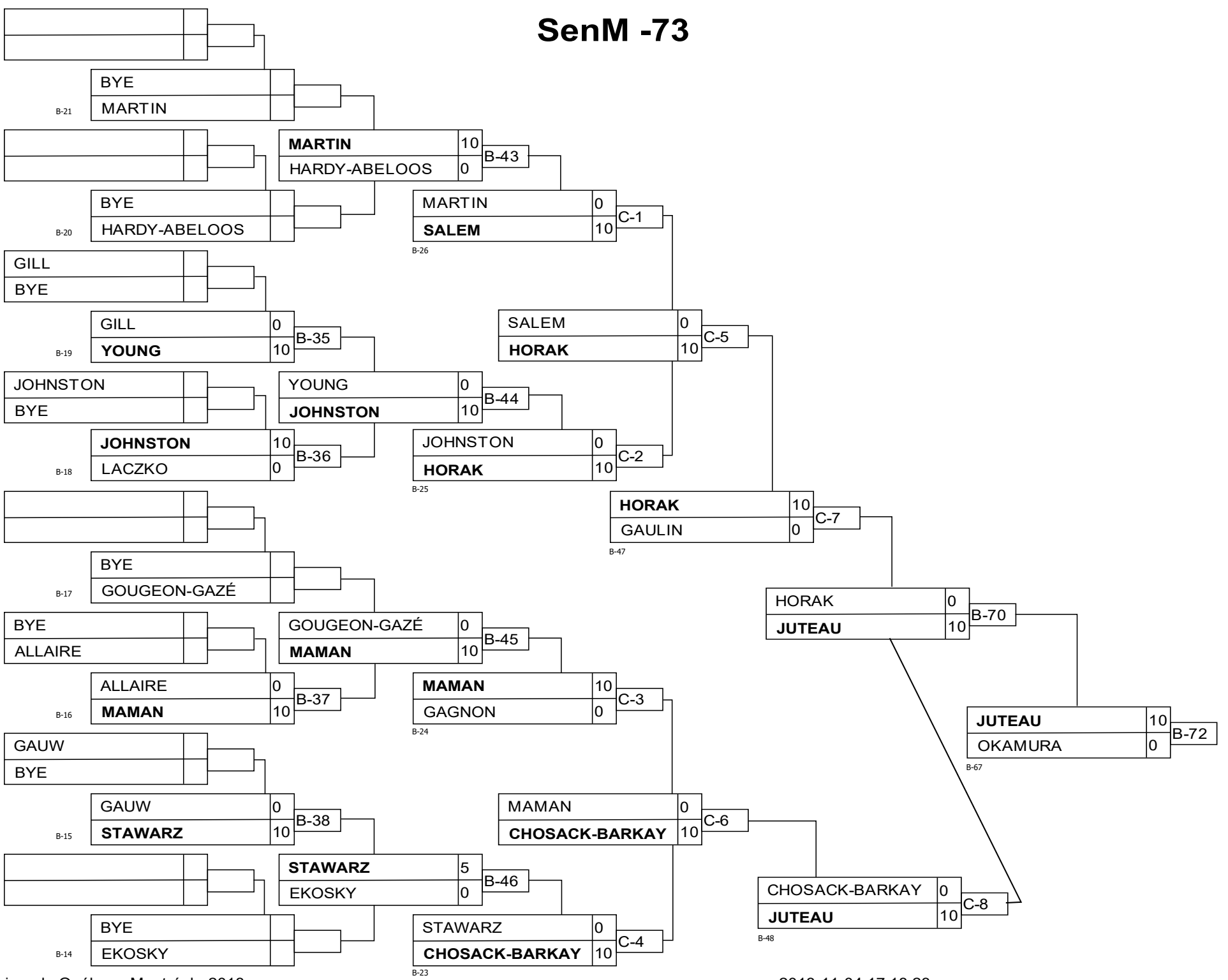

SenM -81

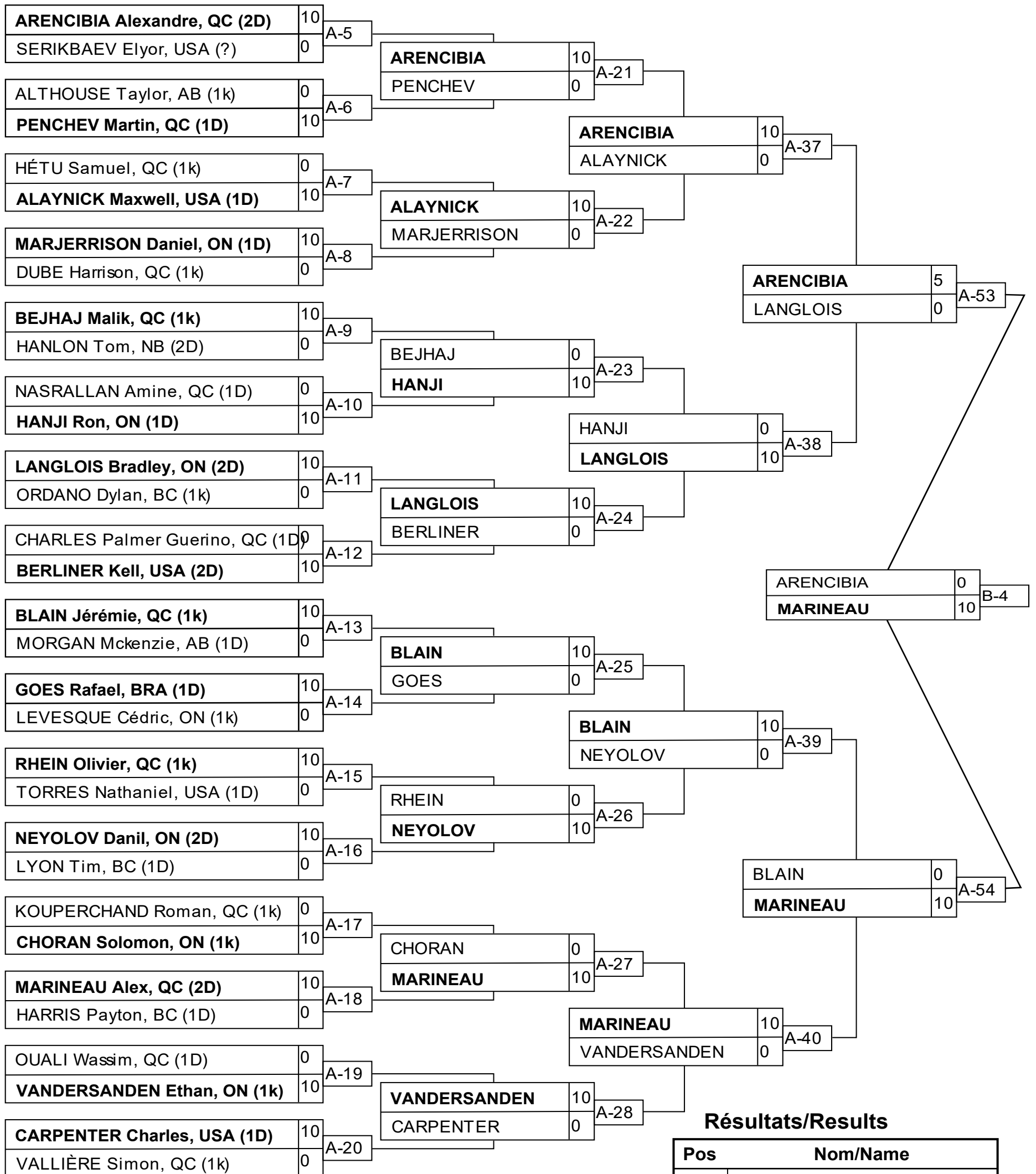

Résultats/Results

Pos	Nom/Name
1	MARINEAU Alex, QC (2D)
2	ARENCIBIA Alexandre, QC (2D)
3	LANGLOIS Bradley, ON (2D)
3	BLAIN Jérémie, QC (1k)

SenM -81

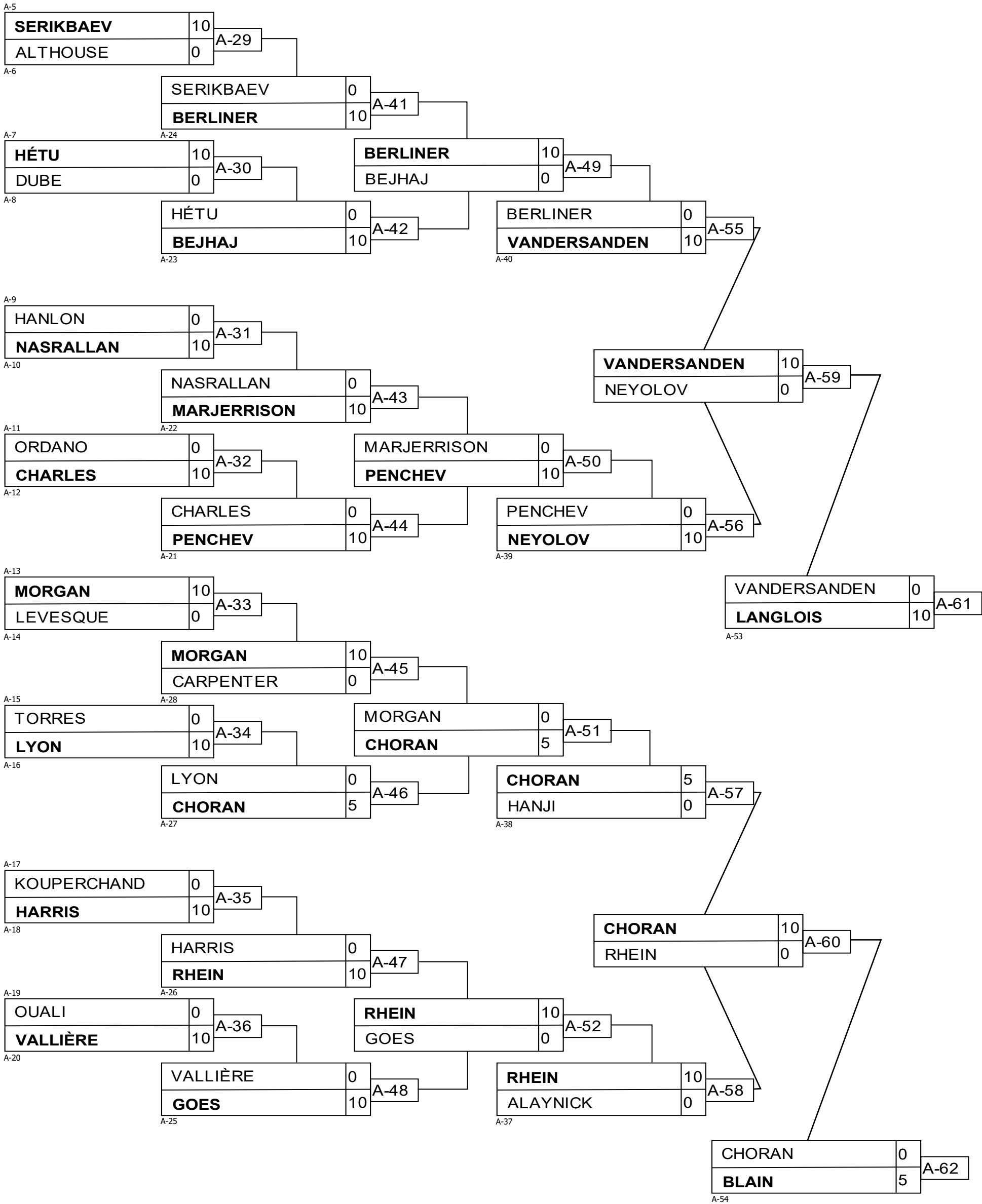

SenF -48

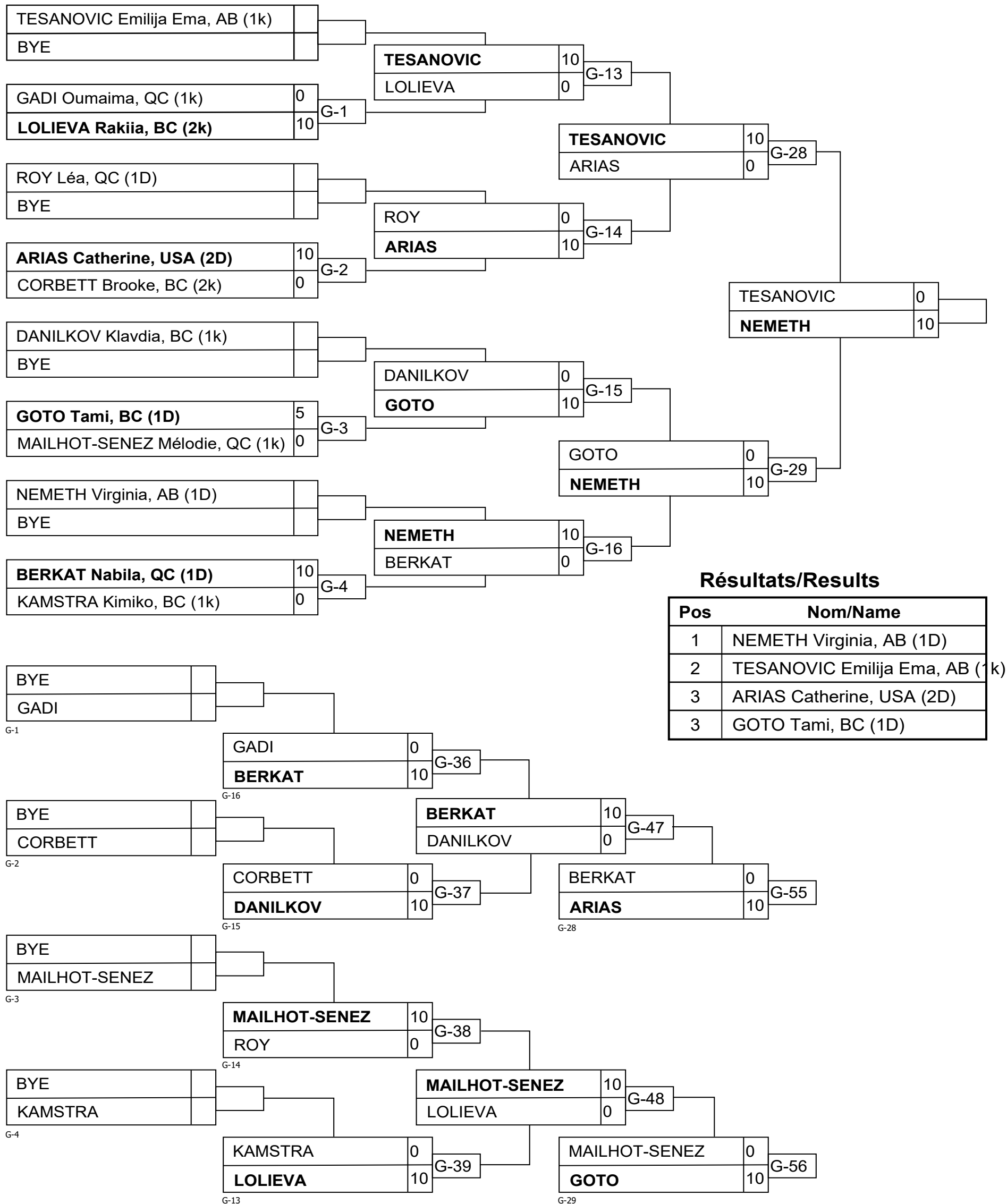

SenF -52

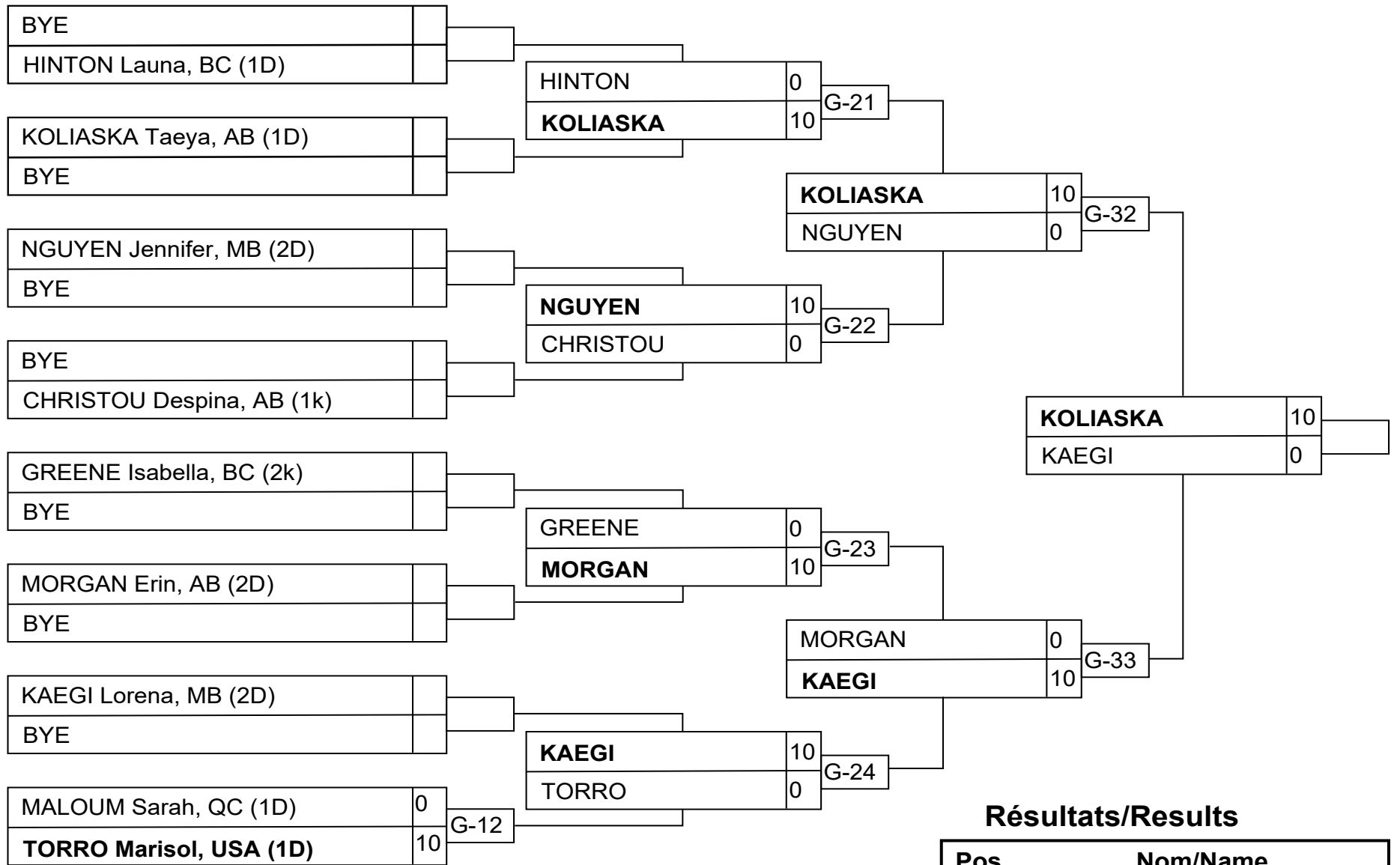

Résultats/Results

Pos	Nom/Name
1	KOLIASKA Taeya, AB (1D)
2	KAEGI Lorena, MB (2D)
3	TORRO Marisol, USA (1D)
3	MORGAN Erin, AB (2D)

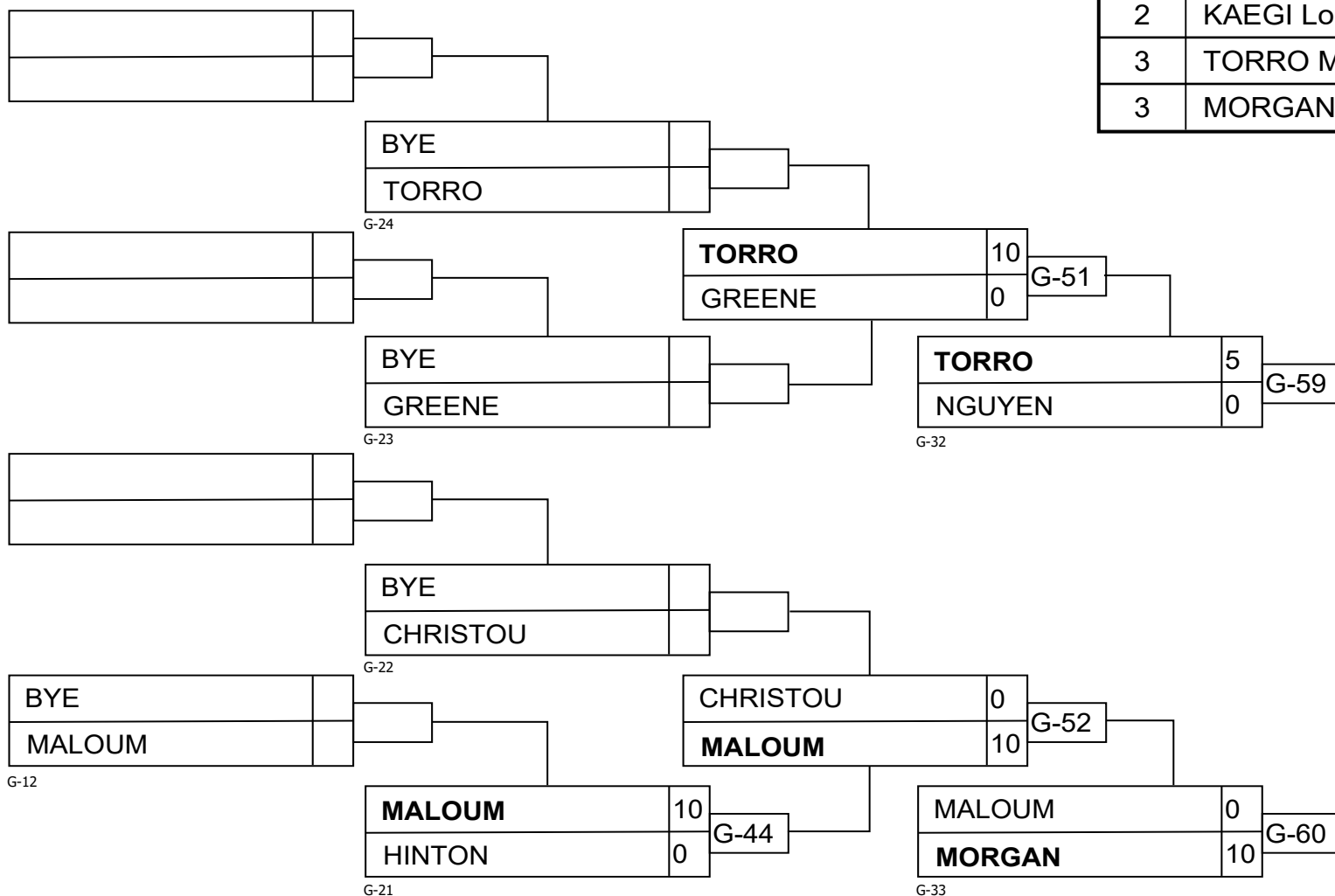

SenF -57

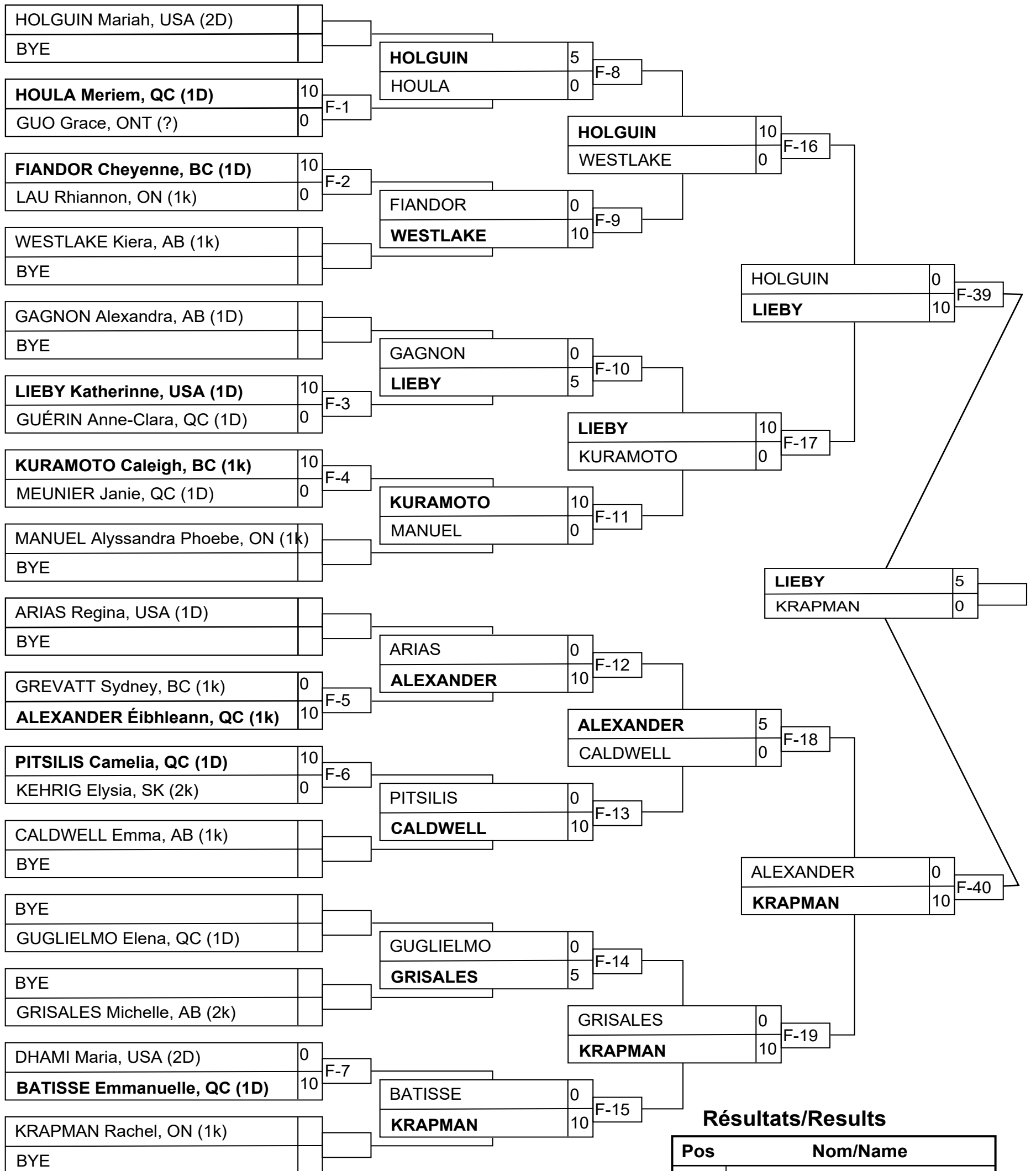

Résultats/Results

Pos	Nom/Name
1	LIEBY Katherinne, USA (1D)
2	KRAPMAN Rachel, ON (1k)
3	HOLGUIN Mariah, USA (2D)
3	PITSILIS Camelia, QC (1D)

SenF -57

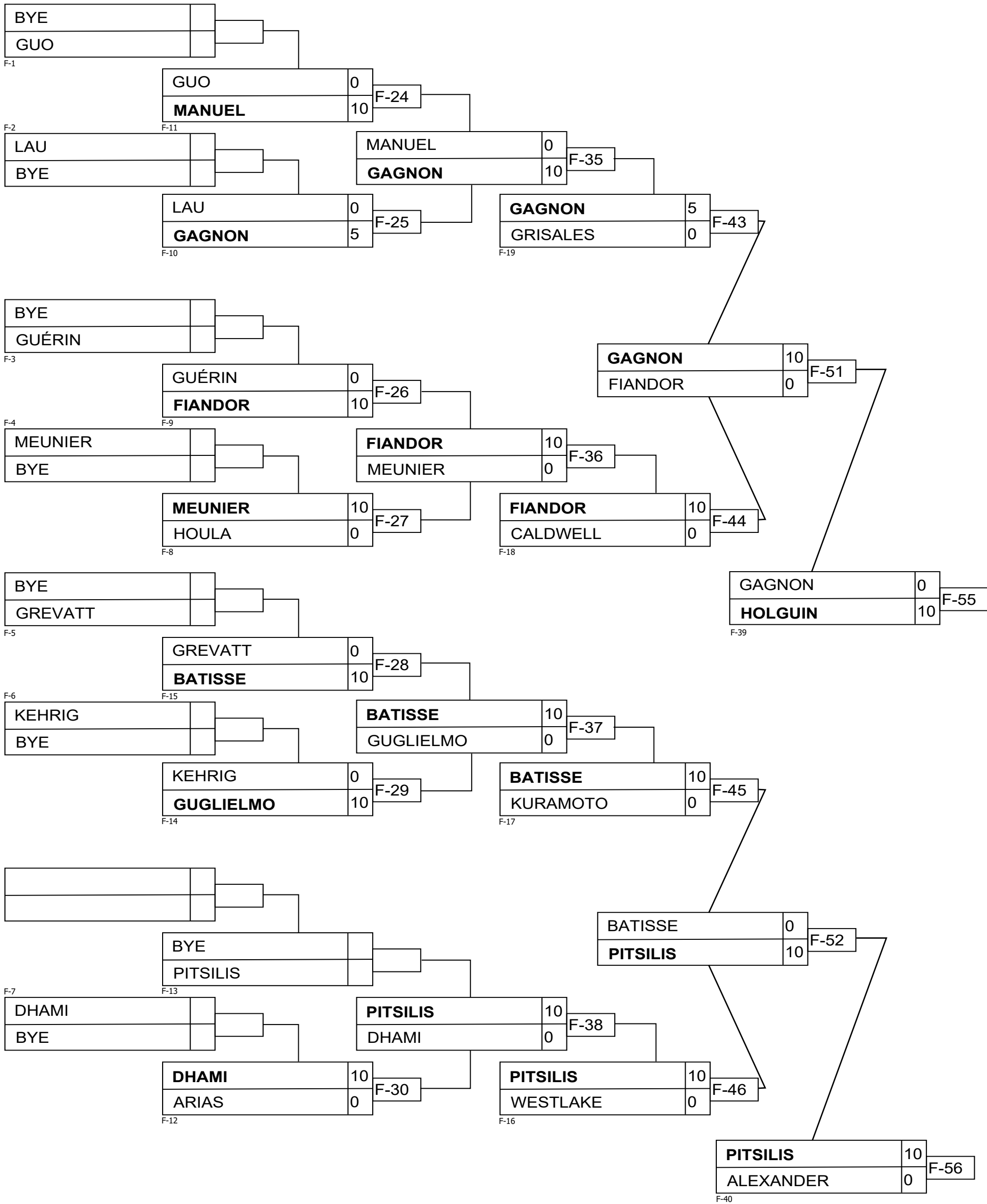

SenF -63

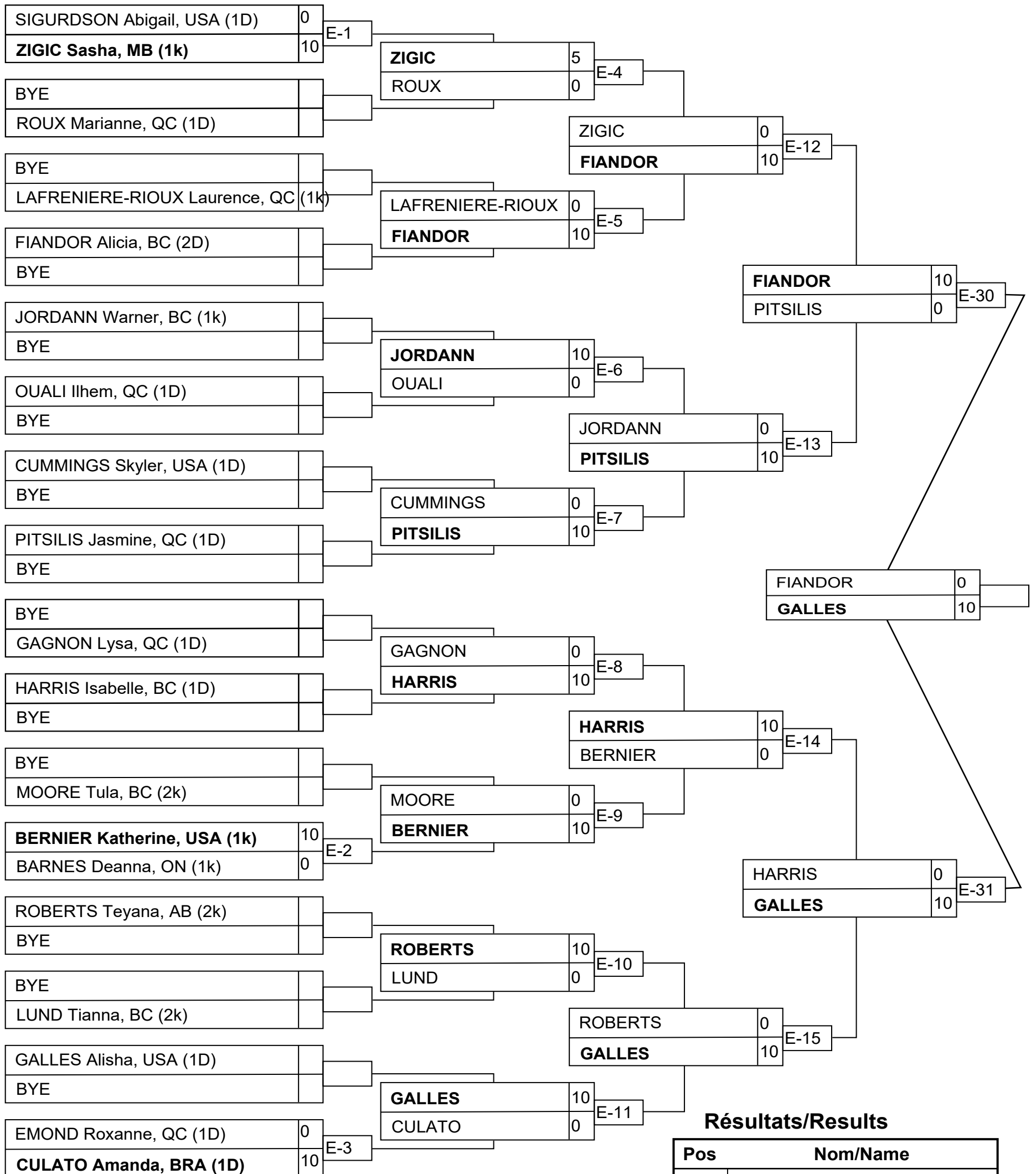

Résultats/Results

Pos	Nom/Name
1	GALLES Alisha, USA (1D)
2	FIANDOR Alicia, BC (2D)
3	OUALI Ilhem, QC (1D)
3	HARRIS Isabelle, BC (1D)

SenF -70

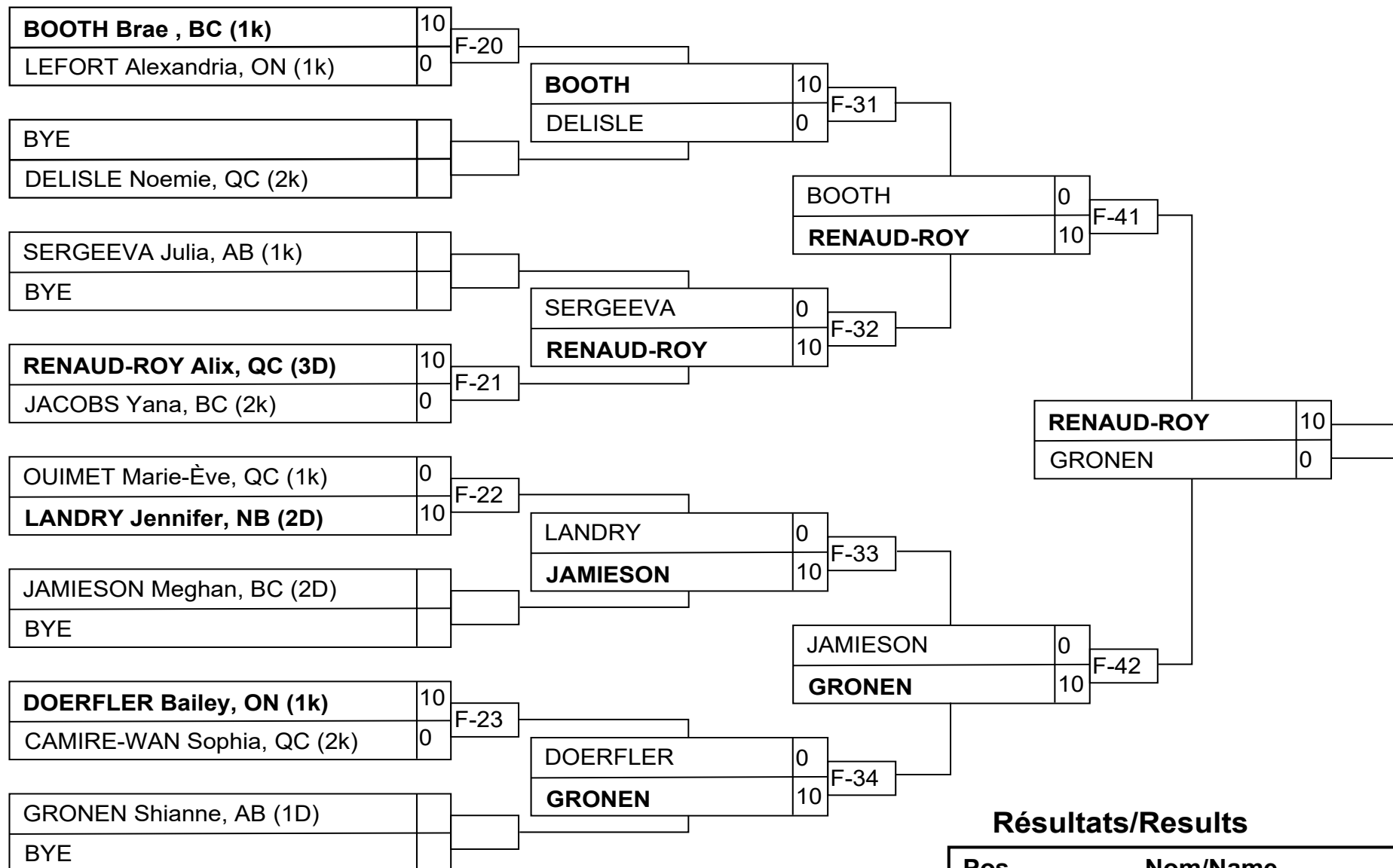

Résultats/Results

Pos	Nom/Name
1	RENAUD-ROY Alix, QC (3D)
2	GRONEN Shianne, AB (1D)
3	LEFORT Alexandria, ON (1k)
3	JAMIESON Meghan, BC (2D)

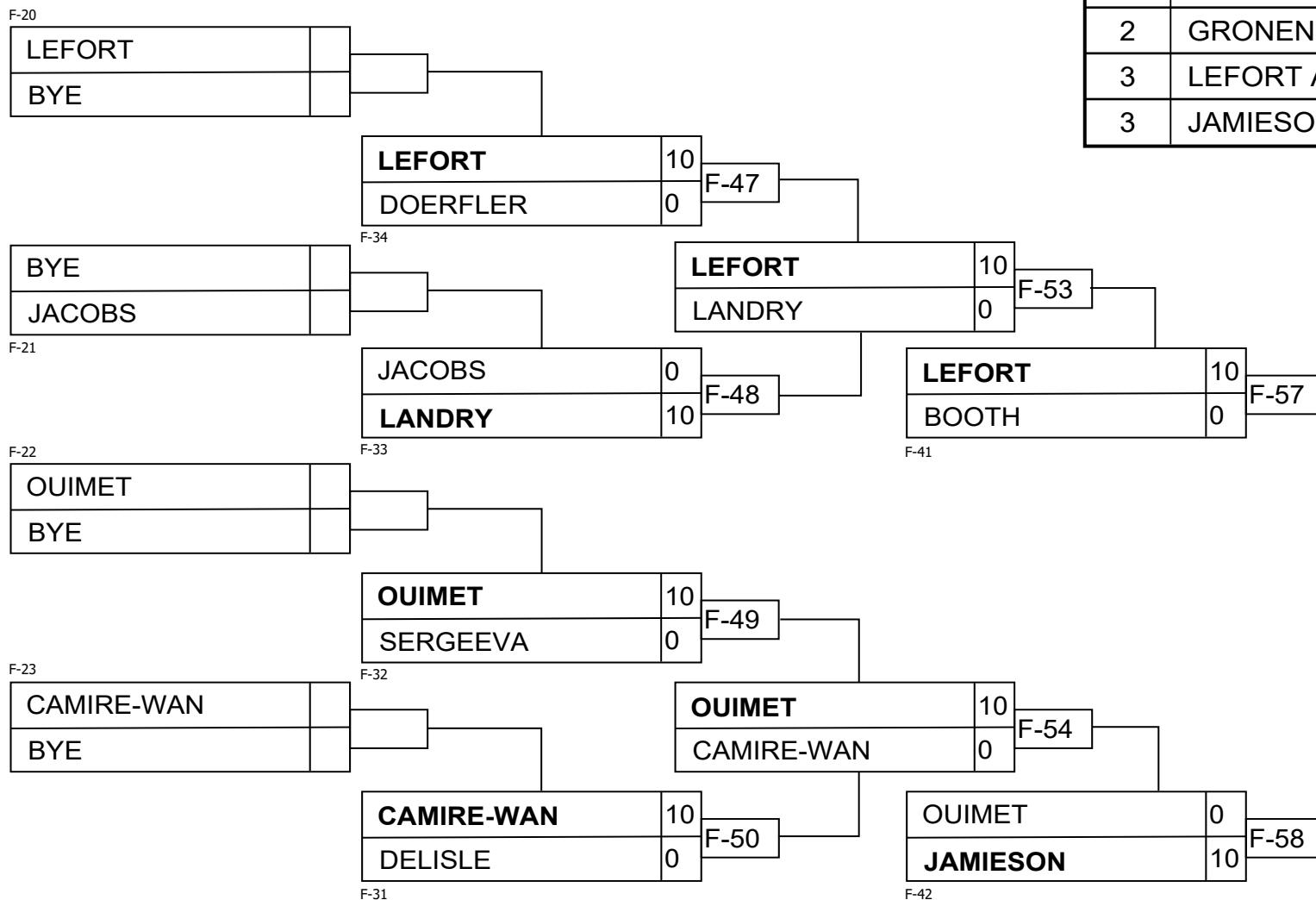

SenF -78

Compétiteurs/Competitors A

#	Nom/Name	Grade	Club	1	2	3	G/W	Pts	Pos
1	SYNOTT Josie-Anne (77,70)	1D	QC	XX		10	1	10	2
2	COPELAND Allayah (0,00)	1k	ON	10	XX	10	2	20	1
3	LEVESQUE Alyssa (0,00)	2k	NB			XX	0	0	3

Matches/Matches A

Match	Blanc/White			Bleu/Blue	Rés/Res	Tmp/Tim	Code
G-34	SYNOTT Josie-Anne	1	2	COPELAND Allayah	0 - 10	3:01	IPO
G-45	SYNOTT Josie-Anne	1	3	LEVESQUE Alyssa	10 - 0	0:20	IPO
G-53	COPELAND Allayah	2	3	LEVESQUE Alyssa	10 - 0	0:16	IPO

Compétiteurs/Competitors B

#	Nom/Name	Grade	Club	4	5	6	G/W	Pts	Pos
4	SARAH Mazouz (0,00)	1D	GBN	XX	10	10	2	20	1
5	STOUT Nicole (0,00)	1D	USA		XX		0	0	3
6	COULOMBE Mina (0,00)	2D	QC		10	XX	1	10	2

Matches/Matches B

Match	Blanc/White			Bleu/Blue	Rés/Res	Tmp/Tim	Code
G-35	SARAH Mazouz	4	5	STOUT Nicole	10 - 0	1:44	IPO
G-46	SARAH Mazouz	4	6	COULOMBE Mina	10 - 0	1:17	IPO
G-54	STOUT Nicole	5	6	COULOMBE Mina	0 - 10	2:26	IPO

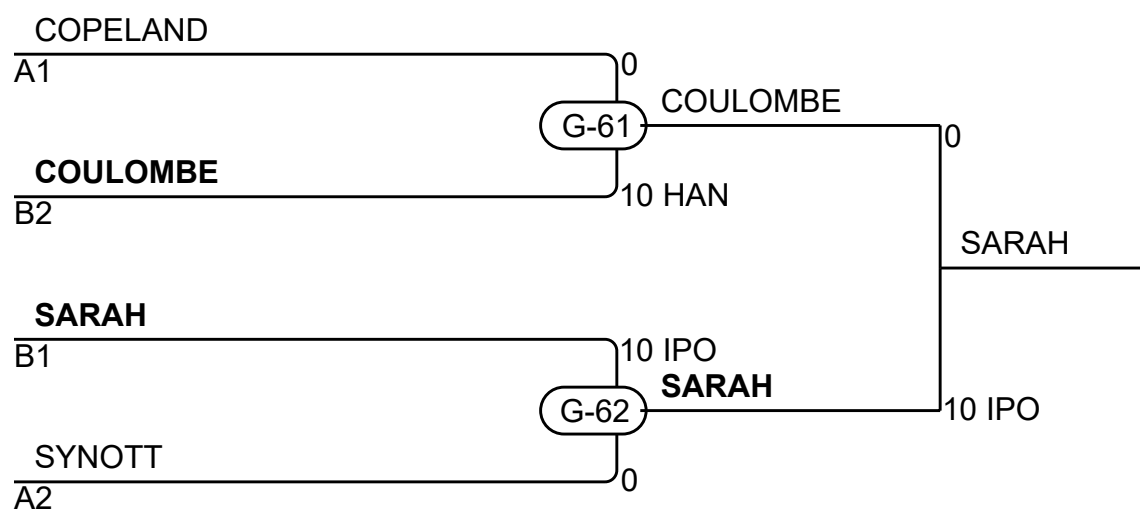

Résultats/Results

Pos	Nom/Name
1	SARAH Mazouz, GBN
2	COULOMBE Mina, QC
3	COPELAND Allayah, ON
3	SYNOTT Josie-Anne, QC

SenM -90

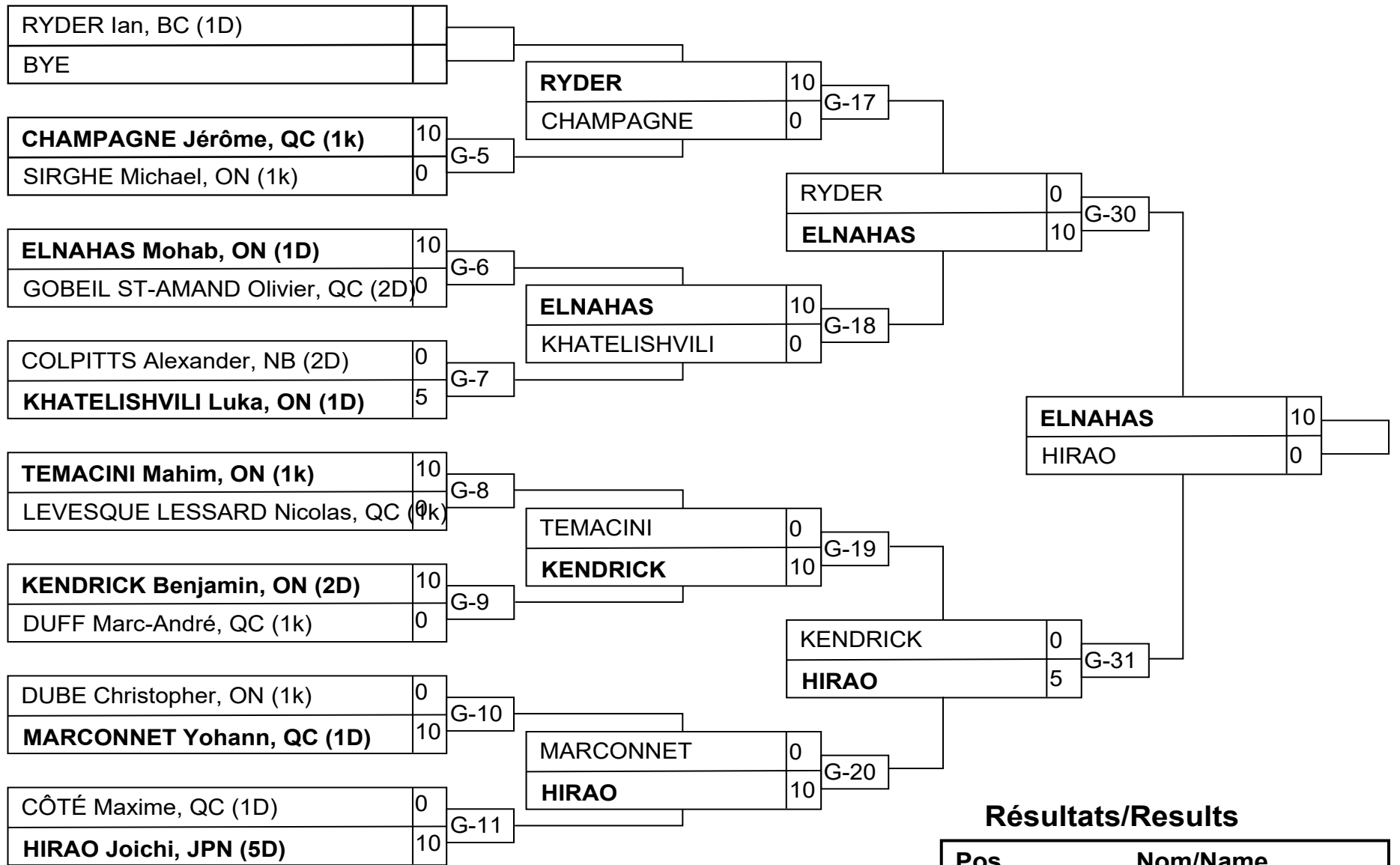

Résultats/Results

Pos	Nom/Name
1	ELNAHAS Mohab, ON (1D)
2	HIRAO Joichi, JPN (5D)
3	RYDER Ian, BC (1D)
3	KENDRICK Benjamin, ON (2D)

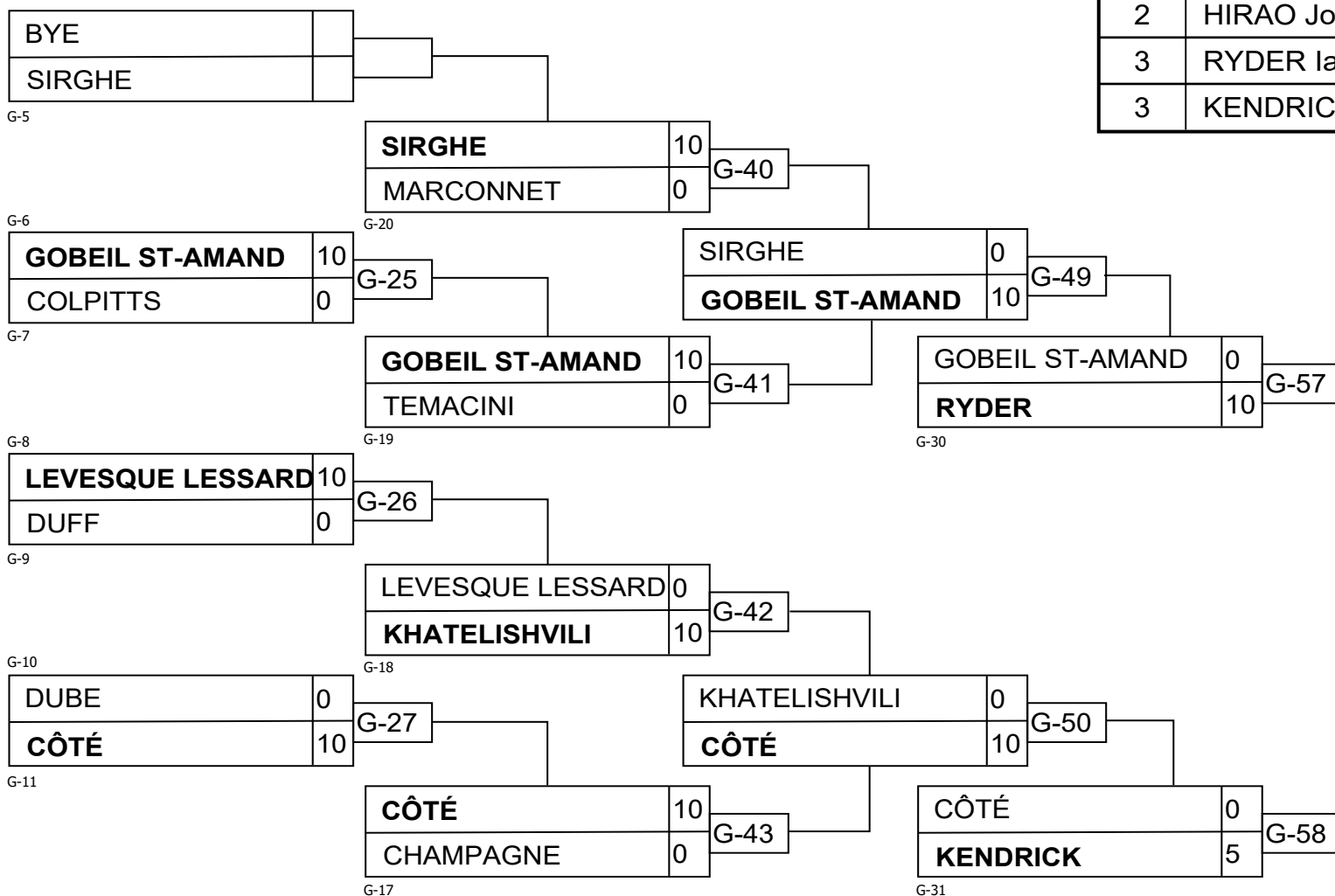

SenM +100

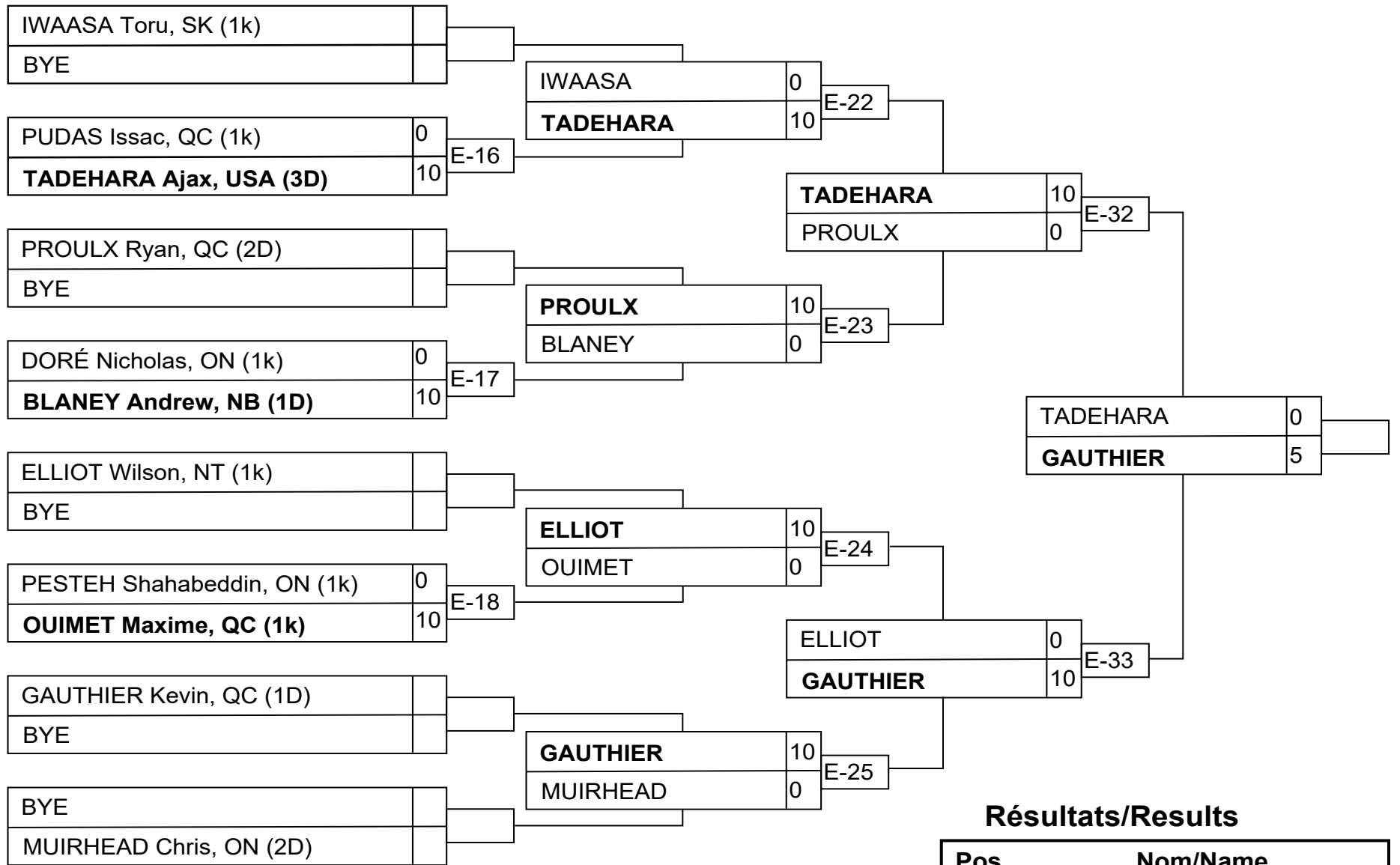

Résultats/Results

Pos	Nom/Name
1	GAUTHIER Kevin, QC (1D)
2	TADEHARA Ajax, USA (3D)
3	PROULX Ryan, QC (2D)
3	ELLIOT Wilson, NT (1k)

