

**HOWARD**

**POWER HARROW**

**HK25 - HK31 - HK32**

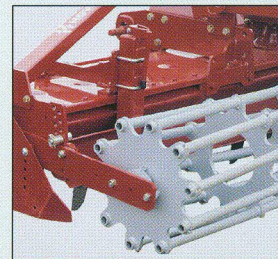

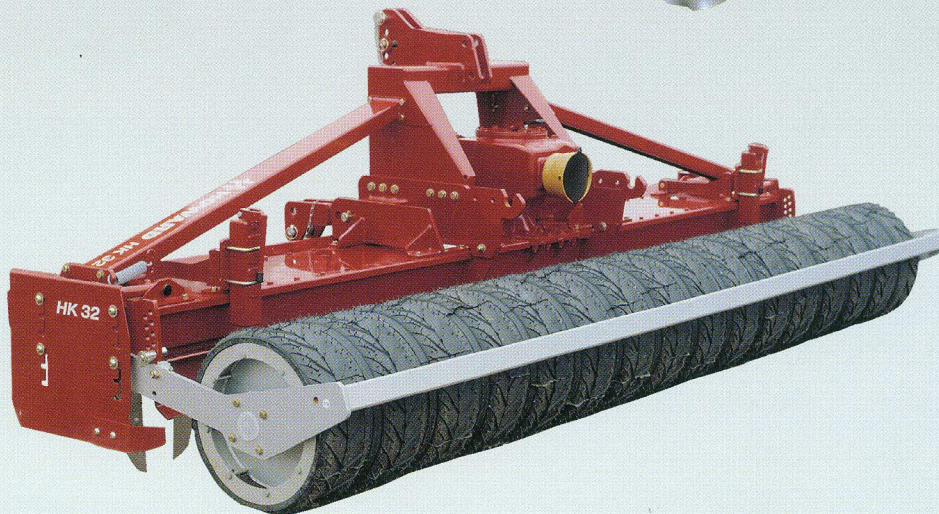
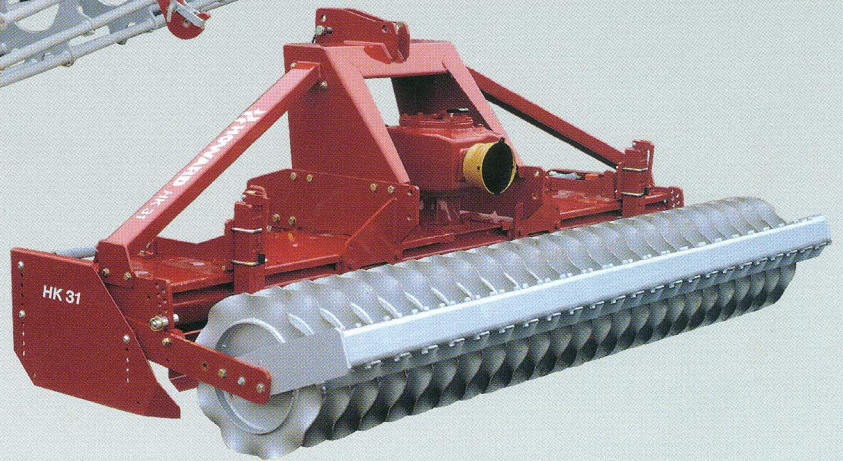
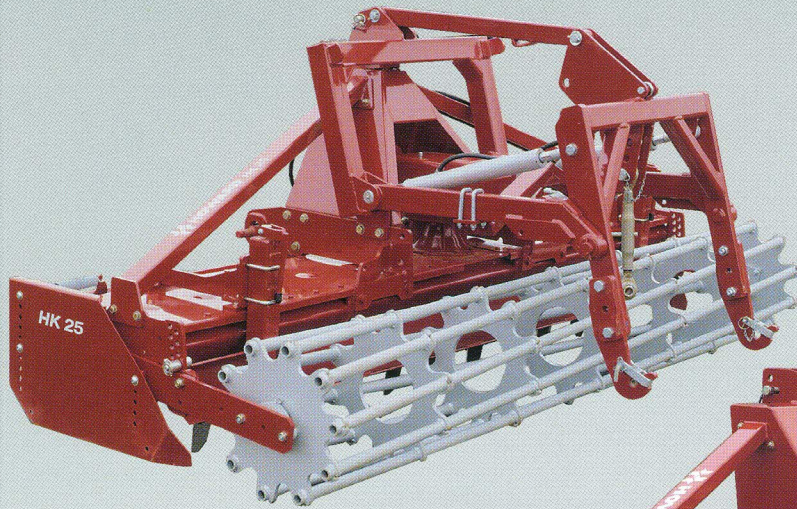

## Power Harrow HK 25

The HK 25 Power Harrow is a Power Harrow for medium size farms to work behind tractors up to 130 hp (95 kW). A machine which has been built in some thousand units has been further developed to meet the wishes of today farmers and to work together optimal with modern tractors and seed drills.

Working widths of 79 in, 99 in and 118 in (2.0 m, 2.5 m and 3.0 m) are ideal to meet the demands of the farmer.

A strong topmast in combination with a floating bottom link mounting fits perfectly to today's tractors and allows the HK 25 to precisely follow the shape of the field.

The HOWARD Selectatilt Gearbox allows PTO speeds of 540, 750 and 1000 RPM and rotor speeds between 195 and 400/min.

Rotor shaft and tine carrier are forged in one piece of high quality steel.

The big sized taper roller bearings in exchangeable housings under the drive gear ensure a long troublefree running. Four rotors per metre working width ensure a top working quality.

The wanted working depth can easily be adjusted by a pin on each side of the machine. This adjustment allows the machine to run over stones without lifting the roller and gives an optimal depth control at the same time.

Different rollers, front and rear levelling bars, different Hitches and many other options are available for the Howard HK 25.

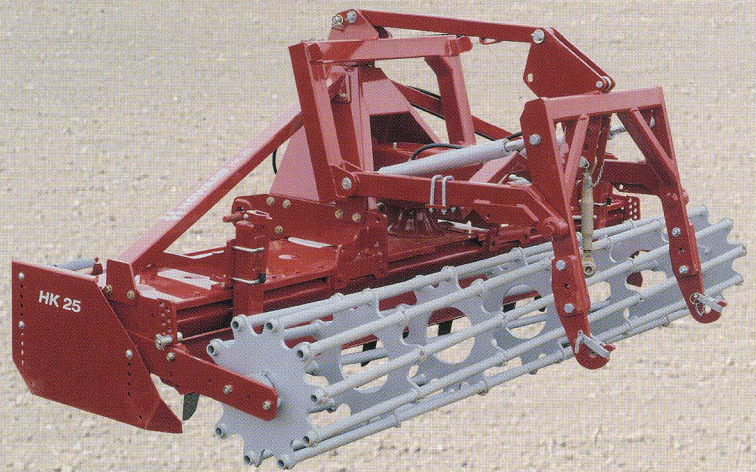

*HK 25 with crumble roller and hydraulic Hitch (optional).*

Type	Working width in (m)	Max. hp (kW)	Weight without roller lbs (kg)	Rotor Speed RPM	
				540 PTO	1000 PTO
HK 25 - 200 W	79 (2.00)	130 (95)	1452 (660)	215/360*	400*
HK 25 - 250 W	99 (2.50)	130 (95)	1826 (830)		
HK 25 - 300 W	118 (3.00)	130 (95)	2057 (935)		

*\* Gears for other rotor speeds available. Rear PTO available as option.*

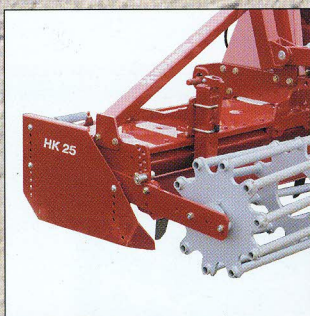

*Depth adjustment and side deflector.*

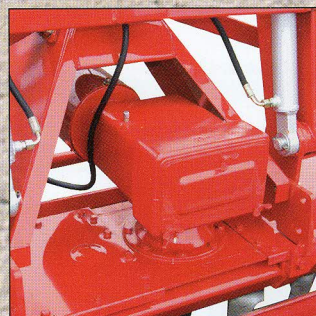

*Selectatilt gearbox.*

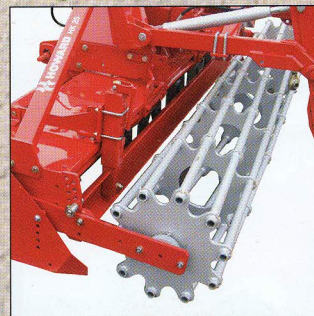

*Levelling bar (optional).*



*Mounting area.*



## Power Harrow HK 31

The HK 31 Power Harrow is a Power Harrow for medium and big size farms to work behind tractors up to 170 hp (125 kW). A machine which is based on Howard's long experience on PTO driven soil working machines to meet the latest demands of farmers and contractors.

HK 31 is available in 118 in, 138 in and 157 in (3.00 m, 3.50 m and 4.00 m) working width.

A strong headstock in combination with the floating bottom link shaft makes the HK 31 an optimal combination with the different tractors and seed drills.

Due to the well proven 3-speed lever change gearbox with rear PTO it is very easy to always run at the optimal rotor speed even in different working conditions.

Rotor shaft and tine carrier are forged in one piece from high quality steel.

The big sized taper roller bearings in exchangeable housings under the drive gear ensure a long troublefree running. Four rotors per metre working width ensure a top working quality.

The wanted working depth can easily be adjusted by a pin on each side of the machine. This adjustment allows the machine to run over stones without lifting the roller and gives an optimal depth control at the same time.

Different rollers, front and rear levelling bars, different Hitches and many other options are available for the Howard HK 31.

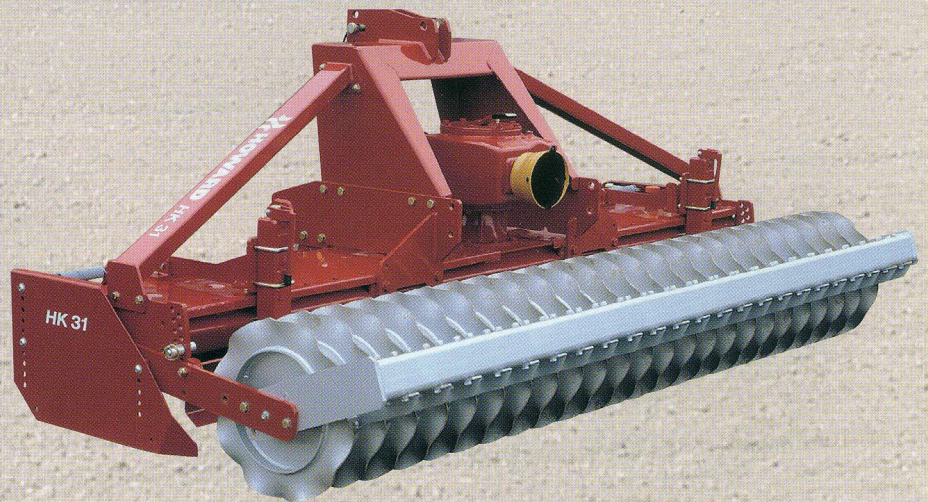
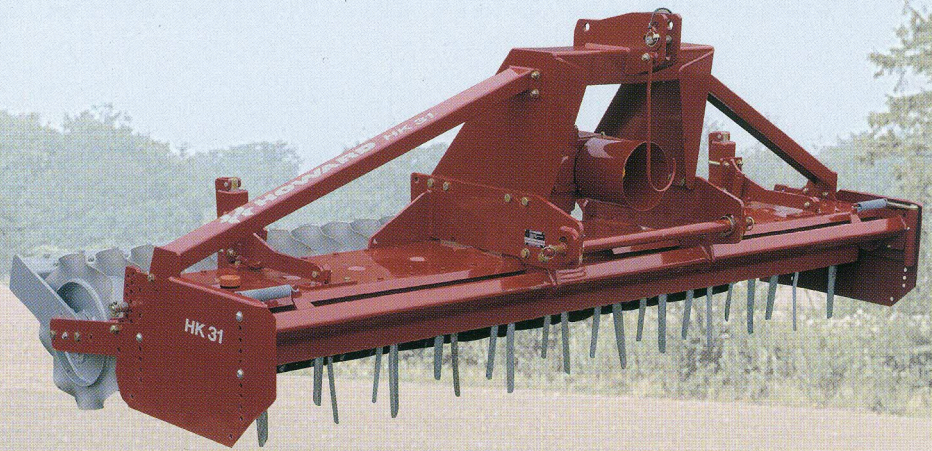

*HK 31 with weavy packer roller.*

Type	Working width in (m)	Max. hp (kW)	Weight without roller lbs (kg)	Rotor Speed RPM 1000 PTO	Number of rotors
HK 31 - 300 D	118 (3.00)	170 (125)	1980 (900)	270/360/400	12
HK 31 - 350 D	138 (3.50)	170 (125)	2167 (985)	270/360/400	14
HK 31 - 400 D	157 (4.00)	170 (125)	2354 (1070)	270/360/400	16



*3-speed leverchange gearbox with rear PTO.*

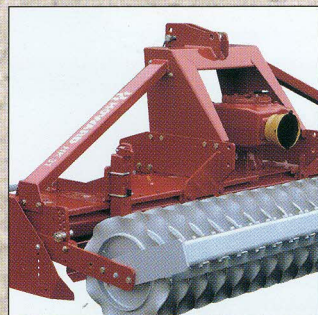

*Depth adjustment.*

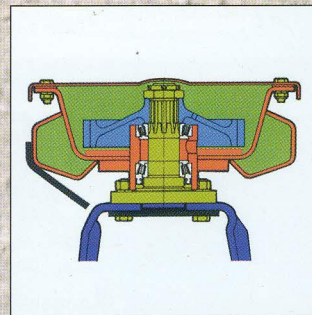

*Frame and rotor unit.*

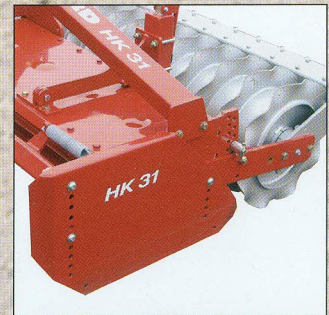

*Side deflector.*



## Power Harrow HK 32

The HK 32 Power Harrow is a Power Harrow for big size farms and contractors to work behind tractors up to 200 hp (150 kW). Based on Howard's more than 20 years experience on Power Harrows the HK 32 represents the top end of today available Power Harrows.

HK 32 is available in 118 in, 138 in and 157 in (3.00 m, 3.50 m and 4.00 m) working width.

The extremely strong frame concept with adjustable, floating bottom link brackets make the HK 32 an optimal combination with the different tractors and seed drills also in difficult working conditions.

Two different leverchange gearboxes with rear PTO are available:

3-speed gearbox - max. 170 hp (125 kW)  
2-speed gearbox - max. 200 hp (150 kW)

Rotor shaft and the round shaped tine carrier are forged in one piece from high quality steel.

The oversized taper roller bearings are fitted in exchangeable 'cartridges' under the drive gear. This special construction ensures a long troublefree life of this Power Harrow. Four rotors per metre working width give a top working quality.

The wanted working depth can easily be adjusted by a pin on each side of the machine. This adjustment allows the machine to run over stones without lifting the roller and gives an optimal depth control at the same time.

Different rollers, front and rear levelling bars, different Hitches and many other options are available for the Howard HK 32.

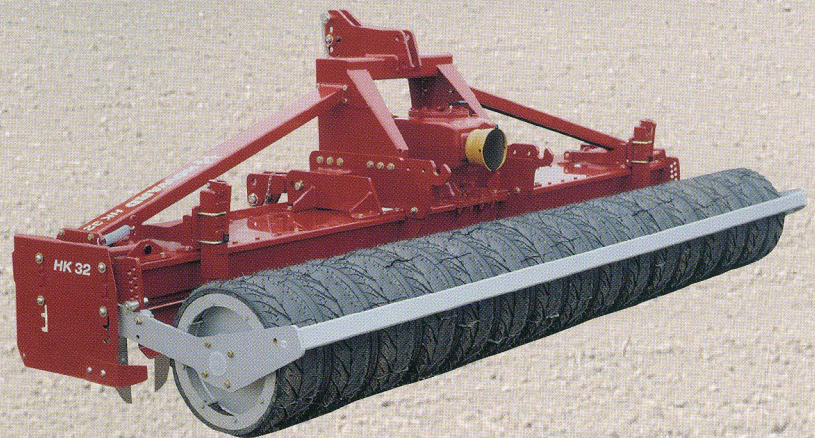
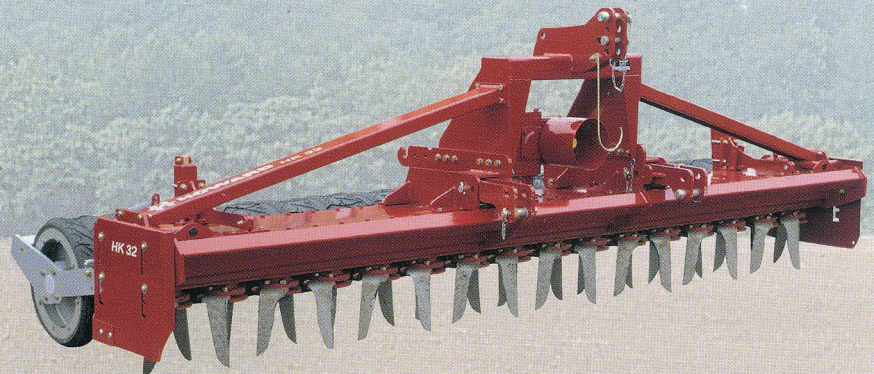

HK 32 with tire roller.

Type	Working width in (m)	Max. hp (kW)	Weight without roller lbs (kg)	Rotor Speed RPM	Number of rotors
HK 32 - 300	118 (3.00)	170 (125)	2282 (1035)	270/360/400	12
HK 32 - 350	138 (3.50)	170 (125)	2535 (1150)		14
HK 32 - 400	157 (4.00)	170 (125)	2712 (1230)		16
HK 32 - 300ZS	118 (3.00)	200 (150)	2348 (1065)	274/318	12
HK 32 - 350ZS	138 (3.50)	200 (150)	2601 (1180)		14
HK 32 - 400ZS	157 (4.00)	200 (150)	2778 (1260)		16

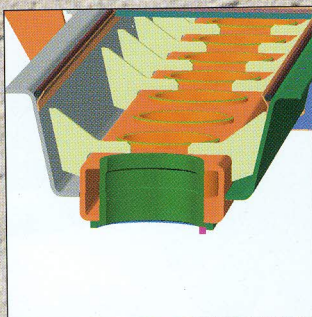

HK 32 frame.

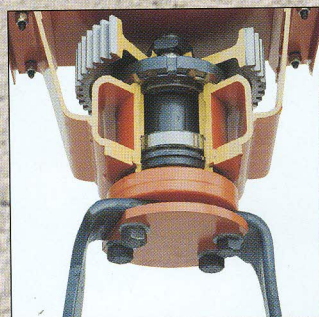

Rotor unit with exchangeable housing.



3-speed leverchange gearbox with rear PTO.



Round Rotors / Tines / Double Flanges (optional).





*HK 31 with Nordsten NS 3130 (with fine seed box).*



*HK 32 with Nordsten NS 4140 and double disc coulters.*



# Rollers to suit all soils and conditions

Ultimate versatility is essential and the wide selection of rear rollers enables the Howard Power Harrows to be perfectly suited to different soils and conditions.

The right choice of roller also enables effective cultivation and drilling when the Howard Power Harrow is used in combination with a seed drill.

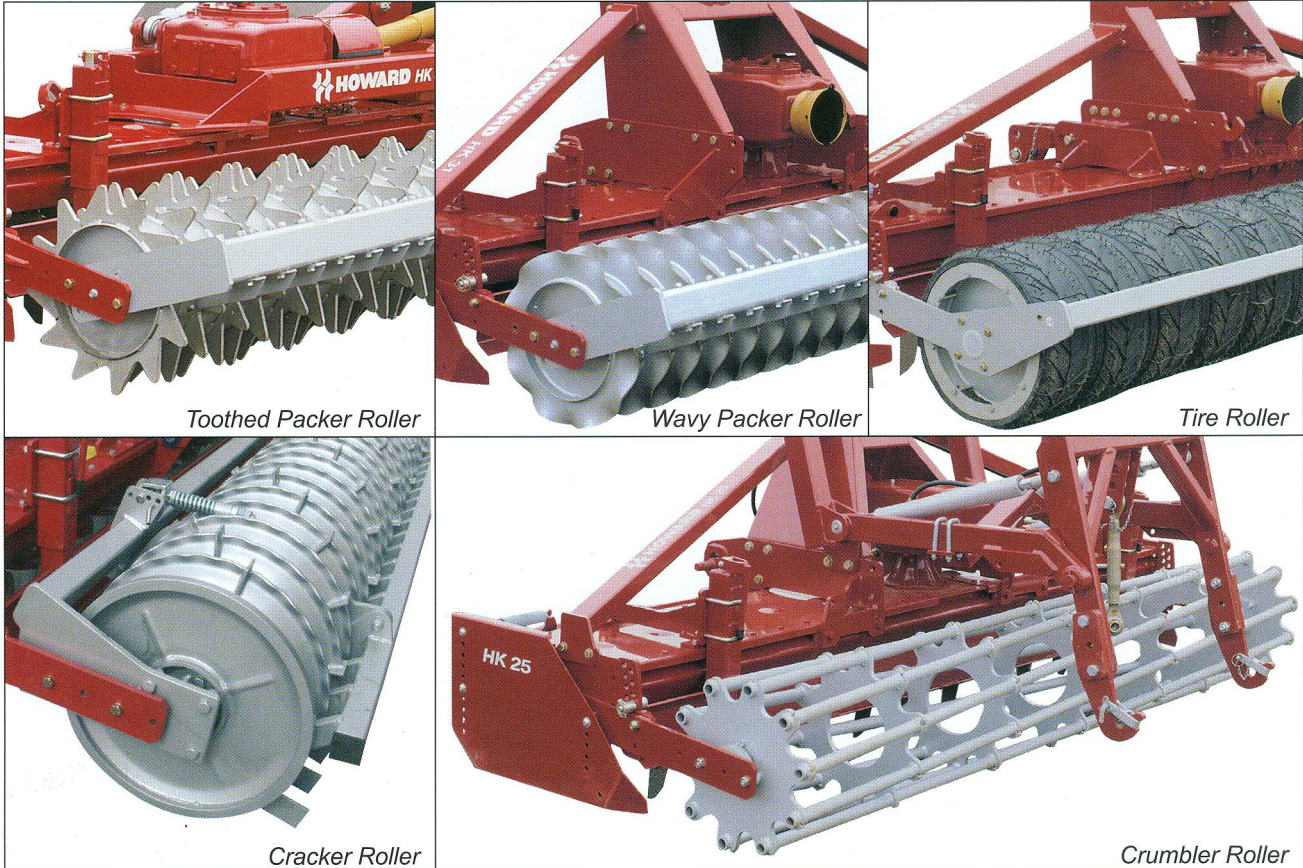

Howard Power Harrow with different rollers.

GUY MACHINERY [guymachinery@yahoo.ca](mailto:guymachinery@yahoo.ca)  
14213 WASHINGTON ST  
WOODSTOCK, IL 60098  
(815) 338-0600 fax (815) 338-2525  
[www.tinedweeder.com](http://www.tinedweeder.com)  
[www.youtube.com/guymachinery](http://www.youtube.com/guymachinery)



**Kongskilde Limited**

710 Wright Street • Strathroy Ontario  
N7G 3H8 • Canada  
Tel.: (519) 245-9917 • Fax: (519) 245-8293  
[mail@kc.kongskilde.com](mailto:mail@kc.kongskilde.com)

**Kongskilde Industries Inc.**

2439 South Main, Unit 2 • Bloomington IL 61704 • USA  
Tel.: (309) 820-1090 • Fax: (309) 820-1364  
[mail@kus.kongskilde.com](mailto:mail@kus.kongskilde.com)  
[www.kongskilde.com](http://www.kongskilde.com)