

2016  
DRAPERY  
HARDWARE  
COLLECTION

[www.selectdraperyhardware.com](http://www.selectdraperyhardware.com)

# TABLE OF CONTENTS



## SELECT COLLECTION

	<b>WHITE (50)</b>
	<b>LINEN (52)</b>
	<b>UNFINISHED (76)</b>
	<b>VINTAGE GOLD (23)</b>
	<b>WALNUT (55)</b>
	<b>MAHOGANY (03)</b>
	<b>BRONZE (17)</b>
	<b>MOCHA (955)</b>
	<b>BLACK WALNUT (47)</b>
	<b>BLACK (45)</b>
	<b>GOLD WITH BLACK WASH (945)</b>
	<b>ANTIQUE PEWTER (965)</b>
	<b>PLATINUM (960)</b>



## SELECT WOOD Collection begins on page 5.

Holdbacks & Medallions .....	7
French Returns .....	9
1 3/8" & 2 1/4" Poles .....	10
1 3/8" & 2 1/4" End Caps .....	11
1 3/8" & 2 1/4" Finials .....	12
1 3/8" & 2 1/4" Wood Brackets ....	21
1 3/8" & 2 1/4" Metal Brackets ....	22
1 3/8" & 2 1/4" Rings .....	23
1 3/8" & 2 1/4" Accessories .....	24
3" Poles .....	25
3" End Caps .....	25
3" Finials .....	26
3" Brackets .....	27
3" Rings & Accessories .....	28

## SELECT *Rustic* ELEGANCE

**Rustic Elegance** Collection begins on page 29.

					
NATURAL (715)	ENGLISH CHESTNUT (725)	PECAN (735)	AMERICAN WALNUT (755)	ESPRESSO (745)	CHARCOAL (40)

1 3/8" & 2 1/4" Finials .....	31
1 3/8" & 2 1/4" End Caps .....	32
Rustic Elegance Finishes .....	33
1 3/8" & 2 1/4" Accessories .....	33
1 3/8" & 2 1/4" Poles .....	33
Iron Image 1 3/8" .....	35



## SELECT TRAVERSE RODS

**Select Traverse Rod** Collection begins on page 37.

Select Premium Traverse Rods .....	39
Select Supreme Traverse Rods .....	39
Flat Fascia Traverse Rods .....	41
Custom Mitered Traverse Rods .....	43
Ordering and Specifications.....	44
1 3/8" & 2 1/4" Pole Combination Brackets ....	45
Bracket Details .....	46

## GENERAL INFORMATION

Ordering Information .....	47
Displays and Sales Aids .....	48

The color photos in this brochure are a close representation of the finishes available. Please refer to your Select Binder #2016SWB, Select Color Selector #2016SEL, or Select Rustic Elegance Selector #2013SRE for actual finish samples.



# SELECT WOOD COLLECTION

The Select Collection offers a choice of thirteen stunning finishes for poles, traverse rods, brackets, finials, and rings. This collection provides a variety of beautiful drapery hardware and accessories of superior quality with lustrous finishes and amazing detail at prices that cannot compare.

**SELECT WOOD** Collection may be viewed on pages 5 to 28.



# SELECT *Rustic* ELEGANCE

DEFINING

# Elegance

Select Rustic Elegance drapery hardware features five finishes that showcase the beauty of the wood grain and decorative textures characteristic to Ash wood.

Included in the Rustic Elegance Collection is the specialty line, **Iron Image**. Iron Image offers the look of traditional wrought iron in 1 3/8" diameter wood poles, traverse rods, and finials. The matte, charcoal finish gives the four finial designs and wood poles the look of forged iron. Authentic iron rings and brackets complete the collection.

The **Rustic Elegance** Collection may be viewed on pages 29 to 36.





## SELECT TRAVERSE RODS

Select Traverse Rods feature heavy duty tracks that are constructed with wheeled carriers and metal masters with the capacity to handle today's drapery treatments made with blackout linings and interlinings.

Select Wood Traverse Rods are available in all Select Wood and Rustic Elegance finishes. 2 1/4" and 3" Traverse Rods are available with the patented Select SureLock® Traverse Ring System. The SureLock Rings® perfectly match the Select full round rings.

The **Select Traverse Rod** Collection may be viewed on pages 37 to 46.









# HOLDBACKS & MEDALLIONS

54-784 NEWPORT Resin 3 3/4" Sq.	53-734 OMNI Wood 4" Dia.	53-714 SATURN Wood 3 3/4" Dia.	54-724 LAUREL Resin 3 3/4" Dia.	54-782 PETITE NEWPORT Resin 2 3/4" Sq.	53-732 PETITE OMNI Wood 3" Dia.	53-712 PETITE SATURN Wood 2 3/4" Dia.	54-722 PETITE LAUREL Resin 2 3/4" Dia.	
								WHITE (50)
								LINEN (52)
								VINTAGE GOLD (23)
								WALNUT (55)
								MAHOGANY (03)
								BRONZE (17)
								MOCHA (955)
								BLACK WALNUT (47)
								BLACK ( 45)
								GOLD WITH BLACK WASH (945)
								PLATINUM (960)
								ANTIQUE PEWTER (965)



# HOLDBACKS & MEDALLIONS



- Eight Holdback styles
- Twelve finishes plus unfinished
- Adjustable wood spindles
- Packaged in pairs

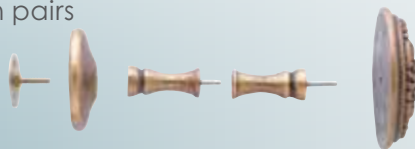

Holdback Side View  
2" or 4" spindle projection.

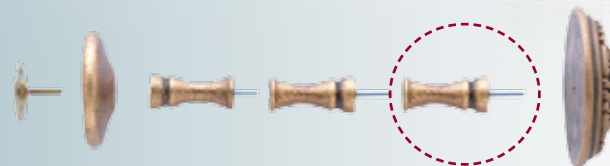

Holdback Side View  
2", 4" or 6" spindle projection.



Shown with 53-002 for  
additional 2" projection.  
(Sold Separately)

# FRENCH RETURNS

**Select French Returns** are offered in the 1 3/8" Collection in three wood finishes; Black, Bronze, and Black Walnut. The soft curved return is constructed using a combination of wood and metal for support. Select metal bracket, 10-203 or 10-283, are recommended to use as a center support for all installations. 1 3/8" wood poles and rings are sold separately.



13-463-17  
Bronze Wood Fascia Finish  
with Bronze Metal Return



13-463-45  
Black Wood Fascia Finish  
with Black Metal Return



13-463-47  
Black Walnut Wood Fascia  
Finish with Bronze Metal Return



**Metal Center Support Bracket**  
10-283



**Metal Bracket**  
10-203

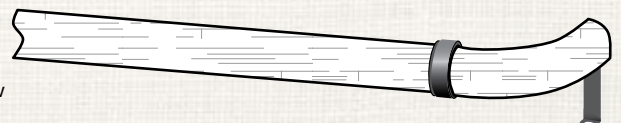
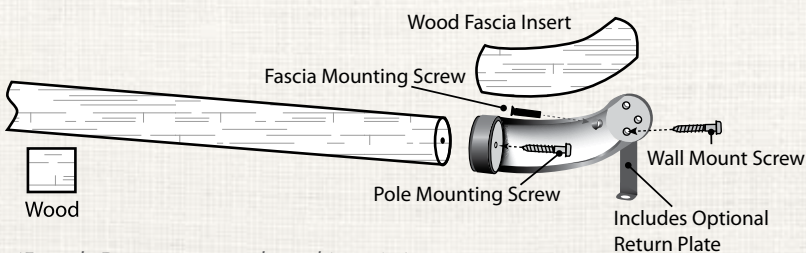

Return - 3 1/2"  
Projection - 4 1/4"  
Length - 3 1/4"

*(French Returns are packaged in pairs)*

# 1 3/8" & 2 1/4" SELECT POLES



White (50) – Reeded Pole  
White (50) – Smooth Pole



Walnut (55) – Reeded Pole  
Walnut (55) – Smooth Pole



Black Walnut (47) – Reeded Pole  
Black Walnut (47) – Smooth Pole



Linen (52) – Reeded Pole  
Linen (52) – Smooth Pole



Mahogany (03) – Reeded Pole  
Mahogany (03) – Smooth Pole



Black (45) – Reeded Pole  
Black (45) – Smooth Pole



Unfinished (76) – Reeded Pole  
Unfinished (76) – Smooth Pole



Bronze (17) – Reeded Pole  
Bronze (17) – Smooth Pole



Platinum (960) – Reeded Pole  
Platinum (960) – Smooth Pole



Vintage Gold (23) – Reeded Pole  
Vintage Gold (23) – Smooth Pole



Mocha (955) – Reeded Pole  
Mocha (955) – Smooth Pole

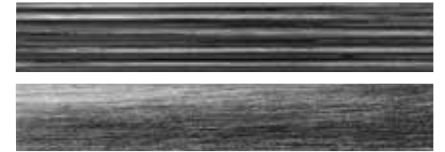

Antique Pewter (965) – Reeded Pole  
Antique Pewter (965) – Smooth Pole

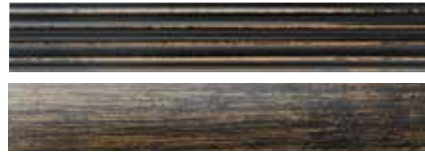

Gold with Black Wash (945) – Reeded Pole  
Gold with Black Wash (945) – Smooth Pole

## Select Smooth & Reeded Poles

Description	4'	6'	8'	12'	16'
1 3/8" Smooth Pole	11-004	11-006	11-008	11-012	-
1 3/8" Reeded Pole	12-004	12-006	12-008	12-012	-
2 1/4" Smooth Pole	21-004	21-006	21-008	21-012	21-016
2 1/4" Reeded Pole	22-004	22-006	22-008	22-012	22-016



# 1 3/8" & 2 1/4" END CAPS

Select 1 3/8" & 2 1/4" End Caps are packaged in pairs.

## WOOD END CAP

1 3/8" - 7/8" L X 1 7/8" H  
2 1/4" - 1 3/8" L X 3" H



**WHITE**  
13-140-50 (1 3/8")  
23-140-50 (2 1/4")



**LINEN**  
13-140-52 (1 3/8")  
23-140-52 (2 1/4")



**VINTAGE GOLD**  
13-140-23 (1 3/8")  
23-140-23 (2 1/4")



**WALNUT**  
13-140-55 (1 3/8")  
23-140-55 (2 1/4")



**MAHOGANY**  
13-140-03 (1 3/8")  
23-140-03 (2 1/4")



**BRONZE**  
13-140-17 (1 3/8")  
23-140-17 (2 1/4")



**MOCHA**  
13-140-955 (1 3/8")  
23-140-955 (2 1/4")



**BLACK WALNUT**  
13-140-47 (1 3/8")  
23-140-47 (2 1/4")



**BLACK**  
13-140-45 (1 3/8")  
23-140-45 (2 1/4")



**GOLD WITH BLACK WASH**  
13-140-945 (1 3/8")  
23-140-945 (2 1/4")



**PLATINUM**  
13-140-960 (1 3/8")  
23-140-960 (2 1/4")



**ANTIQUPE WTEW**  
13-140-965 (1 3/8")  
23-140-965 (2 1/4")

## VESTA WOOD END CAP

1 3/8" - 1 3/4" L X 2 3/8" H  
2 1/4" - 2" L X 3 3/8" H



**WHITE**  
13-145-50 (1 3/8")  
23-145-50 (2 1/4")

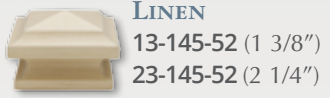

**LINEN**  
13-145-52 (1 3/8")  
23-145-52 (2 1/4")



**VINTAGE GOLD**  
13-145-23 (1 3/8")  
23-145-23 (2 1/4")

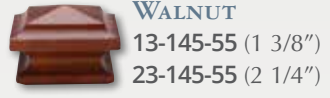

**WALNUT**  
13-145-55 (1 3/8")  
23-145-55 (2 1/4")



**MAHOGANY**  
13-145-03 (1 3/8")  
23-145-03 (2 1/4")

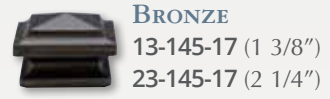

**BRONZE**  
13-145-17 (1 3/8")  
23-145-17 (2 1/4")



**MOCHA**  
13-145-955 (1 3/8")  
23-145-955 (2 1/4")

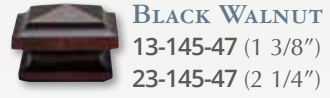

**BLACK WALNUT**  
13-145-47 (1 3/8")  
23-145-47 (2 1/4")



**BLACK**  
13-145-45 (1 3/8")  
23-145-45 (2 1/4")



**GOLD WITH BLACK WASH**  
13-145-945 (1 3/8")  
23-145-945 (2 1/4")



**PLATINUM**  
13-145-960 (1 3/8")  
23-145-960 (2 1/4")



**ANTIQUPE WTEW**  
13-145-965 (1 3/8")  
23-145-965 (2 1/4")

## ARIES WOOD END CAP

1 3/8" - 1 1/2" L X 2 5/8" H  
2 1/4" - 2" L X 3 1/4" H



**WHITE**  
13-143-50 (1 3/8")  
23-143-50 (2 1/4")



**LINEN**  
13-143-52 (1 3/8")  
23-143-52 (2 1/4")



**VINTAGE GOLD**  
13-143-23 (1 3/8")  
23-143-23 (2 1/4")

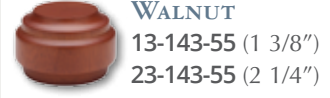

**WALNUT**  
13-143-55 (1 3/8")  
23-143-55 (2 1/4")



**MAHOGANY**  
13-143-03 (1 3/8")  
23-143-03 (2 1/4")



**BRONZE**  
13-143-17 (1 3/8")  
23-143-17 (2 1/4")



**MOCHA**  
13-143-955 (1 3/8")  
23-143-955 (2 1/4")



**BLACK WALNUT**  
13-143-47 (1 3/8")  
23-143-47 (2 1/4")



**BLACK**  
13-143-45 (1 3/8")  
23-143-45 (2 1/4")



**GOLD WITH BLACK WASH**  
13-143-945 (1 3/8")  
23-143-945 (2 1/4")



**PLATINUM**  
13-143-960 (1 3/8")  
23-143-960 (2 1/4")



**ANTIQUPE WTEW**  
13-143-965 (1 3/8")  
23-143-965 (2 1/4")

## BRADFORD RESIN END CAP

1 3/8" - 7/8" L X 1 7/8" H  
2 1/4" - 1 3/8" L X 3" H



**WHITE**  
14-144-50 (1 3/8")  
24-144-50 (2 1/4")



**LINEN**  
14-144-52 (1 3/8")  
24-144-52 (2 1/4")



**VINTAGE GOLD**  
14-144-23 (1 3/8")  
24-144-23 (2 1/4")



**WALNUT**  
14-144-55 (1 3/8")  
24-144-55 (2 1/4")



**MAHOGANY**  
14-144-03 (1 3/8")  
24-144-03 (2 1/4")



**BRONZE**  
14-144-17 (1 3/8")  
24-144-17 (2 1/4")



**MOCHA**  
14-144-955 (1 3/8")  
24-144-955 (2 1/4")



**BLACK WALNUT**  
14-144-47 (1 3/8")  
24-144-47 (2 1/4")



**BLACK**  
14-144-45 (1 3/8")  
24-144-45 (2 1/4")



**GOLD WITH BLACK WASH**  
14-144-945 (1 3/8")  
24-144-945 (2 1/4")



**PLATINUM**  
14-144-960 (1 3/8")  
24-144-960 (2 1/4")



**ANTIQUPE WTEW**  
14-144-965 (1 3/8")  
24-144-965 (2 1/4")

# 1 3/8" & 2 1/4" FINIALS



Select 1 3/8" Finials are packaged in pairs. Select 2 1/4" Finials are packaged as each.

## IMPERIAL FINIAL - Resin

1 3/8" - 3 5/8" L X 2 3/4" H

2 1/4" - 5 1/2" L X 4 1/4" H



### LINEN

14-151-52 (1 3/8")

24-151-52 (2 1/4")



### VINTAGE GOLD

14-151-23 (1 3/8")

24-151-23 (2 1/4")



### WALNUT

14-151-55 (1 3/8")

24-151-55 (2 1/4")



### MAHOGANY

14-151-03 (1 3/8")

24-151-03 (2 1/4")



### BRONZE

14-151-17 (1 3/8")

24-151-17 (2 1/4")



### MOCHA

14-151-955 (1 3/8")

24-151-955 (2 1/4")



### BLACK WALNUT

14-151-47 (1 3/8")

24-151-47 (2 1/4")



### GOLD WITH BLACK WASH

14-151-945 (1 3/8")

24-151-945 (2 1/4")



### PLATINUM

14-151-960 (1 3/8")

24-151-960 (2 1/4")



### ANTIQUE PEWTER

14-151-965 (1 3/8")

24-151-965 (2 1/4")

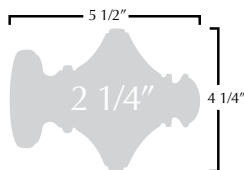
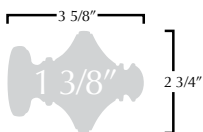

## LIBERTY FINIAL - Resin

1 3/8" - 4 5/8" L X 2 5/8" H

2 1/4" - 6 1/2" L X 3 5/8" H



### LINEN

14-127-52 (1 3/8")

24-127-52 (2 1/4")



### VINTAGE GOLD

14-127-23 (1 3/8")

24-127-23 (2 1/4")



### WALNUT

14-127-55 (1 3/8")

24-127-55 (2 1/4")



### MAHOGANY

14-127-03 (1 3/8")

24-127-03 (2 1/4")



### BRONZE

14-127-17 (1 3/8")

24-127-17 (2 1/4")



### MOCHA

14-127-955 (1 3/8")

24-127-955 (2 1/4")



### BLACK WALNUT

14-127-47 (1 3/8")

24-127-47 (2 1/4")



### GOLD WITH BLACK WASH

14-127-945 (1 3/8")

24-127-945 (2 1/4")



### PLATINUM

14-127-960 (1 3/8")

24-127-960 (2 1/4")



### ANTIQUE PEWTER

14-127-965 (1 3/8")

24-127-965 (2 1/4")





# 1 3/8" & 2 1/4" FINIALS

Select 1 3/8" Finials are packaged in pairs. Select 2 1/4" Finials are packaged as each.

## NEWPORT FINIAL - Resin

1 3/8" - 4 1/2" L X 3 3/8" H

2 1/4" - 6" L X 4 3/8" H



**LINEN**

14-128-52 (1 3/8")

24-128-52 (2 1/4")



**VINTAGE GOLD**

14-128-23 (1 3/8")

24-128-23 (2 1/4")



**WALNUT**

14-128-55 (1 3/8")

24-128-55 (2 1/4")



**MAHOGANY**

14-128-03 (1 3/8")

24-128-03 (2 1/4")

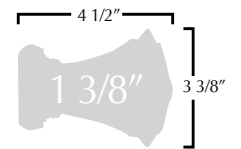

**BRONZE**

14-128-17 (1 3/8")

24-128-17 (2 1/4")

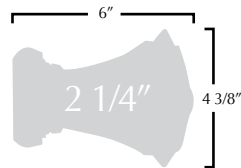

**MOCHA**

14-128-955 (1 3/8")

24-128-955 (2 1/4")



**BLACK WALNUT**

14-128-47 (1 3/8")

24-128-47 (2 1/4")



**GOLD WITH BLACK WASH**

14-128-945 (1 3/8")

24-128-945 (2 1/4")



**PLATINUM**

14-128-960 (1 3/8")

24-128-960 (2 1/4")



**ANTIQUE PEWTER**

14-128-965 (1 3/8")

24-128-965 (2 1/4")

## VALENCIA FINIAL - Resin

1 3/8" - 4 3/8" L X 2 1/2" H

2 1/4" - 5 3/4" L X 3 3/8" H



**LINEN**

14-126-52 (1 3/8")

24-126-52 (2 1/4")



**VINTAGE GOLD**

14-126-23 (1 3/8")

24-126-23 (2 1/4")



**WALNUT**

14-126-55 (1 3/8")

24-126-55 (2 1/4")



**MAHOGANY**

14-126-03 (1 3/8")

24-126-03 (2 1/4")

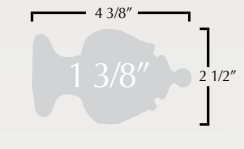

**BRONZE**

14-126-17 (1 3/8")

24-126-17 (2 1/4")

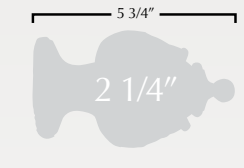

**MOCHA**

14-126-955 (1 3/8")

24-126-955 (2 1/4")



**BLACK WALNUT**

14-126-47 (1 3/8")

24-126-47 (2 1/4")



**GOLD WITH BLACK WASH**

14-126-945 (1 3/8")

24-126-945 (2 1/4")



**PLATINUM**

14-126-960 (1 3/8")

24-126-960 (2 1/4")



**ANTIQUE PEWTER**

14-126-965 (1 3/8")

24-126-965 (2 1/4")

# 1 3/8" & 2 1/4" FINIALS



Select 1 3/8" Finials are packaged in pairs. Select 2 1/4" Finials are packaged as each.

## PINECONE FINIAL - Resin

1 3/8" - 4 1/2" L X 2 3/8" H  
2 1/4" - 6 1/4" L X 3 1/2" H



**LINEN**  
14-115-52 (1 3/8")  
24-115-52 (2 1/4")



**VINTAGE GOLD**  
14-115-23 (1 3/8")  
24-115-23 (2 1/4")



**WALNUT**  
14-115-55 (1 3/8")  
24-115-55 (2 1/4")

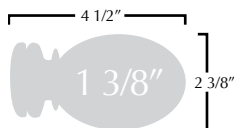

**MAHOGANY**  
14-115-03 (1 3/8")  
24-115-03 (2 1/4")

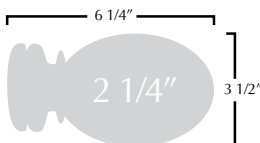

**BRONZE**  
14-115-17 (1 3/8")  
24-115-17 (2 1/4")



**MOCHA**  
14-115-955 (1 3/8")  
24-115-955 (2 1/4")



**BLACK WALNUT**  
14-115-47 (1 3/8")  
24-115-47 (2 1/4")



**GOLD WITH BLACK WASH**  
14-115-945 (1 3/8")  
24-115-945 (2 1/4")



**PLATINUM**  
14-115-960 (1 3/8")  
24-115-960 (2 1/4")



**ANTIQUE PEWTER**  
14-115-965 (1 3/8")  
24-115-965 (2 1/4")



**WHITE**  
13-105-50 (1 3/8")  
23-105-50 (2 1/4")



**LINEN**  
13-105-52 (1 3/8")  
23-105-52 (2 1/4")



**VINTAGE GOLD**  
13-105-23 (1 3/8")  
23-105-23 (2 1/4")



**WALNUT**  
13-105-55 (1 3/8")  
23-105-55 (2 1/4")



**MAHOGANY**  
13-105-03 (1 3/8")  
23-105-03 (2 1/4")



**BRONZE**  
13-105-17 (1 3/8")  
23-105-17 (2 1/4")



**MOCHA**  
13-105-955 (1 3/8")  
23-105-955 (2 1/4")



**BLACK WALNUT**  
13-105-47 (1 3/8")  
23-105-47 (2 1/4")



**BLACK**  
13-105-45 (1 3/8")  
23-105-45 (2 1/4")



**GOLD WITH BLACK WASH**  
13-105-945 (1 3/8")  
23-105-945 (2 1/4")



**PLATINUM**  
13-105-960 (1 3/8")  
23-105-960 (2 1/4")



**ANTIQUE PEWTER**  
13-105-965 (1 3/8")  
23-105-965 (2 1/4")

## PRESCOTT FINIAL Wood

1 3/8" - 3 1/2" L X 3" H  
2 1/4" - 5" L X 4" H



All finials are available in Unfinished (76).



# 1 3/8" & 2 1/4" FINIALS

Select 1 3/8" Finials are packaged in pairs. Select 2 1/4" Finials are packaged as each.

**NOBEL FINIAL**  
Wood  
1 3/8"  
4" L X 2 7/8" H  
2 1/4"  
5 1/2" L X 3 3/4" H

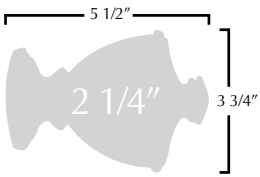
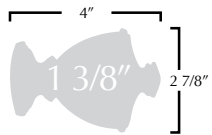

**WHITE**  
13-157-50 (1 3/8")  
23-157-50 (2 1/4")



**LINEN**  
13-157-52 (1 3/8")  
23-157-52 (2 1/4")



**VINTAGE GOLD**  
13-157-23 (1 3/8")  
23-157-23 (2 1/4")



**WALNUT**  
13-157-55 (1 3/8")  
23-157-55 (2 1/4")

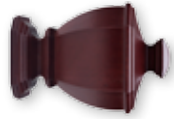

**MAHOGANY**  
13-157-03 (1 3/8")  
23-157-03 (2 1/4")



**BRONZE**  
13-157-17 (1 3/8")  
23-157-17 (2 1/4")



**MOCHA**  
13-157-955 (1 3/8")  
23-157-955 (2 1/4")



**BLACK WALNUT**  
13-157-47 (1 3/8")  
23-157-47 (2 1/4")



**BLACK**  
13-157-45 (1 3/8")  
23-157-45 (2 1/4")



**GOLD WITH BLACK WASH**  
13-157-945 (1 3/8")  
23-157-945 (2 1/4")



**PLATINUM**  
13-157-960 (1 3/8")  
23-157-960 (2 1/4")



**ANTIQUE PEWTER**  
13-157-965 (1 3/8")  
23-157-965 (2 1/4")

**BALL FINIAL**  
Wood  
1 3/8"  
3 3/8" L X 2 3/8" H  
2 1/4"  
5" L X 3 5/8" H

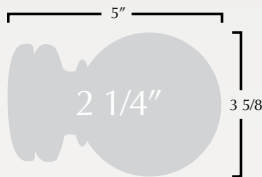
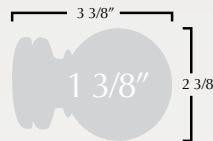

**WHITE**  
13-101-50 (1 3/8")  
23-101-50 (2 1/4")



**LINEN**  
13-101-52 (1 3/8")  
23-101-52 (2 1/4")



**VINTAGE GOLD**  
13-101-23 (1 3/8")  
23-101-23 (2 1/4")



**WALNUT**  
13-101-55 (1 3/8")  
23-101-55 (2 1/4")



**MAHOGANY**  
13-101-03 (1 3/8")  
23-101-03 (2 1/4")



**BRONZE**  
13-101-17 (1 3/8")  
23-101-17 (2 1/4")



**MOCHA**  
13-101-955 (1 3/8")  
23-101-955 (2 1/4")



**BLACK WALNUT**  
13-101-47 (1 3/8")  
23-101-47 (2 1/4")



**BLACK**  
13-101-45 (1 3/8")  
23-101-45 (2 1/4")



**GOLD WITH BLACK WASH**  
13-101-945 (1 3/8")  
23-101-945 (2 1/4")



**PLATINUM**  
13-101-960 (1 3/8")  
23-101-960 (2 1/4")



**ANTIQUE PEWTER**  
13-101-965 (1 3/8")  
23-101-965 (2 1/4")



# 1 3/8" & 2 1/4" FINIALS



Select 1 3/8" Finials are packaged in pairs. Select 2 1/4" Finials are packaged as each.

## REEDED BALL FINIAL - Wood

1 3/8"  
4" L X 2 3/4" H  
2 1/4"  
5 3/8" L X 3 3/8" H

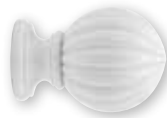
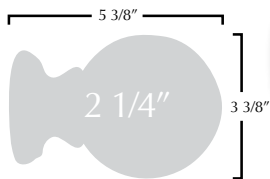
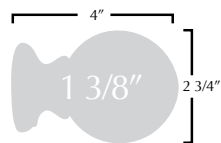

**WHITE**  
13-108-50 (1 3/8")  
23-108-50 (2 1/4")



**LINEN**  
13-108-52 (1 3/8")  
23-108-52 (2 1/4")

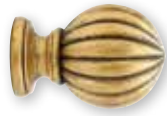

**VINTAGE GOLD**  
13-108-23 (1 3/8")  
23-108-23 (2 1/4")



**WALNUT**  
13-108-55 (1 3/8")  
23-108-55 (2 1/4")



**MAHOGANY**  
13-108-03 (1 3/8")  
23-108-03 (2 1/4")



**BRONZE**  
13-108-17 (1 3/8")  
23-108-17 (2 1/4")



**MOCHA**  
13-108-955 (1 3/8")  
23-108-955 (2 1/4")



**BLACK WALNUT**  
13-108-47 (1 3/8")  
23-108-47 (2 1/4")



**BLACK**  
13-108-45 (1 3/8")  
23-108-45 (2 1/4")



**GOLD WITH BLACK WASH**  
13-108-945 (1 3/8")  
23-108-945 (2 1/4")



**PLATINUM**  
13-108-960 (1 3/8")  
23-108-960 (2 1/4")



**ANTIQUE PEWTER**  
13-108-965 (1 3/8")  
23-108-965 (2 1/4")

## ACORN FINIAL

Wood  
1 3/8"  
3 7/8" L X 2 3/4" H  
2 1/4"  
5 3/8" L X 3 3/4" H

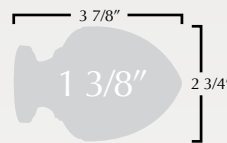

**WHITE**  
13-131-50 (1 3/8")  
23-131-50 (2 1/4")



**LINEN**  
13-131-52 (1 3/8")  
23-131-52 (2 1/4")



**VINTAGE GOLD**  
13-131-23 (1 3/8")  
23-131-23 (2 1/4")



**WALNUT**  
13-131-55 (1 3/8")  
23-131-55 (2 1/4")



**MAHOGANY**  
13-131-03 (1 3/8")  
23-131-03 (2 1/4")



**BRONZE**  
13-131-17 (1 3/8")  
23-131-17 (2 1/4")



**MOCHA**  
13-131-955 (1 3/8")  
23-131-955 (2 1/4")



**BLACK WALNUT**  
13-131-47 (1 3/8")  
23-131-47 (2 1/4")



**BLACK**  
13-131-45 (1 3/8")  
23-131-45 (2 1/4")



**GOLD WITH BLACK WASH**  
13-131-945 (1 3/8")  
23-131-945 (2 1/4")



**PLATINUM**  
13-131-960 (1 3/8")  
23-131-960 (2 1/4")



**ANTIQUE PEWTER**  
13-131-965 (1 3/8")  
23-131-965 (2 1/4")

All finials are available in Unfinished (76).



# 1 3/8" & 2 1/4" FINIALS

Select 1 3/8" Finials are packaged in pairs. Select 2 1/4" Finials are packaged as each.

## WESTWOOD FINIAL - Wood 1 3/8"

3 1/2" L X 2 3/4" H  
2 1/4"  
4 3/4" L X 3 3/4" H



**WHITE**  
13-138-50 (1 3/8")  
23-138-50 (2 1/4")



**LINEN**  
13-138-52 (1 3/8")  
23-138-52 (2 1/4")



**VINTAGE GOLD**  
13-138-23 (1 3/8")  
23-138-23 (2 1/4")



**WALNUT**  
13-138-55 (1 3/8")  
23-138-55 (2 1/4")



**MAHOGANY**  
13-138-03 (1 3/8")  
23-138-03 (2 1/4")



**BRONZE**  
13-138-17 (1 3/8")  
23-138-17 (2 1/4")



**MOCHA**  
13-138-955 (1 3/8")  
23-138-955 (2 1/4")



**BLACK WALNUT**  
13-138-47 (1 3/8")  
23-138-47 (2 1/4")



**BLACK**  
13-138-45 (1 3/8")  
23-138-45 (2 1/4")



**GOLD WITH  
BLACK WASH**  
13-138-945 (1 3/8")  
23-138-945 (2 1/4")



**PLATINUM**  
13-138-960 (1 3/8")  
23-138-960 (2 1/4")



**ANTIQUE PEWTER**  
13-138-965 (1 3/8")  
23-138-965 (2 1/4")

## CROWN FINIAL Wood 1 3/8"

4 1/2" L X 2 3/4" H  
2 1/4"  
5 7/8" L X 3 5/8" H



**WHITE**  
13-134-50 (1 3/8")  
23-134-50 (2 1/4")



**LINEN**  
13-134-52 (1 3/8")  
23-134-52 (2 1/4")



**VINTAGE GOLD**  
13-134-23 (1 3/8")  
23-134-23 (2 1/4")



**WALNUT**  
13-134-55 (1 3/8")  
23-134-55 (2 1/4")



**MAHOGANY**  
13-134-03 (1 3/8")  
23-134-03 (2 1/4")



**BRONZE**  
13-134-17 (1 3/8")  
23-134-17 (2 1/4")



**MOCHA**  
13-134-955 (1 3/8")  
23-134-955 (2 1/4")



**BLACK WALNUT**  
13-134-47 (1 3/8")  
23-134-47 (2 1/4")



**BLACK**  
13-134-45 (1 3/8")  
23-134-45 (2 1/4")



**GOLD WITH  
BLACK WASH**  
13-134-945 (1 3/8")  
23-134-945 (2 1/4")



**PLATINUM**  
13-134-960 (1 3/8")  
23-134-960 (2 1/4")



**ANTIQUE PEWTER**  
13-134-965 (1 3/8")  
23-134-965 (2 1/4")

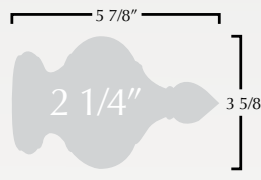
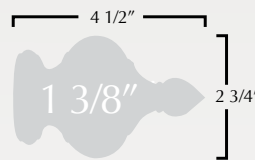
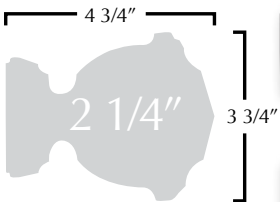
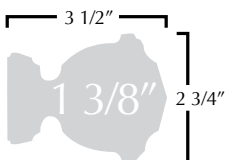

# 1 3/8" & 2 1/4" FINIALS



Select 1 3/8" Finials are packaged in pairs. Select 2 1/4" Finials are packaged as each.

## SOLARIS FINIAL

Wood

1 3/8"

3 1/2" L X 2 7/8" H

2 1/4"

5 1/8" L X 4 1/4" H

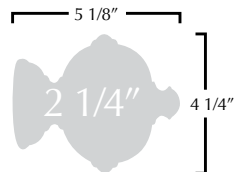
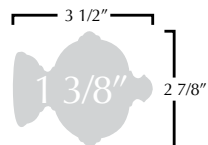

WHITE

13-135-50 (1 3/8")

23-135-50 (2 1/4")



LINEN

13-135-52 (1 3/8")

23-135-52 (2 1/4")



VINTAGE GOLD

13-135-23 (1 3/8")

23-135-23 (2 1/4")



WALNUT

13-135-55 (1 3/8")

23-135-55 (2 1/4")



MAHOGANY

13-135-03 (1 3/8")

23-135-03 (2 1/4")



BRONZE

13-135-17 (1 3/8")

23-135-17 (2 1/4")



MOCHA

13-135-955 (1 3/8")

23-135-955 (2 1/4")



BLACK WALNUT

13-135-47 (1 3/8")

23-135-47 (2 1/4")



BLACK

13-135-45 (1 3/8")

23-135-45 (2 1/4")



GOLD WITH  
BLACK WASH

13-135-945 (1 3/8")

23-135-945 (2 1/4")



PLATINUM

13-135-960 (1 3/8")

23-135-960 (2 1/4")



ANTIQUE PEWTER

13-135-965 (1 3/8")

23-135-965 (2 1/4")

## CAMBRIDGE FINIAL

Wood

1 3/8"

4 1/8" L X 2 7/8" H

2 1/4"

5 1/2" L X 3 3/4" H

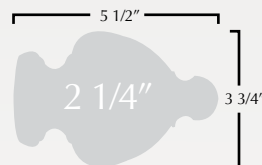
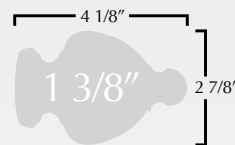

WHITE

13-137-50 (1 3/8")

23-137-50 (2 1/4")



LINEN

13-137-52 (1 3/8")

23-137-52 (2 1/4")



VINTAGE GOLD

13-137-23 (1 3/8")

23-137-23 (2 1/4")



WALNUT

13-137-55 (1 3/8")

23-137-55 (2 1/4")



MAHOGANY

13-137-03 (1 3/8")

23-137-03 (2 1/4")



BRONZE

13-137-17 (1 3/8")

23-137-17 (2 1/4")



MOCHA

13-137-955 (1 3/8")

23-137-955 (2 1/4")



BLACK WALNUT

13-137-47 (1 3/8")

23-137-47 (2 1/4")



BLACK

13-137-45 (1 3/8")

23-137-45 (2 1/4")



GOLD WITH  
BLACK WASH

13-137-945 (1 3/8")

23-137-945 (2 1/4")



PLATINUM

13-137-960 (1 3/8")

23-137-960 (2 1/4")



ANTIQUE PEWTER

13-137-965 (1 3/8")

23-137-965 (2 1/4")

All finials are available in Unfinished (76).



# 1 3/8" & 2 1/4" FINIALS

Select 1 3/8" Finials are packaged in pairs. Select 2 1/4" Finials are packaged as each.

## MISSION FINIAL

Wood  
1 3/8"  
3 1/2" L X 2 7/8" H  
2 1/4"  
5 1/4" L X 3 3/4" H

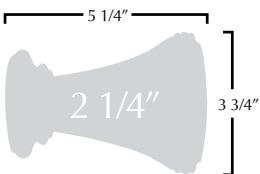
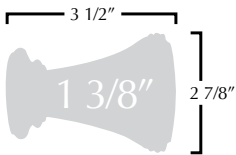

**WHITE**  
13-133-50 (1 3/8")  
23-133-50 (2 1/4")



**LINEN**  
13-133-52 (1 3/8")  
23-133-52 (2 1/4")



**VINTAGE GOLD**  
13-133-23 (1 3/8")  
23-133-23 (2 1/4")



**WALNUT**  
13-133-55 (1 3/8")  
23-133-55 (2 1/4")



**MAHOGANY**  
13-133-03 (1 3/8")  
23-133-03 (2 1/4")



**BRONZE**  
13-133-17 (1 3/8")  
23-133-17 (2 1/4")



**MOCHA**  
13-133-955 (1 3/8")  
23-133-955 (2 1/4")



**BLACK WALNUT**  
13-133-47 (1 3/8")  
23-133-47 (2 1/4")



**BLACK**  
13-133-45 (1 3/8")  
23-133-45 (2 1/4")



**GOLD WITH BLACK WASH**  
13-133-945 (1 3/8")  
23-133-945 (2 1/4")



**PLATINUM**  
13-133-960 (1 3/8")  
23-133-960 (2 1/4")



**ANTIQU PEWTER**  
13-133-965 (1 3/8")  
23-133-965 (2 1/4")

## OXFORD FINIAL

Wood  
1 3/8"  
3 1/8" L X 2 3/4" H  
2 1/4"  
4 1/2" L X 4" H

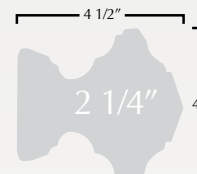
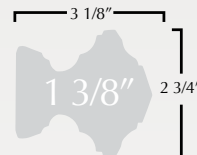

**WHITE**  
13-165-50 (1 3/8")  
23-165-50 (2 1/4")



**LINEN**  
13-165-52 (1 3/8")  
23-165-52 (2 1/4")



**VINTAGE GOLD**  
13-165-23 (1 3/8")  
23-165-23 (2 1/4")



**WALNUT**  
13-165-55 (1 3/8")  
23-165-55 (2 1/4")



**MAHOGANY**  
13-165-03 (1 3/8")  
23-165-03 (2 1/4")



**BRONZE**  
13-165-17 (1 3/8")  
23-165-17 (2 1/4")



**MOCHA**  
13-165-955 (1 3/8")  
23-165-955 (2 1/4")



**BLACK WALNUT**  
13-165-47 (1 3/8")  
23-165-47 (2 1/4")



**BLACK**  
13-165-45 (1 3/8")  
23-165-45 (2 1/4")



**GOLD WITH BLACK WASH**  
13-165-945 (1 3/8")  
23-165-945 (2 1/4")



**PLATINUM**  
13-165-960 (1 3/8")  
23-165-960 (2 1/4")



**ANTIQU PEWTER**  
13-165-965 (1 3/8")  
23-165-965 (2 1/4")

# 1 3/8" & 2 1/4" FINIALS



Select 1 3/8" Finials are packaged in pairs. Select 2 1/4" Finials are packaged as each.

**TRADITIONAL  
FINIAL - Wood**  
1 3/8"  
3 1/2" L X 2 3/8" H

**1 3/8" ONLY**

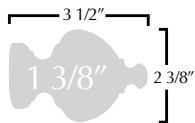

**WHITE**  
13-104-50 (1 3/8")



**LINEN**  
13-104-52 (1 3/8")



**VINTAGE GOLD**  
13-104-23 (1 3/8")



**WALNUT**  
13-104-55 (1 3/8")



**MAHOGANY**  
13-104-03 (1 3/8")



**BRONZE**  
13-104-17 (1 3/8")



**MOCHA**  
13-104-955 (1 3/8")



**BLACK WALNUT**  
13-104-47 (1 3/8")



**BLACK**  
13-104-45 (1 3/8")



**GOLD WITH  
BLACK WASH**  
13-104-945 (1 3/8")



**PLATINUM**  
13-104-960 (1 3/8")



**ANTIQUE PEWTER**  
13-104-965 (1 3/8")

**REGAL FINIAL**  
Wood  
2 1/4"  
6" L X 3 3/4" H

**2 1/4" ONLY**



**WHITE**  
23-103-50 (2 1/4")



**LINEN**  
23-103-52 (2 1/4")



**VINTAGE GOLD**  
23-103-23 (2 1/4")



**WALNUT**  
23-103-55 (2 1/4")



**MAHOGANY**  
23-103-03 (2 1/4")



**BRONZE**  
23-103-17 (2 1/4")



**MOCHA**  
23-103-955 (2 1/4")



**BLACK WALNUT**  
23-103-47 (2 1/4")



**BLACK**  
23-103-45 (2 1/4")



**GOLD WITH  
BLACK WASH**  
23-103-945 (2 1/4")



**PLATINUM**  
23-103-960 (2 1/4")



**ANTIQUE PEWTER**  
23-103-965 (2 1/4")

All finials are available in Unfinished (76).

**2 1/4" TRADITIONAL BRACKET**

23-204

5 1/2" H, 4 1/4" Return

23-207

5 1/2" H, 7" Return

Available In All Finishes

*(Sold in pairs)*



**1 3/8" TRADITIONAL BRACKET**

13-203

3 3/4" H, 3 1/2" Return

13-206

3 3/4" H, 6" Return

Available In All Finishes

*(Sold in pairs)*



**1 3/8" EUROPEAN BRACKET**

13-223

2 1/2" H, 3 1/2" Return

Available In All Finishes

*(Sold in pairs)*



# Wood Brackets

**1 3/8" DOUBLE BRACKET**

13-236

4" H, 2 3/4" & 6" Return

1 3/8" Front Pole, 1 3/8" Back Pole

Finishes: 03, 17, 23, 45, 47, 50, 52, 55, 76, 955

*(Sold in pairs)*



**2 1/4" EUROPEAN BRACKET**

23-224

4 5/8" H, 4 1/4" Return

Available In All Finishes

*(Sold in pairs)*



**2 1/4" DOUBLE BRACKET**

23-237

5 1/2" H, 3" & 7" Return

2 1/4" Front Pole, 1 3/8" Back Pole

Finishes: 03, 17, 23, 45, 47, 50, 52, 55, 76, 955

*(Sold in pairs)*

**1 3/8" METAL CEILING BRACKET**

10-255  
5 3/8" Drop, 4" Base  
Finishes: 17, 23, 45, 50  
(Sold as each)



**2 1/4" METAL CEILING BRACKET**

20-255  
6 3/4" Drop, 4" Base  
Finishes: 17, 23, 45, 50  
(Sold as each)

**1 3/8" IRON BRACKET**

10-273  
4" H, 3 1/2" Return  
Finish: 40  
(Sold as each)



**2 1/4" IRON BRACKETS**

20-274  
4" H, 4 1/4" Return  
Finish: 40  
(Sold as each)

# Metal Brackets

**1 3/8" CENTER SUPPORT BRACKET**

10-283  
1 1/8" H, 3 1/2" Return  
Finishes: 17, 23, 45, 50  
(Sold as each)



**2 1/4" CENTER SUPPORT BRACKET**

20-284  
1 1/8" H x 4 1/4" Return  
Finishes: 17, 23, 45, 50  
(Sold as each)

**1 3/8" POLE COMBINATION BRACKET**

10-296  
4" H, 6 1/2" Pole Return  
Finishes: 17, 23, 45, 50  
(Sold as each) (Clips are sold separately)



**2 1/4" POLE COMBINATION BRACKET**

20-297  
4" H, 7" Pole Return  
Finishes: 17, 23, 45, 50  
(Sold as each) (Clips are sold separately)



**1 3/8" METAL BRACKET**

10-203  
2 3/4" H, 3 1/2" - 4 1/2" Return  
Finishes: 17, 23, 45, 50  
(Sold as each)



**2 1/4" METAL BRACKET**

20-204  
2 3/4" H, 4" - 5 1/2" Return  
Finishes: 17, 23, 45, 50  
(Sold as each)



**Wood & Metal Finishes:**

- |                   |                      |
|-------------------|----------------------|
| Mahogany (03)     | Walnut (55)          |
| Bronze (17)       | Unfinished (76)      |
| Vintage Gold (23) | Gold with            |
| Charcoal (40)     | Black Wash (945)     |
| Black (45)        | Mocha (955)          |
| Black Walnut (47) | Platinum (960)       |
| White (50)        | Antique Pewter (965) |
| Linen (52)        |                      |

All metal brackets are sold as each.

**1 3/8" SMOOTH WOOD RINGS**

13-300  
I.D. 1 7/8", O.D. 2 7/8"  
Available In All Finishes  
(7 Rings per package)



**Rings**



**1 3/8" IRON RINGS**

10-370-40 - 1 3/8"  
1 3/4" I.D., 2 1/2" O.D.  
(7 Rings per package)

**2 1/4" IRON RINGS**

20-370-40 - 2 1/4"  
2 1/2" I.D., 3 1/4" O.D.  
(7 Rings per package)



**1 3/8" METAL RINGS**

10-300 - 1 3/8"  
I.D. 1 3/4", O.D. 2 1/4"  
Finishes: 17, 23, 45, 50  
(7 Rings per package)

**2 1/4" METAL RINGS**

20-300 - 2 1/4"  
I.D. 2 5/8", O.D. 3 1/8"  
Finishes: 17, 23, 45, 50  
(7 Rings per package)

**2 1/4" RIBBED WOOD RINGS**

23-345  
2 5/8" I.D., 4 1/4" O.D.  
Available in All Finishes  
(4 Rings per package)



**2 1/4" BRADFORD RESIN RINGS**

24-344  
3 1/4" I.D., 4 5/8" O.D.  
Finishes: 03, 17, 23, 47, 52, 55,  
945, 955, 960, 965  
(4 Rings per package)

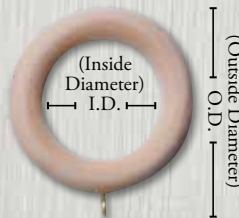



**1 3/8" SWIVEL SOCKET**

13-453  
Available In All Finishes  
(Sold as each)

**2 1/4" SWIVEL SOCKET**

23-453  
Available In All Finishes  
(Sold as each)



**1 3/8" SMOOTH ELBOW**

13-460  
3 1/2" or 5 1/2" Clearance  
4 7/8" or 6 7/8" Projection  
Finishes: 03, 17, 23, 45,  
47, 50, 52, 55, 76, 955  
(Sold in pairs)

**2 1/4" SMOOTH ELBOW**

23-460  
3 1/4" or 5 1/2" Clearance  
5 1/2" or 7 3/4" Projection  
Finishes: 03, 17, 23, 45,  
47, 50, 52, 55, 76, 955  
(Sold in pairs)

# Accessories

**1 3/8" SMOOTH WOOD RINGS**

13-300  
I.D. 1 7/8", O.D. 2 7/8"  
Available In All Finishes  
(7 Rings per package)



**BATONS**

53-470  
36" Wood Baton  
Finishes: 03, 17, 23, 45, 47,  
50, 52, 55, 76, 955



**CONNECTOR SCREW**

10-499  
1 3/8" Connector Screw  
For Use With 1 3/8" Poles  
Finish: 91 (Zinc)

20-499  
2 1/4" Connector Screw  
For Use With 2 1/4" Poles  
Finish: 91 (Zinc)



**2 1/4" INSIDE MOUNT SOCKET**

23-450  
Available In All Finishes  
(Sold in pairs)

**1 3/8" INSIDE MOUNT SOCKET**

13-450  
Available In All Finishes  
(Sold in pairs)





# 3" SELECT POLES & END CAPS



Unfinished (76) – Reeded Pole  
Unfinished (76) – Smooth Pole



Black Walnut (47) – Reeded Pole  
Black Walnut (47) – Smooth Pole



Mocha (955) – Reeded Pole  
Mocha (955) – Smooth Pole

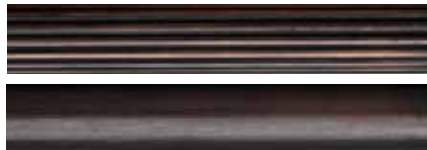

Bronze (17) – Reeded Pole  
Bronze (17) – Smooth Pole

## Select Smooth & Reeded Poles

Description	4'	6'	8'	12'	16'
3" Smooth Pole	31-004	31-006	31-008	31-012	31-016
3" Reeded Pole	32-004	32-006	32-008	32-012	32-016

Select 3" End Caps are packaged as each.

### WOOD END CAP

3" - 2" L X 4 1/8" H



UNFINISHED  
33-140-76



BRONZE  
33-140-17



MOCHA  
33-140-955



BLACK WALNUT  
33-140-47

### VESTA WOOD END CAP

3" - 2 1/2" L X 3 3/4" H



UNFINISHED  
33-145-76



BRONZE  
33-145-17



MOCHA  
33-145-955



BLACK WALNUT  
33-145-47

### BRADFORD RESIN END CAP

3" - 2" L X 4 1/8" H



BRONZE  
34-144-17



MOCHA  
34-144-955



BLACK WALNUT  
34-144-47

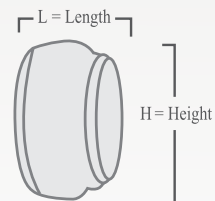

End Cap Dimensions

# 3" FINIALS



Select 3" Finials are packaged as each.

## BALL FINIAL - Wood

3" - 6 1/4" L X 4 1/2" H



UNFINISHED  
33-101-76



BRONZE  
33-101-17



MOCHA  
33-101-955



BLACK WALNUT  
33-101-47

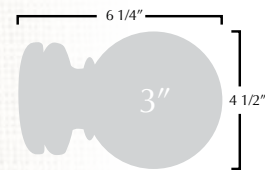



# 3" FINIALS

Select 3" Finials are packaged as each.

## REEDED BALL FINIAL - Wood

3" - 6 1/8" L X 4 3/8" H



UNFINISHED  
33-108-76



BRONZE  
33-108-17



MOCHA  
33-108-955



BLACK WALNUT  
33-108-47

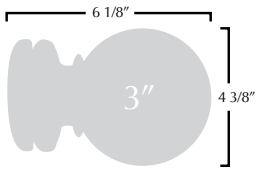

## ACORN FINIAL - Wood

3" - 6 1/8" L x 4 3/8" H



UNFINISHED  
33-131-76



BRONZE  
33-131-17



MOCHA  
33-131-955



BLACK WALNUT  
33-131-47

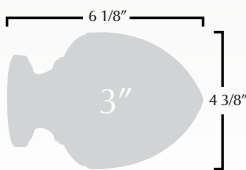

## WESTWOOD FINIAL -Wood

3" - 5 3/4" L x 4 1/4" H



UNFINISHED  
33-138-76



BRONZE  
33-138-17



MOCHA  
33-138-955



BLACK WALNUT  
33-138-47

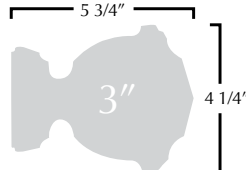

# 3" Brackets

### 3" EUROPEAN BRACKET

33-224

6 1/4" H, 4 1/4" Return

Finishes: 17, 47, 76, 955

(Sold in pairs)



### 3" METAL BRACKET

30-204

2 3/4" H, 4 1/4" - 5 1/2" Return

Finishes: 17, 45, 50

(Sold as each)



### 3" TRADITIONAL BRACKET

33-204

6 1/4" H, 4 1/4" Return  
Finishes: 17, 47, 76, 955

33-207

6 1/4" H, 7" Return  
Finishes: 17, 47, 76, 955

(Sold in pairs)

# 3" FINIALS



Select 3" Finials are packaged as each.

**NEWPORT FINIAL - Resin**  
3" - 6 1/4" L X 4 5/8" H



**BRONZE**  
34-128-17



**MOCHA**  
34-128-955



**BLACK WALNUT**  
34-128-47

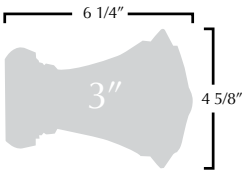

**LIBERTY FINIAL - Resin**  
3" - 7 1/2" L X 4 1/2" H



**BRONZE**  
34-127-17



**MOCHA**  
34-127-955



**BLACK WALNUT**  
34-127-47



**VALENCIA FINIAL - Resin**  
3" - 6 3/4" L X 3 7/8" H



**BRONZE**  
34-126-17



**MOCHA**  
34-126-955



**BLACK WALNUT**  
34-126-47

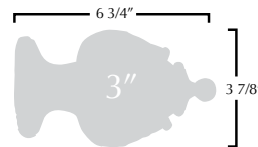

## 3" Rings & Accessories



**3" RIBBED WOOD RINGS**

33-345  
3 1/2" I.D., 5" O.D.  
Finishes: 17, 47, 76, 955  
(4 Rings per package)

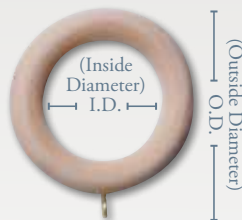

**CONNECTOR SCREW**  
20-499  
3" Connector Screw  
For Use With 3" Poles  
Finish: 91 (Zinc)

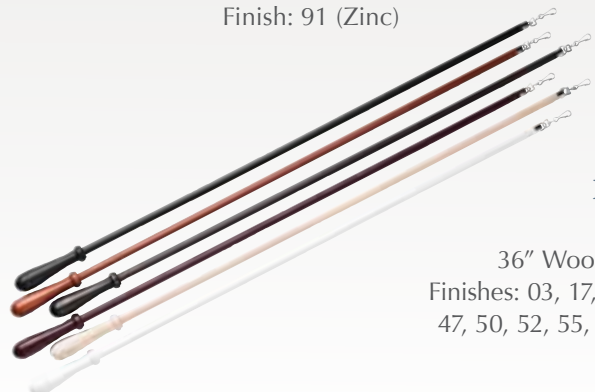

**BATONS**  
53-470  
36" Wood Baton  
Finishes: 03, 17, 23, 45,  
47, 50, 52, 55, 76, 955





SELECT  
*Rustic* ELEGANCE

# 1 3/8" & 2 1/4" RUSTIC ELEGANCE FINIALS

## Rustic Ball Finial

1 3/8" - 3 3/4" L x 2 1/2" H  
2 1/4" - 5 1/8" L x 3 1/4" H



**NATURAL**  
13-161-715 (1 3/8")  
23-161-715 (2 1/4")



**ENGLISH CHESTNUT**  
13-161-725 (1 3/8")  
23-161-725 (2 1/4")



**PECAN**  
13-161-735 (1 3/8")  
23-161-735 (2 1/4")



**AMERICAN WALNUT**  
13-161-755 (1 3/8")  
23-161-755 (2 1/4")



**ESPRESSO**  
13-161-745 (1 3/8")  
23-161-745 (2 1/4")

## Hampton Finial

1 3/8" - 3" L x 2 3/4" H  
2 1/4" - 4 1/2" L x 4" H



**NATURAL**  
13-167-715 (1 3/8")  
23-167-715 (2 1/4")



**ENGLISH CHESTNUT**  
13-167-725 (1 3/8")  
23-167-725 (2 1/4")



**PECAN**  
13-167-735 (1 3/8")  
23-167-735 (2 1/4")



**AMERICAN WALNUT**  
13-167-755 (1 3/8")  
23-167-755 (2 1/4")



**ESPRESSO**  
13-167-745 (1 3/8")  
23-167-745 (2 1/4")

## Oxford Finial

1 3/8" - 3 1/8" x 2 3/4" H  
2 1/4" - 4 1/2" L x 4" H



**NATURAL**  
13-165-715 (1 3/8")  
23-165-715 (2 1/4")



**ENGLISH CHESTNUT**  
13-165-725 (1 3/8")  
23-165-725 (2 1/4")



**PECAN**  
13-165-735 (1 3/8")  
23-165-735 (2 1/4")



**AMERICAN WALNUT**  
13-165-755 (1 3/8")  
23-165-755 (2 1/4")



**ESPRESSO**  
13-165-745 (1 3/8")  
23-165-745 (2 1/4")





# 1 3/8" & 2 1/4" FINIALS & END CAPS

## Camden Finial

1 3/8" - 3 1/4" L x 3" H

2 1/4" - 4 1/2" L x 4" H



### NATURAL

13-163-715 (1 3/8")

23-163-715 (2 1/4")



### ENGLISH CHESTNUT

13-163-725 (1 3/8")

23-163-725 (2 1/4")



### PECAN

13-163-735 (1 3/8")

23-163-735 (2 1/4")



### AMERICAN WALNUT

13-163-755 (1 3/8")

23-163-755 (2 1/4")



### ESPRESSO

13-163-745 (1 3/8")

23-163-745 (2 1/4")



## Newbury End Cap

1 3/8" - 1" L x 2 3/8" H

2 1/4" - 1 1/2" L x 3 3/8" H



### NATURAL

13-146-715 (1 3/8")

23-146-715 (2 1/4")



### ENGLISH CHESTNUT

13-146-725 (1 3/8")

23-146-725 (2 1/4")



### PECAN

13-146-735 (1 3/8")

23-146-735 (2 1/4")

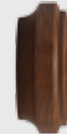

### AMERICAN WALNUT

13-146-755 (1 3/8")

23-146-755 (2 1/4")

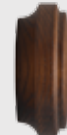

### ESPRESSO

13-146-745 (1 3/8")

23-146-745 (2 1/4")



*(1 3/8" & 2 1/4" End Caps packaged in pairs.)*

*(1 3/8" Finials are packaged in pairs. 2 1/4" Finials are packaged as each.)*



# DEFINES Elegance

Add a contrasting design element to your project by using the authentic iron rings and brackets in the Charcoal finish or simply coordinate the **Rustic Elegance** accessories to your poles and finials.

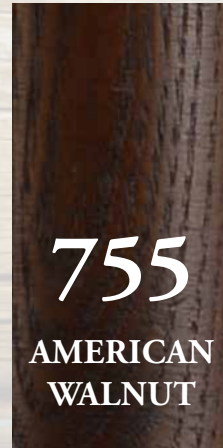
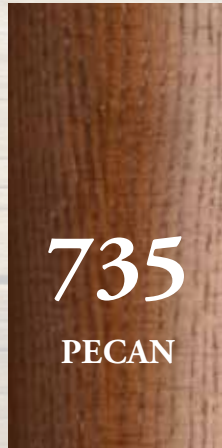
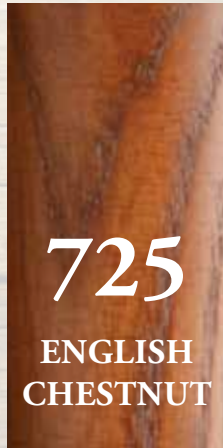

## The Rustic Finishes

**1 3/8" Iron Rings**  
10-370  
1 3/4" I.D., 2 1/2" O.D.  
(7 Rings per package)



**2 1/4" Iron Rings**  
20-370  
2 1/2" I.D., 3 1/4" O.D.  
(7 Rings per package)

**1 3/8" Wood Rings**  
13-300  
1 7/8" I.D., 2 7/8" O.D.  
(7 Rings per package)



### 1 3/8" Smooth Wood Poles

- 11-004 4' Smooth Poles
- 11-006 6' Smooth Poles
- 11-008 8' Smooth Poles
- 11-012 12' Smooth Poles

### 2 1/4" Smooth Wood Poles

- 21-004 4' Smooth Poles
- 21-006 6' Smooth Poles
- 21-008 8' Smooth Poles
- 21-012 12' Smooth Poles



**2 1/4" Ribbed  
Wood Rings**  
23-345  
2 5/8" I.D.,  
4 1/4" O.D.  
(4 Rings per  
package)



**2 1/4" Wood Bracket  
Wall / Ceiling Mount**  
23-264  
4 1/4" Wall Mount Return,  
5 1/4" Ceiling Drop,  
3 1/4" Base Diameter  
*(Sold as each)*

**2 1/4" European Bracket**  
23-224  
4 5/8" H, 4 1/4" Return  
*(Sold in pairs)*



23-264  
Wall Mounted

# Accessories



**1 3/8" European Bracket**  
13-223  
2 1/2" H, 3 1/2" Return  
*(Sold in pairs)*



**Omni Holdback**  
4" Diameter  
53-764  
Spindle Projection - 2", 4", or 6"  
2 1/2" Base Diameter  
*(Sold in pairs)*



**1 3/8" Iron Bracket**  
10-273  
4" H, 3 1/2" Return  
Finish: 40  
*(Sold as each)*

**2 1/4" Iron Bracket**  
20-274  
4" H, 4 1/4" Return  
Finish: 40  
*(Sold as each)*



# 1 3/8" Iron Image

Included in the Rustic Elegance Collection is the specialty line, Iron Image. Iron Image offers the look of traditional wrought iron in 1 3/8" diameter wood poles, traverse rods and finials. The matte, charcoal finish gives the four finial designs and wood poles the look of forged iron. Authentic iron rings and brackets complete this collection.

CHARCOAL  
40

# 1 3/8" IRON IMAGE



**Westwood Finial**  
13-138 - 1 3/8"  
3 1/2" L x 2 3/4" H  
(Sold in pairs)



**Ball Finial**  
13-101 - 1 3/8"  
3 3/8" L x 2 3/8" H  
(Sold in pairs)



**Mission Finial**  
13-133 - 1 3/8"  
3 1/2" L x 2 7/8" H  
(Sold in pairs)



**Vesta End Cap**  
13-145 - 1 3/8"  
1 3/4" L x 2 3/8" H  
(Sold in pairs)



**Iron Rings**  
10-370 - 1 3/8"  
1 3/4" I.D., 2 1/2" O.D.  
(7 Rings per package)



**Iron Brackets**  
10-273 - 1 3/8"  
4" H, 3 1/2" Return  
(Sold as each)

**Smooth Wood Poles 1 3/8"**  
11-004 4' Smooth Poles  
11-006 6' Smooth Poles  
11-008 8' Smooth Poles  
11-012 12' Smooth Poles

Charcoal (40)









# SELECT TRAVERSE RODS



## Premium

### Traverse Rod Sets with Plain Carriers

Available with 1 3/8", 2 1/4", and 3" diameter wood fascia with plain wheeled carriers. The 2-wheeled carriers allow a smooth operation for all drapery treatments.



- Premium Traverse Rod Sets are also available without wood fascia for a commercial or a more contemporary look.
- Tracks are heavy duty and available in finish Bronze (17) or Aluminum (90).
- Traverse Rod Sets are available in
  - 13 Select Wood finishes**
  - 5 Rustic Elegance finishes and**
  - 1 Iron Image finish**
- Double Traverse Rod Sets available with or without fascia.
- Premium Traverse Rod Sets are available for Pinch Pleat and Ripplefold® draperies.

### Traverse Rod Sets with Patented SureLock® Ring System

## Supreme



Available with 2 1/4" and 3" diameter fascia. SureLock® Traverse Rings simply snap into the 4-wheeled carriers for an easy installation. The Surelock® Rings and 4-wheeled carriers ensure the rings maintain a consistent appearance and allow a smooth operation.

#### Two decorative ring options available:

- Ribbed Wood Rings
- Bradford Resin Rings

#### Double Traverse Rod Set Options:

- Available with back rod 1 3/8" fascia attached or as "track only" in finish Bronze (17) or Aluminum (90).
- 1 3/8" fascia available in all Select and Rustic Elegance finishes.
- Rings are not available on back track.





# Premium & Supreme Rod Sets

feature heavy duty tracks that are constructed with wheeled carriers and metal masters with the capacity to handle today's drapery treatments made with blackout linings and interlinings.

## Traverse Rods Sets

- Assembled to Order.\*
- Cord draw standard.
- Hand draw option includes 36" White Fiberglass Baton.
- Assembled set includes approximately 3.5 wheeled carriers or SureLock® Traverse Rings per foot, standard installation brackets (3"- 4" Return), center support bracket cover(s), and tension pulley.
- Ripplefold available with Premium Track.
- Maximum continuous set length - 16 ft.
- Maximum set with Mitered Returns - 15 ft.
- Mitered cuts are available for a surcharge.
- Drapery weight – 4 lbs. per foot.
- Finials, End Caps, and Mitered Returns are not included. Please order separately.
- Double Traverse Rod Sets are available with back rod as "track only" or track with 1 3/8" fascia.

\* Production time - 10 working days



**NATURAL RUSTIC ELEGANCE SUPREME TRAVERSE ROD**



**BLACK WALNUT SELECT SUPREME TRAVERSE ROD**



**PLATINUM SELECT PREMIUM TRAVERSE ROD**



**GOLD WITH BLACK WASH SELECT PREMIUM TRAVERSE ROD**



**Patented SureLock® Ring System**



**SELECT WOOD BATONS  
53-470**

	<b>WARNING</b>		<b>ADVERTENCIA</b>
<p>The cords on certain products present a potential strangulation hazard. For child safety, consider cordless alternatives or products with inaccessible cords.</p>		<p>Los cables en algunos productos que presente un peligro potencial estrangulación. Para la seguridad del niño, considere inalámbrico alternativas o productos con cuerdas inaccesibles.</p>	

# Flat Fascia Traverse Rods

Flat Fascia Traverse Rods offer a more contemporary design and are available in six Select Wood finishes and five Rustic Elegance finishes. The fascia is 1 3/4" high and the rods are assembled with the Select Premium Track with Pinch Pleat or Ripplefold® carriers. Square Finials, Mitered Elbows and Metal End Caps are available and must be ordered separately.

## Select Rustic Elegance



715 NATURAL

725 ENGLISH CHESTNUT

735 PECAN

745 ESPRESSO

755 AMERICAN WALNUT

### SQUARE WOOD FINIAL

23-169  
3" L x 2" H



NATURAL  
23-169-715



ENGLISH CHESTNUT  
23-169-725



PECAN  
23-169-735



ESPRESSO  
23-169-745



AMERICAN WALNUT  
23-169-755

### SQUARE METAL END CAP

20-154  
1/2" L x 2" H  
Nickel (760), Steel (767)



Nickel (760)



Steel (767)

### SQUARE MITERED ELBOW

23-468  
2 1/2" L x 2" H,  
5 1/2" Maximum Return  
Custom cut available

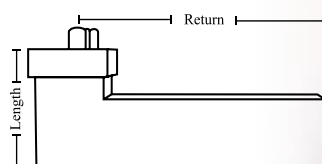

Square Mitered Elbow



For custom mitered returns see page 43.

(End Caps, Finials, and Elbows sold as each)  
Metal Collar in Nickel (760) only.

# SELECT TRAVERSE RODS



## Flat Fascia Traverse Rod



### SQUARE WOOD FINIAL

**23-169**  
3" L x 2" H



**WHITE/STEEL**  
23-169-50

**BRONZE/NICKEL**  
23-169-17

**MOCHA/NICKEL**  
23-169-955

**BLACK/STEEL**  
23-169-45

**PLATINUM/STEEL**  
23-169-960

Metal Collar finish noted

### SQUARE MITERED ELBOW

**23-468**  
2 1/2" L x 2" H, 5 1/2" Maximum Return  
Custom cut available



**WHITE/STEEL**  
23-468-50



**BRONZE/NICKEL**  
23-468-17



**MOCHA/NICKEL**  
23-468-955

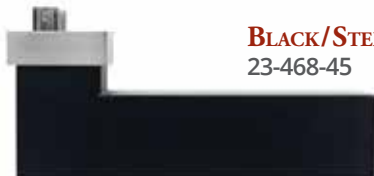

**BLACK/STEEL**  
23-468-45



**PLATINUM/STEEL**  
23-468-960

Metal Collar finish noted

### SQUARE METAL END CAP

**20-154**  
1/2" L x 2" H  
Nickel (760), Steel (767)



Nickel (760)



Steel (767)

### UNFINISHED FINIALS & ELBOWS



**UNFINISHED ELBOW**  
23-468P-76



**UNFINISHED FINIAL**  
23-169P-76

The collars for Unfinished are sold separately and available in Nickel (760) and Steel (767).

### SQUARE METAL COLLAR

**20-150**



**NICKEL COLLAR**  
20-150-760



**STEEL COLLAR**  
20-150-767

For custom mitered returns see page 43.



# SELECT TRAVERSE RODS

## Custom Mitered Cut Traverse Rods for Bay and Corner Windows

For All Mitered Traverse Rods, including Bay Window

- Specify if wall or track measurement.
- Specify bracket return.
- Each track segment operates independently.
- A surcharge is applied for each miter cut.

For Bay Windows

- Templates are required.
- Provide all required measurements and degrees of angles. See drawing.

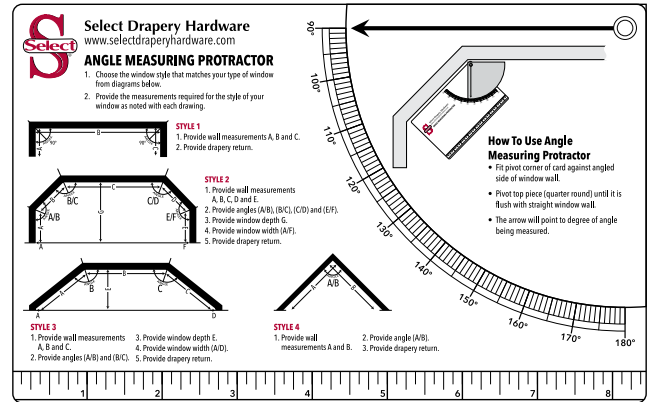

SELECT PROTRACTOR PRO-2016

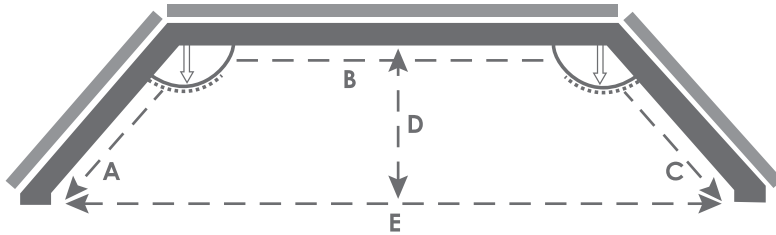

## Custom Cut Mitered Returns

- Available with all Select Traverse Rods.
- Order by track width. See drawing.
- Specify drapery return.

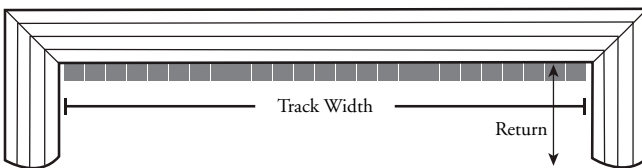

CUSTOM MITERED RETURN WITH FASCIA



CUSTOM MITERED RETURN WITH FLAT FASCIA

# SELECT TRAVERSE RODS



## SPECIFY THE FOLLOWING WHEN ORDERING TRAVERSE RODS:

- Quantity
- Fascia Style (Smooth, Reeded, or Flat)
- Finish
- Track Length
- Draw (Right, Left or Center)
- Pinch Pleat or Ripplefold®
- Ripplefold® - specify fullness and Overlap or Butt Master
- Cord Placement and Drop (Standard 8 ft.)
- Wall or Ceiling Mount
- Return (If other than 3 1/2" additional charges may apply)
- Order Finials or End Caps Separately

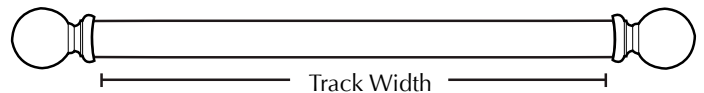

## BRACKETS SUPPLIED WITH TRAVERSE ROD

Brackets and supports included, determined by rod length:

Up to 48"	2 End Brackets
49" to 90"	2 End Brackets; 1 Center Support Bracket
91" to 138"	2 End Brackets; 2 Center Support Brackets
139" to 174"	2 End Brackets; 3 Center Support Brackets
175" to 192"	2 End Brackets; 4 Center Support Brackets

## Masters

Premium Traverse Rod Masters & Carriers

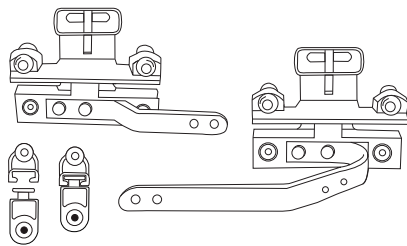

Supreme Traverse Rod Masters & SureLock® Rings

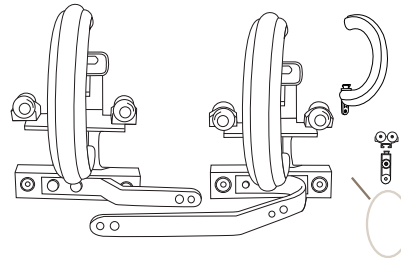

Premium Ripplefold® Overlap Master

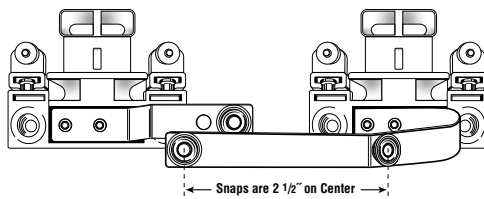

Premium Ripplefold® Butt Master

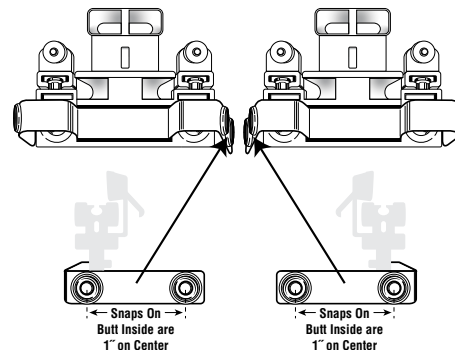

Center of Snap Locations

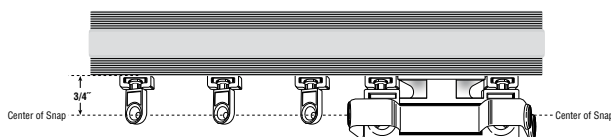



# SELECT TRAVERSE RODS

## Combination Brackets



**2 1/4" FULL ROUND POLE WITH 2 1/4" WOOD FASCIA TRAVERSE ROD AS BACK ROD**

1 3/8" and 2 1/4" Select Combination Brackets give the flexibility to install 1 3/8" or 2 1/4" full round pole with rings in front of a Traverse Rod. The brackets offer the versatility of allowing the back rod to be:

- Back Rod Premium Track with 2 1/4" Wood Fascia.
- Back Rod Premium Track with 1 3/8" Wood Fascia.
- Back Rod Premium Track only.



**2 1/4" FULL ROUND POLE WITH 1 3/8" WOOD FASCIA TRAVERSE ROD AS BACK ROD**

Combination Brackets are available in 4 finishes:

- Black (45)
- Bronze (17)
- Vintage Gold (23)
- White (50)

Combination brackets must be specified when ordering the back traverse rod and is available with a surcharge.



**2 1/4" FULL ROUND POLE WITH PREMIUM TRACK ONLY TRAVERSE ROD AS BACK ROD**

These brackets are designed for the installation of the front and back drapery to be at the same height when used with Select Premium Traverse Rod behind a Select Pole with Select Wood Rings.



**1 3/8" Pole & Traverse Rod Combination Bracket - 10-296**  
*Bracket must be specified with order.*

**2 1/4" Pole & Traverse Rod Combination Bracket - 20-297**  
*Bracket must be specified with order.*

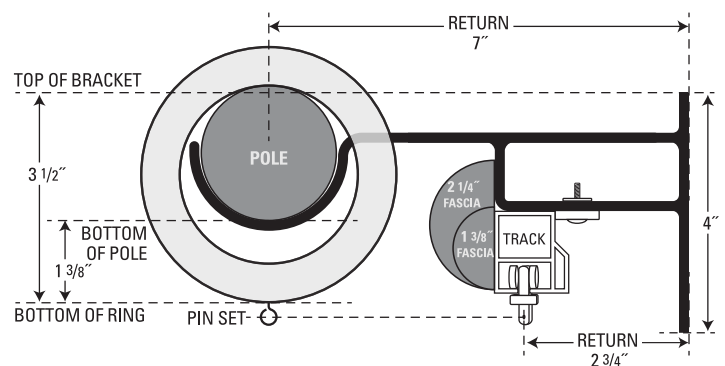
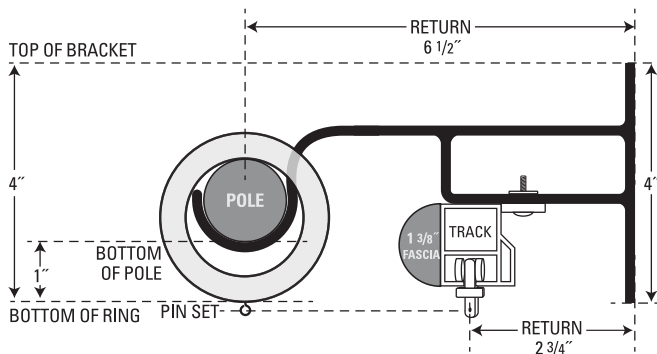

# SELECT TRAVERSE RODS



## Brackets

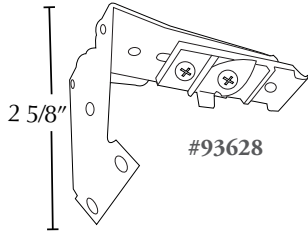

Standard Wall End Bracket

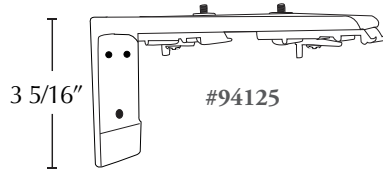

Double Wall Bracket  
or 6" Projection Bracket

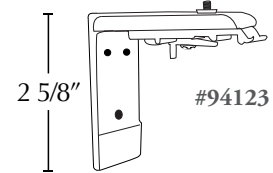

Heavy Duty Single  
Wall Bracket

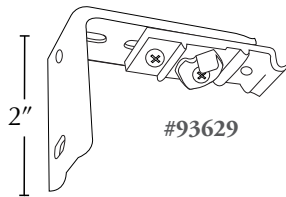

Standard Center  
Support Bracket

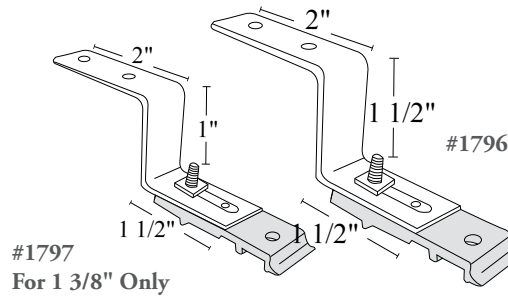

Ceiling Mount Brackets

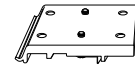

Track Splice  
#93633



Support Cover  
#93699

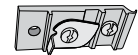

Mounting Clip  
#93630

### Bracket Details

Description	Item No.	Finishes	Returns
Standard Wall End Bracket	93628	025, 85	3" - 4" Return
Standard Center Support Bracket	93629	025, 85	3" - 4" Return
Ceiling / Mounting Clip for Select Traverse Rods	93630	17, 90	
Track Splice	93633	17, 90	
Center Support Cover	93699	025	
Heavy Duty Single Wall Bracket **	94123	025, 85, 90	3 1/2" - 4 1/2" Return
Double or 6" Projection Bracket **	94125	025, 85, 90	5 1/2" Return
Ceiling Mount Bracket - 1 1/2" Drop **	1796	61	1 1/2" Drop
Ceiling Mount Bracket - 1" Drop **	1797	61	1" Drop
1 3/8" Pole / Traverse Combination Bracket **	10-296	17, 23, 45, 50	6 1/2" Pole Return
2 1/4" Pole / Traverse Combination Bracket **	20-297	17, 23, 45, 50	7" Pole Return

\*\* Mounting Clips (93630) are not included when purchased separately

Finishes: • Bronze (17 & 85) • Vintage Gold (23) • White (025 & 50) • Black (45) • Zinc (61) • Aluminum (90)



# ORDERING INFORMATION

## PLACING YOUR ORDER

The color photos in this brochure are a close representation of the finishes available. Finishes are hand finished so there may be color variations. Please refer to your Select Color Selectors #2016SEL, 2013SRE or Select Binder #2016SWB for actual samples of the finishes.

1 3/8" Finials are packaged in pairs. The 2 1/4" and 3" Finials are packaged as each.

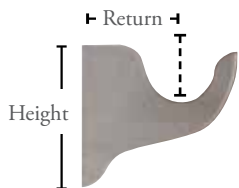

TRADITIONAL BRACKET

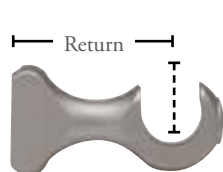

EUROPEAN BRACKET

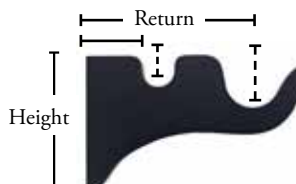

DOUBLE BRACKET

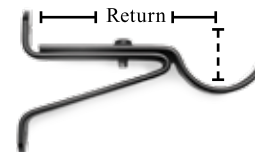

METAL BRACKET

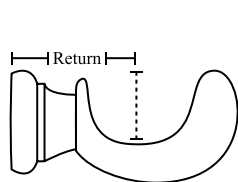

RUSTIC ELEGANCE WOOD BRACKET WALL MOUNT

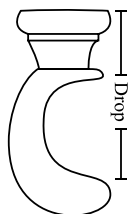

RUSTIC ELEGANCE WOOD BRACKET CEILING MOUNT

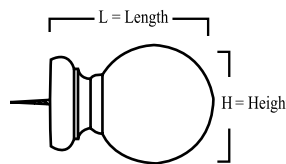

FINIAL

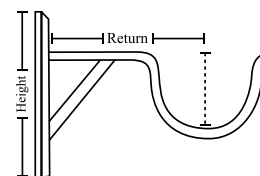

IRON BRACKET

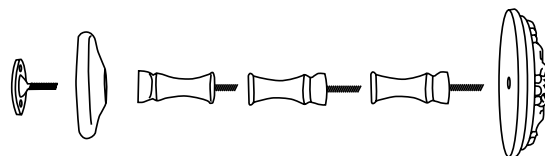

HOLDBACK



ELBOW

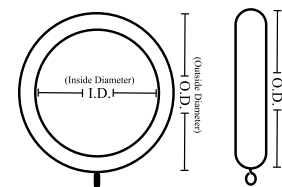

RING

## Lifetime Limited Warranty

Selective Enterprises, Inc. provides a lifetime limited warranty on all Select Drapery Hardware and Select Traverse Rods. Selective Enterprises, Inc. warrants that these products will be free from defects due to faulty workmanship or materials. This warranty extends to the original residential retail purchaser.

If a Selective Enterprises, Inc. product is found to be defective during the warranty period, we will at our discretion repair or replace the defective product at no charge. Repair or replacement of defective products is the sole remedy under this warranty and in no event shall Selective Enterprises, Inc. be liable for costs to remove, replace, transport or reinstall or incidental or consequential damages.

This warranty does not cover normal wear and tear or any damage or loss by accidents, alterations, improper use, abuse, neglect, or improper installation, cleaning or other maintenance. The warranty shall be void if product is moved from its original installed location. Select products may gradually lose color intensity after long exposure to direct sun. This color loss is not covered by the warranty. All cords eventually wear out. This is considered normal wear and tear not covered by warranty. The warranty does not cover removal, installation, replacement, or shipping costs.



# DISPLAYS & SALES AIDS

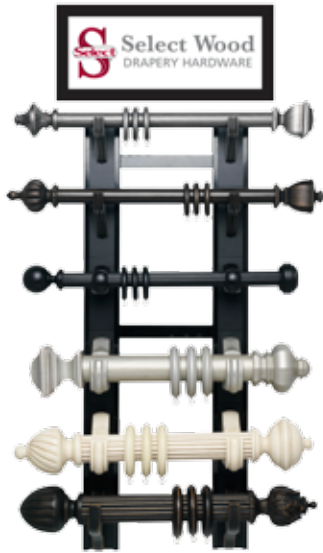

2016S2DK



2016S3DK



2016SREDK



2016STDK



2016SRTDK



2013SRE



2016SEL



# DISPLAYS & SALES AIDS



**SELECT PRODUCT BINDER**  
2016SWB



**SELECT SAMPLE CASE**  
2016SSC



**RUSTIC ELEGANCE SAMPLE CASE**  
2013SREC



**RUSTIC ELEGANCE  
TABLE TOP DISPLAY**  
2013SRED

## Select Sales Aids

Item No.	Description
2016SWB	<b>Select Product Binder</b> Includes: Select Wood Brochure, Wholesale Price List, and Finish Samples including Rustic Elegance, Select Metal Brochure, Wholesale Price List and Finish Samples
2016SEL	<b>Select Wood Collection Finish Selector</b> Includes: 13 Finishes on 6" Slats
2013SRE	<b>Select Rustic Elegance Finish Selector</b> Includes: 5 Rustic Elegance Finishes and Iron Image Finish on 6" Slats
2016SSC	<b>Select Wood Sample Case</b> Includes: 5 Finial Designs, 1 End Cap, 1 Holdback, 5 Rings, Pole Samples, Finish Selectors (2016SEL & 2013SRE), Brochure & Price List
2013SREC	<b>Select Rustic Elegance Wood Sample Case</b> Includes: 5 Finial / End Cap Designs, 1 Holdback, 2 Rings, Pole and Flat Fascia Samples Finish Selectors (2016SEL & 2013SRE), Brochure & Price List
2016SELB	<b>Select Color Brochure</b>
2016SPL	<b>Select Wholesale Price List</b>



## Select Displays

Item No.	Description	Dimension
2013SRED	<b>Select Rustic Elegance Table Top Display</b> Includes: 5 - 2 1/4" Rustic Elegance Finishes, Poles, and Finials 1 - 1 3/8" Iron Image Pole with Vesta End Cap	12" X 12"
2016S2DK	<b>1 3/8" &amp; 2 1/4" Select Wood Wall Display</b> Features: 3 - 1 3/8" Poles; 3 - 2 1/4" Poles; 12 Decorative Finial Designs 6 Finishes - White, Walnut, Black Walnut, Vintage Gold, Mahogany, & Mocha Includes Mounting Rails and Signage	30" W X 46" H
2016S3DK	<b>1 3/8", 2 1/4" &amp; 3" Select Wood Wall Display</b> Features: 3 - 1 3/8" Poles; 2 - 2 1/4" Poles; 1 - 3" Pole; 12 Decorative Finial Designs 6 Finishes - White, Walnut, Black Walnut, Vintage Gold, Mahogany, & Mocha Includes Mounting Rails and Signage	30" W X 46" H
2016SREDK	<b>Select Rustic Elegance Wall Display</b> Features: 3 - 1 3/8" Poles; 3 - 2 1/4" Poles; 9 Decorative Finial & 2 End Cap Designs 6 Finishes - Charcoal, Pecan, English Chestnut, Natural, American Walnut, & Espresso Includes Mounting Rails and Signage	30" W X 46" H
2016SRTDK	<b>1 3/8" &amp; 2 1/4" Select Rustic Elegance Traverse Rod Wall Display</b> Features: 2 - 2 1/4" Rods; 2 - 1 3/8" Rods, & 1 Flat Fascia Rod & Plain Premium Traverse Rod 9 Finial Designs, 2 End Cap Designs, & Mitered Returns 5 Finishes - Charcoal, Pecan, English Chestnut, American Walnut, & Espresso Includes Mounting Rails and Signage	30" W X 46" H
2016STDK	<b>1 3/8" &amp; 2 1/4" Select Wood Traverse Rod Wall Display</b> Features: 1 - 3" Rod; 2 - 2 1/4" Rods; 1 - 1 3/8" Rod, & 2 Flat Fascia Traverse Rods 9 Finial Designs, 2 End Cap Designs, & Mitered Returns 6 Finishes - Platinum, Antique Pewter, Mocha, Linen, Bronze, & Black Walnut Includes Mounting Rails and Signage	30" W X 46" H
2016SDR	<b>Select Wall Display Rails</b> - Includes 12 Black Mounting Blocks	37 1/2" H

