



TOTAL AUTOMOTIVE
LIFTING SOLUTIONS INC.



TOTAL AUTOMOTIVE
LIFTING SOLUTIONS INC.



**x4 POST
OPEN/CLOSED
FRONT
WHEEL ALIGNMENT
OR SERVICE LIFTS**

**15,000 LB. 4 POST
ALIGNMENT LIFTS**



**15,000 LB. 4 POST HEAVY DUTY
PLATFORM “OPEN” OR CLOSED
FRONT ALIGNMENT LIFTS**
100% MADE IN NORTH AMERICA



TLS415ALOXR1

TLS415ALCRX1

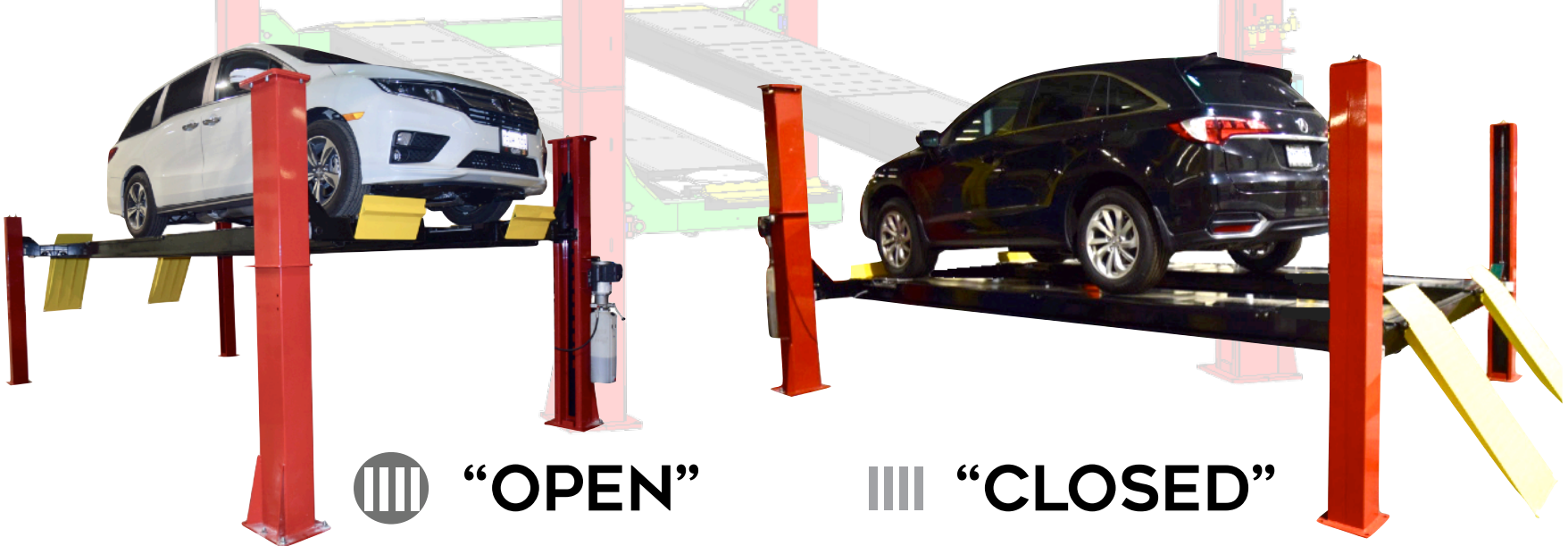

“OPEN”



“CLOSED”



15,000 LB. 4 POST PLATFORM
“OPEN FRONT” ALIGNMENT LIFTS
100% MADE IN NORTH AMERICA



TLS415ALOXR1



ADJUSTABLE FRONT ARMS

CAMBER NEUTRAL TECHNOLOGY

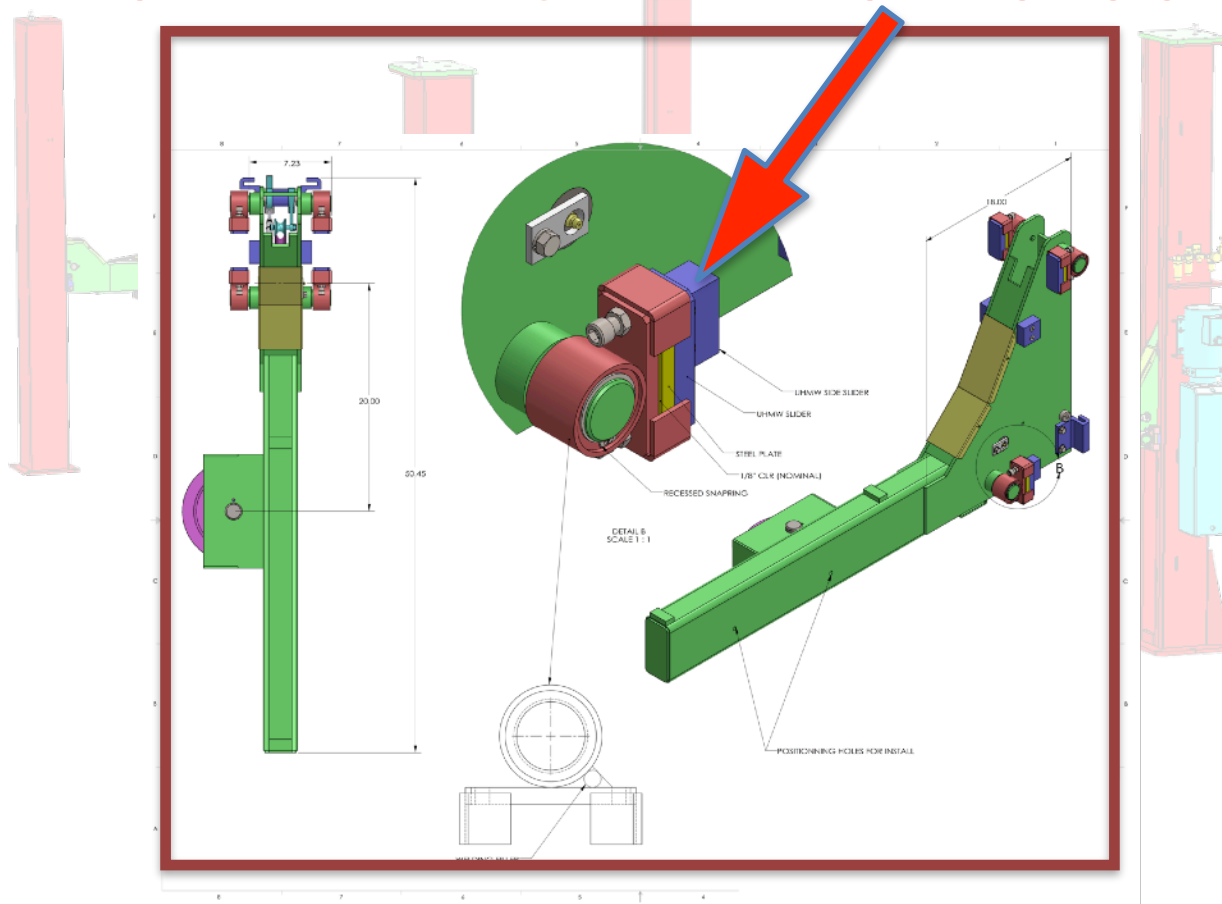

UNIQUE ADJUSTABLE ARM DESIGN

CAMBER NEUTRAL TECHNOLOGY

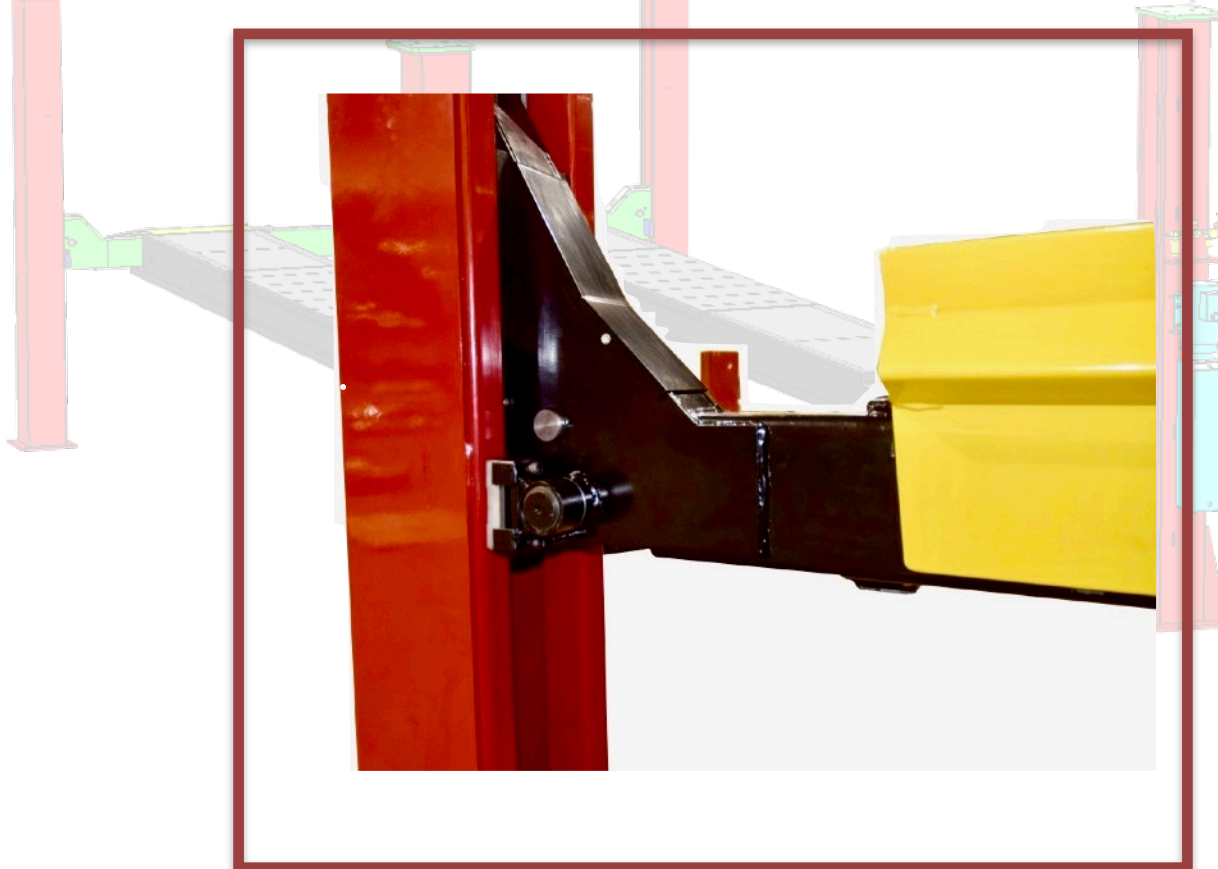

FOUR POST OPEN FRONT



CAMBER NEUTRAL TECHNOLOGY

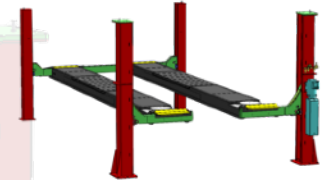

DESIGN FEATURES :

- * NO FRONT TRAVERSE BEAM OBSTRUCTION
- * PRECISE ALIGNMENT READINGS
- * LOW MAINTENANCE COSTS - LARGER DOUBLE STACKED PULLEYS & CABLES LAST LONGER
- * FIELD REPLACEABLE FRONT BEARINGS

AUTOMOTIVE AND LIGHT TRUCK GENERAL SERVICE
100% DESIGNED AND BUILT IN NORTH AMERICA

THE ONLY 4 POST WITH "CAMBER NEUTRAL" TECHNOLOGY

"OPEN FRONT" 4 POST ALIGNMENT OR SERVICE 15,000 LB. / 6.8T CAPACITY

THE TLS DIFFERENCE

- PREMIUM 1/2" (12.3MM) CABLES / 9" (229MM) MACHINED STEEL PULLEYS
- RUNWAYS LIFT HIGHER & COLLAPSE LOWER
- PREMIUM POWDER COAT & GREASE FITTINGS AT ALL PULLEY PINS
- LEVEL NON FLEX DOUBLE WALL RUNWAYS WITH "Z" RAILS
- BUILT IN NORTH AMERICA WITH PREMIUM COMPONENTS



TLS415ALOXR1

"CAMBER NEUTRAL" TECHNOLOGY - ADJUSTABLE ARM BEARINGS
PATENT PENDING

OPTIONAL ACCESSORIES



▲ Heavy duty 7,500 lb. (3.4T) Jacking beam
TLS-RJ75HD 5 yr. parts warranty

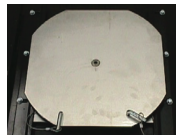

▲ Stainless Steel Turnplates TLSSTP

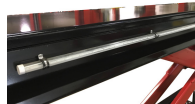

▲ Shatterproof 24V LED Lighting kit shuts off automatically before reaching the floor #TLSLED

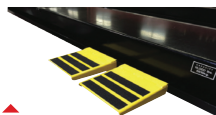

▲ Removeable Runway Step Platforms with non slip surface #TLSMWS



4 POST ALIGNMENT
15,000 LB./ 6.8T CAPACITY

ALIGNMENT OR GENERAL SERVICE
210" OR 237" / 5.3M OR 6M LONG RUNWAYS

AT TLS WE BUILD LIFTS THAT LAST LONGER, PERFORM BETTER & COST LESS TO OPERATE

SPECIFICATIONS

Capacity	15,000 lbs / 6.8T
Overall Length Extended Model	287 1/2" / 7303 mm
Overall Length Standard Model	260 1/2" / 6617 mm
Deck Length Extended Model	238" / 6045mm
Deck Length Standard Model	211" / 5359mm
Overall Width	143" 3632mm front /137 1/2" / 3493mm rear
Deck Width	23" / 584mm
Lowered Height	8 3/8" / 267mm
Raised Height	75" / 1905mm
Min. 4 Wheel Align. WB	84" / 2134mm
Max. 4 Wheel Align. WB	164-1/2" / 4178mm
Max. 2 Wheel Align. WB	209" or 182" / 5309mm or 4623mm
Max. Service WB	220" or 193" / 5588mm or 4902mm
Lift Time	70 seconds
Power Requirement	230V - 60Hz - 1 Ph - 20amp
Shipping Weight	5,000 lb. / 2.3T
Part Number	TLS415ALOXR1 / TLS415FDOXR1

FEATURES

- Built to higher quality standard; 100% North American made - premium US Bucher 2HP / 1.5kw power unit.
- Corrosion resistant protection - steel components are wheel-abrator shot blasted and acid washed before a "double bake" powder coat finish is applied.
- Superior structural strength provides longer life and more precise alignments - Non flex double wall 23" / 584mm wide runways with built in "Z" rail. Heavy duty 10" x 8-3/8" x 1/4" wall / 254mm x 213mm x 6mm wall columns and 3" x 8-1/4" / 72mm x 210mm tube traverse beams.
- Greater flexibility with more models to choose from - Available in two runway lengths with built in wheel alignment or service deck. Lift can be ordered in red or blue.
- Premium options and accessories can expand the capabilities and service life - Stainless steel radius plates and rear steer plates, built in tire inflation hoses, removable work steps, LED runway lighting and premium long life 5 year warranty HD jacking beams
- Lower maintenance costs - Zirk style grease fittings at all 1-1/2" / 38mm plated hinge pins. Runway under rear slip plates is open to prevent water and dirt collecting. Thirty 7/8" / 22mm enclosed plated steel slip plate balls provide better support with minimal maintenance.
- Extended Life "Non Twist" Cable design - Machined steel nickel plated 9" / 229mm pulleys with bronze self lubricating bushings. Non spin fatigue resistant 1/2" / 12.3 mm cables are routed on round stacked pulleys (versus four stacked) to reduce stress and wear.
- Low pressure hydraulics provides longer life - 4" ID x 65" / 102mm ID x 1651mm cylinder is mounted under the runway and use a premium "Parker" seal and wear ring with chrome plated plunger shaft.
- Designed for optimum productivity - OPEN FRONT design provides clear access. Single point control with stainless steel cylinder air releases engage 12 locking positions. Adjustable locking ladders 81" x 2-3/4" x 3/8" / 2057mm x 70mm x 9.5mm thick allow for accurate levelling. Power

ADDITIONAL FEATURES



▲ Pulley and cables



▲ Double wall deck with Z rail

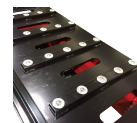

▲ Open runway slots under rear slip plates

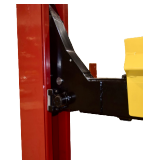

▲ "Camber Neutral" adjustable front arms

EQUIPMENT FOOTPRINT

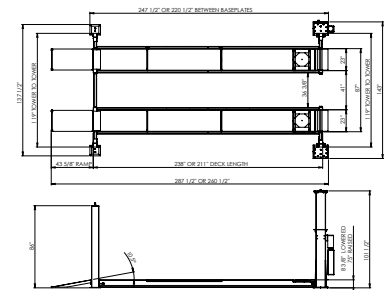

“OPEN FRONT” STANDARD OR EXTENDED

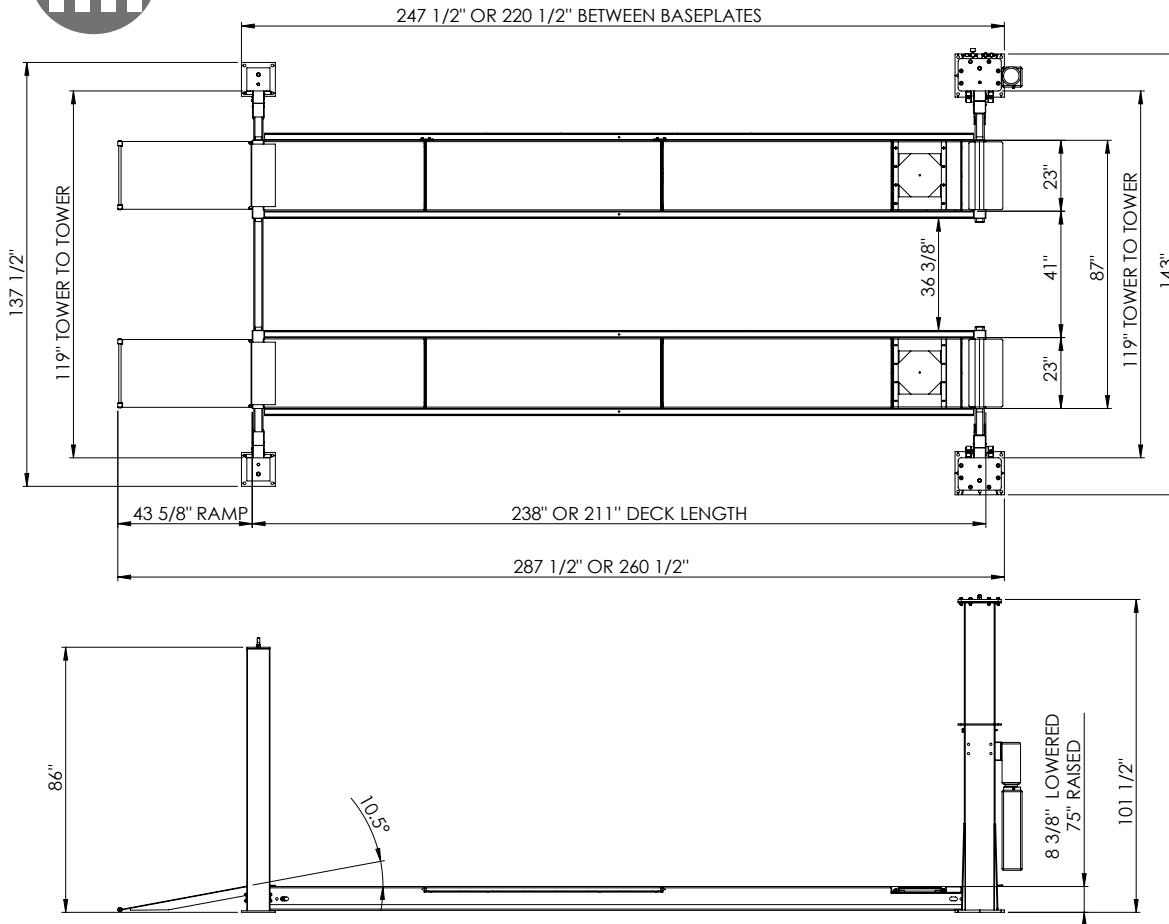

TLS415ALOXR1

IDEAL WORKING DIMENSIONS
RAISED HEIGHT 74", LOWERED
HEIGHT 8 3/8"- 4 WHEEL
ALIGNMENT - 84" TO 164 1/2"
2 WHEEL ALIGNMENT -
182" TO 209"

“OPEN FRONT” SPECIFICATIONS

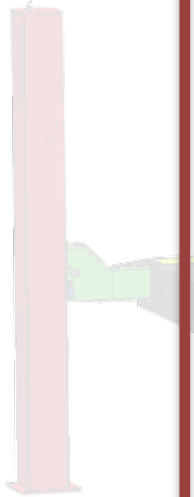

SPECIFICATIONS	
Capacity	15,000 lbs / 6.8T
Overall Length Extended Model	287 1/2" / 7303 mm
Overall Length Standard Model	260 1/2" / 6617 mm
Deck Length Extended Model	238" / 6045mm
Deck Length Standard Model	211" / 5359mm
Overall Width	143" 3632mm front /137 1/2" / 3493mm rear
Deck Width	23" / 584mm
Lowered Height	8 3/8" / 267mm
Raised Height	75" / 1905mm
Min. 4 Wheel Align. WB	84" / 2134mm
Max.4 Wheel Align. WB	164-1/2" / 4178mm
Max. 2 Wheel Align. WB	209" or 182" / 5309mm or 4623mm
Max. Service WB	220" or 193" / 5588mm or 4902mm
Lift Time	70 seconds
Power Requirement	230V - 60Hz - 1 Ph - 20amp
Shipping Weight	5,000 lb. / 2.3T
Part Number	TLS415ALOXR1 / TLS415FDOXR1

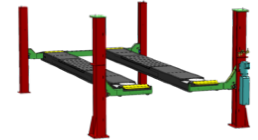
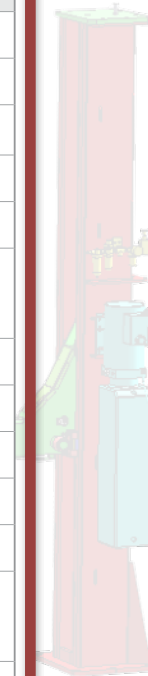

**“OPEN FRONT” RUNWAYS
23”WIDE X UP TO 238” LONG**



TLS415ALOXR1

15,000 LB. CAPACITY

143” W X 260 1/2” OR L 287 1/2”

**SHOT BLASTED STEEL -
POWDER COATED**

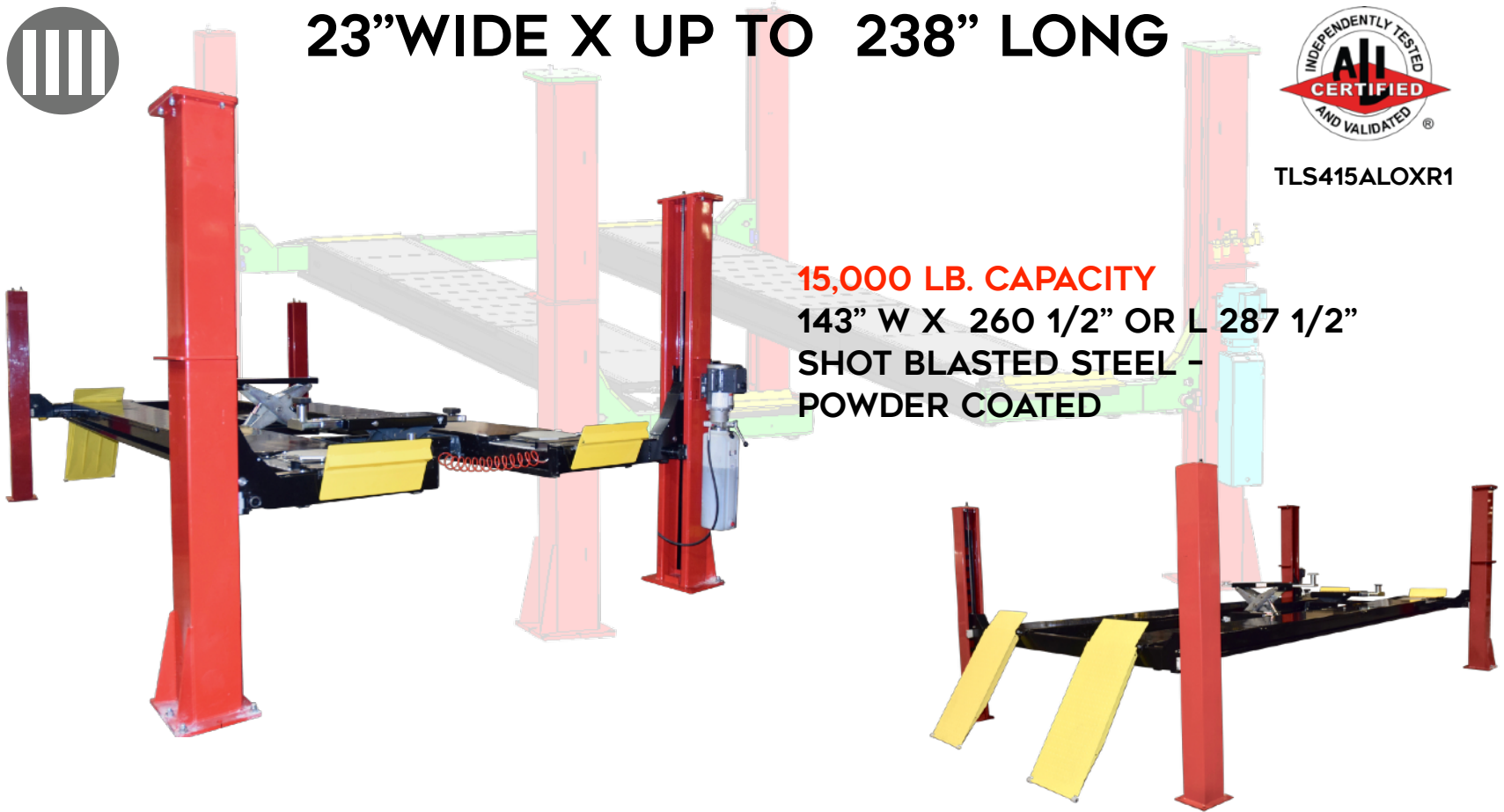



**15,000 LB. 4 POST PLATFORM
“CLOSED FRONT” ALIGNMENT LIFTS
100% MADE IN NORTH AMERICA**

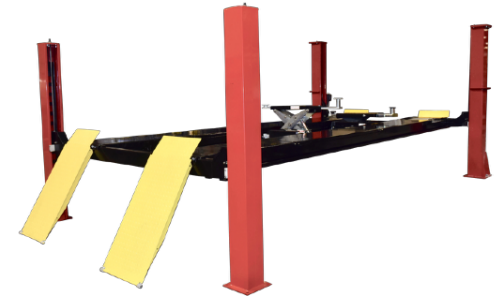

TLS415ALCRX1

FOUR POST CLOSED FRONT



**RUGGED WORK PLATFORM
FOR CARS & LIGHT TRUCKS**

DESIGN FEATURES :

- * **STRUCTURALLY STRONGER THAN COMPETITORS**
- * **TWO RUNWAY LENGTHS TO CHOSE FROM**
- * **PRECISE ALIGNMENT READINGS**
- * **LOW MAINTENANCE COSTS - LARGER DOUBLE STACKED PULLEYS & CABLES LAST LONGER**

LIGHT DUTY 4 POST ALIGNMENT OR SERVICE 15,000 LB. / 6.8T CAPACITY

THE TLS DIFFERENCE

- PREMIUM 1/2" (12.3MM) CABLES / 9" (229MM) MACHINED STEEL PULLEYS
- RUNWAYS LIFT HIGHER & COLLAPSE LOWER
- PREMIUM POWDER COAT & GREASE FITTINGS AT ALL PULLEY PINS
- LEVEL NON FLEX DOUBLE WALL RUNWAYS WITH "Z" RAILS
- BUILT IN NORTH AMERICA WITH PREMIUM COMPONENTS



OPTIONAL ACCESSORIES



Heavy duty 7,500 lb. (3.4T) Jacking beam
 TLS-RJ75HD 5 yr. parts warranty

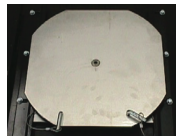

Stainless Steel Turnplates TLSSTP

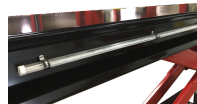

Shatterproof 24V LED Lighting kit shuts off automatically before reaching the floor
 #TLSLED

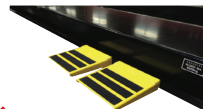

Removeable Runway Step Platforms with non slip surface #TLMWS



4 POST ALIGNMENT
 15,000 LB. / 6.8T CAPACITY

ALIGNMENT TLS415ALCRx1 / EXTENDED TLS415ALCXx1
 SERVICE TLS415FDCRx1 / EXTENDED TLS415FDCXx1

AT TLS OUR GOAL IS TO BUILD LIFTS THAT LAST LONGER, PERFORM BETTER AND COST LESS TO OPERATE

SPECIFICATIONS

Capacity	15,000 lbs / 6.8T
Overall Length Extended Model	285" / 7239 mm
Overall Length Standard Model	258" / 6553 mm
Deck Length Extended Model	238" / 6045mm
Deck Length Standard Model	211" / 5359mm
Overall Width	137 1/2" / 3493mm
Deck Width	23" / 584mm
Lowered Height	8 3/8" / 213mm
Raised Height	75" / 1905mm
Min. 4 Wheel Align. WB	84" / 2134mm
Max. 4 Wheel Align. WB	164-1/2" / 4178mm
Max. 2 Wheel Align. WB	209" or 182" / 5309mm or 4623mm
Max. Service WB	220" or 193" / 5588mm or 4902mm
Lift Time	70 seconds
Power Requirement	230V - 60Hz - 1 Ph - 20amp
Shipping Weight	4,750 lb. / 2.2T
Part Number	TLS415ALOXR1 / TLS415FDOXR1

FEATURES

- Built to higher quality standard; 100% North American made - premium US Bucher 2HP / 1.5kw power unit.
- Corrosion resistant protection - steel components are wheel-a-brator shot blasted and acid washed before a "double bake" powder coat finish is applied.
- Superior structural strength provides longer life and more precise alignments - Non flex double wall 23" / 584mm wide runways with built in "Z" rail. Heavy duty 10" x 8 3/8" x 1/8" wall / 254mm x 213mm x 3.2mm wall columns and 3" x 6 x 1/4" / 72mm x 210mm x 6.4mm tube traverse beams.
- Greater flexibility with more models to chose from - Available in two runway lengths with built in wheel alignment or service deck. Lift can be ordered in red or blue.
- Premium options and accessories can expand the capabilities and service life - Stainless steel radius plates and rear steer plates, built in tire inflation hoses, removable work steps, LED runway lighting and premium long life 5 year warranty HD Jacking beams
- Lower maintenance costs - Zirk style grease fittings at all 1 1/2" / 38mm plated hinge pins. Runway under rear slip plates is open to prevent water and dirt collecting. Thirty-two 7/8" / 875mm enclosed plated steel slip plate balls provide better support with minimal maintenance.
- Extended Life "Non Twist" Cable design - Machined steel nickel plated 9" / 229mm pulleys with bronze self lubricating bushings. Non spin fatigue resistant 1/2" / 12.3 mm cables are routed on double stacked pulleys (versus four stacked) to reduce stress and wear.
- Low pressure hydraulics provides longer life - 4" ID x 65" / 102mm ID x 1651 mm cylinder is mounted under the runway and use a premium "Parker" seal and wear ring with chrome plated plunger shaft.
- Designed for optimum productivity - Single point control with stainless steel cylinder air releases engage 11 locking positions. Adjustable locking ladders 81" x 6" x 5/16" 2057mm x 70mm x 7.9 mm thick allow for accurate levelling. Power unit can be mounted on a front or rear column. Built in runway compressed air outlets front and rear

ADDITIONAL FEATURES



Pulley and cables

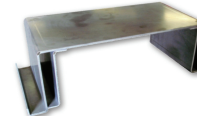

Double wall deck with Z rail

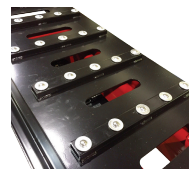

Open runway slots under rear slip plates

EQUIPMENT FOOTPRINT

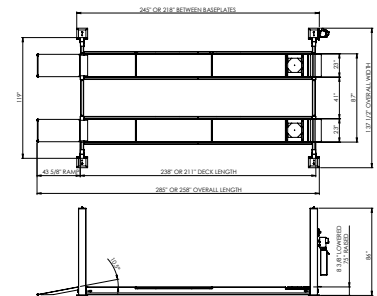

STANDARD OR EXTENDED LENGTH

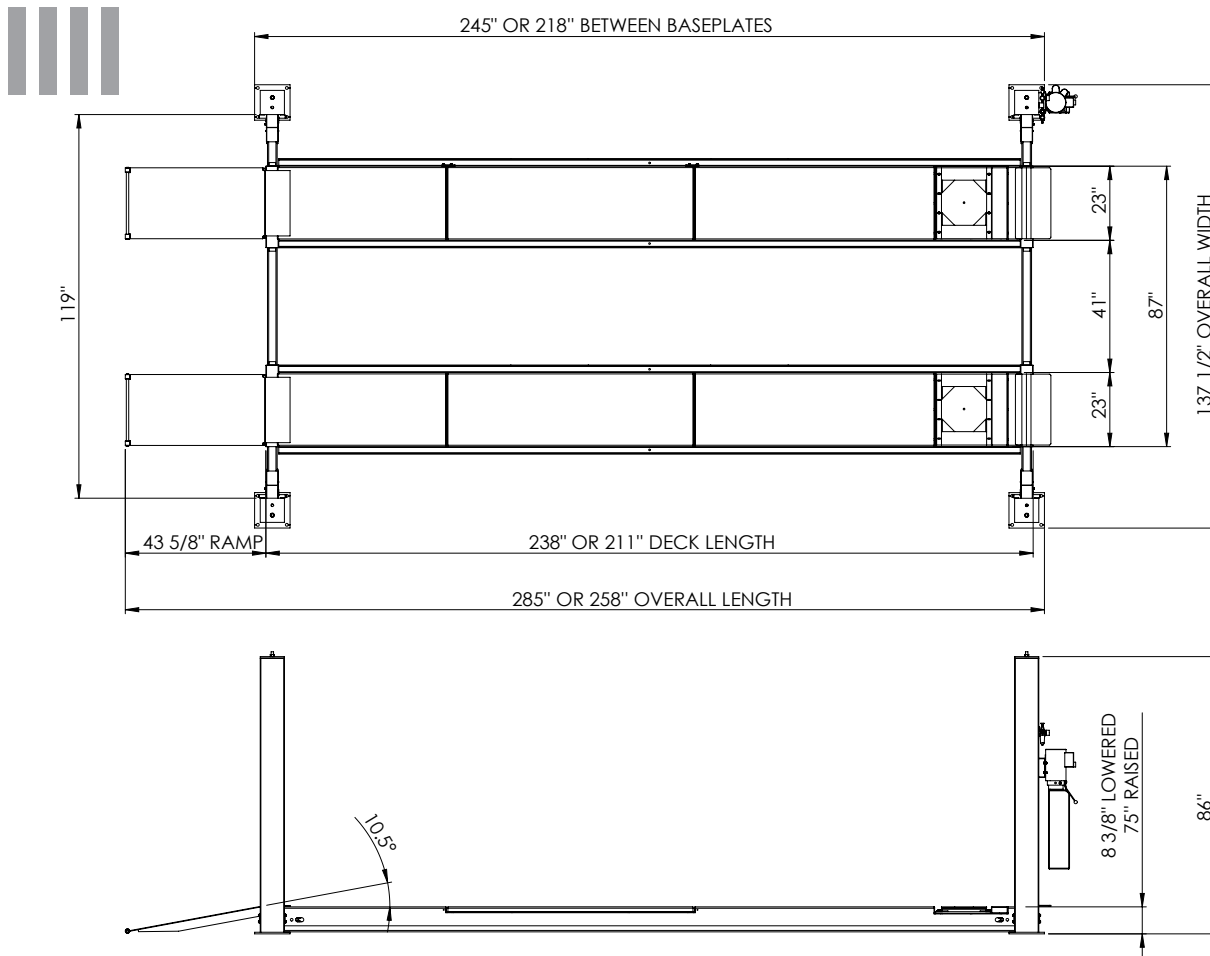

IDEAL WORKING DIMENSIONS
RAISED HEIGHT 75", LOWERED
HEIGHT 8 3/8"- 4 WHEEL
ALIGNMENT - 84" TO 164 1/2"
2 WHEEL ALIGNMENT -
182" TO 209"

TECHNICAL SPECIFICATIONS

SPECIFICATIONS	
Capacity	15,000 lbs / 6.8T
Overall Length Extended Model	285" / 7239 mm
Overall Length Standard Model	258" / 6553 mm
Deck Length Extended Model	238" / 6045mm
Deck Length Standard Model	211" / 5359mm
Overall Width	137 1/2" / 3493mm
Deck Width	23" / 584mm
Lowered Height	8 3/8" / 213mm
Raised Height	75" / 1905mm
Min. 4 Wheel Align. WB	84" / 2134mm
Max.4 Wheel Align. WB	164-1/2" / 4178mm
Max. 2 Wheel Align. WB	209" or 182" / 5309mm or 4623mm
Max. Service WB	220" or 193" / 5588mm or 4902mm
Lift Time	70 seconds
Power Requirement	230V - 60Hz - 1 Ph - 20amp
Shipping Weight	4,750 lb. / 2.2T
Part Number	TLS415ALOXR1 / TLS415FDOXR1



RUNWAYS 23" WIDE X UP TO 238" LONG



TLS415ALCRX1

15,000 LB. CAPACITY
137 1/2" W X 260 1/2" OR L
285" SHOT BLASTED STEEL -
POWDER COATED



PREMIUM **DOUBLE** BAKE POWDER COAT SURFACE PROTECTION

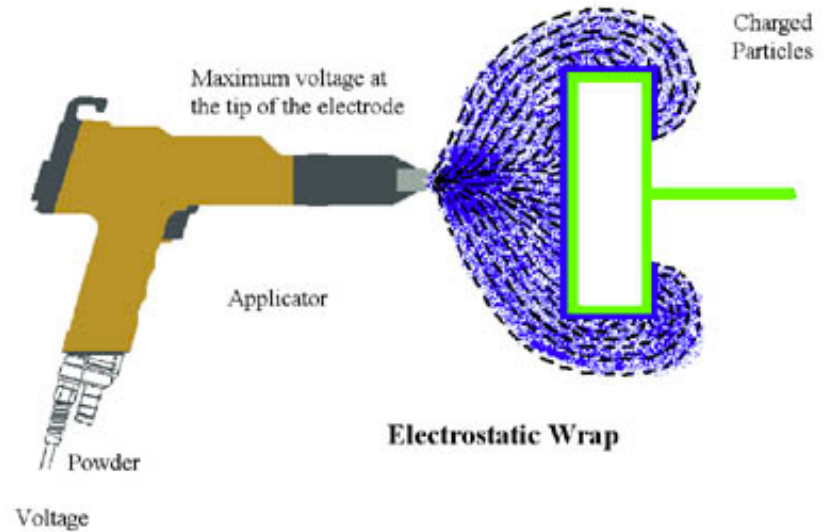
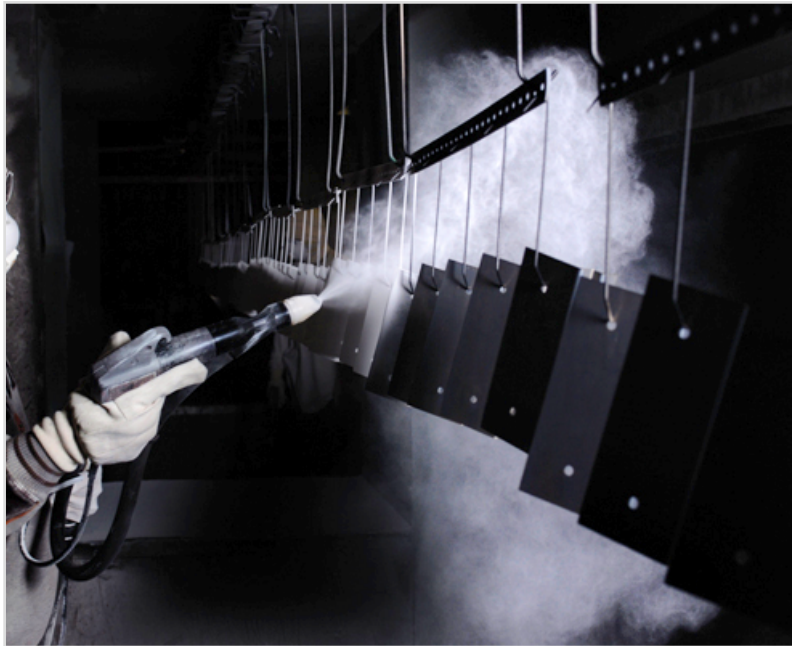

EXCLUSIVE FEATURES PREMIUM FEATURES :



**MACHINED PULLEYS
1/2" PREMIUM CABLE**



**AIR REGULATOR/OILER
WATER TRAP STANDARD**



**23" WIDE DOUBLE
WALL RUNWAYS WITH
BUILT IN "Z RAILS"**



**FLIP UP REAR SLIP
PLATE LOCKS**

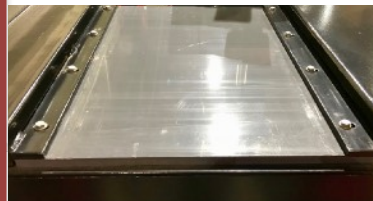

**POLYETHYLENE RADIUS
PLATE POCKET LINERS**

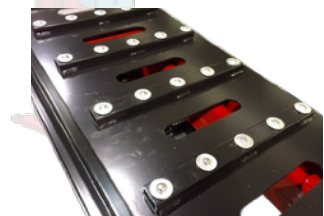

**RUNWAYS OPEN UNDER
SLIP PLATES WITH
7/8" STEEL ROLLERS**



ALI PROOF LOAD TESTING AT 22,500 LB.

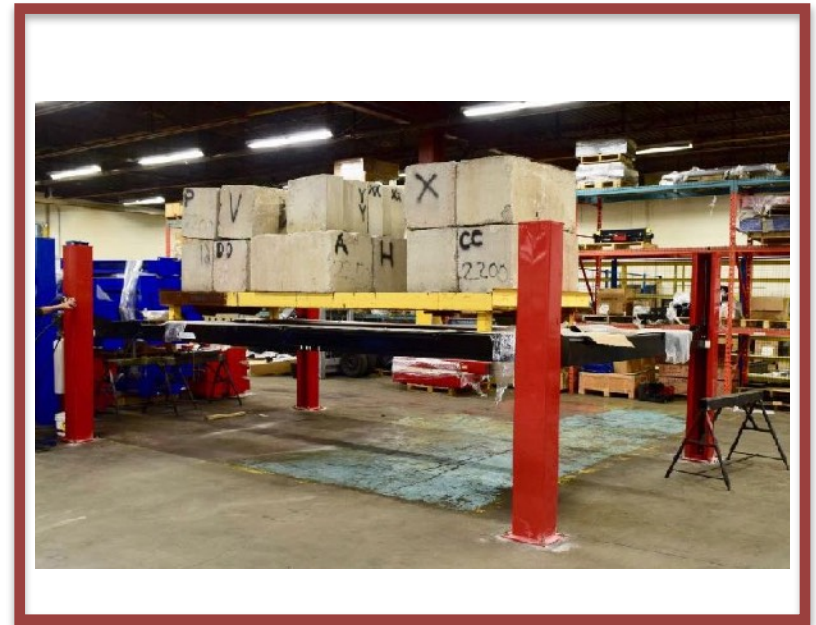



BUILT IN WHEEL ALIGNMENT PRECISE MEASURING ANY HEIGHT



TLS415ALOXR1

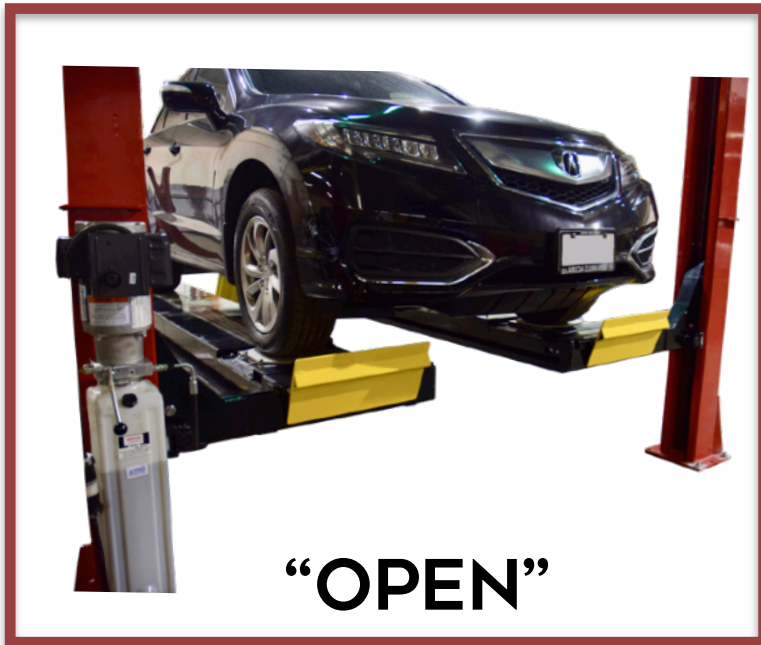

“OPEN”

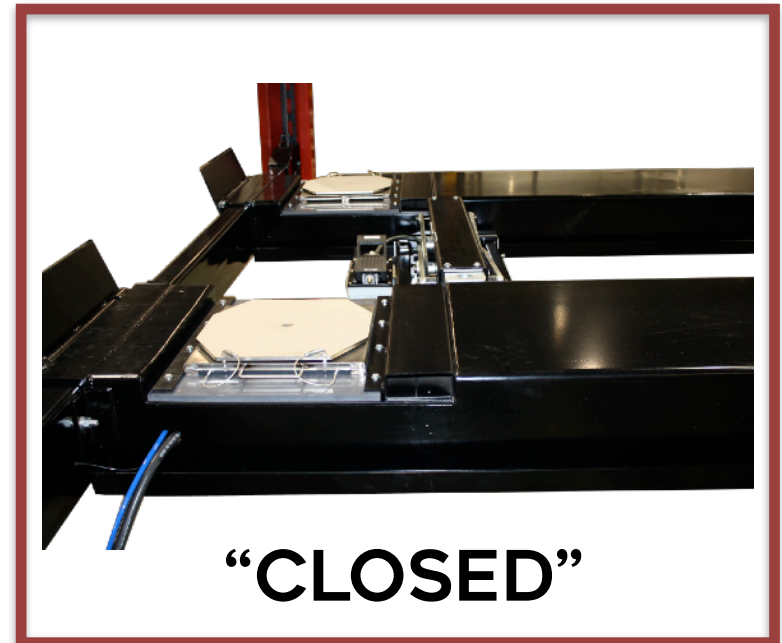

“CLOSED”

ALIGNMENT COMPATIBLE RECESSED ADJUSTABLE
PLATE POCKETS, OPTIONAL STAINLESS STEEL RADIUS
PLATES, POLYETHELENE POCKET PROTECTION &
POWDER COAT



PREMIUM MONARCH (BUCHER) US MADE POWER UNIT



TLS415ALCRX1

**NORTH AMERICAN
POWER UNIT WITH
MONARCH US MADE
220V 1 PH OPTIONAL
3 PH, REGULATOR,
WATER TRAP/OILER
STANDARD**



RETRACTABLE FLIP DOWN FRONT WHEEL STOPS



TLS415ALOXR1

OPEN FRONT ACCESS
PROPRIETARY DROP
DOWN WHEEL STOPS

REINFORCED LOW ANGLE APPROACH RAMPS



TLS415ALOXR1

TLS415ALCRX1

**DESIGNED FOR LOW
APPROACH ANGLE
48" APPROACH
RAMPS 8 3/8"
LOWERED HEIGHT
DIAMOND PLATE
WITH GUSSETS**



SELF DRAINING REAR SLIP PLATES WITH 3/4" CHROME ROLLERS

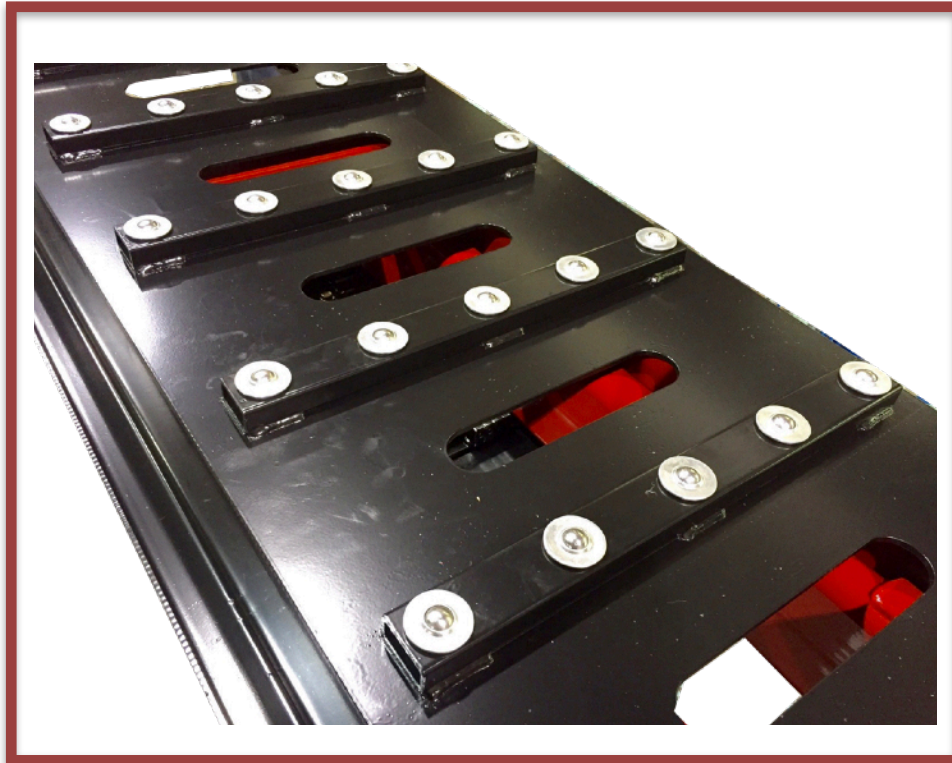

TLS415ALOXR1

TLS415ALCRX1

**PROPRIETARY
DOUBLE SHELL
RUNWAY DESIGN
INNER & OUTER
JACK TRACK 23"
DUAL WHEEL DECK**



NON SAG DOUBLE WALL RUNWAYS

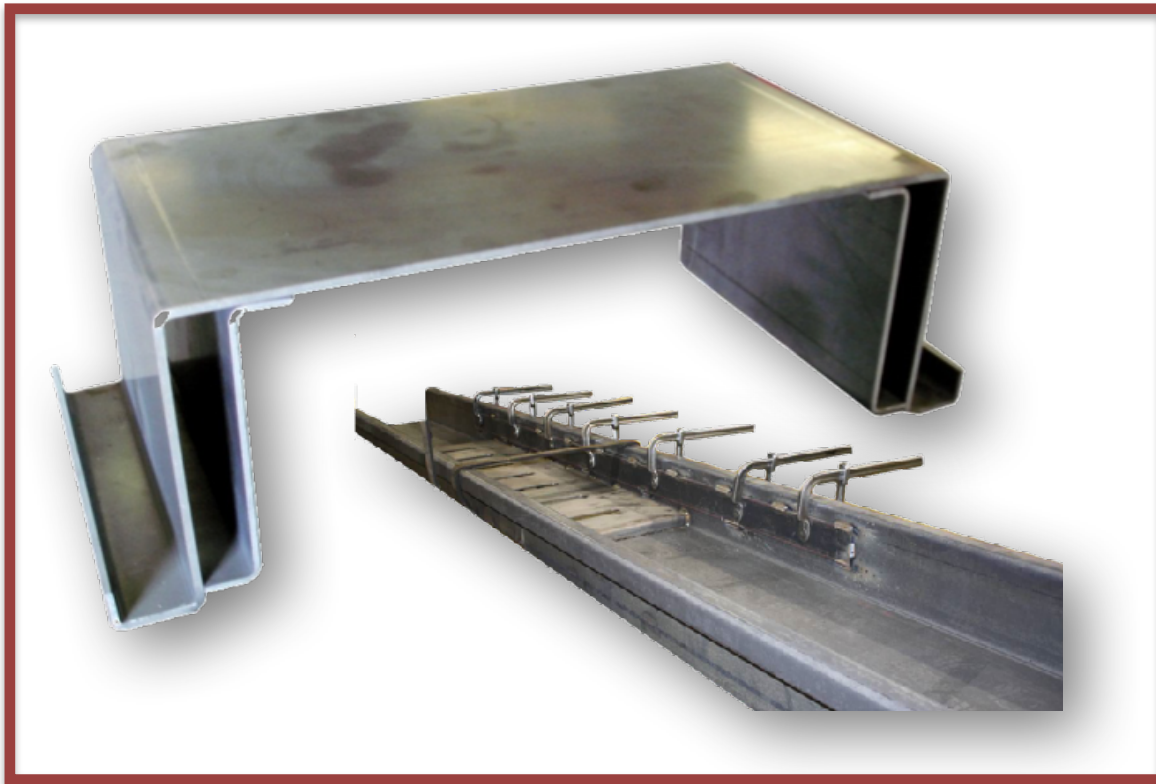

TLS415ALOXR1

TLS415ALCRX1

NON FLEX RUNWAY
DESIGN, PROPRIETARY
DOUBLE SHELL INNER &
OUTER JACK TRACK
23" WIDE DUAL WHEEL
DECK



FORMED COLUMN & CARRIAGE

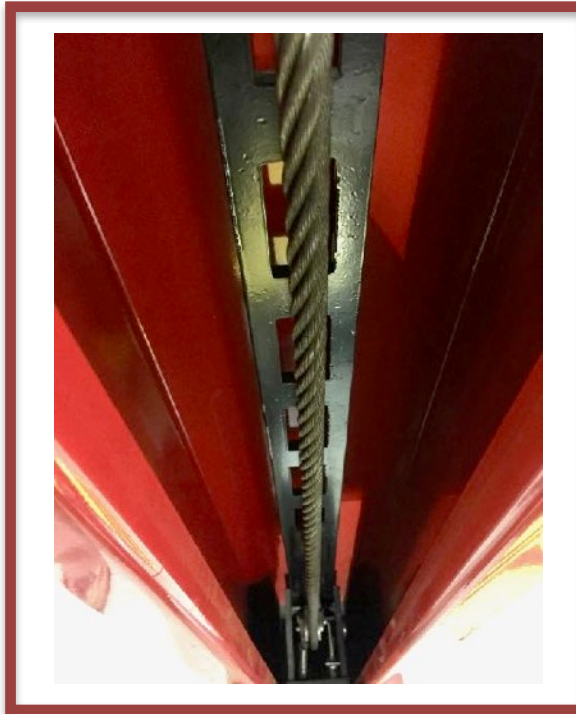
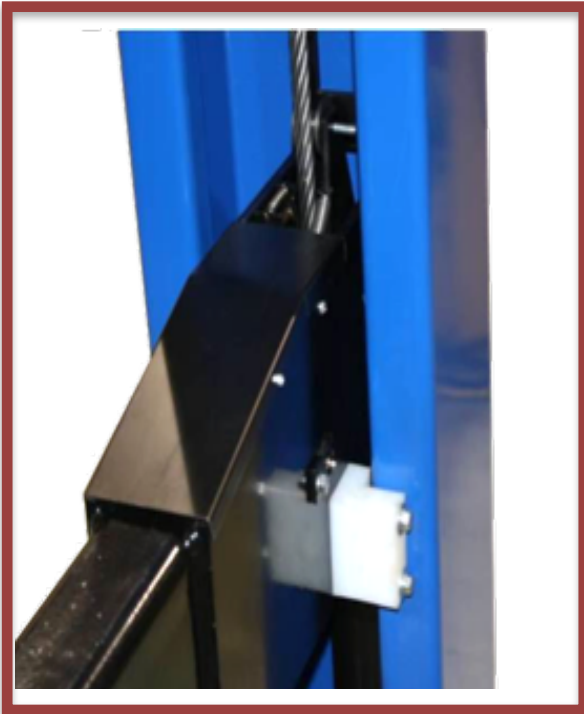

TLS415ALOXR1

TLS415ALCRX1

ADJUSTABLE LEVEL
11 POSITION
ADJUSTABLE
LOCKING LADDER
QT100 STEEL 75" TALL
X 2 1/2" WIDE X 5/16"
THICK



PREMIUM INDUSTRIAL PRE-STRESSED CABLES

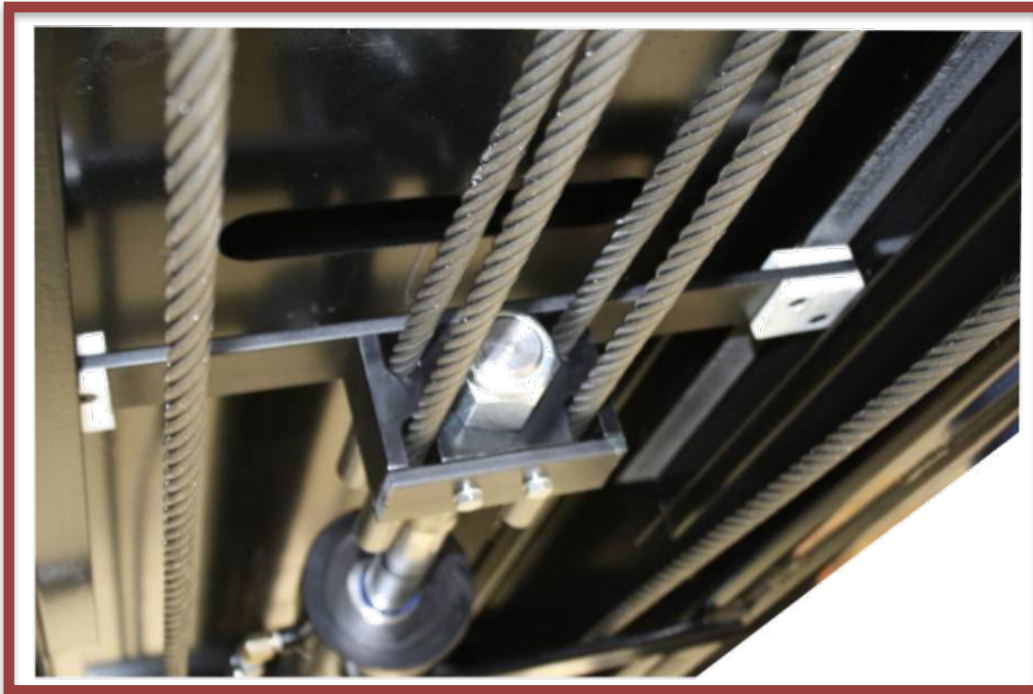

TLS415ALOXR1

TLS415ALCRX1

**1/2" PRE-STRETCHED
WIRE ROPE**

**PROPRIETARY NON
ROTATION TRUNION
DESIGN STRESS FREE
CABLE ROUTING**



PRECISION MACHINE DOUBLE STACK STEEL PULLEYS



TLS415ALOXR1

TLS415ALCRX1

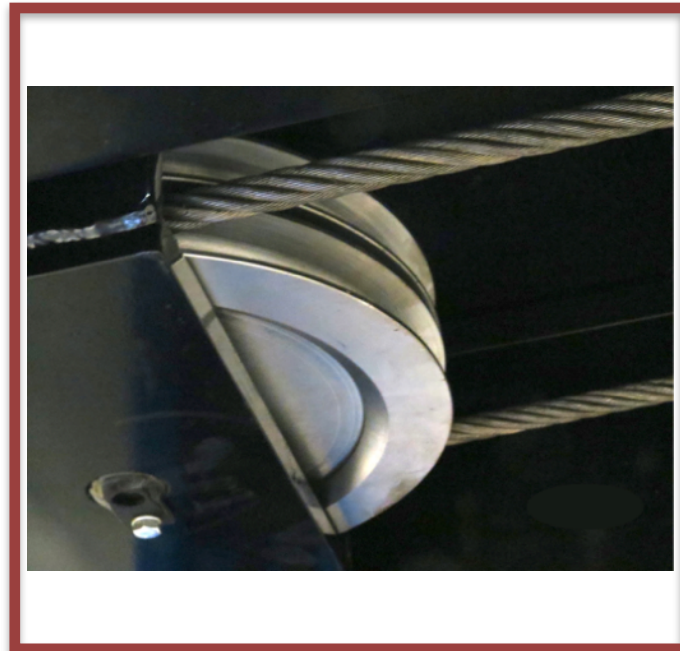

LOW MAINTENANCE
9" MACHINED
DOUBLE STACKED
STEEL PULLEYS,
BRONZE SELF
LUBRICATING OIL
LITE BEARINGS,
1/2" PRE
STRETCHED WIRE
ROPE



MORE FEATURES COME STANDARD



TLS415ALOXR1

TLS415ALCRX1

ADDED FEATURES -
GREASE FITTINGS AT
ALL HINGE POINTS &
BUILT IN RUNWAY AIR
OUTLETS



PREMIUM HYDRAULICS

NORTH AMERICAN MADE



TLS415ALOXR1

TLS415ALCRX1



PREMIUM HYDRAULICS
"PARKER" SEAL /WEAR
RING CHROME
CYLINDER ROD
VELOCITY FUSED
SAFETY LARGE 3 1/4"
ID BORE CYLINDER



PROVEN “INDUSTRIAL” **RUST PROOFING** SPRAYED INSIDE & OUTSIDE RUNWAY SURFACES



  **OIL DRAIN, WORK STEPS, RUNWAY TIRE INFLATION HOSES & LED LIGHTING**

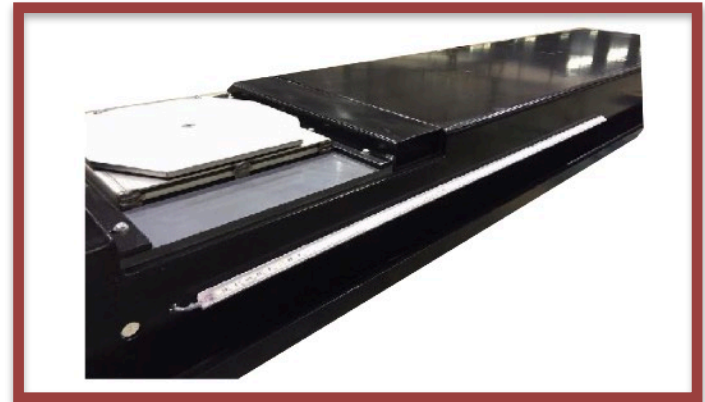
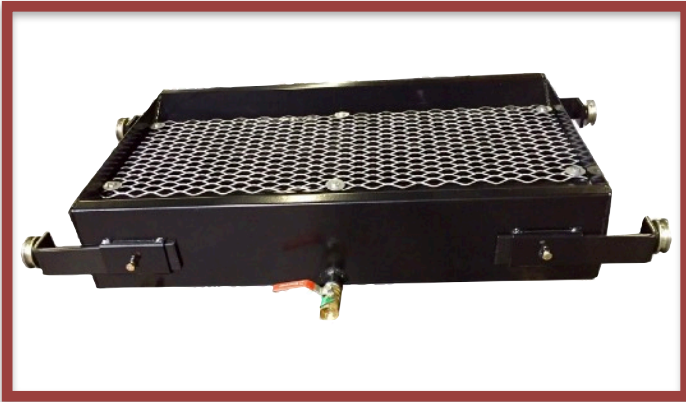

OPTIONAL ALIGNMENT LIFT OPTIONS



**PREMIUM 'HEAVY DUTY' 7,500 LB. AC
MADE IN DENMARK JACKING BEAMS
5 YR. - PARTS WARRANTY**

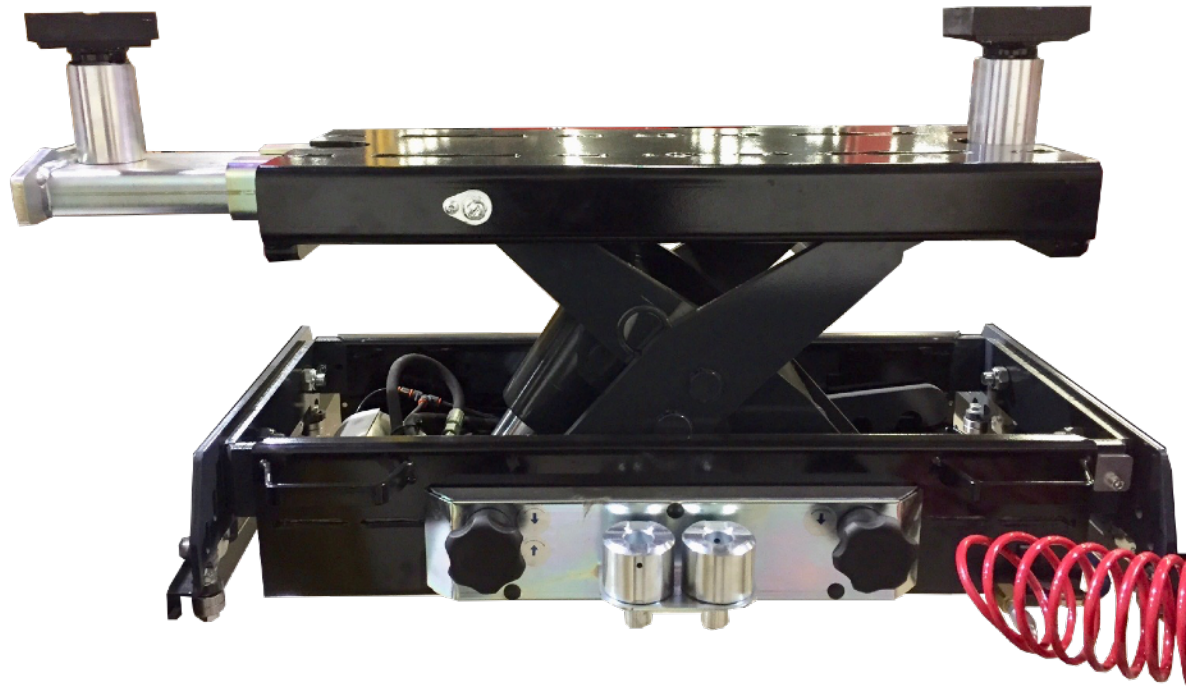



PREMIUM PLASTIC WRAPPED STEEL FRAMED SHIPPING PACKAGE



TLS415ALOXR1

TLS415ALCRX1

